



YAMAHA XSR700 HAND GUARDS

Product Reference - 13297

Kit Contents

- | | |
|-------------------------|---|
| A 1 x LH Guard | E 2 x Bar End Inners |
| B 1 x RH Guard | F 2 x Bar End Outers |
| C 1 x LH Bracket | G 2 x M8 - 20 Cap Head Bolts |
| D 1 x RH Bracket | H 4 x M4 - 10 Countersunk Screws |



Caution

Standard RH Thread

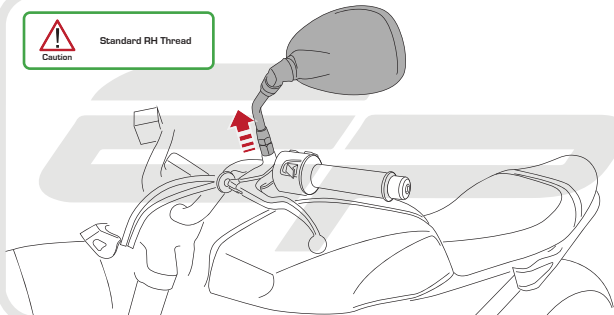

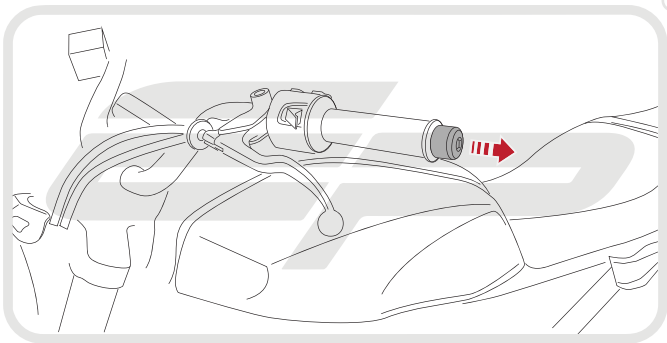

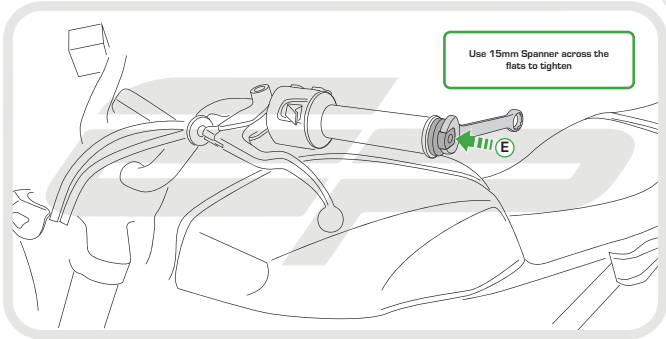
A technical line drawing of a motorcycle engine component, likely a carburetor or fuel injection system. A 15mm spanner is shown positioned across two flats on a bolt. A green arrow points to the spanner, and a green circle with the letter 'E' is next to it. The entire diagram is enclosed in a rounded rectangular frame.

Use 15mm Spanner across the flats to tighten

Only finger tight at this stage

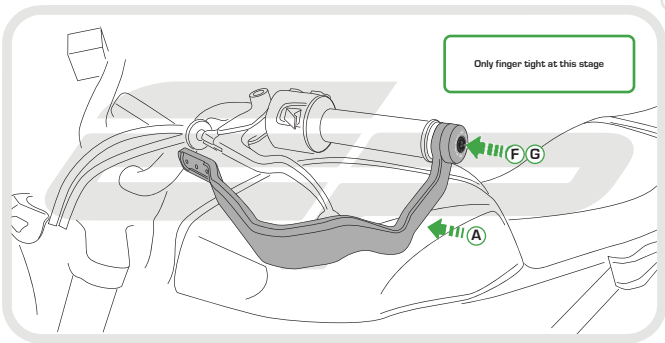

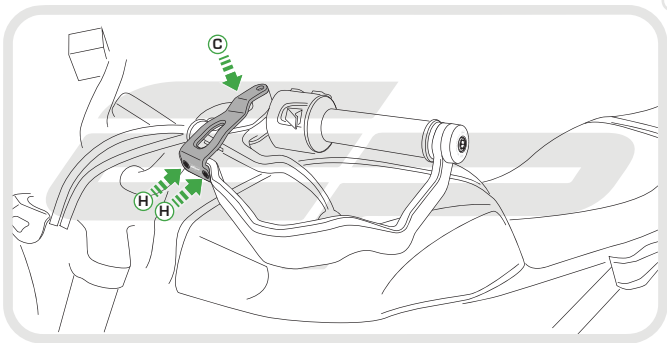



Caution

Standard RH Thread

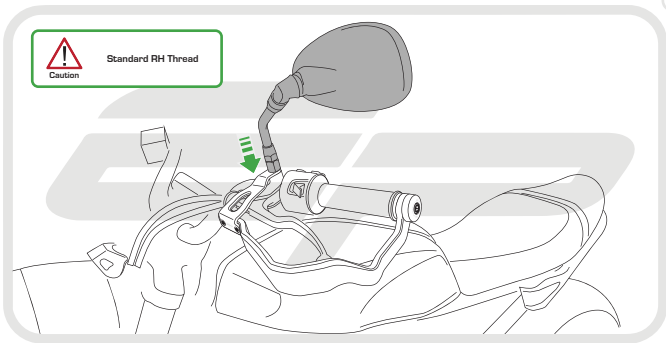

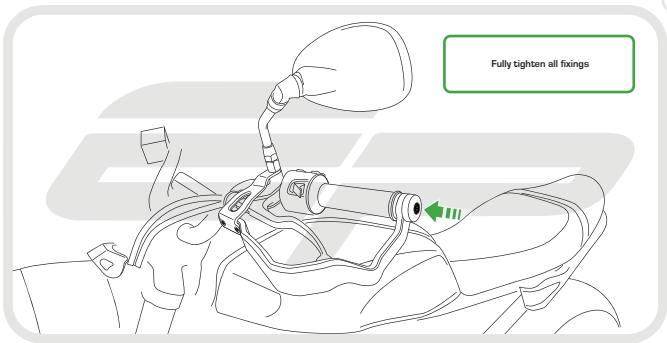

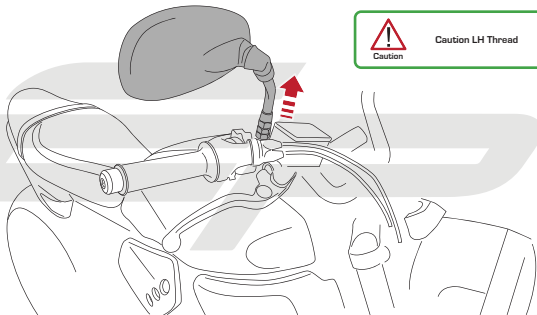

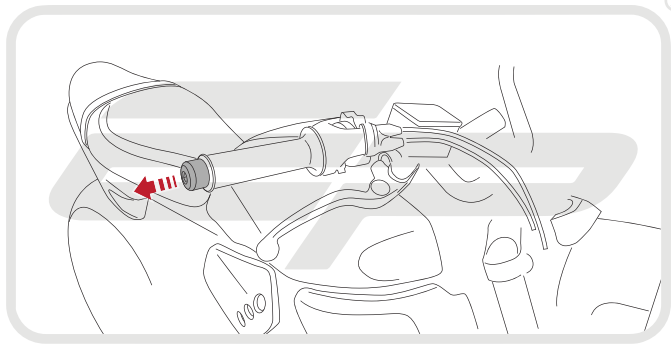

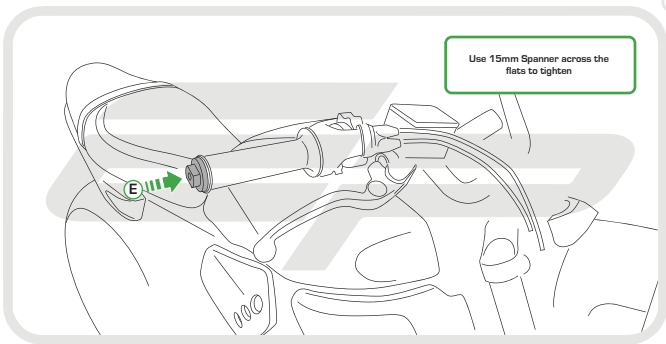

Use 15mm Spanner across the flats to tighten

The diagram shows a line drawing of a motorcycle's fuel system. A fuel line is connected to a carburetor. A callout box with a green border points to a nut on the fuel line. A green arrow labeled 'E' points to the nut. The background is a light gray with a large, faint 'EP' logo.

Only finger tight at this stage

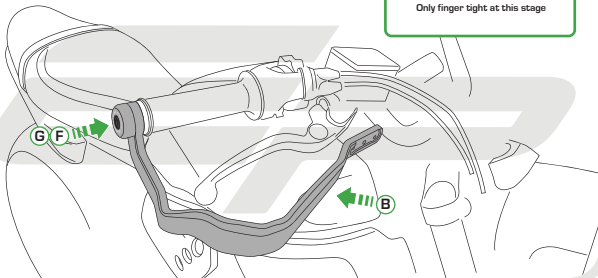

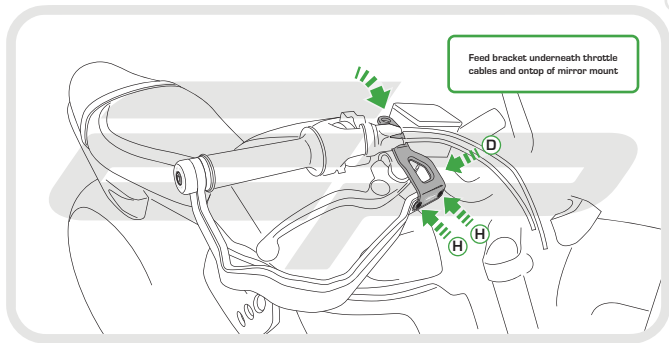

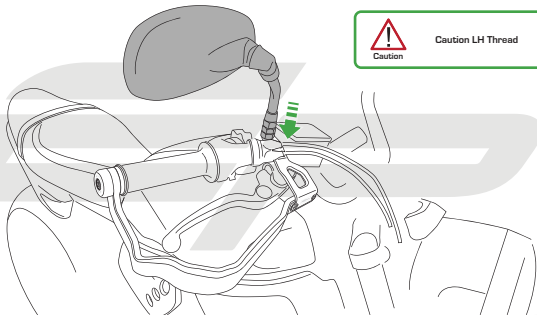

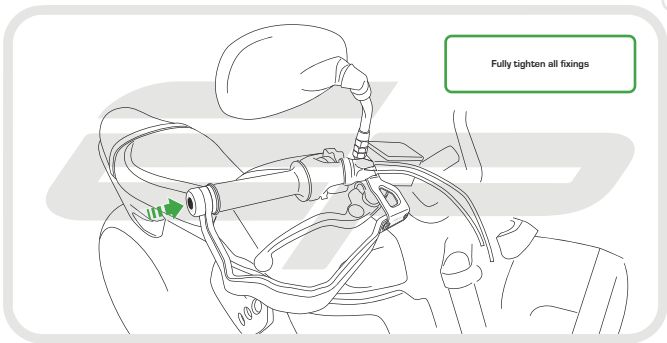

Fully tighten all fixings