



**EVOTECH**®  
P E R F O R M A N C E

**Installation Instructions**



## SUZUKI SV 650 2016 TAIL TIDY

**Product Reference - 13182**

### Kit Contents

- |   |   |
|---|---|
| <b>A</b> 1 x Main Tail Tidy                 | <b>H</b> 2 x M4 - 10 Button Head Screws |
| <b>B</b> 1 x LED Light Bracket              | <b>I</b> 2 x M3 - 12 Button Head Screws |
| <b>C</b> 1 x Spacer Plate                   | <b>J</b> 2 x Indicator Extension Wires  |
| <b>D</b> 1 x LED Light Unit                 | <b>K</b> 2 x Plastic Nuts and Bolts     |
| <b>E</b> 1 x Licence Plate Wiring Connector | <b>L</b> 2 x Bullet Connectors          |
| <b>F</b> 2 x M6 - 20 Button Head Screws     | <b>M</b> 5 x Cable Ties                 |
| <b>G</b> 2 x M6 - 16 Button Head Screws     |   |

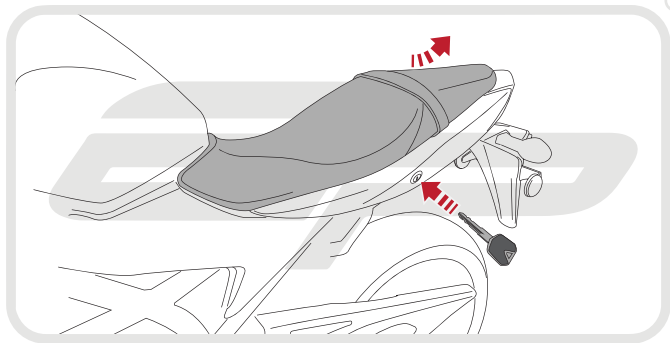

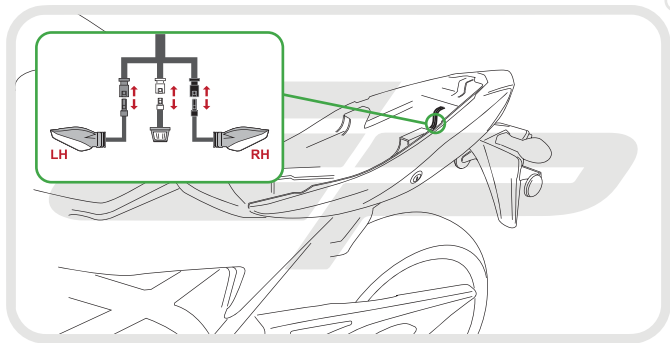

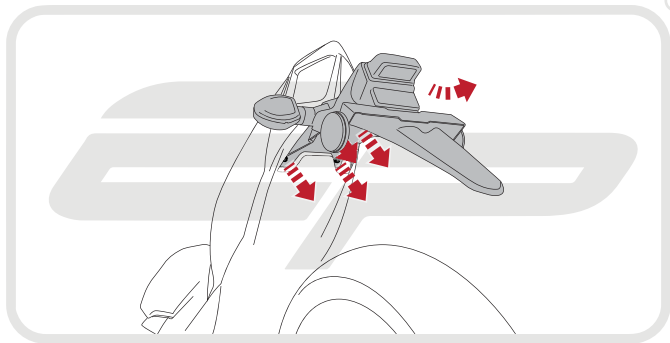

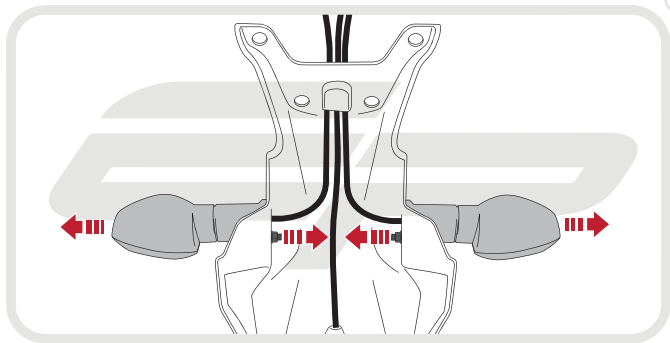

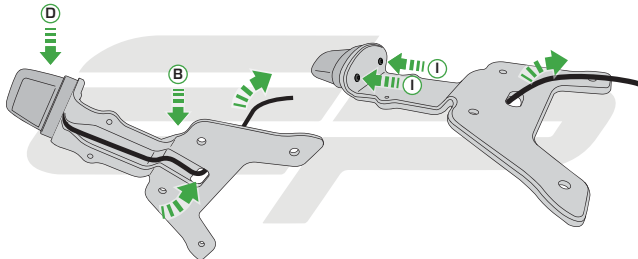



Caution

Ensure indicators are installed  
on the correct sides.  
Drain holes should be visible  
in the orientation shown.

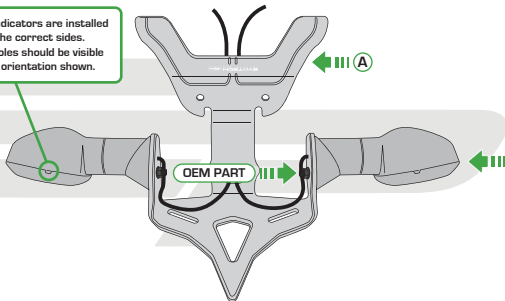





Feed cable tie through tail tidy  
so the head sits inside the  
slot on the outer face

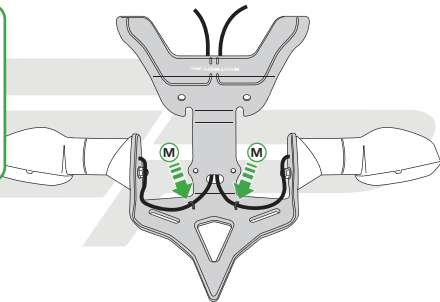

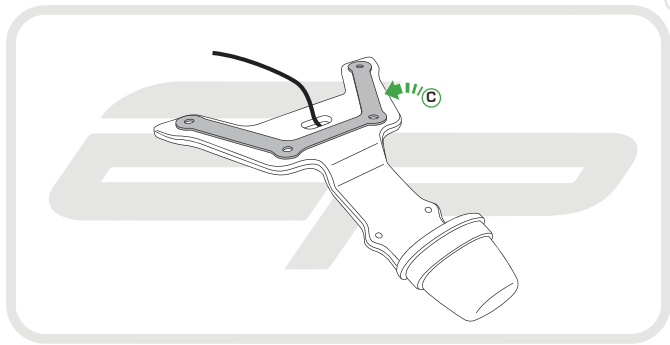

**EVOTECH**<sup>®</sup>  
P E R F O R M A N C E



Caution

Ensure spacer bracket shown  
in stage 8 remains in  
place whilst installing

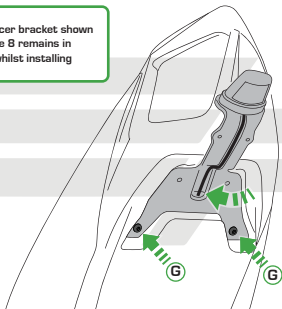

Feed wire through the hole in the  
bracket and into the under-seat  
area of the motorcycle



Caution

Run wires neatly down the channel in both parts ensuring they do not get trapped or squashed

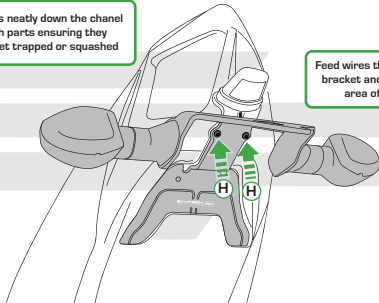

Feed wires through the hole in the bracket and into the under-seat area of the motorcycle

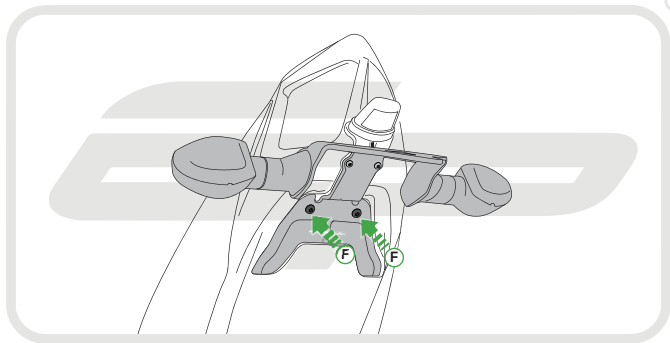

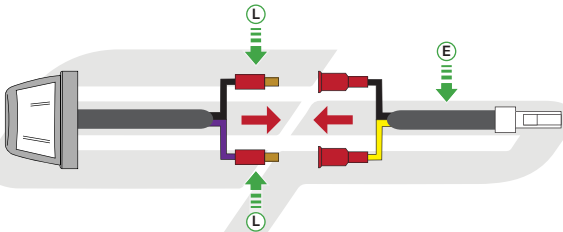

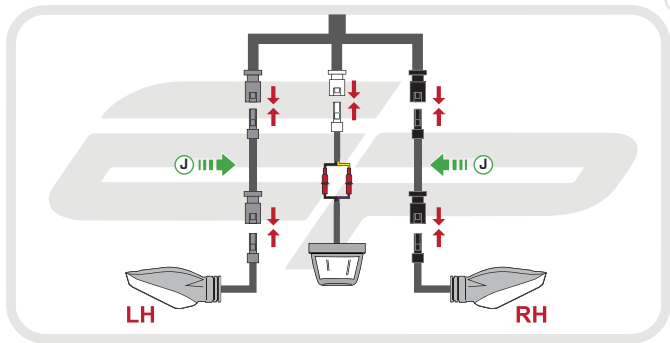



Reverse Stage 1



## Reflector Bracket Installation

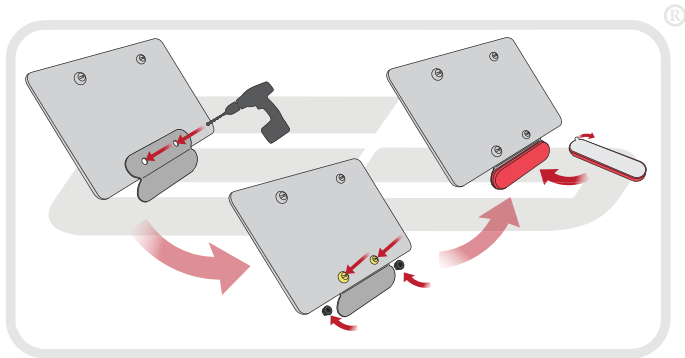

**EVOTECH**<sup>®</sup>  
P E R F O R M A N C E



## ESSENTIAL CHECKS



After installation of your tail tidy ensure that the licence plate does not contact the rear tyre when suspension is fully compressed.

Ensure all electrics including indicators, tail light, brake light and licence plate light lights are working correctly before riding the motorcycle.

It is recommended that periodic inspections are made to ensure that all fixings are fully tightend.



**EVOTECH**®  
P E R F O R M A N C E

[www.evotech-performance.com](http://www.evotech-performance.com)