



EVOTECH®
P E R F O R M A N C E

Installation Instructions



KAWASAKI Z300 TAIL TIDY

Product Reference - 12758

Kit Contents

- | | |
|--------------------------------|--|
| A 1 x Main Tail Tidy | H 2 x M3 - 12 Socket Button Head Screws |
| B 1 x LED Light Unit | I 2 x Male Bullet Connectors |
| C 1 x Light Bracket | J 2 x Plastic Screws and Nuts |
| D 1 x M4 Flange Nut | K 4 x M6 - 25 Socket Button Head Screws |
| E 1 x Wiring Connector | L 4 x M6 Flange Nuts |
| F 1 x Reflector Bracket | M 4 x M6 Washers |
| G 1 x Reflector | N 5 x Cable Ties |

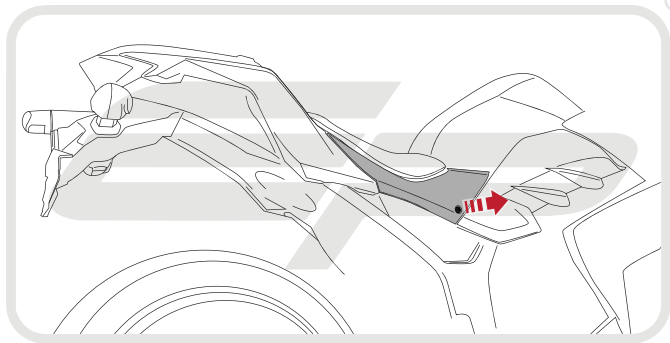

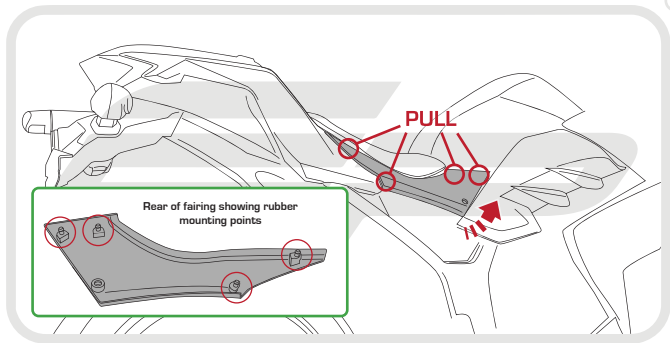

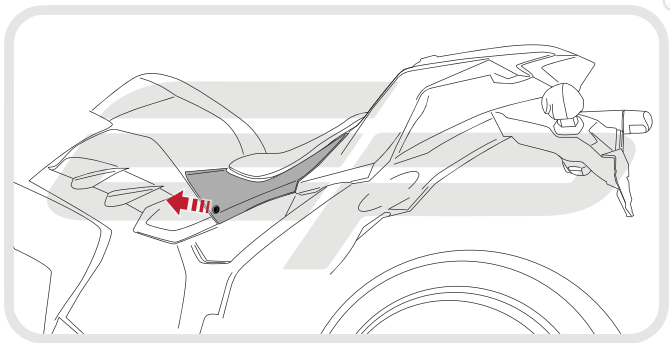

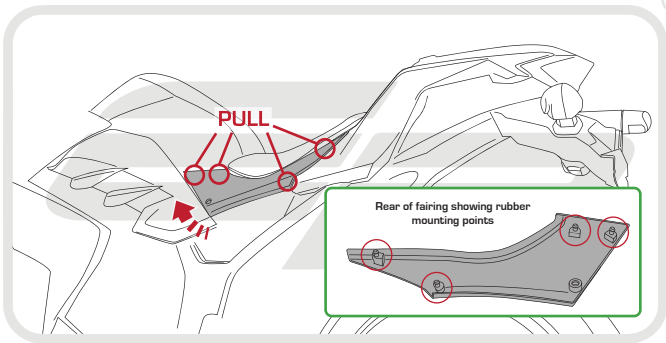

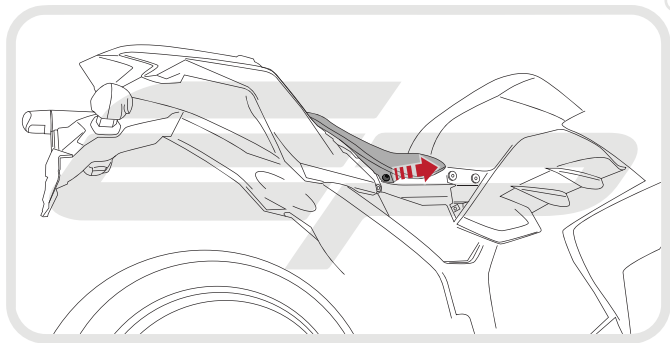

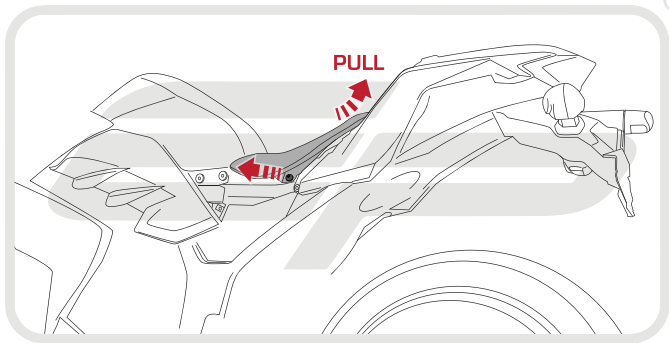

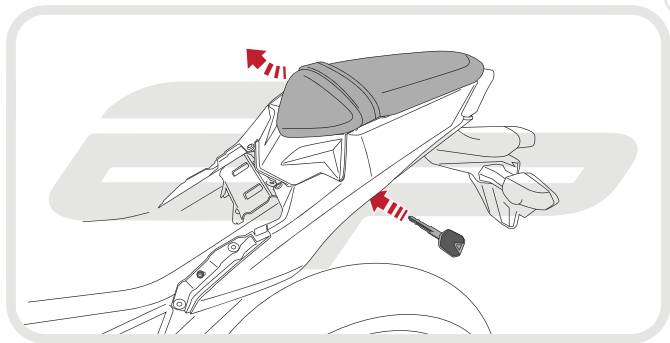

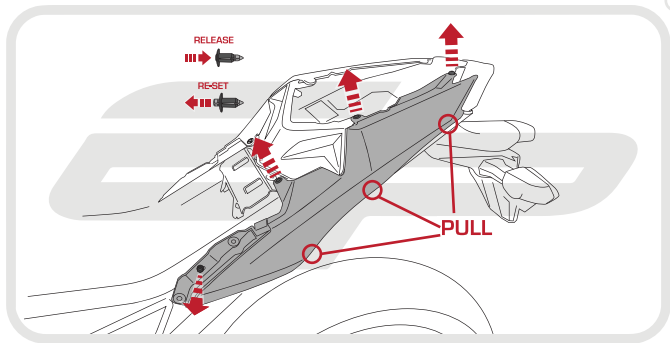

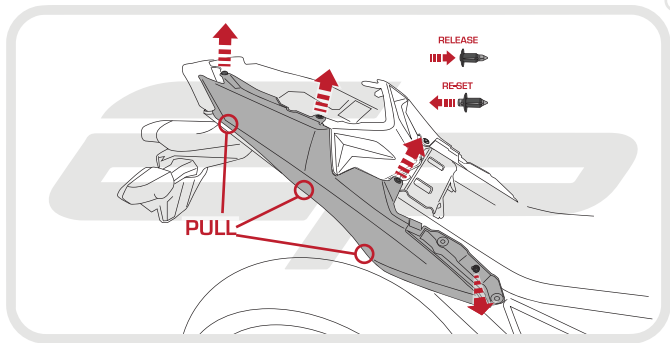

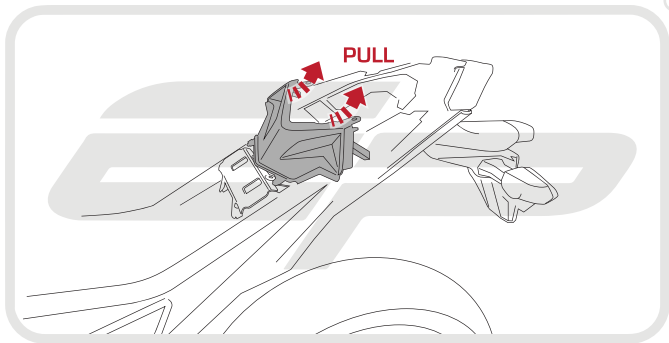

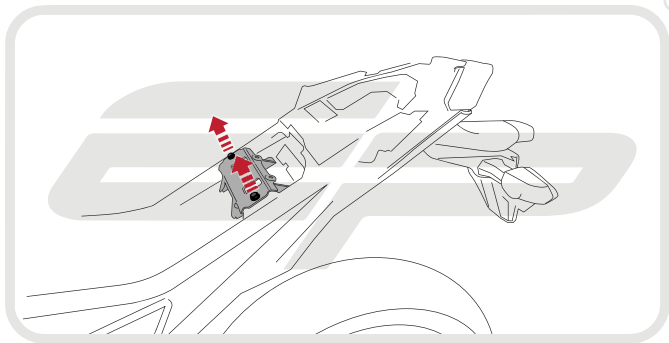

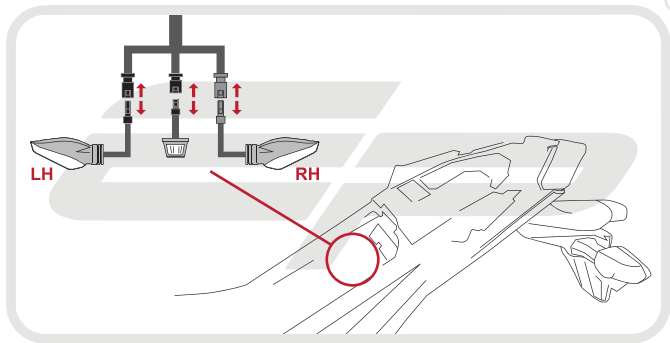

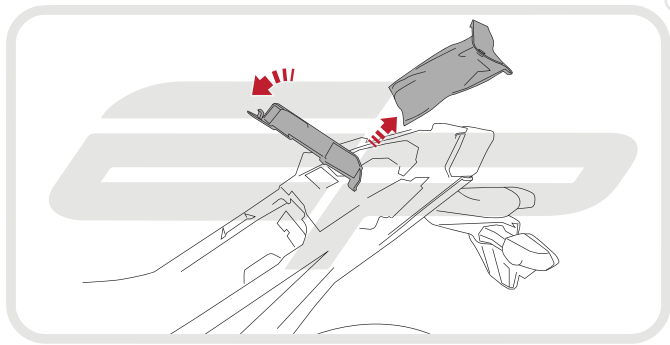

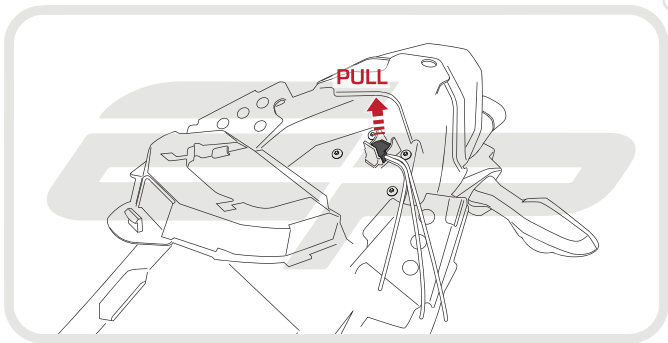

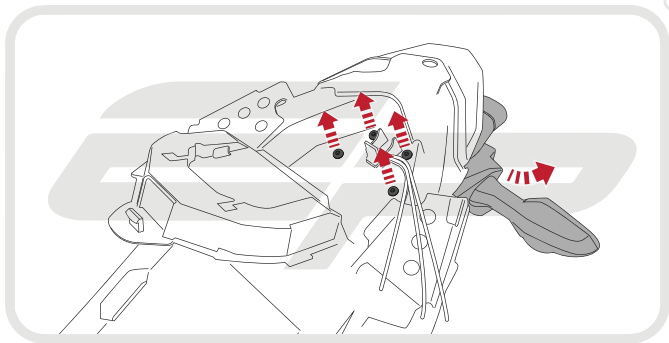

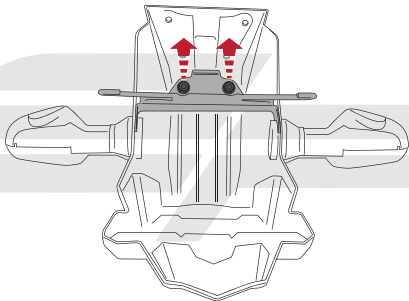

Remove Left and Right hand indicators

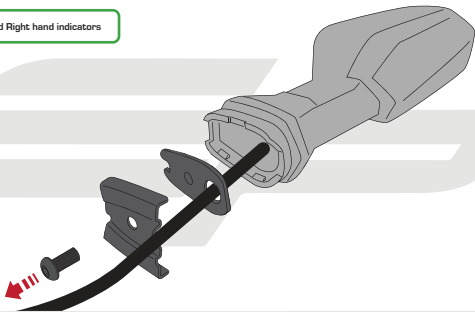

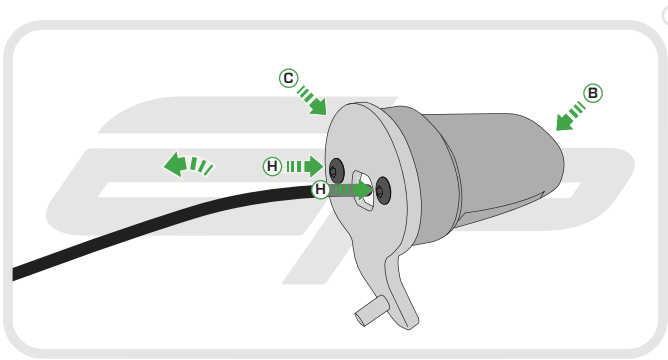

EVOTECH[®]
P E R F O R M A N C E

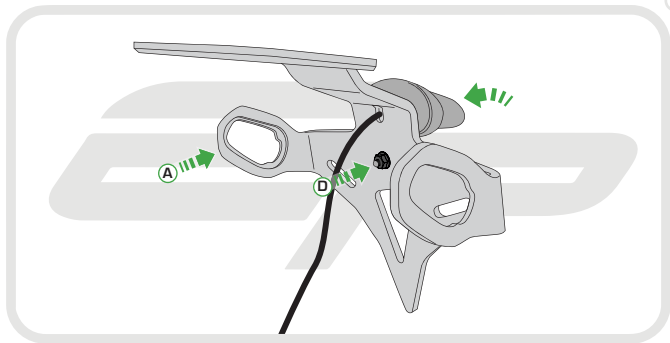

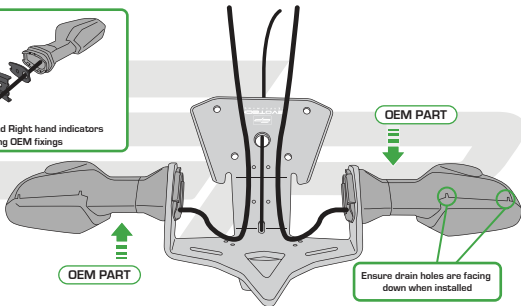
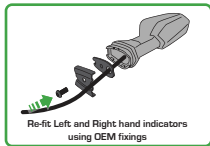

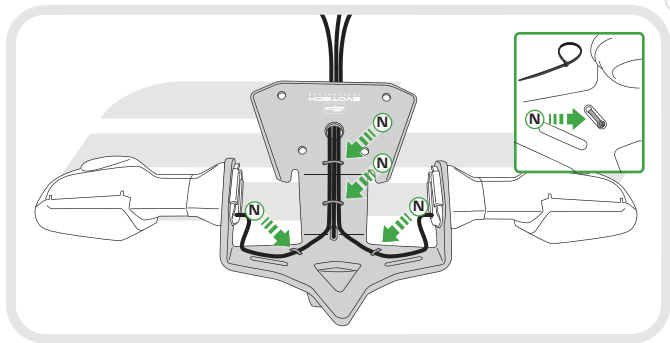

EVOTECH[®]
P E R F O R M A N C E

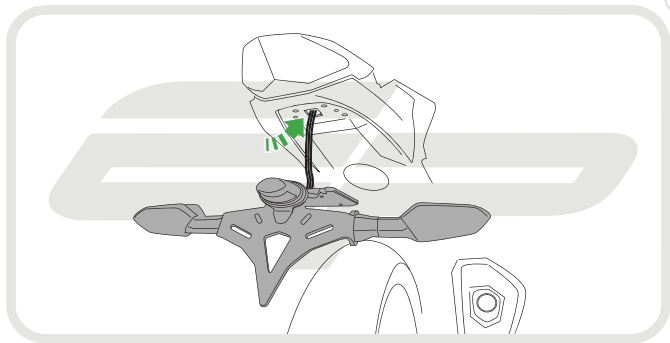

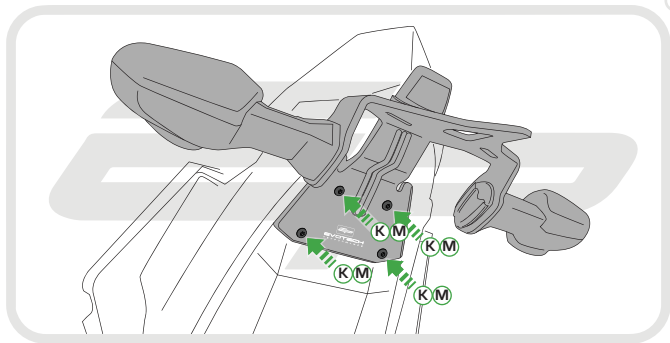

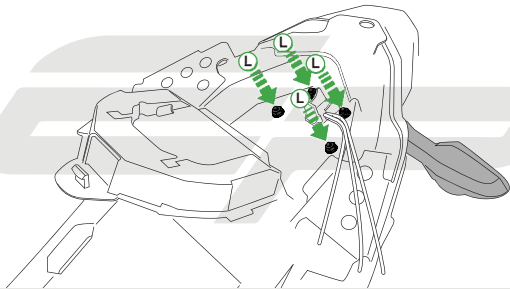

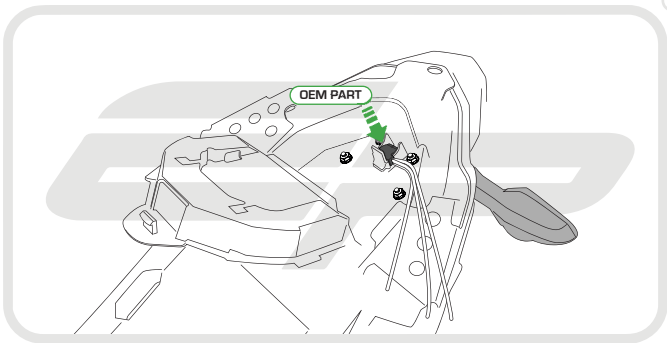

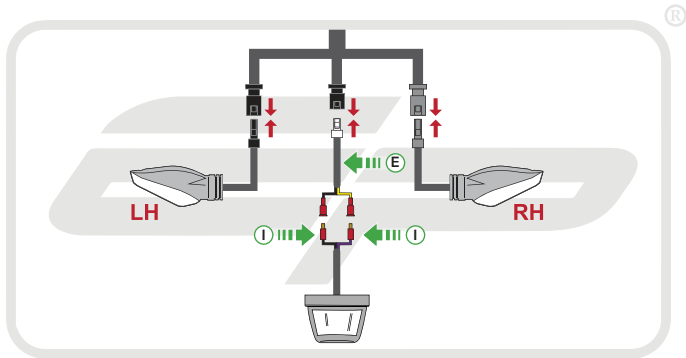



Reverse Stages

13 - 1

Reflector Bracket Installation

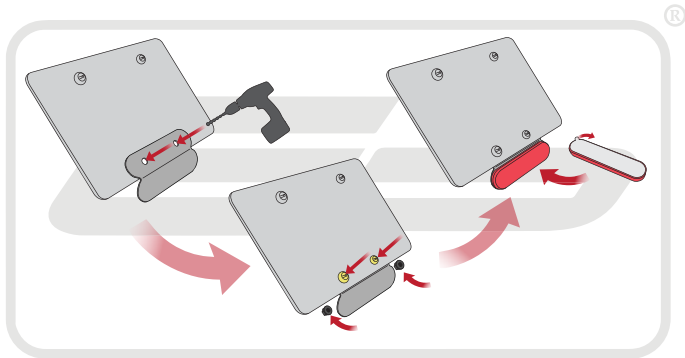

EVOTECH[®]
P E R F O R M A N C E



 **ESSENTIAL CHECKS** 

After installation of your tail tidy ensure that the licence plate does not contact the rear tyre when suspension is fully compressed.

Ensure all electrics including indicators, tail light, brake light and licence plate light lights are working correctly before riding the motorcycle.

It is recommended that periodic inspections are made to ensure that all fixings are fully tightend.



EVOTECH®
P E R F O R M A N C E

www.evotech-performance.com