

**EVOTECH**®  
P E R F O R M A N C E

[www.evotech-performance.com](http://www.evotech-performance.com)

Aprilia RSV4 Radiator Guard Set

Installation Instructions



## Kit Contents PRN08163-008164

- (A) 1 x Radiator Guard
- (B) 1 x Oil Cooler Guard
- (C) 2 x Mounting Brackets
- (D) 2 x Zip Ties
- (E) 2 x M6 - 16 Socket Button Head Screw
- (F) 2 x M6 - 25 Socket Button Head Screw
- (G) 2 x M6 Washers
- (H) 2 x M6 Special Washers
- (I) 4 x M4 - 10 Socket Button Head Screws
- (J) 4 x 5mm Neoprene
- (K) 6 x 3mm Neoprene

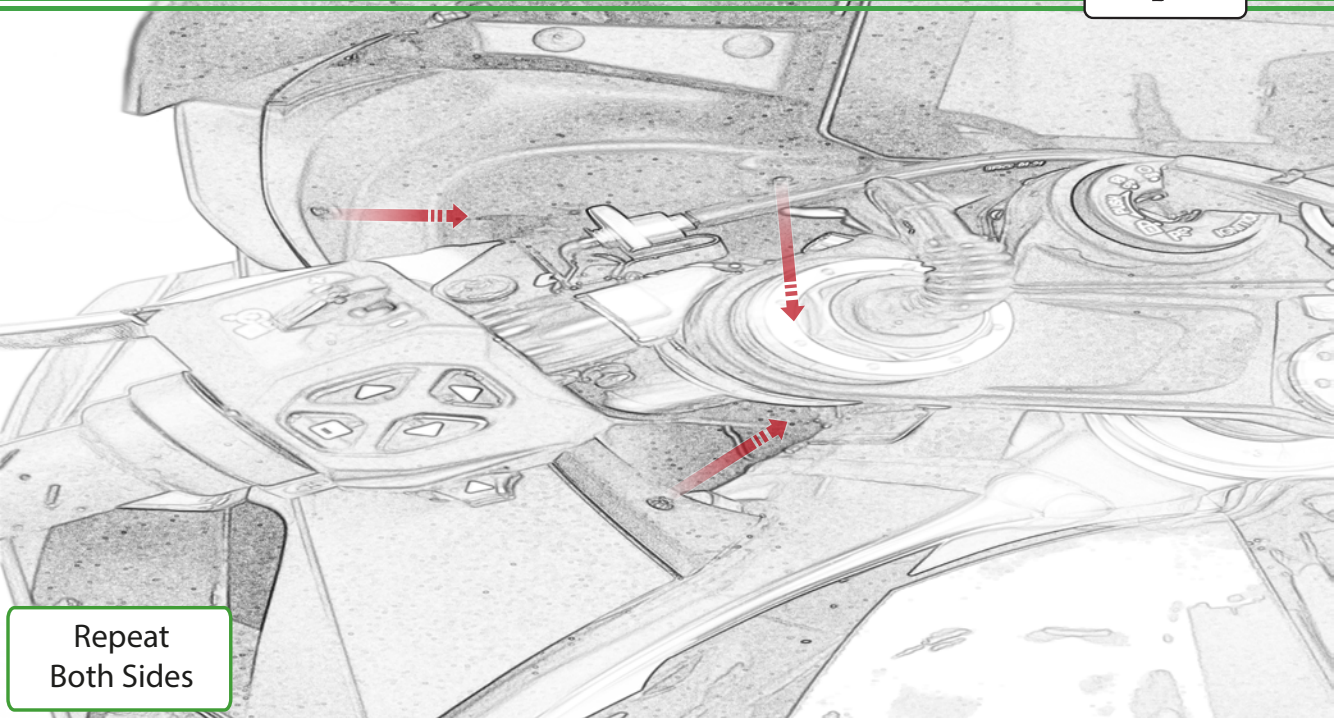

Repeat  
Both Sides

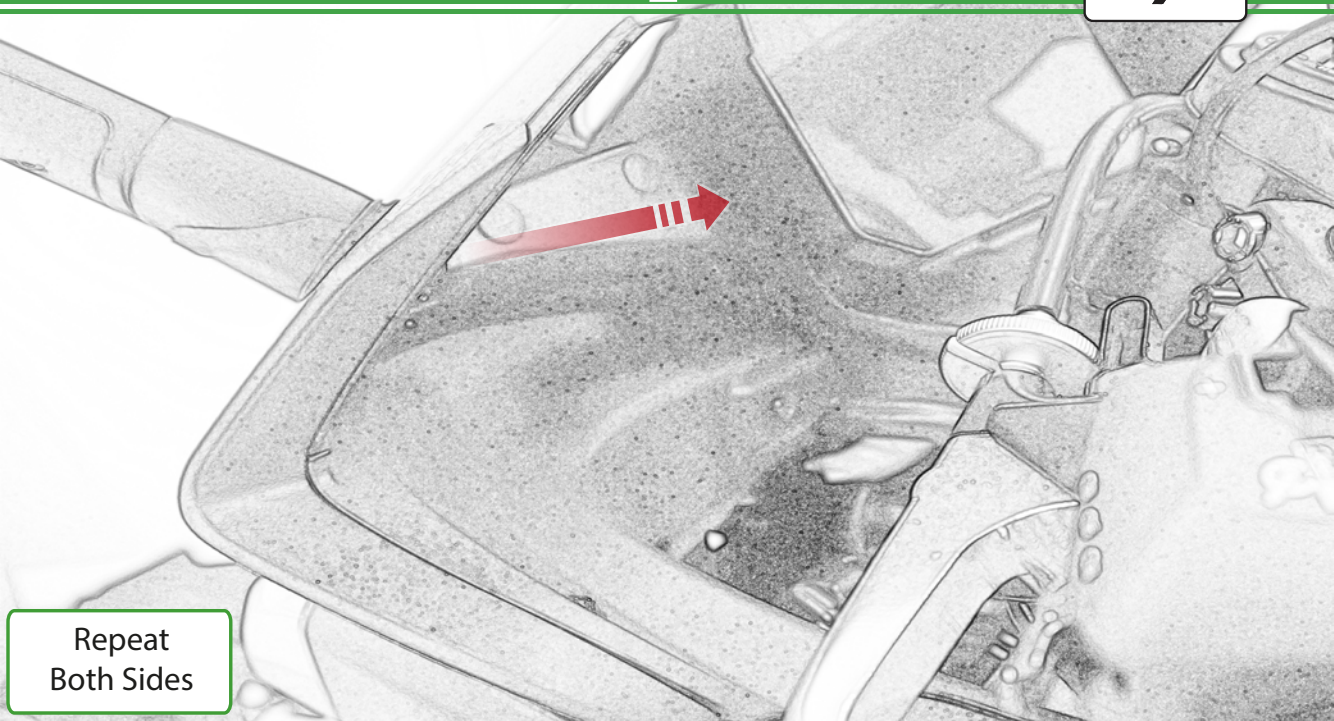

Repeat  
Both Sides

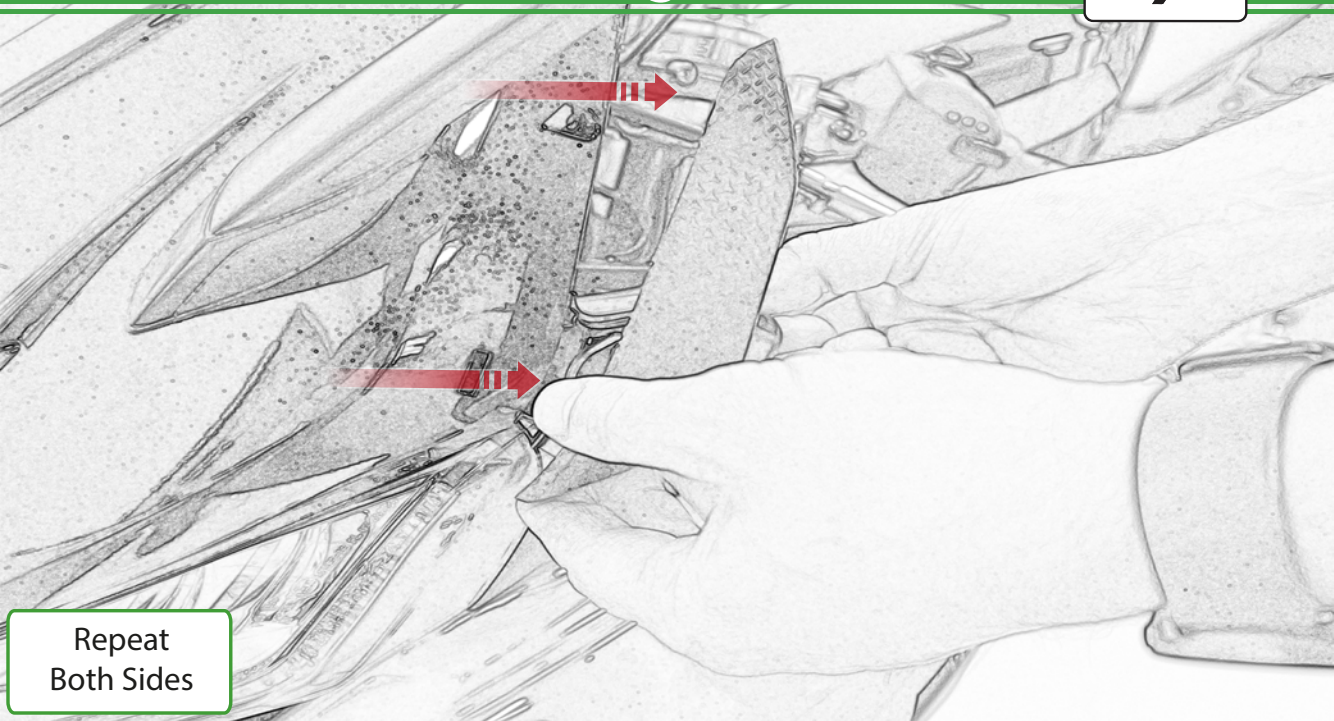

Repeat  
Both Sides

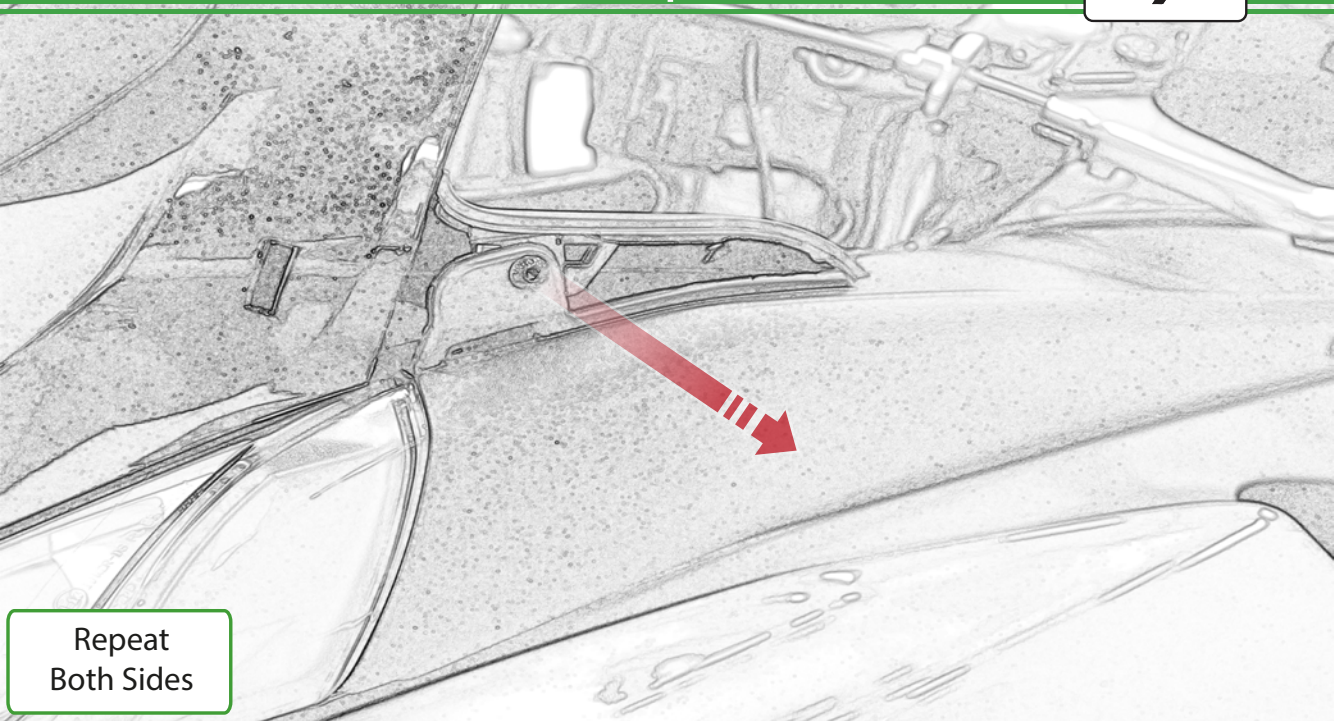

Repeat  
Both Sides

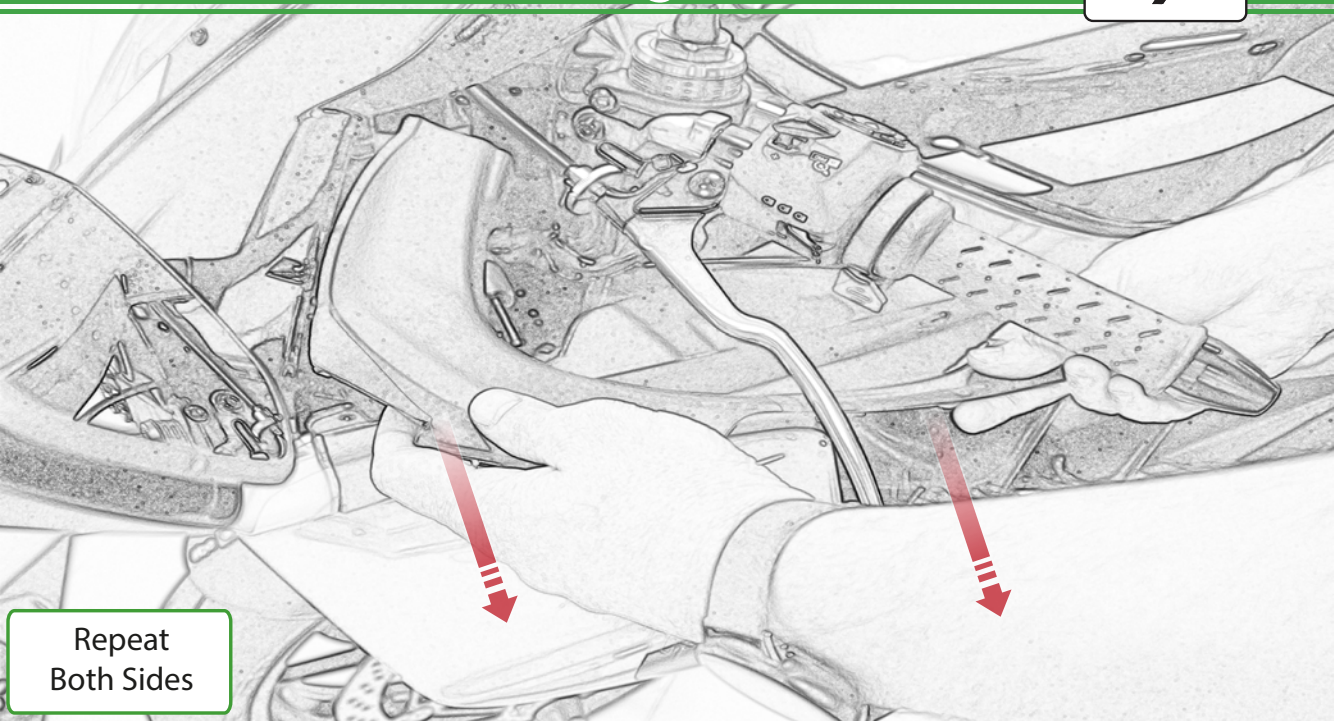

Repeat  
Both Sides

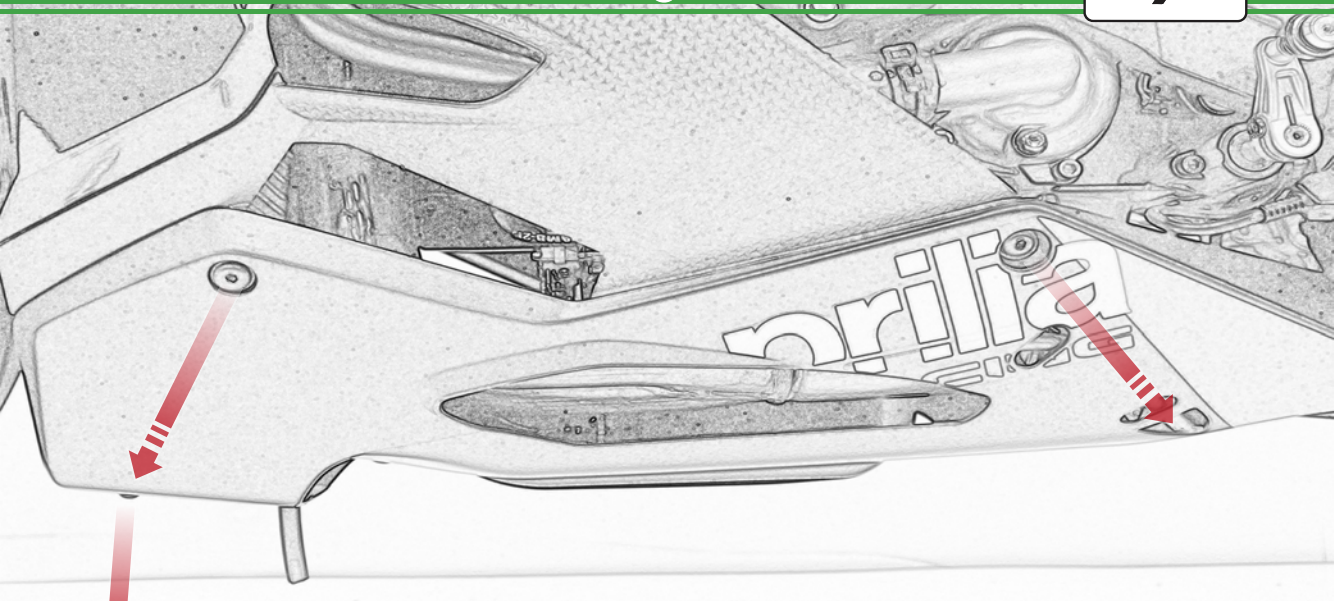

Repeat  
Both Sides



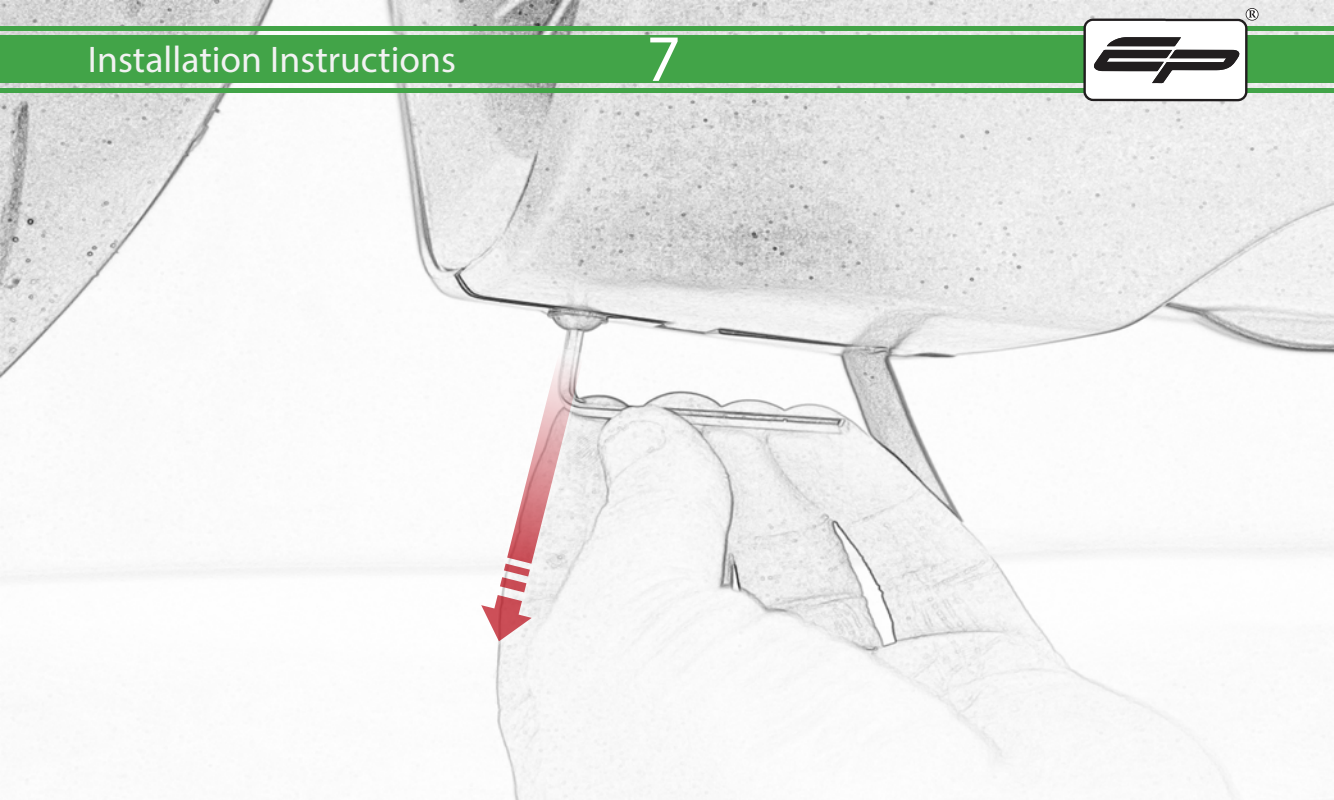

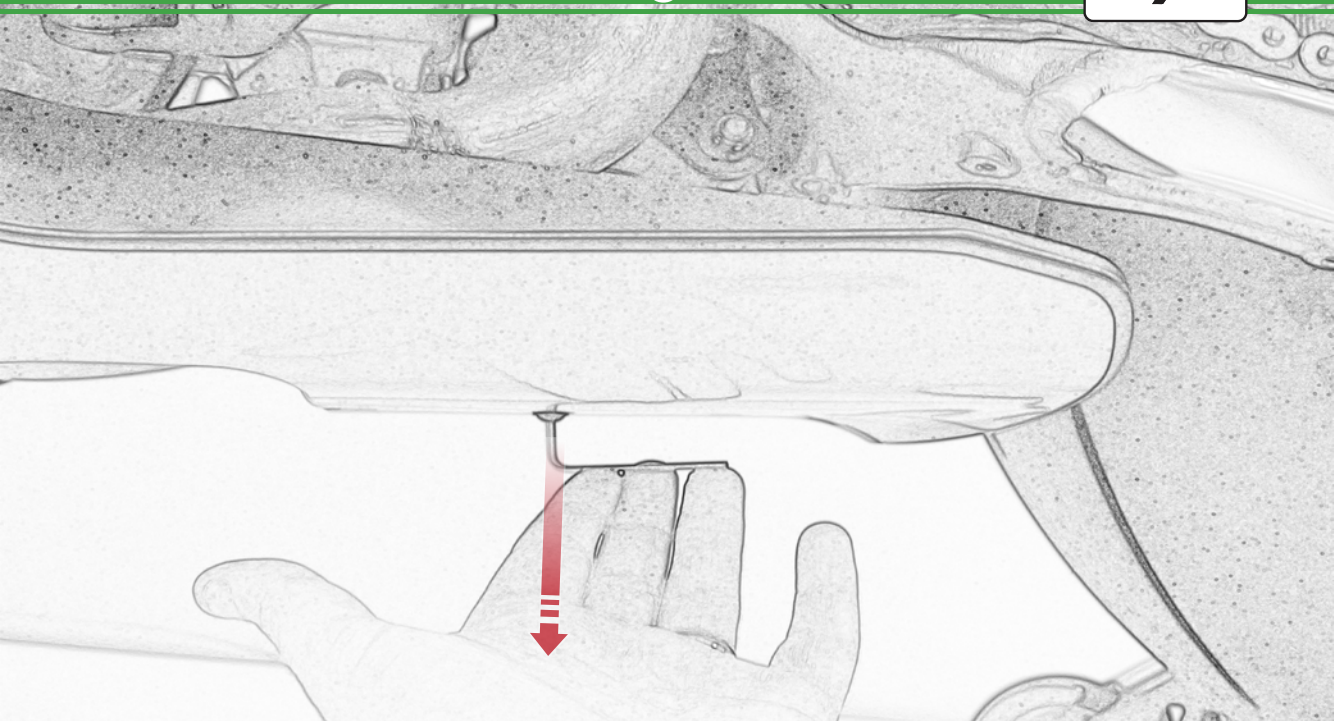

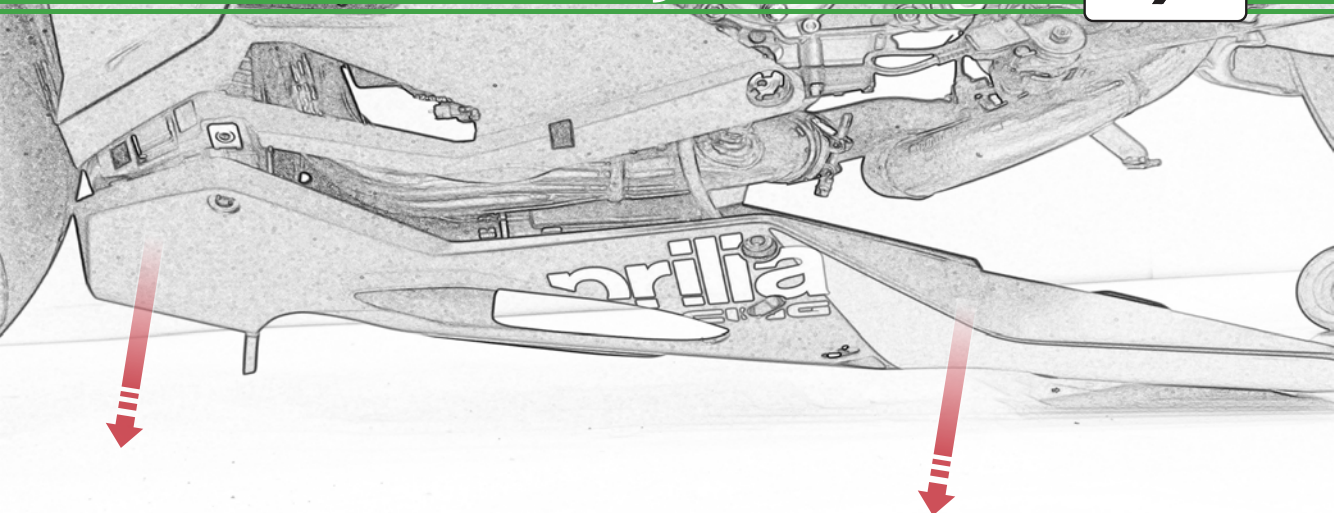

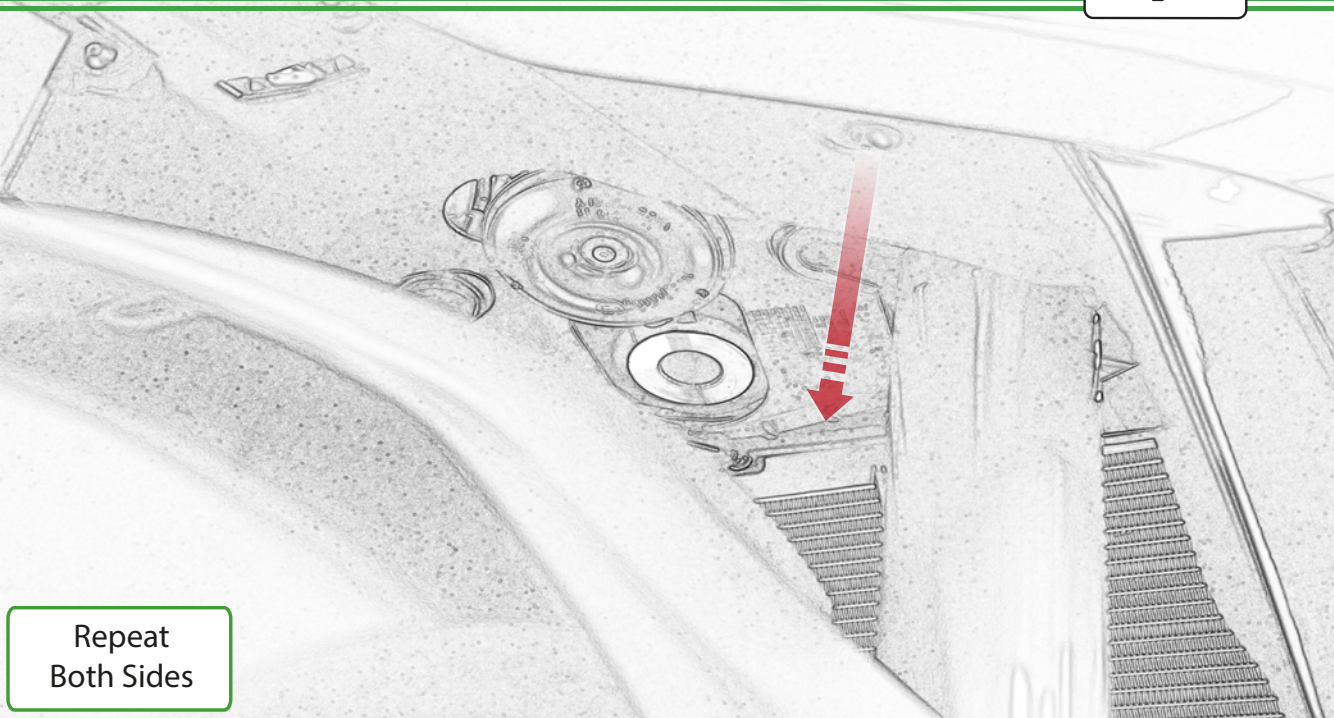

Repeat  
Both Sides

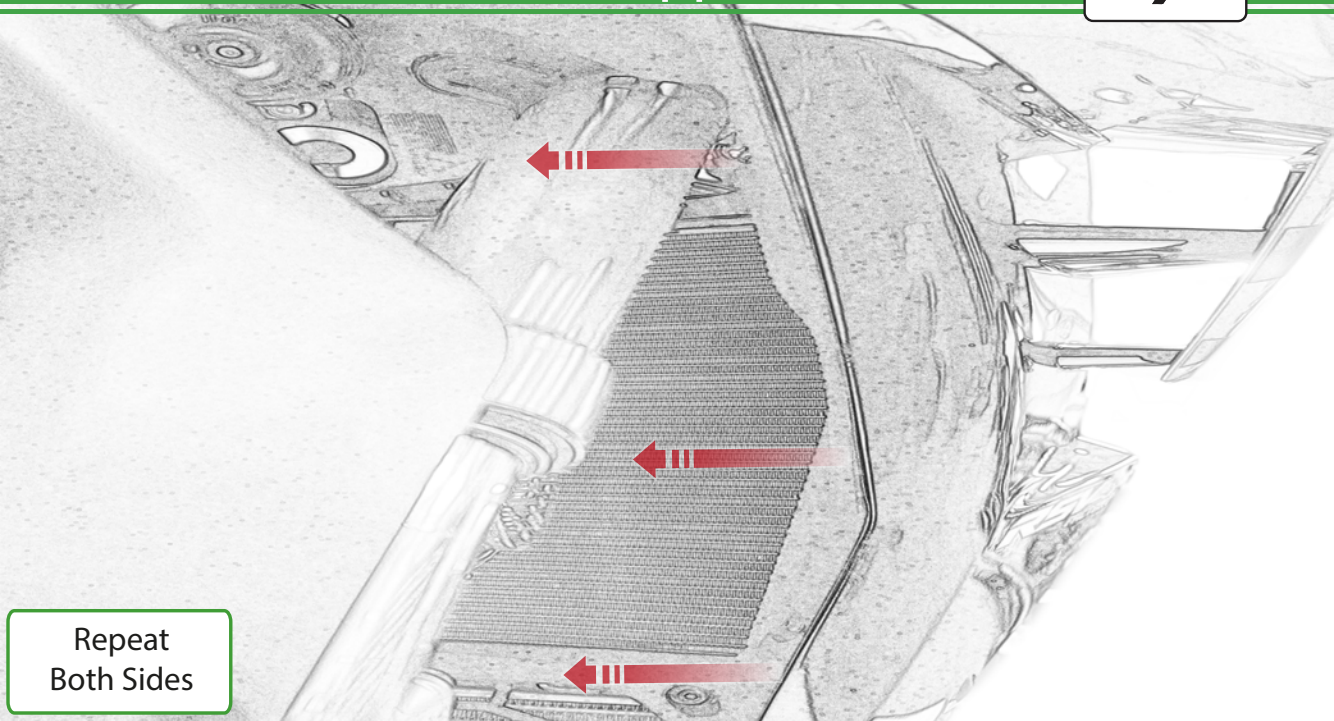

Repeat  
Both Sides

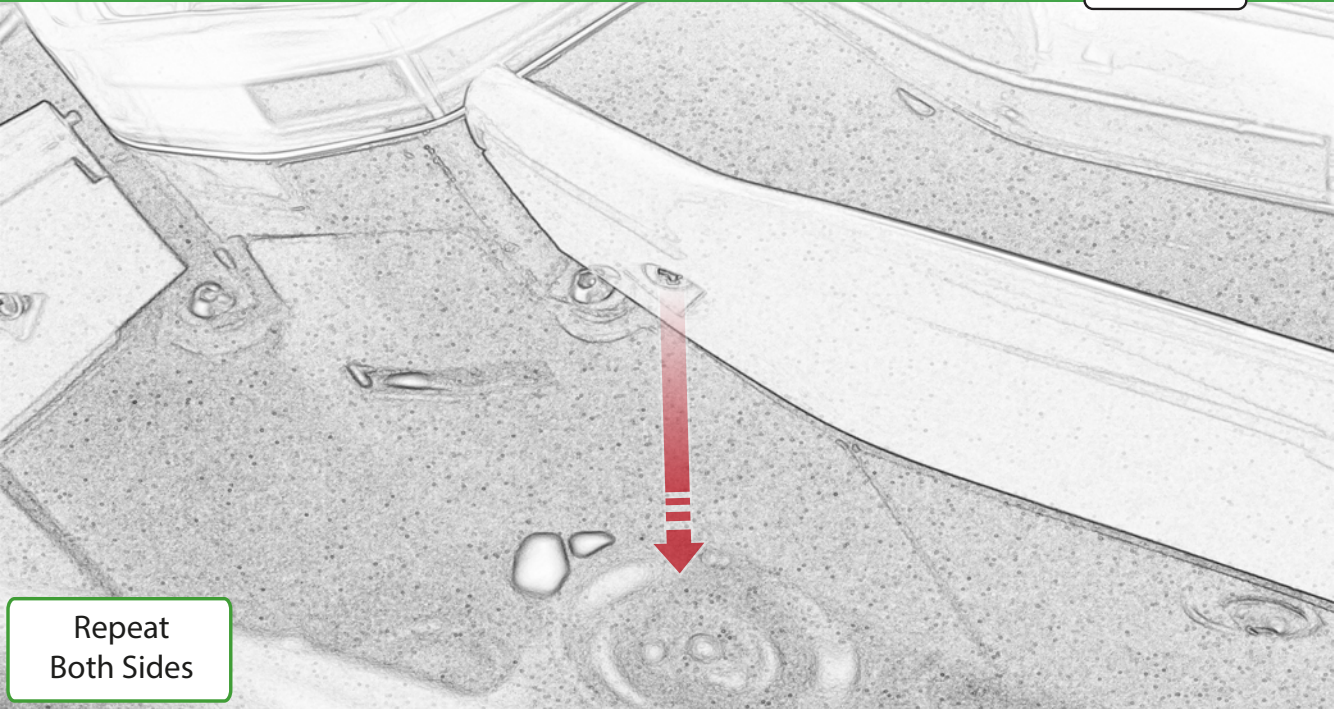

Repeat  
Both Sides

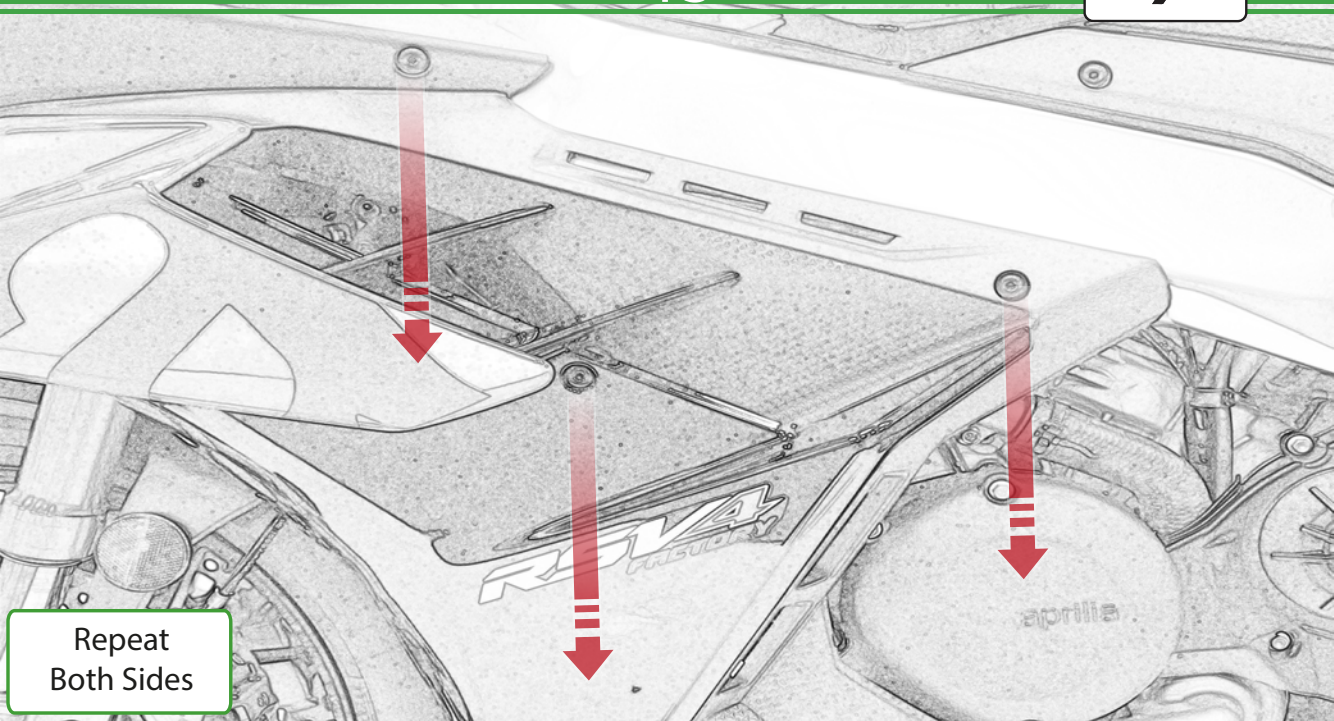

Repeat  
Both Sides

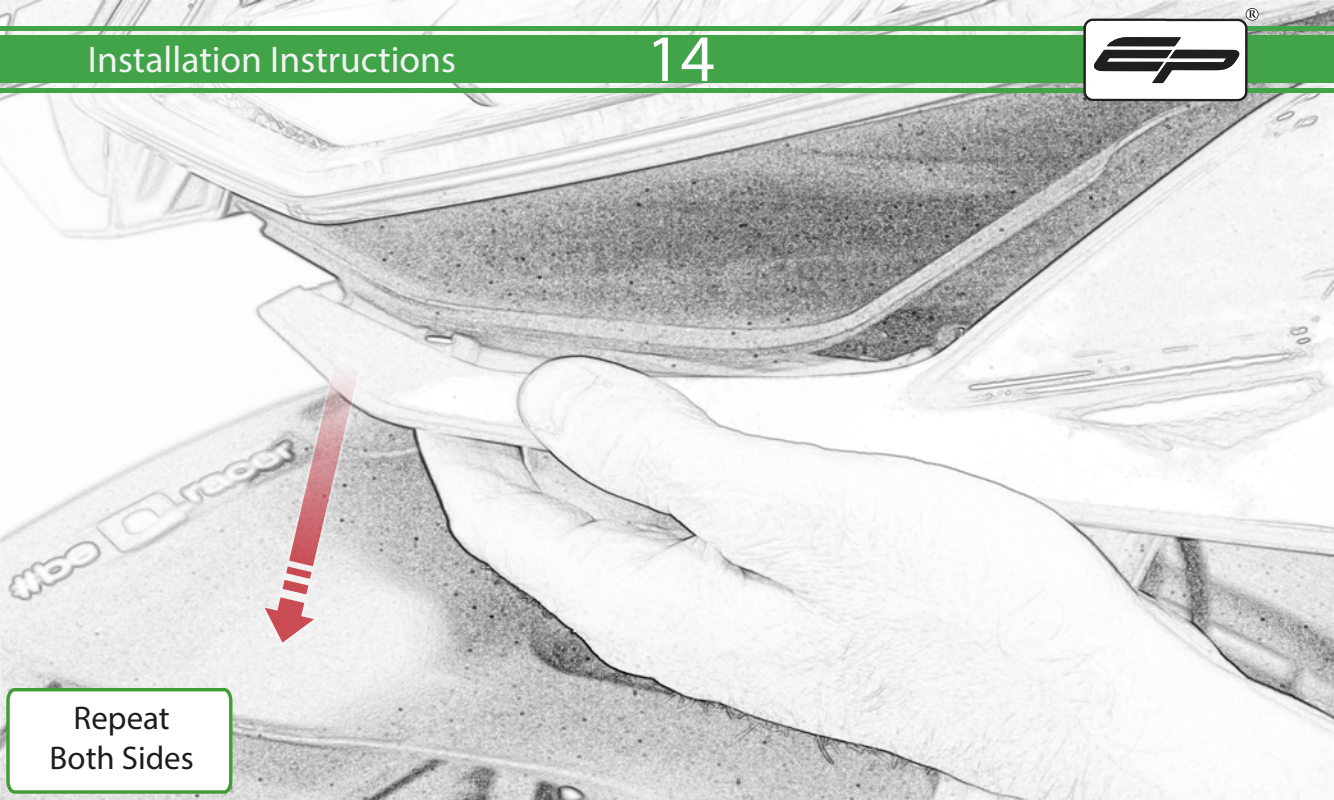

Repeat  
Both Sides



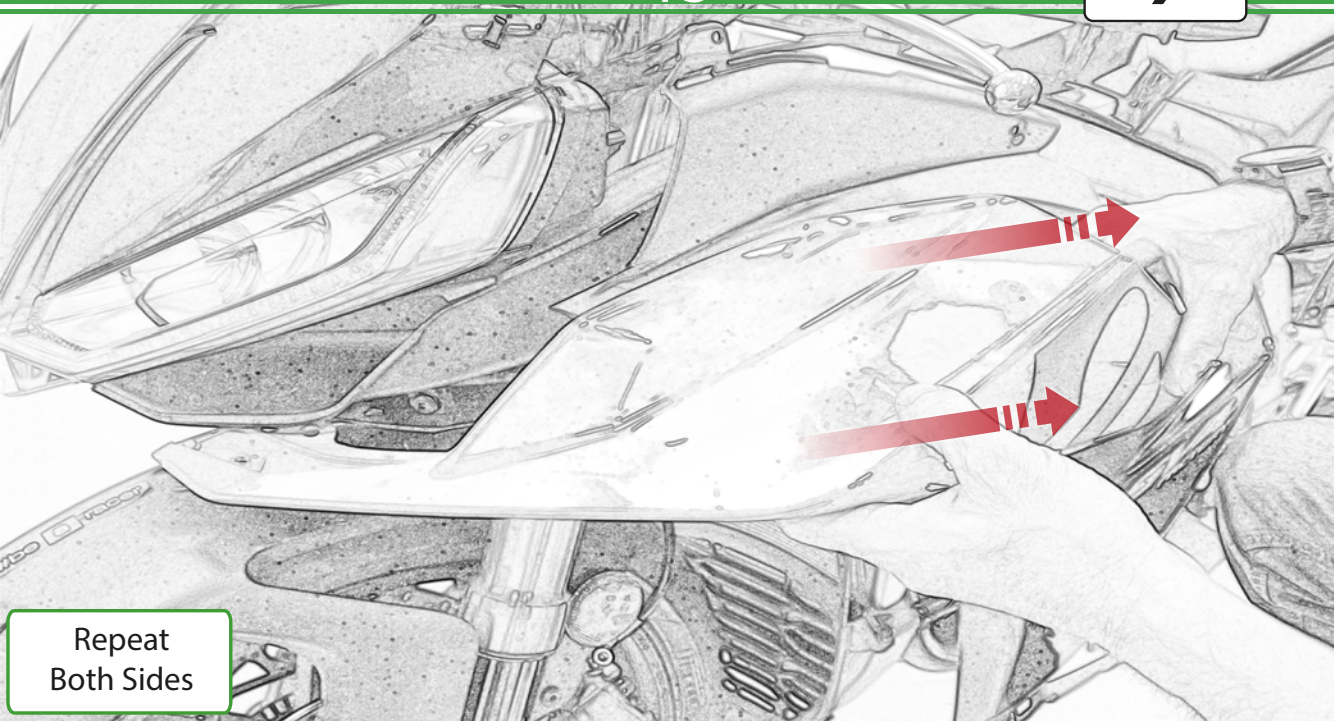

Repeat  
Both Sides

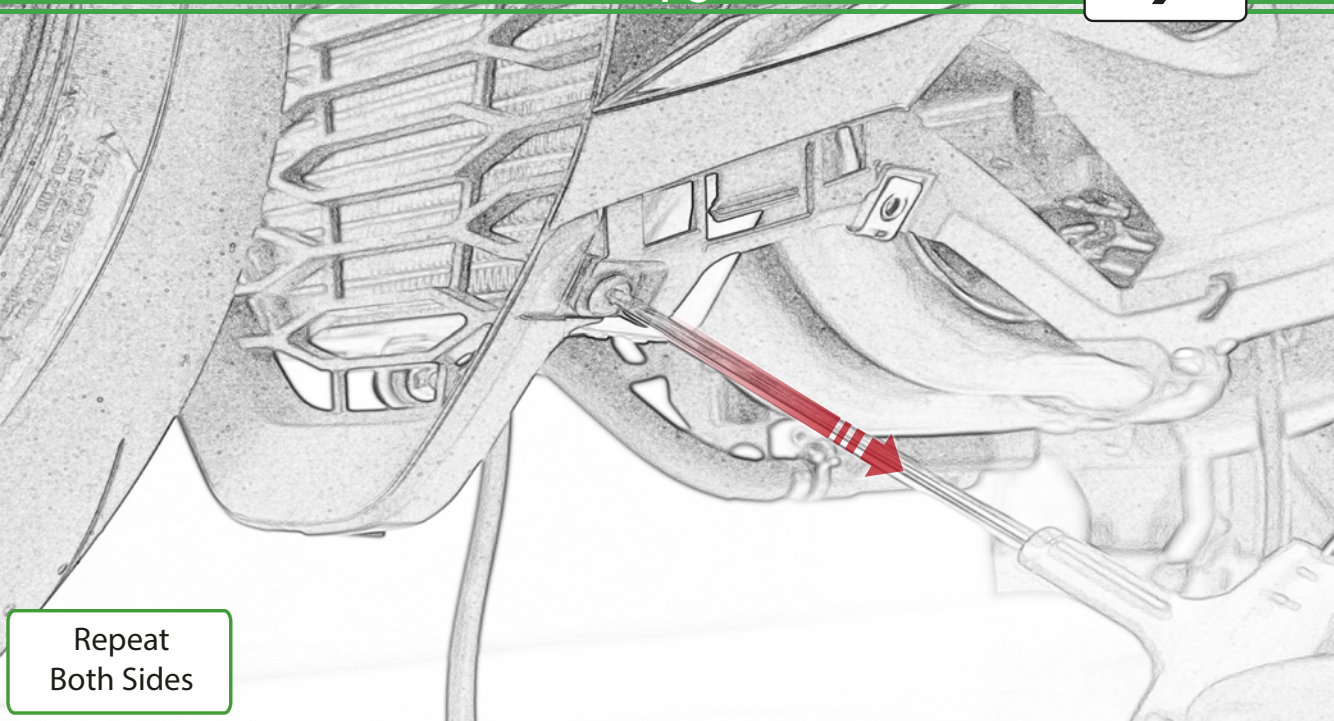

Repeat  
Both Sides

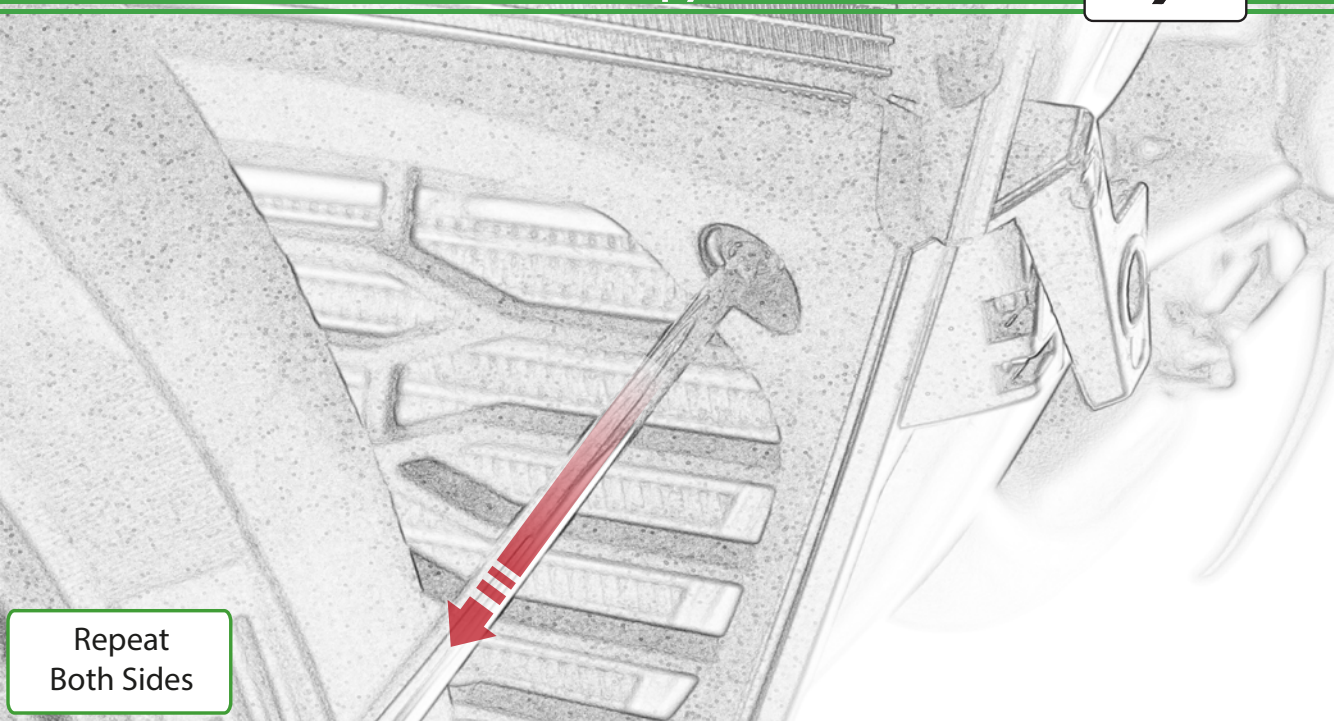

Repeat  
Both Sides

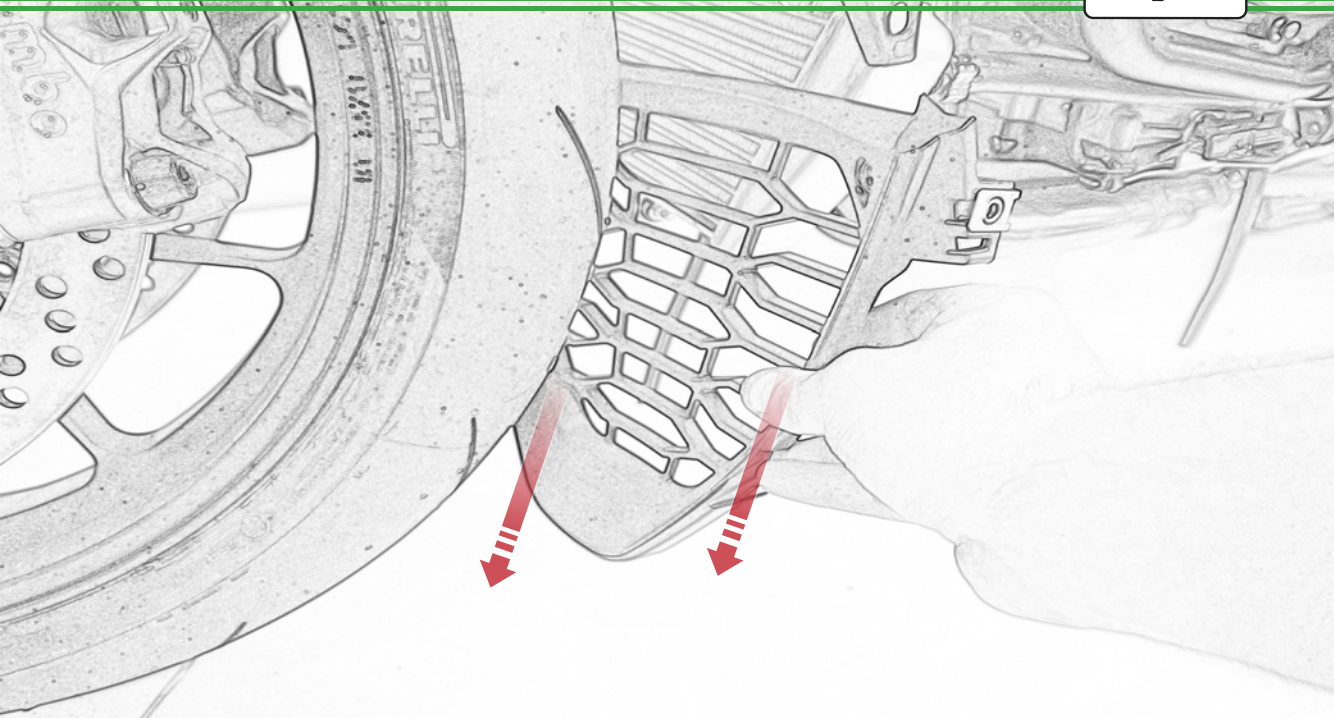

Repeat  
Both Sides

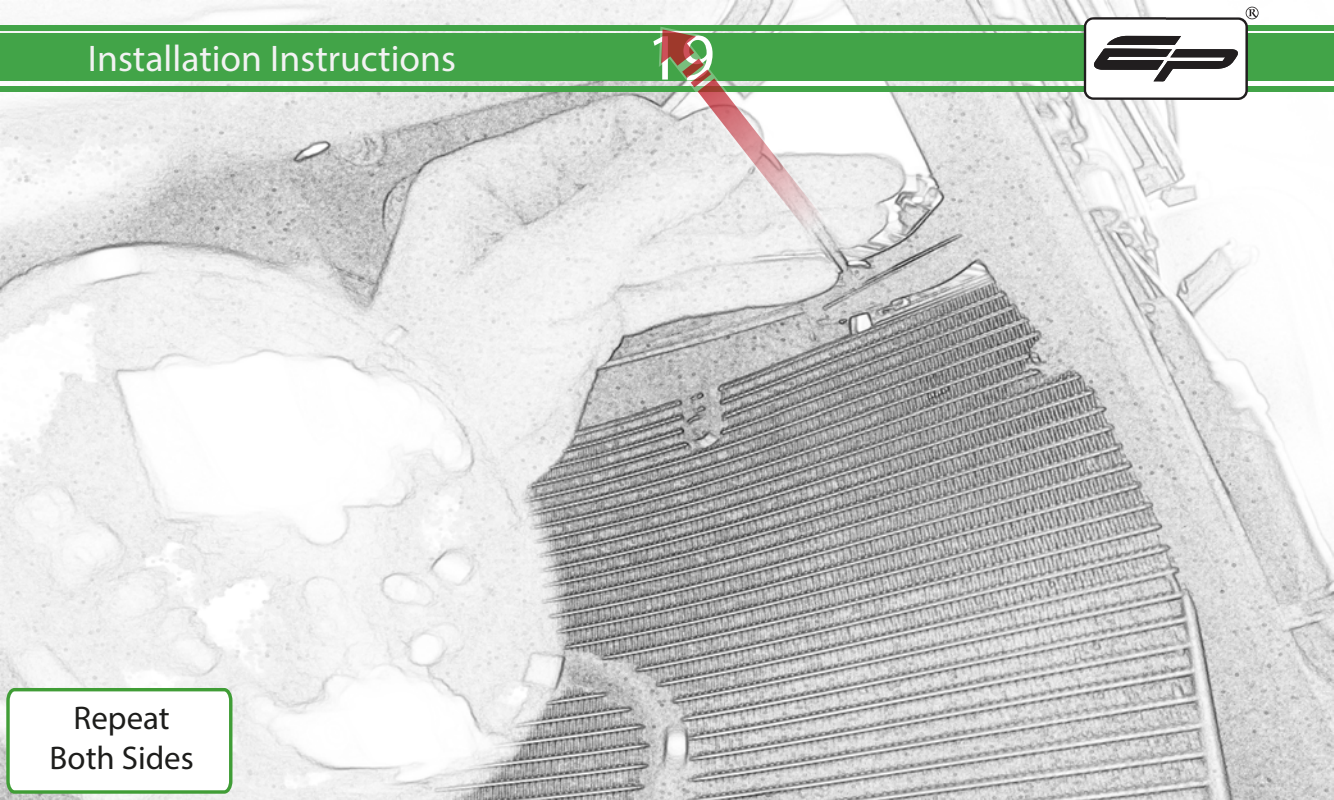

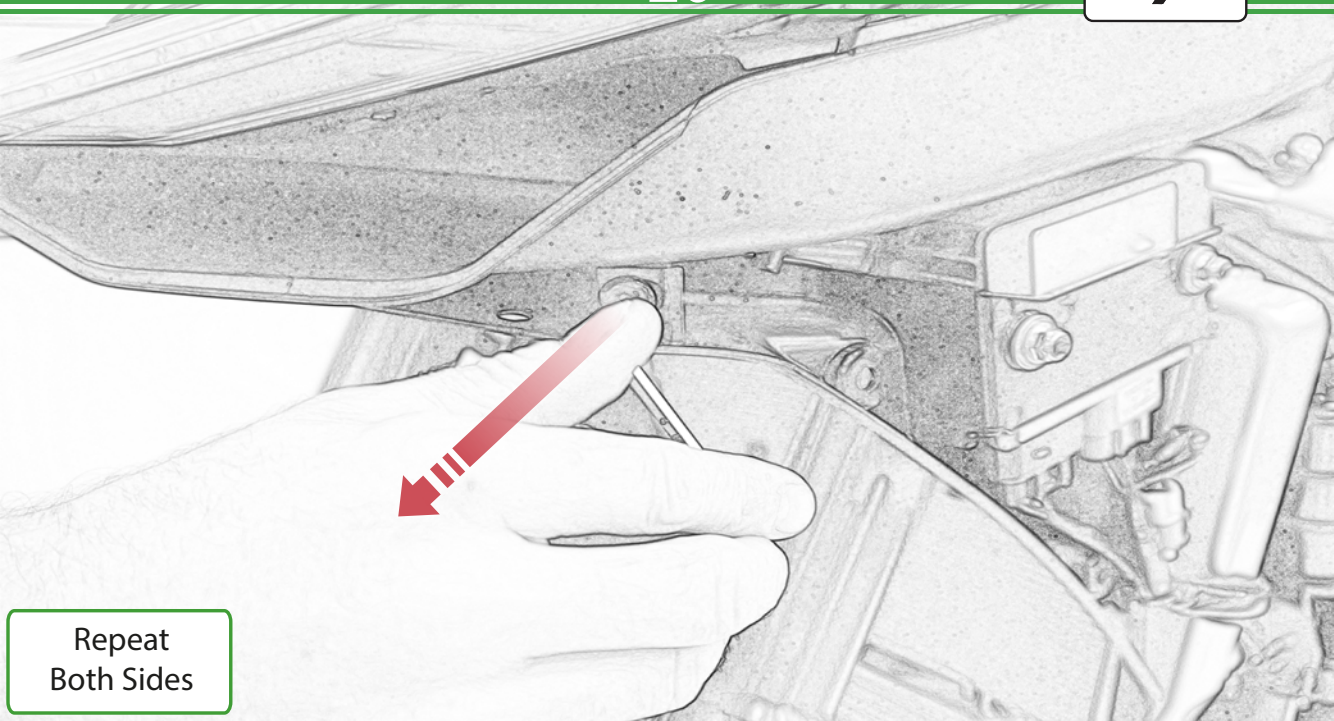

Repeat  
Both Sides

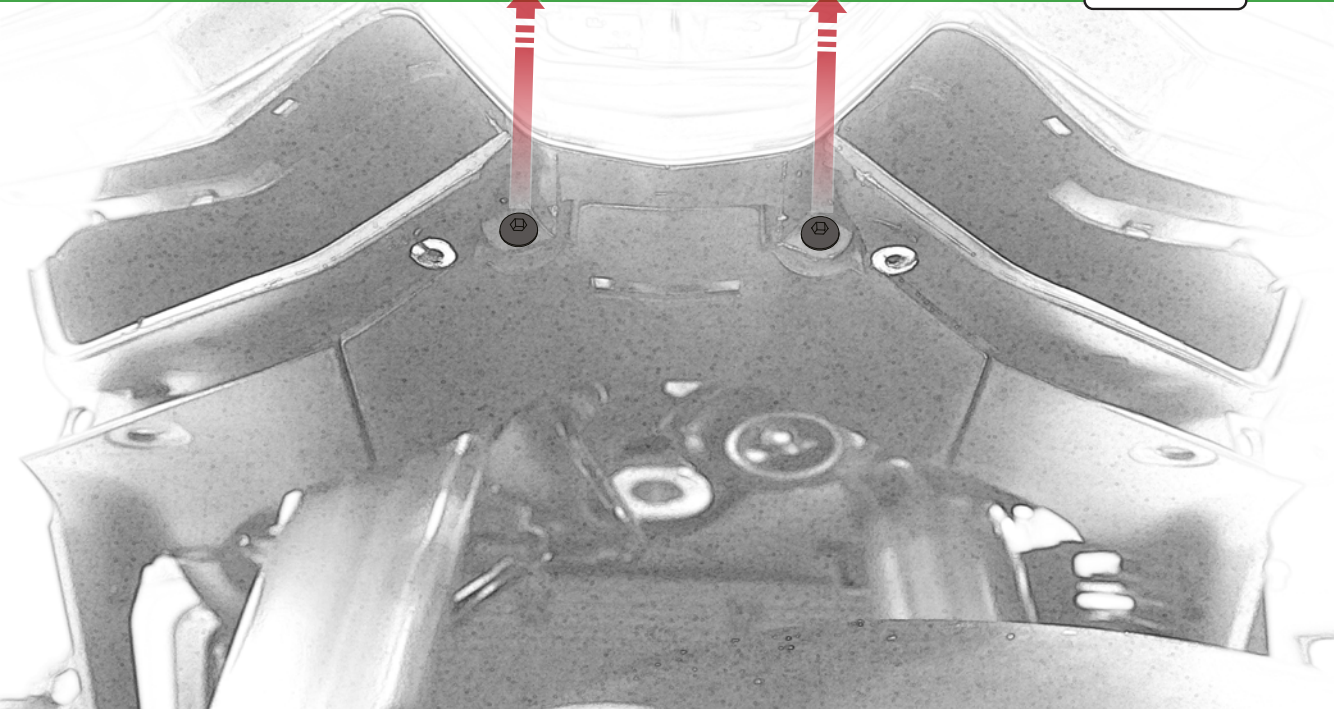

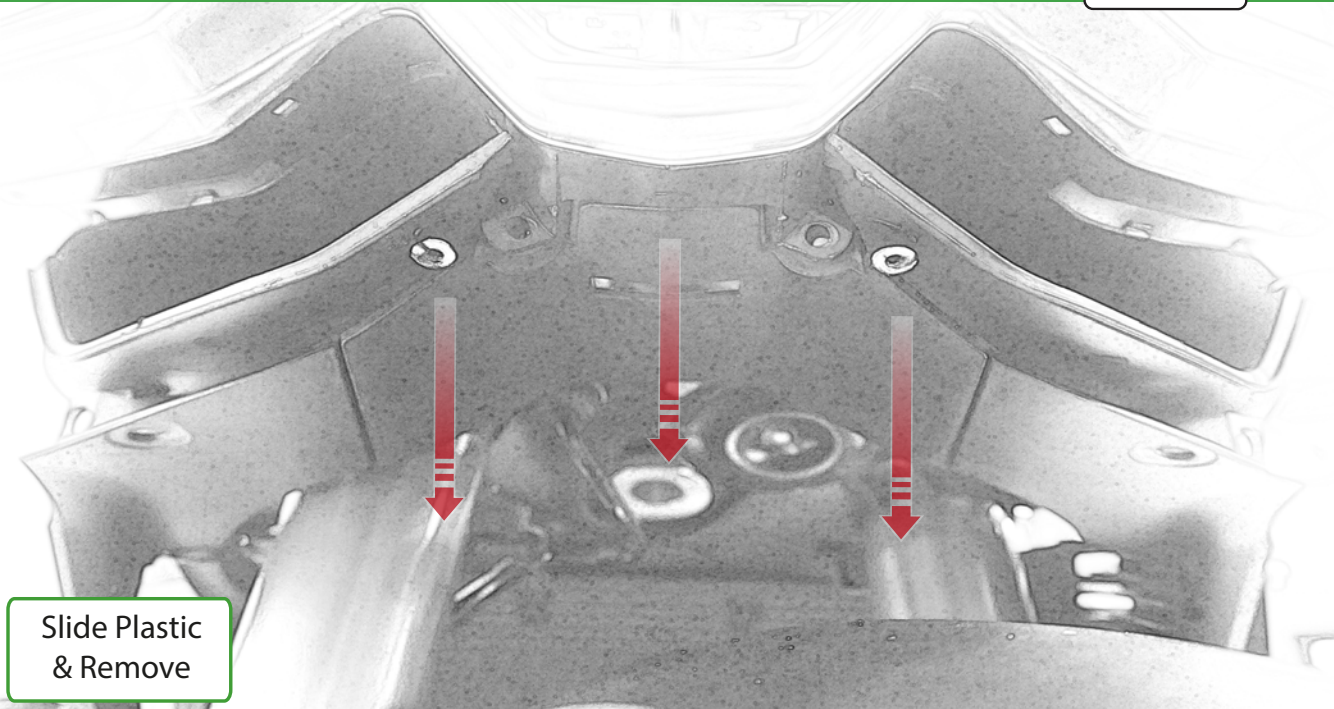

Slide Plastic  
& Remove



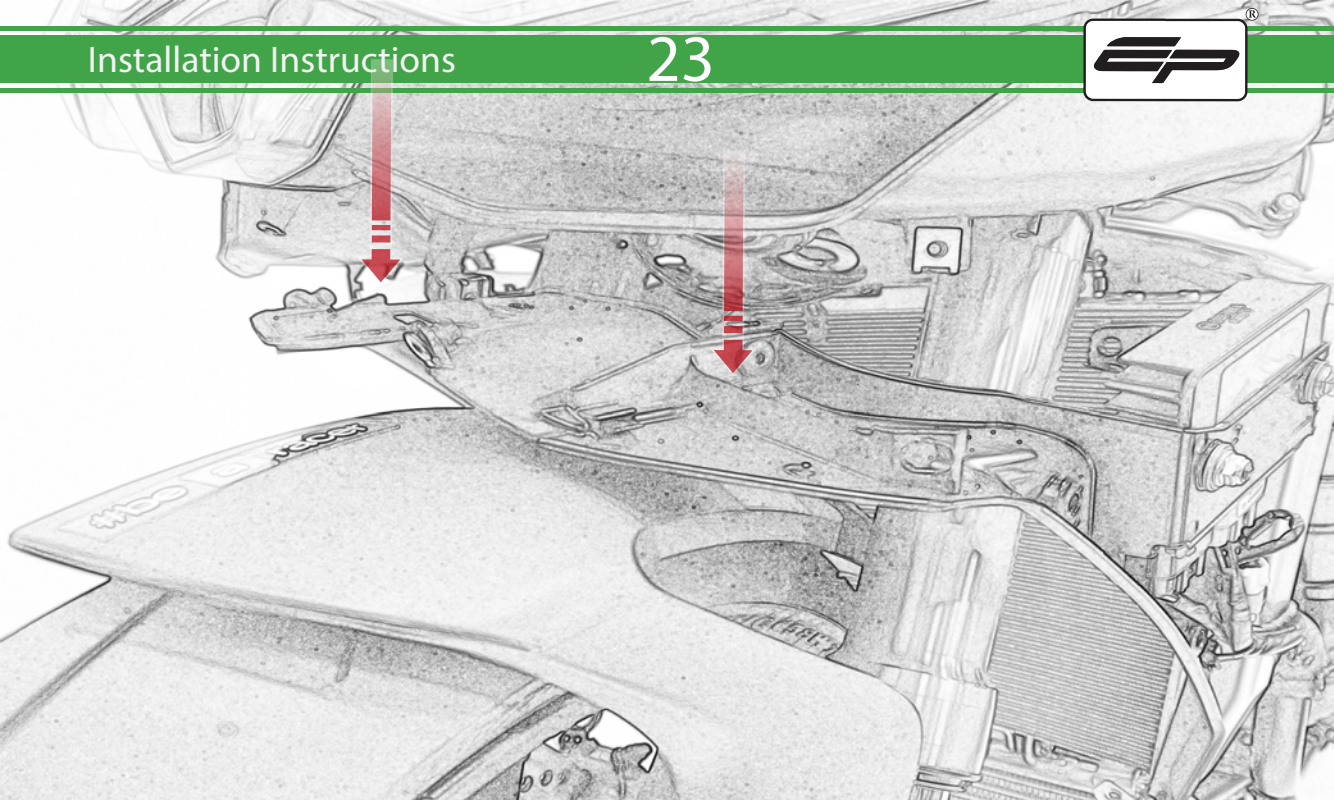

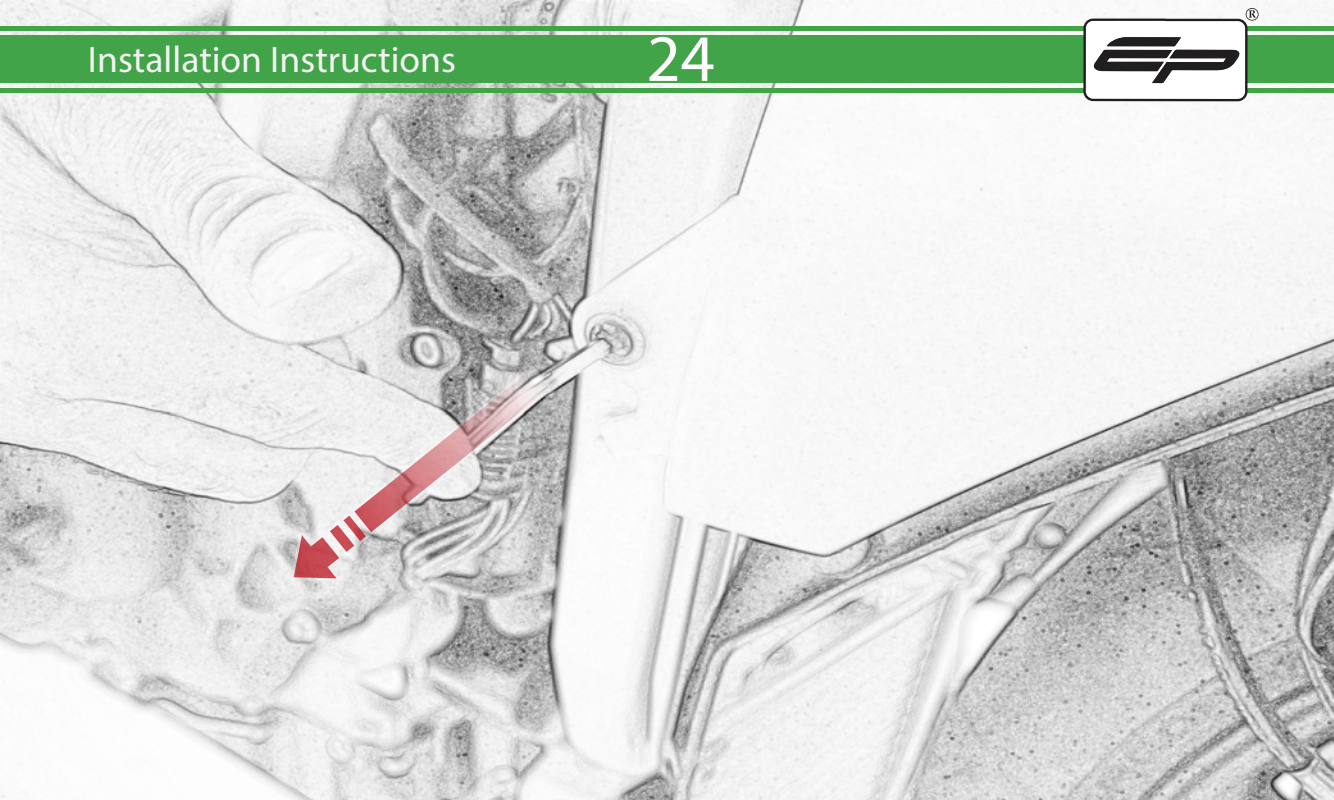

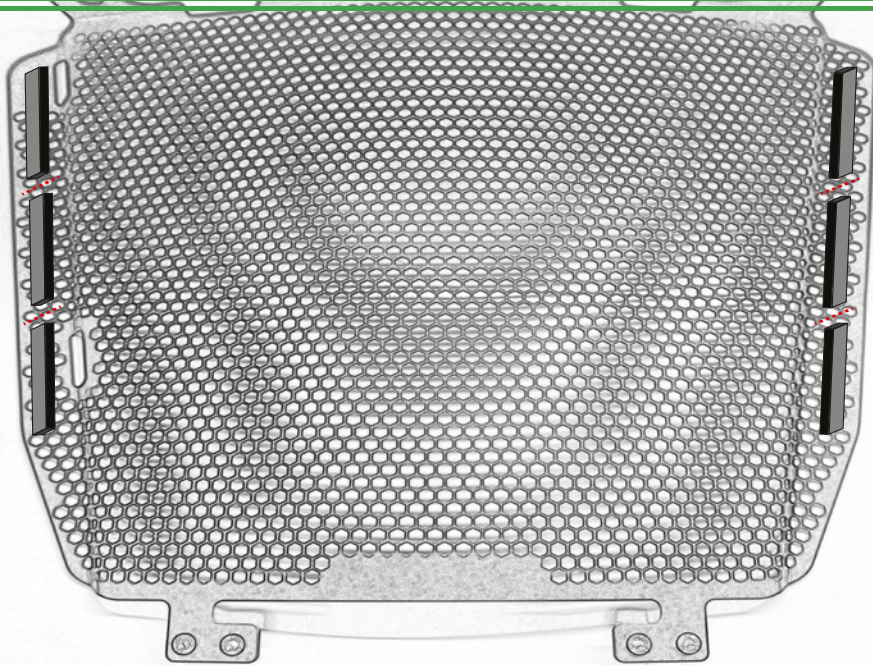

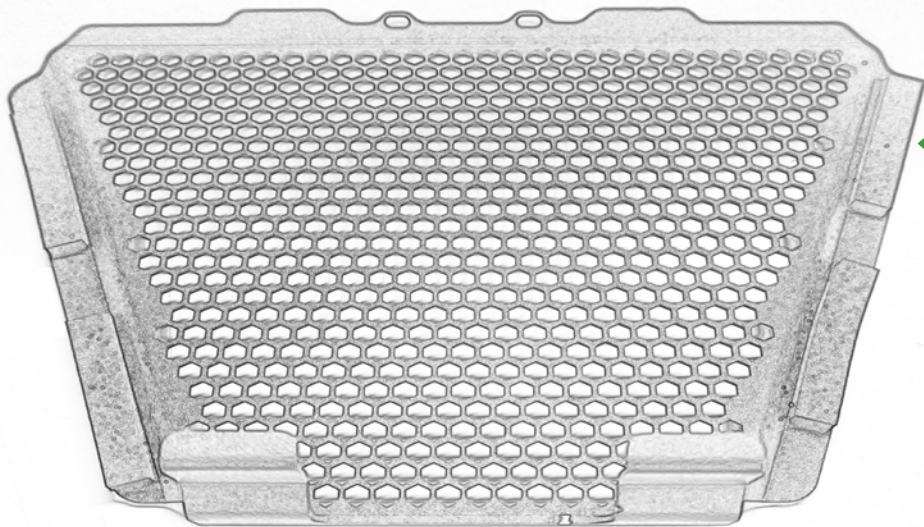

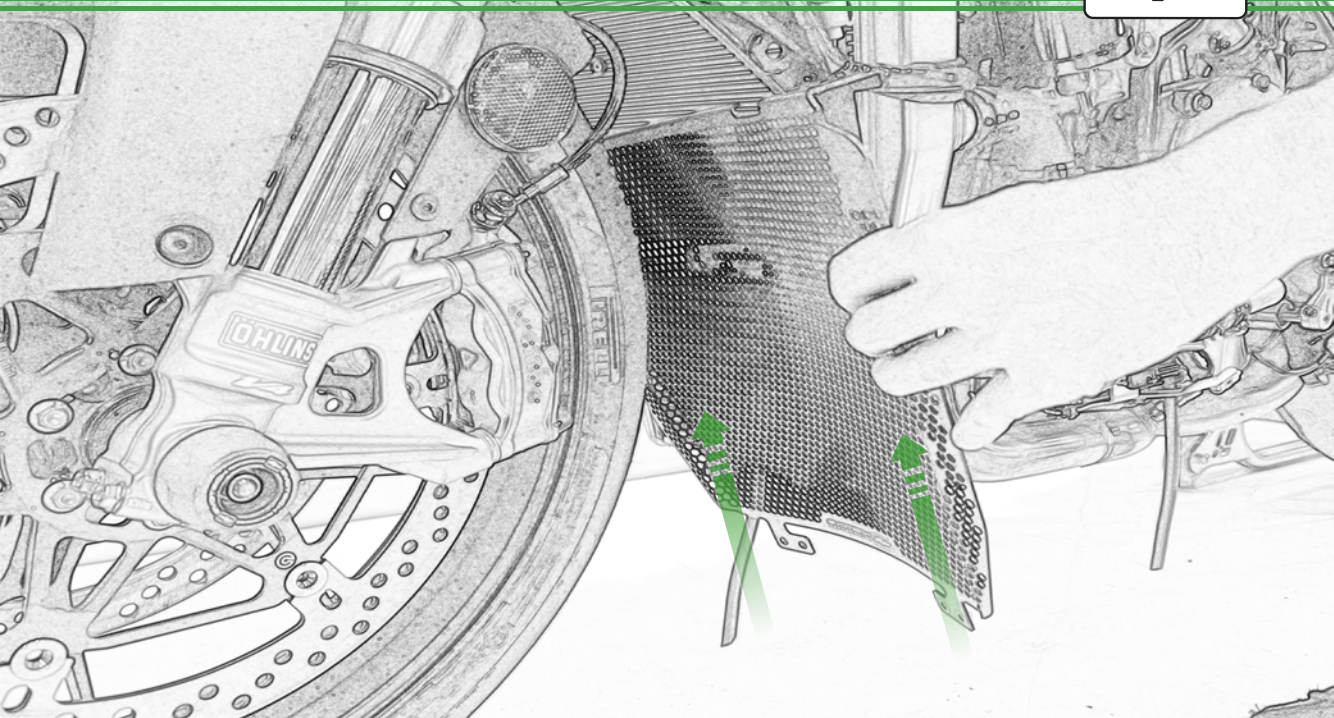

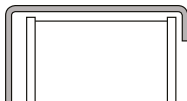
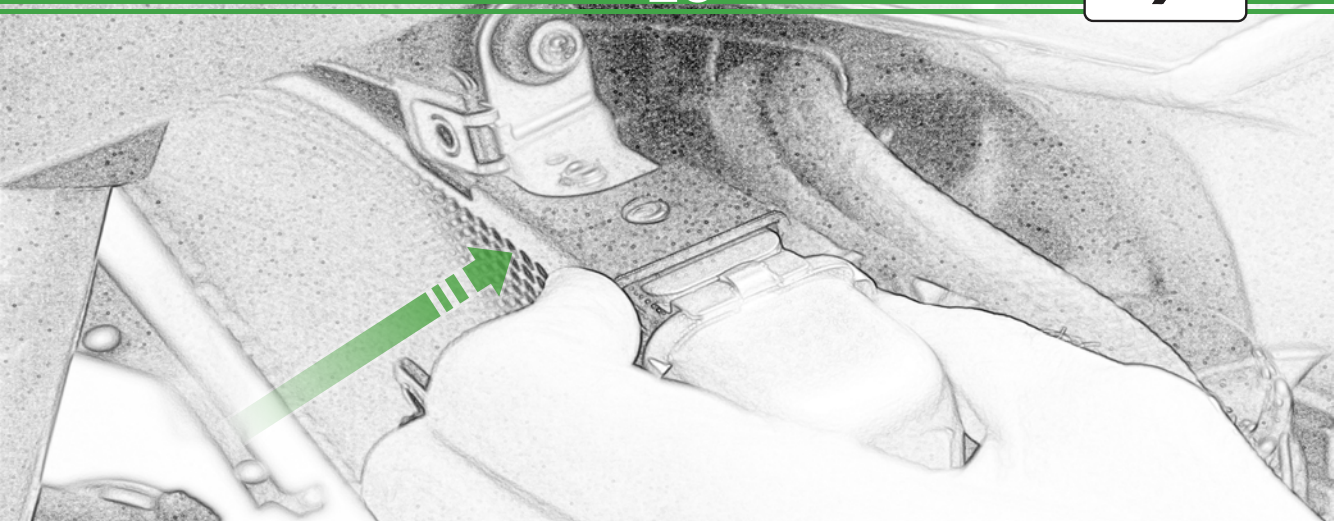

Ensure the radiator guard securely hooks over the top lip of the radiator



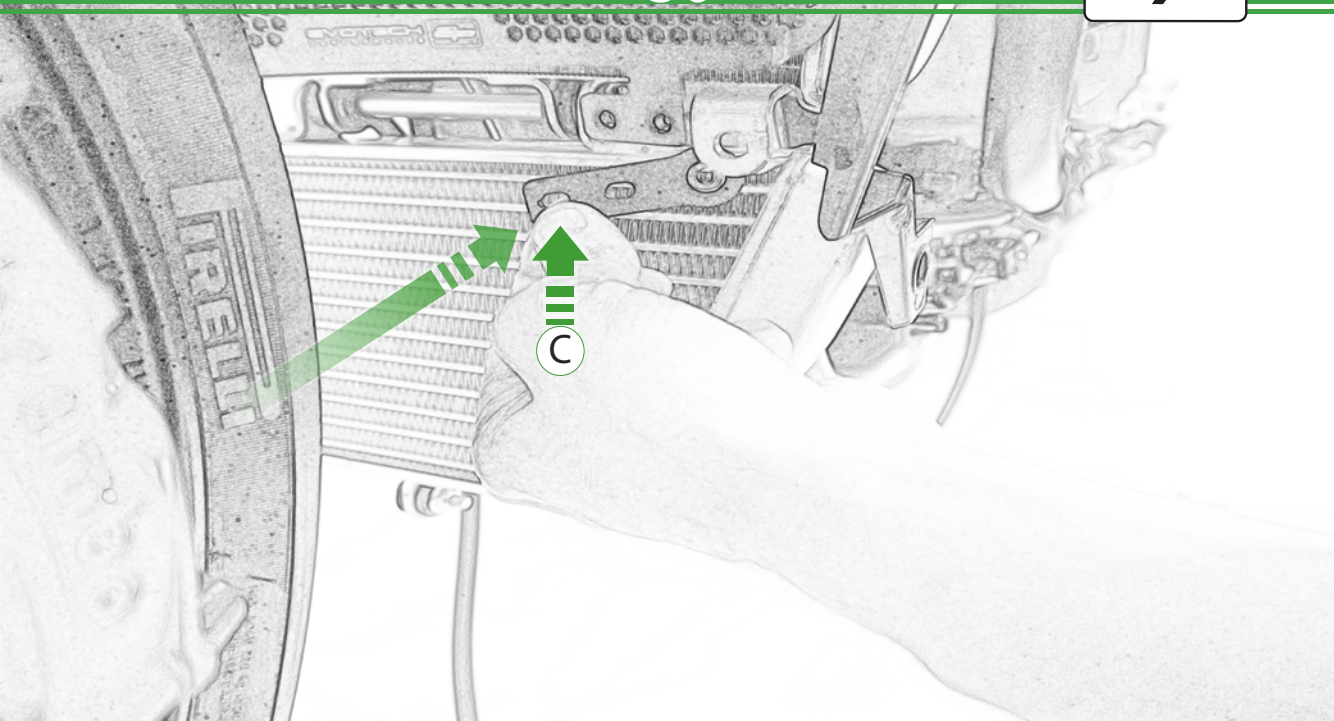



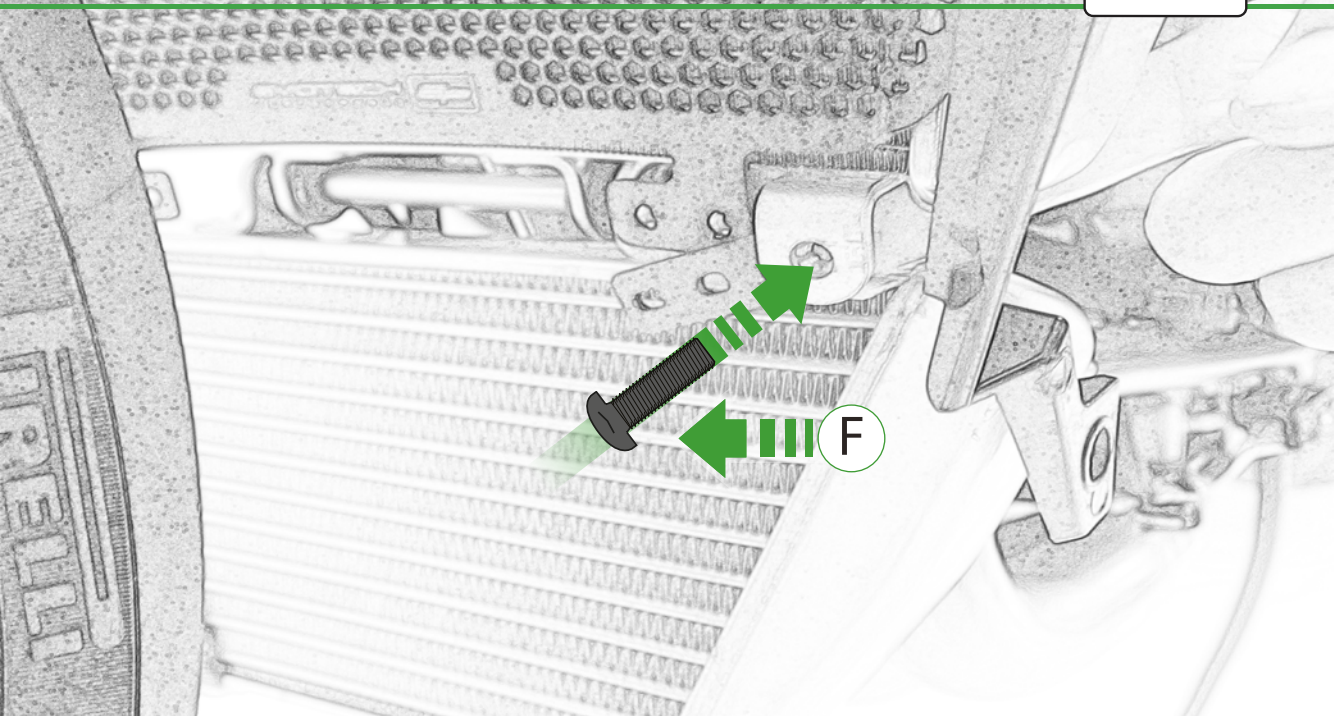

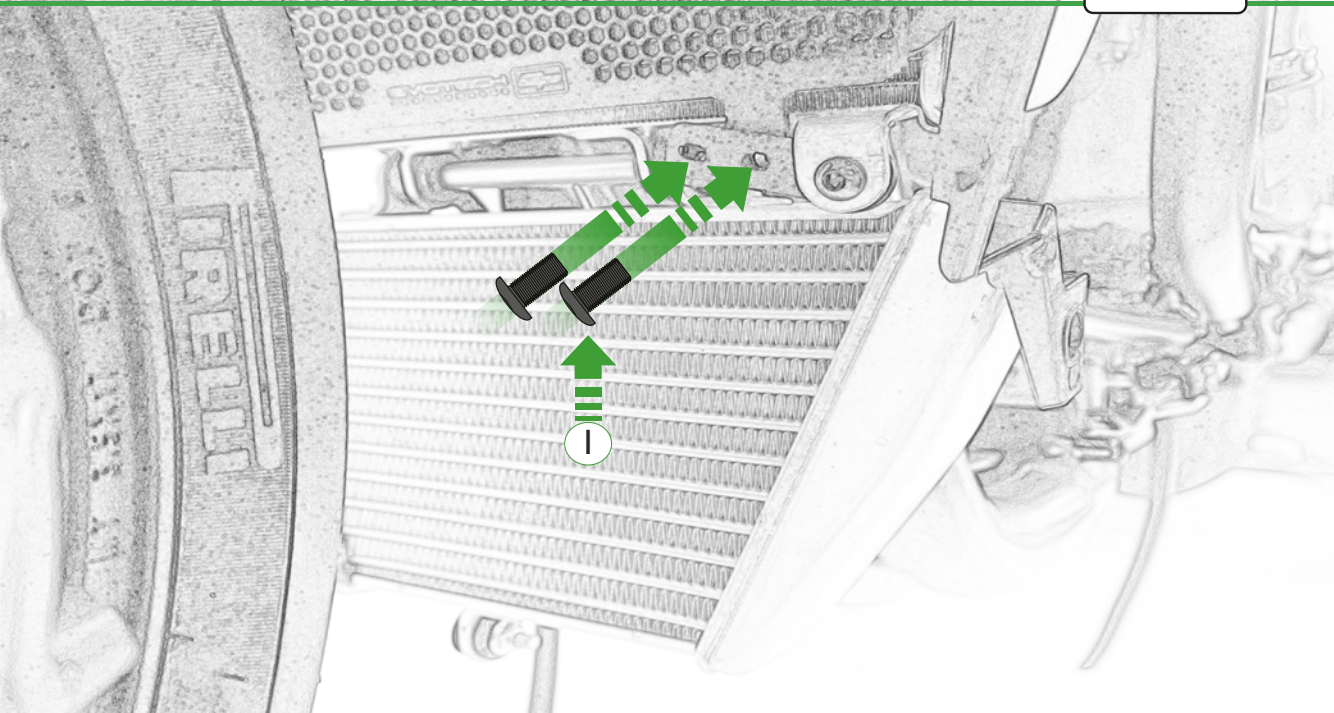

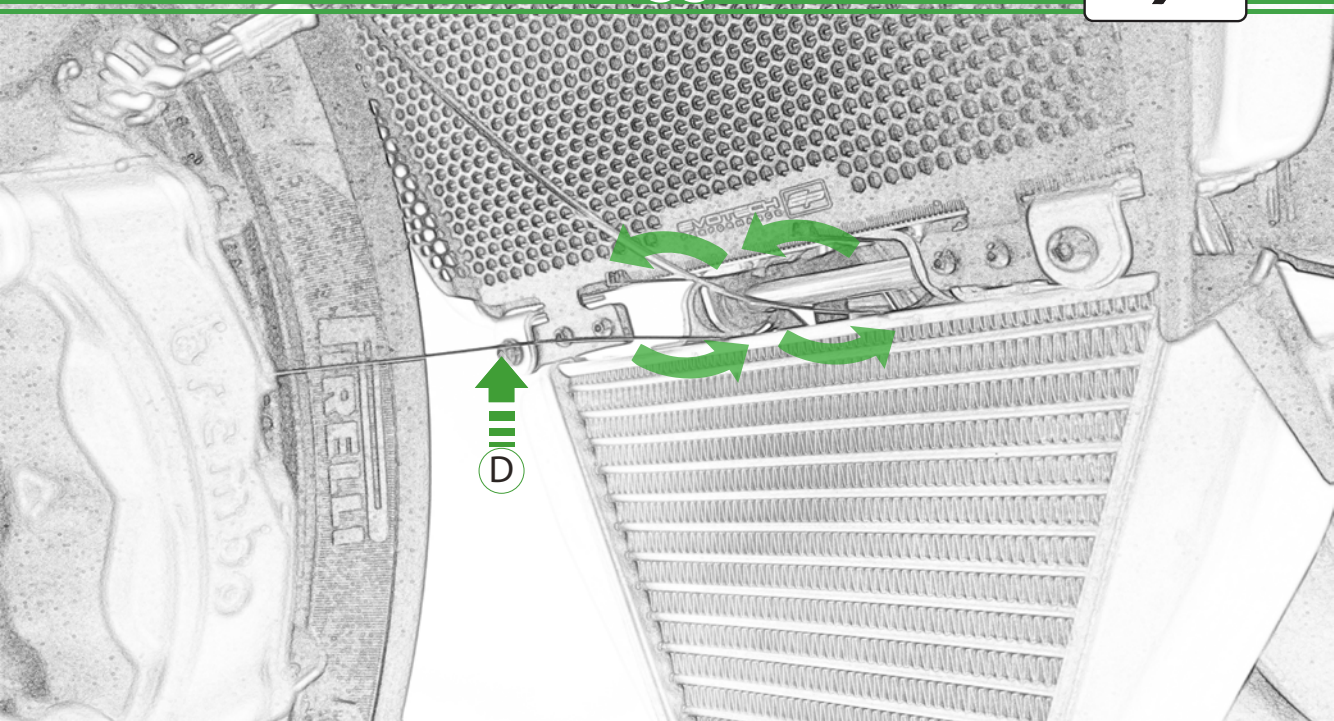

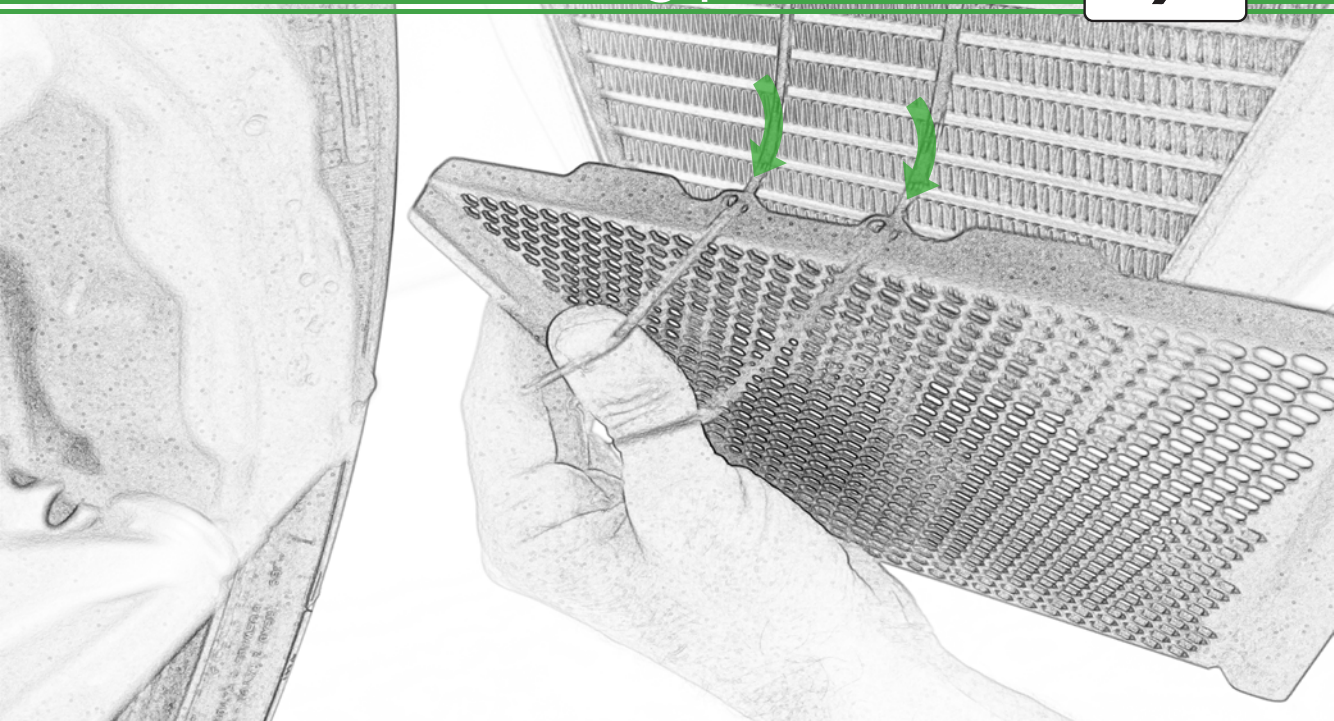

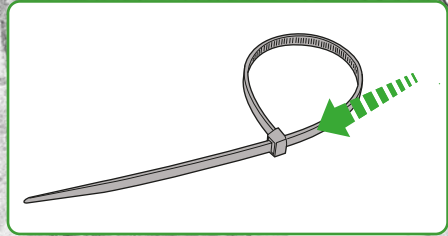
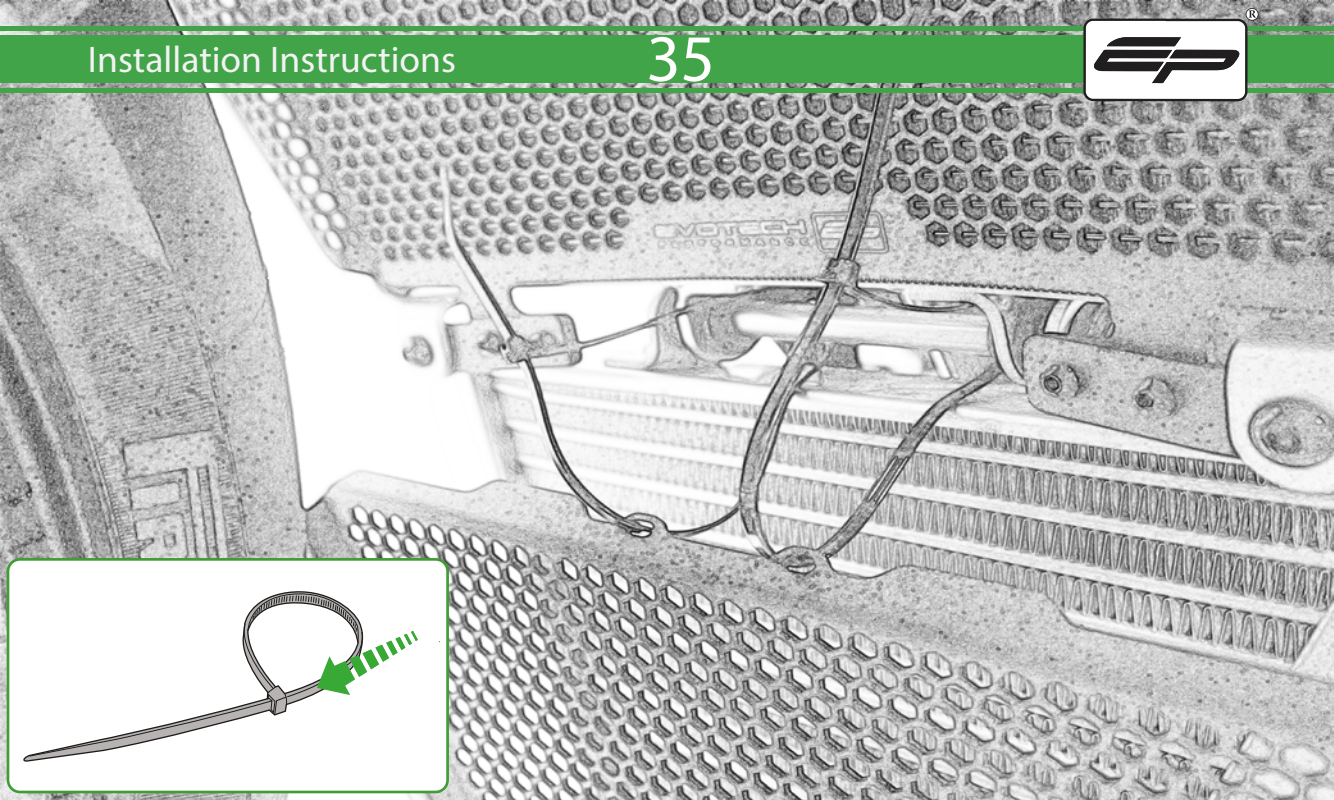

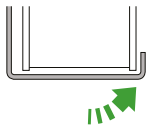
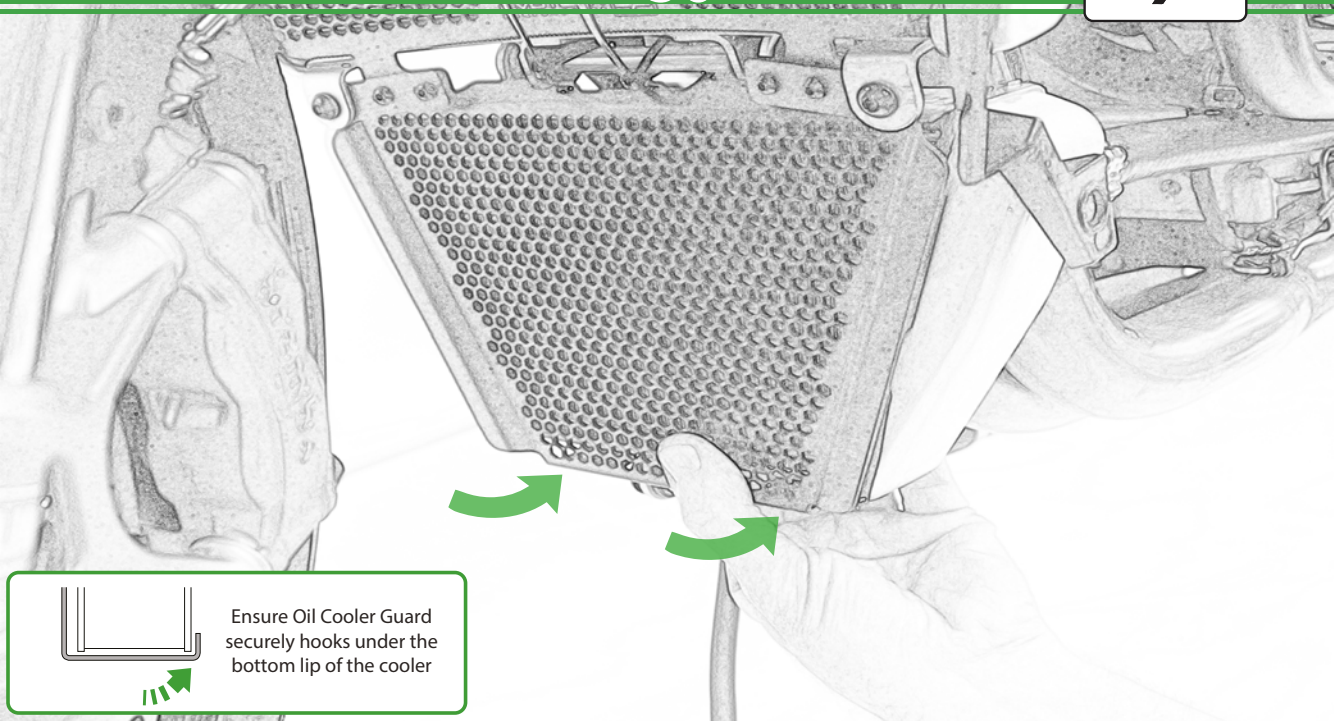

Ensure Oil Cooler Guard  
securely hooks under the  
bottom lip of the cooler

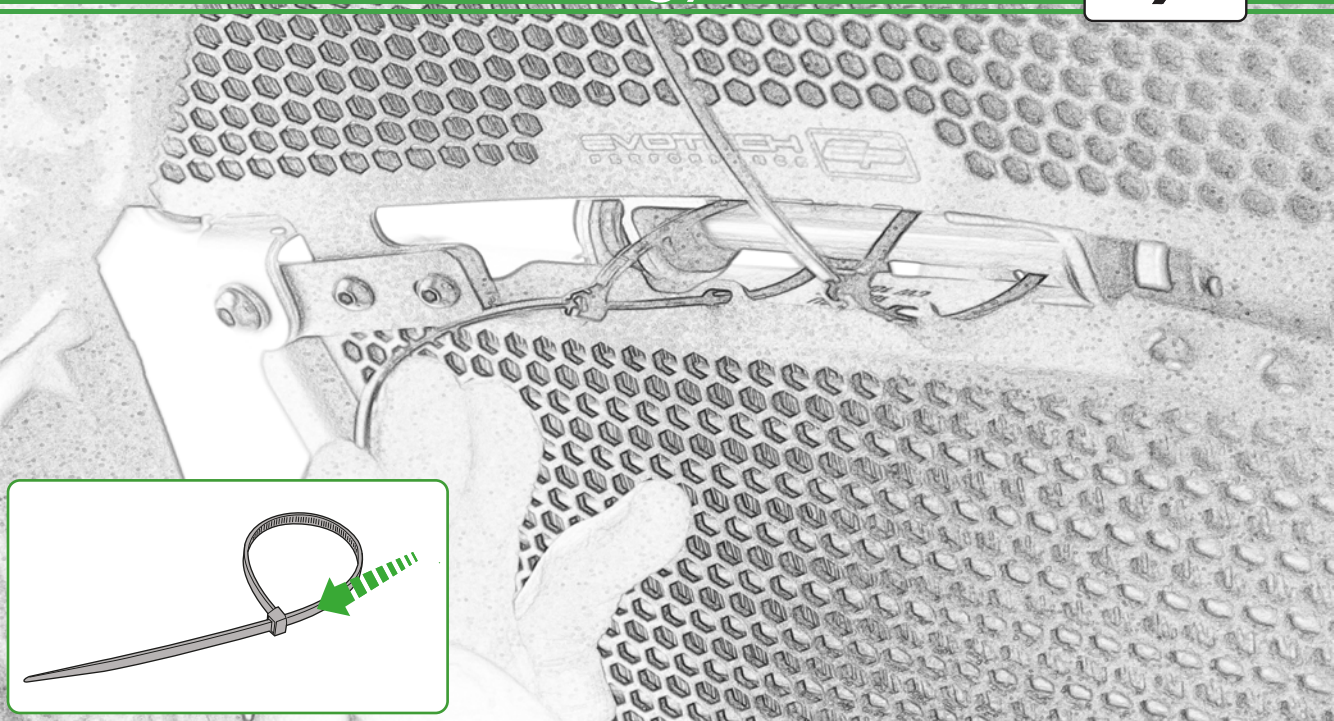

EVOTECH  
PERFORMANCE

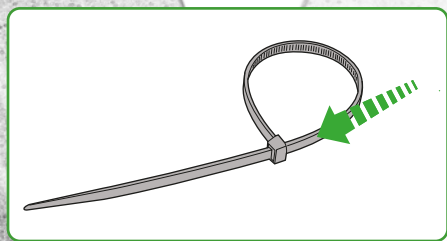

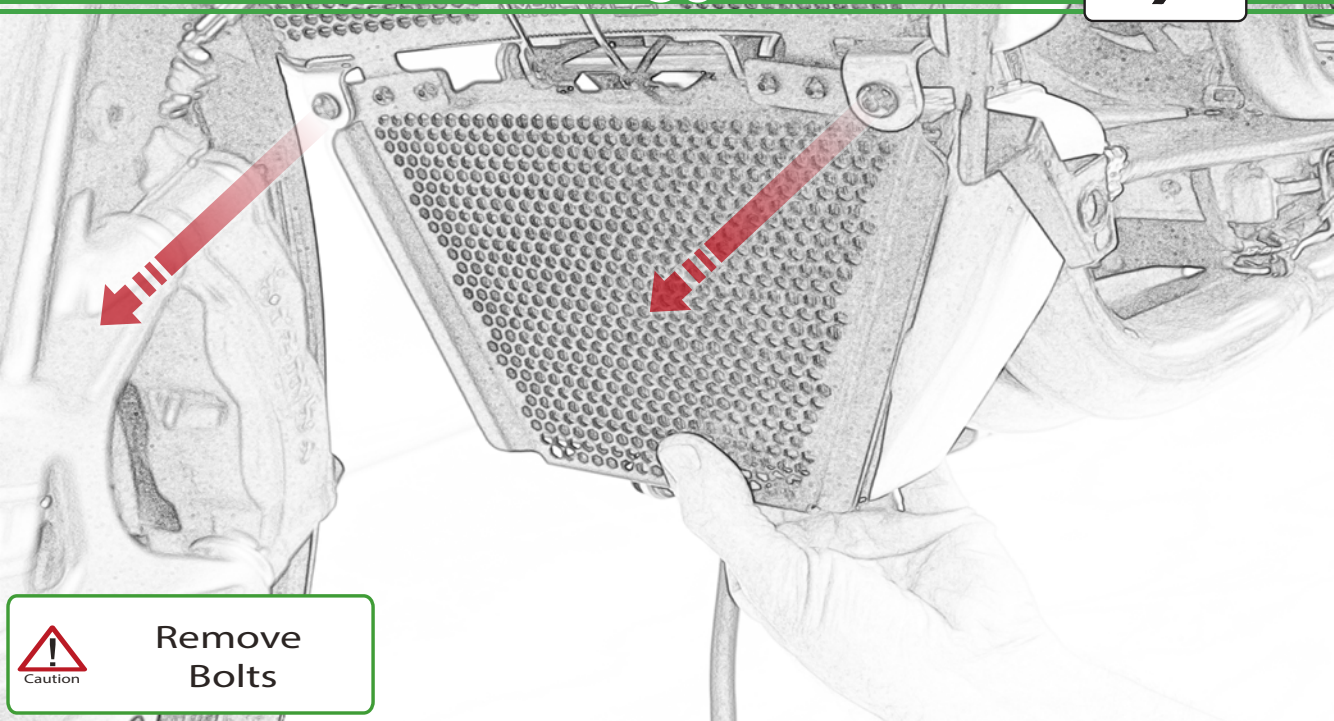

Caution

Remove  
Bolts



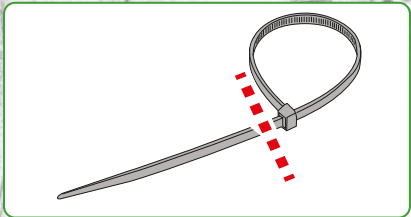
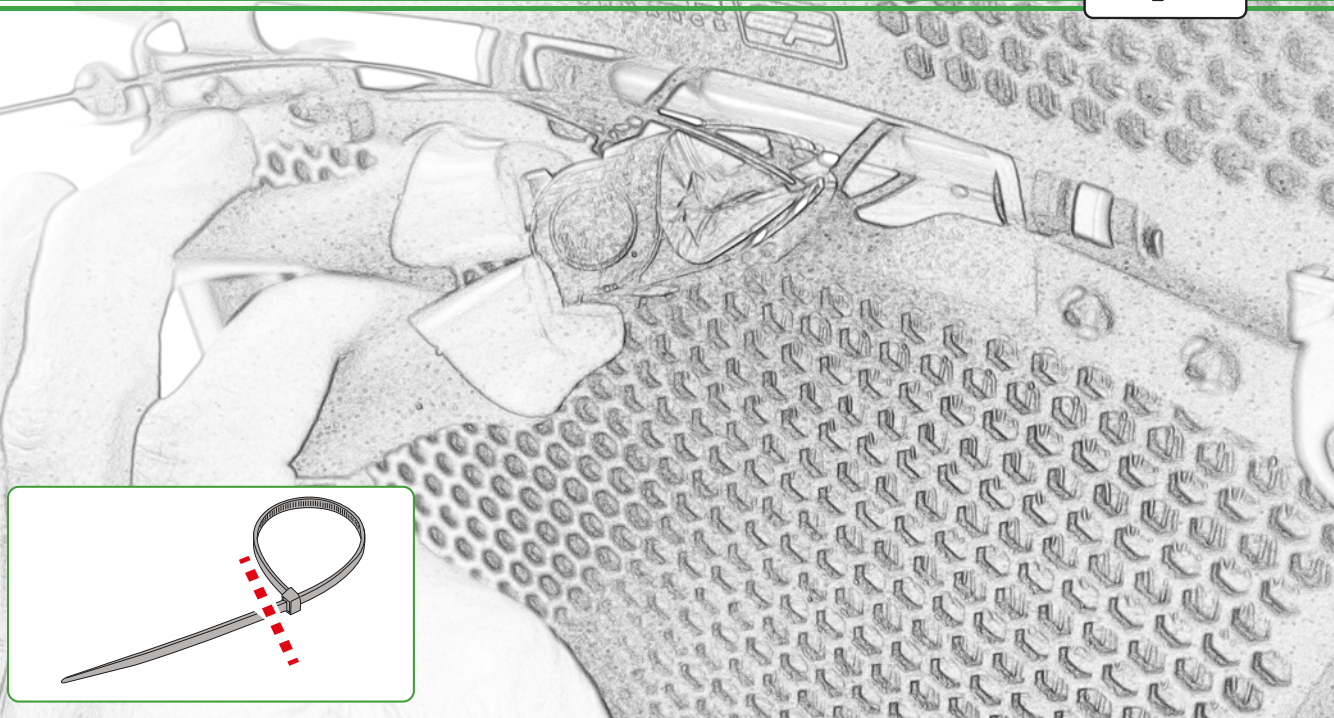



Reverse Stages

24 - 19



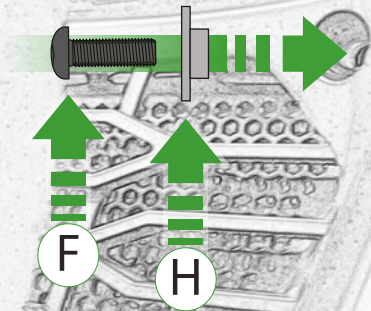

Repeat  
Both Sides

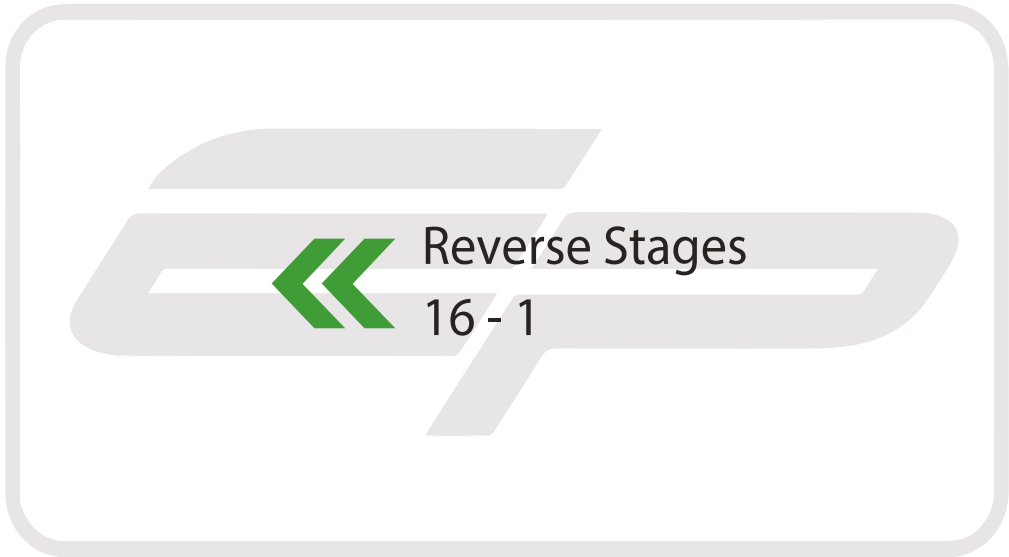



## **ESSENTIAL CHECKS**

It is recommended that periodic inspections are made to ensure that dirt and debris have not become trapped between the guard and the radiator/oil cooler. Such dirt and debris would reduce the cooling efficiency of the radiator/oil cooler.

It is recommended that periodic inspections are made to ensure that all fixings are fully tightend.



**EVOTECH**®  
P E R F O R M A N C E

[www.evotech-performance.com](http://www.evotech-performance.com)