

# TRIMMING SUNDRIES & FASTENERS

Refer to Retainer Specification Chart on pages 475-489



**21496**  
(357-853-585-A)  
White Nylon

Trim Panel Retainer  
With Nylon Grommet  
VW Golf & Passat and Audi B3

UNIT PACKAGE: 15



**21783**  
(VW: 6Q0-868-297)  
Black Nylon

Trim Panel Retainer  
Golf, GTI, R32 &  
Rabbit 2006 - On

UNIT PACKAGE: 15



**18861**  
(90467-10162)  
White Nylon

Scuff Plate Retainer  
Toyota Celica 1993 - On

UNIT PACKAGE: 15



**22243**  
(Honda: 91560-S04-003)  
White Nylon

Side Panel Moulding Retainer  
Honda Accord 2015 - 1998  
Honda Civic 2011 - 2007

UNIT PACKAGE: 25



**22057**  
(BMW: 51498123832;  
51490151605; 5149810579)  
Black Nylon

Trim Panel Retainer  
BMW 3, 5, 6, 7, 8, X &  
Z Series 2012 - 1989

UNIT PACKAGE: 25



**21488**  
(11610605)  
Gray Nylon

Door Trim Panel Retainer  
Chevrolet Cruze 2011 - On

UNIT PACKAGE: 25



**22240**  
(GM: 11546588)  
Yellow Nylon

Trim Panel Retainer  
With Sealer  
Chevrolet Colorado &  
GMC Canyon 2015 - On

UNIT PACKAGE: 15



**21365**  
(13252118)  
Blue Nylon

Door Panel Retainer  
Cadillac, Chevrolet &  
GMC 2010 - On

UNIT PACKAGE: 25



**21896**  
Gray Nylon

Trim Panel Retainer  
Renault & Dacia

UNIT PACKAGE: 25



**19719**  
(67921-32010)  
White Nylon

Scuff Plate Retainer  
Toyota Avalon, Camry  
& Corolla 1997 - On

UNIT PACKAGE: 15



**21977**  
(Renault & Dacia: 77-01-049-008)  
White Nylon

Trim Panel Retainer  
Peugeot, Citroen,  
Renault & Dacia

UNIT PACKAGE: 25



**20881**  
(5482103)  
White Nylon

Cowl Vent Retainer  
with Sealer  
Chevrolet Equinox &  
Pontiac Torrent 2005 - On

UNIT PACKAGE: 10

**Sec. 19**

**TRIMMING SUNDRIES & FASTENERS**

Refer to Retainer Specification Chart on pages 475-489



**22252**

(Mercedes-Benz: 000-991-63-98;  
000-991-63-98-M22)  
Yellow Nylon

Door Garnish Moulding  
Retainer with Sealer  
Mercedes-Benz G1450, G1550,  
M1320, M1550, R63, R320,  
R350 & R500 2010 - 2006

UNIT PACKAGE: 15



**21567**

(909130007)  
Gray Nylon

Pillar & Door Moulding  
Trim & Rear Light  
Retainer with Sealer  
Subaru B9 Tribeca, Forester, Impreza,  
Legacy & Outback 2005 - On

UNIT PACKAGE: 25



**22236**

(Mercedes: 006-988-43-78)  
White Nylon

Tailgate Garnish  
Retainer with Sealer  
Mercedes-Benz C Class,  
CLK Class, E Class, SL Class  
& SLK Class 1996 - On

UNIT PACKAGE: 25



**21591**

(909130109)  
Black Nylon

Front & Rear Door, Fender,  
Quarter Panel and Rocker Panel  
Moulding Clip  
Subaru B9 Tribeca, Forester, Impreza,  
Legacy & Outback 2003 - On

UNIT PACKAGE: 25



**21495**

(7L5-853-994)  
Blue Nylon

Trim Panel Retainer  
VW, Audi & Renault

UNIT PACKAGE: 25



**22133**

(Not Available from O.E.M.)  
Red Nylon

Fender & Pillar Moulding  
Retainer with Sealer  
Ford Edge & Lincoln MKX 2007 - On

UNIT PACKAGE: 10



**21450**

(703-867-299)  
Black Nylon

Side Panel &  
Interior Trim Retainer  
VW 2003 - 1993

UNIT PACKAGE: 25



**22207**

(Subaru: 909130088)  
Black Nylon

Fender, Rocker, Garnish, Pillar,  
Floor & Exterior Trim  
Retainer with Sealer  
Subaru Forester, Impreza,  
Legacy, Outback, B9 Tribeca  
& WRX 2005 - On

UNIT PACKAGE: 25



**22179**

(Ford: W718033-S300)  
Black Nylon

Rear Bumper  
Retainer with Sealer  
Ford Edge 2015 - On

UNIT PACKAGE: 10



**21107**

(90602-SX0-003)  
White Nylon

Cowl Vent Retainer  
Acura MDX, Honda Civic, Insight,  
Odyssey & Prelude 1995 - On

UNIT PACKAGE: 10

# TRIMMING SUNDRIES & FASTENERS

Refer to Retainer Specification Chart on pages 475-489



**20672**

(66820-3S500-C1)  
White Nylon

Cowl Vent Retainer  
Nissan Frontier & Xterra 1998 - On

UNIT PACKAGE: 25



**22063**

(Nissan: 01553-02903)  
White Nylon

Front Side Lower Fender  
Panel Bracket Retainer  
**Overall Length: 21mm**  
Infiniti Qx4 & Qx56 and Nissan Pathfinder,  
Frontier & Xterra 2010 - 1997

UNIT PACKAGE: 25



**19464**

(90667-SD4-003)  
Natural Nylon

Roof Lining Retainer  
Acura NSX, 2.2CL & 2.3CL 1991 - On

UNIT PACKAGE: 15



**21226**

(75867-02010)  
Black Nylon

**Overall Length: 15.5mm**  
Corolla 2009 - On

UNIT PACKAGE: 25



**21012**

(75867-AA010)  
Black Nylon

Rocker Panel &  
Scuff Plate Retainer  
Lexus ES300 & ES330 2002 - On  
Toyota Avalon, Camry, Scion & Solara 2004 - On

UNIT PACKAGE: 15

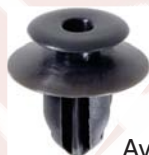

**21538**

(75867-33030)  
Charcoal Nylon

**Overall Length: 18.5mm**  
Avalon, Camry, Prius, Scion, Sienna,  
Solara & Venza 2000 - On

UNIT PACKAGE: 25



**21088**

(90321122)  
White Nylon

Door Panel Retainer  
Saturn Ion 2003 - On

UNIT PACKAGE: 50



**22056**

(Toyota: 75867-30130)  
White Nylon

Rocker Moulding Retainer  
with Sealer  
Lexus CT 200h, ES 300h, ES 350,  
GS 300, GS 350, GS 430, GS 460,  
GS 450h, HS 250h, IS 250, IS 350,  
IS F, LS 460, LS 600h & LX 570 and  
Toyota Land Cruiser 2006 - On

UNIT PACKAGE: 25



**20932**

(G18K-51-SJ3)  
White Nylon

Door Trim Panel  
Retainer with Sealer  
Mazda 3, 5, 6, CX-7,  
Miata & Protege 2001 - On

UNIT PACKAGE: 10



**21678**

(Mazda: NE51-51-SJ3A)  
Black Nylon

Moulding Retainer  
With Sealer  
CX-9 & Miata 2006 - On

UNIT PACKAGE: 10

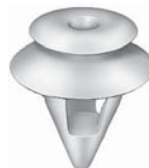

**18875**

(67771-16170)  
White Nylon

Door Trim Panel Retainer  
Toyota Tercel 1991 - On

UNIT PACKAGE: 25

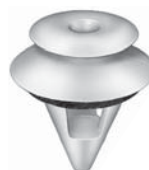

**20473**

(67771-12070)  
White Nylon

Door Panel & Rocker Moulding  
Retainer with Sealer  
Lexus SC300/400 and  
Toyota Avalon &  
Corolla 1992 - On

UNIT PACKAGE: 15

**Sec. 19**

**TRIMMING SUNDRIES & FASTENERS**

Refer to Retainer Specification Chart on pages 475-489



**21690**

(Mitsubishi: MR322000)  
White Nylon

Trim Panel Retainer with Sealer  
Diamante, Eclipse, Galant, Montero &  
Outlander 2000 - On

UNIT PACKAGE: 25



**21489**

(11610606)  
Yellow Nylon

Door Trim Panel Retainer  
Chevrolet Cruze 2011 - On

UNIT PACKAGE: 25



**19334**

(MB566720)  
Natural Nylon

Rear Pillar Trim &  
Air Inlet Grille Retainer  
Mitsubishi Eclipse 1994 - On

UNIT PACKAGE: 15



**21364**

(13252119)  
Green Nylon

Door Panel Retainer  
Buick, Cadillac, Chevrolet  
& GMC 2010 - On

UNIT PACKAGE: 25



**22251**

(Land Rover: LR013135)  
White Nylon

Trim Panel, Tail Gate & Luggage  
Compartment Retainer with Sealer  
Land Rover LR3, Range Rover Sport &  
Range Rover Sport Supercharge 2009 - 2005

UNIT PACKAGE: 15



**22278**

(GM: 11546963; 11547601)  
Gray Nylon

Door Panel Retainer  
Cadillac Escalade, Chevrolet Silverado,  
Suburban & Tahoe and GMC Sierra &  
Yukon 2015 - On

UNIT PACKAGE: 25

## AN IMPROVED FASTRACK WEB

FasTrack is an easy-to-use, web based system designed to assist body shops and dealerships in recovering the cost of body repair clips and fasteners used in daily collision repairs.

### Features:

- **New Look:** User-friendly design and intuitive functions with over 10,000 of our collision repair fasteners
- **Repair Kits:** Simple to build your own kits or choose one of the other preloaded kits
- **Add Part Numbers with Ease:** Add non-auveco items. Add new numbers on the fly during invoicing
- **OEM Numbers:** Available with the latest OEM pricing and ability to use during invoicing
- **Reports:** Page by page user selected printing to gather usage information
- **Inventory Management:** Allows shop and/or the distributor to track inventory
- **Labeling:** End user can print individual bar code labels and lid labels
- **Barcode Scanning:** Done with our app using any smart phone or with our wedge scanner
- **Online Catalog & OEM Crossover**
- **Repair Type:** Requested by many insurance companies you can now add Repair Type during invoice processing (Front Bumper, Front Fender, Door, etc.)
- **CCC® Integration:** Enables users to import FasTrack invoices into CCC's Estimating system
- **Tutorial Videos:** Found in the Help Menu, videos demonstrating all FasTrack features
- **Security:** Site protected by Verisign Internet Security.

Questions or concerns.

Call 1-800-354-9816 or email [fastrack.support@auveco.com](mailto:fastrack.support@auveco.com)

# TRIMMING SUNDRIES & FASTENERS

Refer to Retainer Specification Chart on pages 475-489



**22279**

(GM: 11546964; 11547602)  
Yellow Nylon

Door Panel Retainer  
Cadillac Escalade, Chevrolet Suburban,  
Tahoe and GMC Yukon 2015 - On

UNIT PACKAGE: 25



**21819**

Yellow Nylon

Retainer  
VW, Audi, SEAT, Skoda & Ford

UNIT PACKAGE: 25



**21853**

(VW: 7M0-867-299-K, 7M3-867-299;  
Land Rover: DYC500020;  
Ford: 1008068)  
Yellow Nylon

Door Trim Panel  
Retainer with Sealer  
Land Rover 1997 - On  
VW & Audi 1999 - On

UNIT PACKAGE: 25



**21787**

(BMW: 51-77-7-171-002)  
White Nylon

Wheel Arch Cover &  
Footboard Retainer with Sealer  
BMW X Series 2006 - On  
Mini-Cooper S & SX Series 2011 - On

UNIT PACKAGE: 25



**21412**

(TD12-51-SJ3A)  
Gray Nylon

Rocker Moulding  
Retainer with Sealer  
Mazda 6 GT 2010 - On

UNIT PACKAGE: 15



**21893**

(VW: 5J0-867-276)  
White Nylon

Trim Panel Retainer With Sealer  
VW, Audi, SEAT & Skoda

UNIT PACKAGE: 15



**21996**

(VW: 8P0-868-243)  
Yellow & White Nylon

Trim Panel Retainer with Sealer  
VW, Audi, SEAT & Skoda

UNIT PACKAGE: 10



**21995**

(VW: 8Z0-867-646)  
White Nylon

Trim Panel Retainer with Sealer  
VW, Audi, SEAT & Skoda

UNIT PACKAGE: 10



**22244**

(Land Rover: LR034389; LR053837)  
White Nylon

Pillar Retainer with Sealer  
Land Rover Discovery &  
Range Rover Sport 2010 - On

UNIT PACKAGE: 15



**21795**

(Toyota: 67773-0E020)  
White Nylon

Door Panel Retainer with Sealer  
**Overall Length: 20mm**  
Lexus RX350 2009 and Toyota Camry 2012 - On

UNIT PACKAGE: 25



**22132**

(Toyota: 53813-48011)  
Gray Nylon

Front Fender Retainer with Sealer  
Lexus HS 250h, RX 350 & RX 450h and  
Toyota Prius & Sienna 2010 - On

UNIT PACKAGE: 10



**20829**

(6505534-AA)  
Black Nylon

Door Trim Panel Retainer  
Chrysler Concorde, Intrepid,  
LHS & 300M 1998 - On

UNIT PACKAGE: 50



**22093**

(Land Rover: DKP5279L)  
Black Nylon

Trim Panel Retainer  
Land Rover Discovery &  
Defender 2004 - 1989

UNIT PACKAGE: 25

**Sec. 19**

**TRIMMING SUNDRIES & FASTENERS**

Refer to Retainer Specification Chart on pages 475-489



**19810**  
(N807943-S)  
Black Nylon

Trim Panel Retainer  
Ford Mustang 1995 - On

UNIT PACKAGE: 50



**17218**  
(21042045, 21042053,  
21042058, 21042104)  
Natural Nylon

Door Trim Panel Retainer  
GM Saturn 1991 - On

UNIT PACKAGE: 50



**19213**  
(6503709)  
Natural Nylon

Trim Panel Retainer  
Dodge Ram 1994 - On

UNIT PACKAGE: 50



**21777**  
(BMW: 51-47-1-945-266)  
Black Nylon

Trunk Luggage Compartment  
& Sill Trim Retainer  
3, 5 & M Series 1983 - On

UNIT PACKAGE: 25



**12565**  
(N801925-S)  
Black Nylon

Door Trim Panel Retainer  
Ford 1981 - On

UNIT PACKAGE: 25



**21091**  
(22691056)  
Black Nylon

Tailgate Moulding  
Retainer with Sealer  
Cadillac Escalade EXT  
and Chevrolet Avalanche 2007 - On

UNIT PACKAGE: 15



**17124**  
(N805155-S)  
Black Nylon

Trim Panel Retainer  
Ford 1985 - On

UNIT PACKAGE: 50



**20274**  
(Not Supplied by O.E.M.)  
White Nylon

Door Panel Retainer  
**Use with Auveco 20275**  
Chrysler LH Series 2000 - On

UNIT PACKAGE: 25



**22259**  
(GM: 11547047)  
Black Nylon

Headliner Retainer  
Cadillac CT6 & ELR and  
Chevrolet Impala 2015 - On

UNIT PACKAGE: 25



**19802**  
(MB566719)  
White Nylon

Door Moulding Retainer  
Chrysler Concorde, Eagle Talon  
& Sebring 1996 - On

UNIT PACKAGE: 15



**13470**  
(N802900)  
White Nylon

Door Trim Panel Retainer  
Ford

UNIT PACKAGE: 25



**17102**  
(GM: 10143422;  
Ford: N805612-S100;  
AMC: 8934-202-599)  
White Nylon

Trim Panel Retainer  
Ford Tempo & Topaz, Jeep Eagle  
& Premier and Pontiac 1988 - On

UNIT PACKAGE: 50



**18848**  
(F58Z-16237A02-A)  
Yellow Nylon

Door Trim Panel Retainer  
Ford Windstar 1995 - On

UNIT PACKAGE: 25

# TRIMMING SUNDRIES & FASTENERS

Refer to Retainer Specification Chart on pages 475-489



**20944**  
(11588863)  
Green Nylon

Door Trim Panel Retainer  
Buick Terraza, Chevrolet  
Uplander, Pontiac Montana  
& Saturn Relay 2005 - On

UNIT PACKAGE: 25



**18175**  
(10158124)  
Natural Nylon

Trim Panel Retainer  
GM, Chrysler 1992 - On

UNIT PACKAGE: 50



**21346**  
(10350983)  
White Nylon

Trim Panel Retainer with Sealer  
**Mates with Auveco 21347**  
Cadillac, Chevrolet  
& Pontiac 2004 - On

UNIT PACKAGE: 15



**21532**  
(Not Available from O.E.M.)  
White Nylon

Front Bumper Cover Retainer  
GM Trucks 2008 - On

UNIT PACKAGE: 25

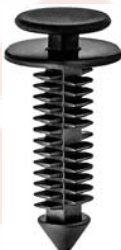

**11671**  
(387182-S)  
Black Nylon

Seat Back Panel Retainer  
Ford 1977 - On

UNIT PACKAGE: 25



**18391**  
(15694099)  
Natural Nylon

Rear Door Trim Panel Retainer  
Chevrolet Astro &  
GMC Safari Mini Vans 1993 - On

UNIT PACKAGE: 15



**21516**  
(357-853-585)  
White Nylon

Retainer with  
Black Nylon Grommet  
VW Golf A2 & A3 and Audi

UNIT PACKAGE: 25



**21794**  
(Ford: W713579-S300)  
White Nylon

Tail Light Mounting  
Retainer with Sealer  
Ford Escape, Explorer, Focus  
MKZ & Zephyr 2006 - On

UNIT PACKAGE: 10



**20634**  
(GM: 10363811; 22722859)  
White Nylon

Door Panel Retainer  
**Use with Auveco 20635**  
Oldsmobile Alero &  
Pontiac Grand Am 2002 - On

UNIT PACKAGE: 25



**21383**  
(11561499)  
White Nylon

Trim Panel Retainer  
**Use with Auveco 21384**  
Chevrolet Traverse 2010 - On

UNIT PACKAGE: 25



**20995**  
(11562043)  
White Nylon

Door Panel  
Retainer with Sealer  
Cadillac SRX & STS,  
Chevrolet Cobalt & HHR and  
Hummer H3 2004 - On

UNIT PACKAGE: 15



**20996**  
(11562044)  
Yellow Nylon

Door Panel  
Retainer with Sealer  
Cadillac SRX & STS, Chevrolet  
Cobalt & HHR and  
Hummer H3 2004 - On

UNIT PACKAGE: 15

**Sec. 19**

**TRIMMING SUNDRIES & FASTENERS**

Refer to Retainer Specification Chart on pages 475-489



**20998**  
(11562256)  
Black Nylon Pin  
& White Nylon Grommet

Door Panel  
Retainer with Sealer  
Chevrolet Cobalt, HHR  
& Full-Size Van 2005 - On

UNIT PACKAGE: 15



**20999**  
(11562257)  
Green Nylon Pin &  
Yellow Nylon Grommet

Door Panel  
Retainer with Sealer  
Chevrolet Cobalt &  
HHR 2006 - On

UNIT PACKAGE: 15



**21535**  
(11571118)  
White Nylon

Door Panel Retainer  
& Grommet  
Buick Enclave & Lucerne,  
Cadillac DTS, Chevrolet  
Traverse, GM "G" Vans,  
GMC Acadia and  
Hummer H2 2008 - On

UNIT PACKAGE: 15



**21536**  
(11571119)  
Yellow Nylon

Door Panel Retainer  
& Grommet  
Buick Enclave & Lucerne,  
Cadillac DTS, Chevrolet  
Cobalt, Colorado, Traverse,  
GM "G" Vans, GMC Acadia  
& Canyon and Pontiac G5 &  
Pursuit 2008 - On

UNIT PACKAGE: 15



**19527**  
(10408480)  
Yellow Nylon

Door Garnish Moulding &  
Pillar Trim Panel Retainer  
**Overall Length: 25/32"**

Buick Century & Regal, Chevrolet Venture,  
Olds Intrigue & Silhouette, Pontiac Grand Prix  
and Trans Sport 1997 - On

UNIT PACKAGE: 25



**19275**  
(10287971)  
White Nylon

Door Trim Panel Retainer  
**Overall Length: 25/32"**  
Buick Century & Regal, Chevrolet Venture, Olds  
Silhouette and Pontiac Trans Sport 1997 - On

UNIT PACKAGE: 50



**16938**  
(15638413, 15963179)  
Black Nylon

Trim Panel Retainer  
**Overall Length: 29/32"**  
GM Trucks 1991 - On

UNIT PACKAGE: 50



**11797**  
(387477-S)  
White Nylon

Interior Trim Panel  
**Overall Length: 15/16"**  
Ford 1977 - On

UNIT PACKAGE: 50



**19356**  
(15986673)  
White Nylon

Front & Rear Door  
Trim Panel Retainer  
**Overall Length: 1-3/32"**  
GM Trucks S10 & S15 1996 - On

UNIT PACKAGE: 50



**17075**  
(389144-S)  
White Nylon

Trim Panel Retainer  
**Overall Length: 1-5/32"**  
Ford 1981 - On

UNIT PACKAGE: 50



**19270**  
(10285935)  
White Nylon

Trim Panel Retainer  
**Overall Length: 1-3/16"**  
Buick Century & Regal,  
Chevrolet Venture, GM Truck  
Express/Savana, Olds Silhouette &  
Pontiac Trans Sport 1997 - On

UNIT PACKAGE: 50



# TRIMMING SUNDRIES & FASTENERS

Refer to Retainer Specification Chart on pages 475-489



**20814**  
(10305191)  
White Nylon

Door Panel Retainer  
**Overall Length: 1-3/16"**  
Chevrolet Impala, Lumina  
& Monte Carlo 2000 - On

UNIT PACKAGE: 50



**16695**  
(10153057)  
White Nylon

Door Trim Panel Retainer  
**Overall Length: 1-1/4"**  
GM 1982 - On

UNIT PACKAGE: 25



**20338**  
(10421018)  
White Nylon

Door Trim  
Panel Retainer  
**Overall Length: 1-9/16"**  
GM 1997 - On

UNIT PACKAGE: 25



**22231**  
(VW: 1K6-837-200B)  
Black Nylon

Door Panel Retainer  
**Overall Length: 13mm**  
VW Golf V, GTI, Jetta &  
R32 2010 - 1999

UNIT PACKAGE: 25



**21137**  
(07-13-0-702-516)  
Black Nylon

Rear Quarter Wheel Opening  
Moulding Retaining Clip  
**Overall Length: 14mm**  
Mini-Cooper 2002 - On

UNIT PACKAGE: 25



**21785**  
(Volvo: 30624192)  
Black & Yellow Nylon

Rocker Panel Moulding Retainer  
**Overall Length: 15mm**  
S60 & V60 2011 - On

UNIT PACKAGE: 25



**21786**  
(Volvo: 30653441)  
Black & White Nylon

Door Trim, Luggage Compartment  
& Armrest Tray Trim Retainer  
**Overall Length: 15.5mm**  
C30, S40, V50, V60 & XC60 2004 - On

UNIT PACKAGE: 25



**22008**  
(Hyundai: 85495-2E050)  
Black Nylon

Headliner Retainer  
**Overall Length: 15.5mm**  
Hyundai & Kia

UNIT PACKAGE: 50



**22336**  
(GM: 90560163)  
White Nylon

Interior Trim Panel Retainer  
**Overall Length: 16mm**  
Saturn Astra, L100, L200, L300, LW2,  
LW200, & LW300 2009 - 2000

UNIT PACKAGE: 25



**18824**  
(G350-68-AB1)  
White Nylon

Trim Panel Retainer  
**Overall Length: 16mm**  
Mazda 626, MX-6, Millenia, MX3, 929,  
Protégé, MPV Ford Probe 1990 - On

UNIT PACKAGE: 50



**21584**  
(693005370)  
White Nylon

Front Door & Lift Gate  
Trim Panel Retainer  
**Overall Length: 16mm**  
Subaru Impreza, Justy, Legacy &  
Outback 2007 - 1987

UNIT PACKAGE: 25

**Sec. 19**

**TRIMMING SUNDRIES & FASTENERS**

Refer to Retainer Specification Chart on pages 475-489



**20670**  
(01553-02821)  
Gray Nylon

Trim Panel Retainer  
**Overall Length: 16mm**  
Nissan Maxima 1988 - On

UNIT PACKAGE: 15



**22343**  
(Subaru: 909130096)  
Green Nylon

Cowl, Garnish, Headliner,  
Rocker, Pillar & Interior Trim Retainer  
**Overall Length: 17mm**  
Subaru B9 Tribeca, BRZ, Forester, Impreza, Legacy,  
Outback, WRX & XV Crosstrek 2005 - On

UNIT PACKAGE: 25



**21410**  
(90467-09212)  
White Nylon

Cowl Trim Retainer  
**Overall Length: 16mm**  
Toyota Camry 2010 - On

UNIT PACKAGE: 25



**21701**  
(Nissan: 85284-4J500)  
Black Nylon

Retainer with Sealer  
**Overall Length: 17mm**  
Infiniti I35 and Nissan Altima,  
Cube & Maxima 2011 - 02

UNIT PACKAGE: 10



**21686**  
(Toyota: 67771-32120)  
Green Nylon

Trim Panel Retainer with Sealer  
**Overall Length: 16.5mm**  
Lexus ES 300, GS 300, GS 450h,  
IS F, IS 250, LS 460, LS 600hL, RX 350,  
Scion XA and Toyota Prius 2001 - On

UNIT PACKAGE: 25



**21188**  
(82315-27000)  
Pink Nylon

Trim Panel Retainer  
**Overall Length: 17mm**  
Hyundai & Kia 2003 - On

UNIT PACKAGE: 15



**22048**  
(Subaru: 94078FA080)  
White Nylon

Trim Panel Retainer  
**Overall Length: 16.5mm**  
Forester, Impreza & XV Crosstrek 1994 - On

UNIT PACKAGE: 25



**22313**  
(Hyundai: 82315-2W000)  
Green Nylon

Door Panel, Interior Trim  
& Garnish Retainer  
**Overall Length: 17mm**  
Hyundai Santa Fe & Sonata 2013 - On  
Kia Forte & K900 2014 - On

UNIT PACKAGE: 25



**22152**  
(Land Rover: LR028939)  
White Nylon

Front Lower Fender &  
Exterior Trim Retainer  
**Overall Length: 16.5mm**  
Land Rover Evoque, HSE &  
Range Rover 2014 - 2012

UNIT PACKAGE: 25



**21149**  
(91560-S84-A01)  
White Nylon

Trim Panel Retainer  
**Overall Length: 17.5mm**  
Honda Accord & Element 2003 - On

UNIT PACKAGE: 25



**20558**  
(62217-13010)  
White Nylon

Garnish Moulding Retainer  
**Overall Length: 17mm**  
Lexus and Toyota Corolla,  
Matrix & 4 Runner 2003 - On

UNIT PACKAGE: 25



**20559**  
(GM: 88970345;  
Toyota: 90467-10167)  
Blue Nylon

Garnish Moulding Retainer  
**Overall Length: 17.5mm**  
Pontiac Vibe, Lexus and Toyota 2000 - On

UNIT PACKAGE: 25

# TRIMMING SUNDRIES & FASTENERS

Refer to Retainer Specification Chart on pages 475-489



**21240**  
(10369649)  
Green Nylon

Door Panel Retainer with Sealer  
**Overall Length: 17.5mm**  
Pontiac Torrent 2006 - On

UNIT PACKAGE: 25



**22269**  
(Ford: W716507-S300)  
White Nylon

Front & Rear Door,  
Body Side and Wheel Opening  
Moulding Retainer with Sealer  
**Overall Length: 17.5mm**  
Ford Transit Cargo & Passenger Van 2015 - On

UNIT PACKAGE: 15



**19109**  
(67771-30070)  
Natural Nylon

Door Trim Panel  
& Garnish Retainer  
**Overall Length: 18mm**  
Toyota Corolla Wagon, Tercel  
T-100 & Tacoma 2WD 1992 - On

UNIT PACKAGE: 25



**21574**  
(909130034)  
White Nylon

Door, Pillar, Rocker, Floor  
& Interior Trim Retainer  
**Overall Length: 18mm**  
Subaru Baja, Forester, Legacy &  
Outback 2008 - 03

UNIT PACKAGE: 25



**21139**  
(07-14-7-145-753)  
White Nylon

Body Side Moulding  
Retainer with Sealer  
**Overall Length: 18mm**  
Mini-Cooper 2002 - On

UNIT PACKAGE: 25



**21638**  
(91560-S0X-A01)  
White Nylon

Trim Panel Retainer with Sealer  
**Overall Length: 18mm**  
Honda Accord, CR-V, Fit  
& Odyssey 1999 - On

UNIT PACKAGE: 15



**21675**  
(91560-SZW-003)  
Green Nylon

Door Panel & Interior Trim Retainer  
**Overall Length: 18mm**  
Honda Civic 2012 - On

UNIT PACKAGE: 25



**19466**  
(91560-SZ3-003)  
White Nylon

Door Trim Panel Retainer  
**Overall Length: 18mm**  
Acura 3.5RL 1996 - On

UNIT PACKAGE: 15



**21070**  
(Hyundai: 82315-38000  
GM: 94530565)  
White Nylon

Trim Panel Retainer  
**Overall Length: 18mm**  
Chevrolet Aveo 2004 - On  
Hyundai Accent, Santa Fe, Sonata  
Tiburon & XG300/350 1999 - On  
and Kia Optima, Rio & Sorento 2001 - On

UNIT PACKAGE: 25



**22312**  
(Kia: 0K95-A-68401)  
Gray Nylon

Exterior & Interior Moulding Retainer  
**Overall Length: 18mm**  
Kia Soul, Sedona & Sportage 2010 - On

UNIT PACKAGE: 50



**20983**  
(GJ6R-68-ABX)  
White Nylon

Trim Panel Retainer with Sealer  
**Overall Length: 18mm**  
Mazda 3, 5, 6, Miata & RX-8 2003 - On

UNIT PACKAGE: 15



**22305**  
(Mercedes: 001-991-26-98)  
Yellow Nylon

Door Trim Panel Retainer with Sealer  
**Overall Length: 18mm**  
Mercedes-Benz CLS400, CLS550, CLS63,  
S500, S600 & S63 2012 - On

UNIT PACKAGE: 15

**Sec. 19**

**TRIMMING SUNDRIES & FASTENERS**

Refer to Retainer Specification Chart on pages 475-489



**22309**

(Mercedes: 000-991-01-98; 011-988-76-78)  
White Nylon

Door Upper Pillar Trim &  
Trunk Lining Retainer with Sealer  
**Overall Length: 18mm**  
Mercedes-Benz C250, C300, C350,  
C63, GLA250, GLA45, GLK250  
& GLK350 2013 - On

UNIT PACKAGE: 15



**19203**

(67771-89104)  
Natural Nylon

Quarter Board  
Inside Trim Panel Retainer  
**Overall Length: 18.5mm**  
Toyota Truck 2WD 1997 - 91

UNIT PACKAGE: 15



**21208**

(91560-SLJ-J01)  
Gray Nylon

Door Trim Panel Retainer  
**Overall Length: 18mm**  
Acura RDX and Honda  
Civic, CR-V & Pilot 2009 - On

UNIT PACKAGE: 10



**20411**

(91560-S84-A11)  
Black Nylon

Windshield Garnish Pillar  
Retainer  
**Overall Length: 18.5mm**  
Acura 3.2CL, Honda Accord,  
Insight & Odyssey 1998 - On

UNIT PACKAGE: 15



**19731**

(84915-0W000)  
White Nylon

Trim Panel Retainer  
**Overall Length: 18.5mm**  
Nissan Pathfinder 1995 - On

UNIT PACKAGE: 15



**21814**

(Peugeot: 6991.S6;  
Renault: 77-03-077-468)  
White Nylon

Door Panel Retainer  
**Overall Length: 18.5mm**  
Renault, Dacia,  
Peugeot and Citroen

UNIT PACKAGE: 25



**21998**

(Nissan: 01553-08101)  
Yellow & White Nylon

Trim Panel Retainer  
**Overall Length: 18.5mm**  
Nissan

UNIT PACKAGE: 10



**21554**

(91560-S7A-003)  
Black Nylon

Trim Panel Retainer  
With Sealer  
**Overall Length: 18.5mm**  
Honda Crosstour, Fit &  
Odyssey 2010 - 05

UNIT PACKAGE: 25

**HAVE YOU VISITED US ONLINE?**

Auveco's website has been completely renovated.  
Our new design is user friendly with easy  
navigation and ordering.

Product is searchable by car make, OEM number  
and category, as well as, several attribute drop  
downs within individual categories. All product  
also has stock availability listed.

Make sure to head over to **www.auveco.com**  
to receive up to date information on  
all our products.



**19145**

(91560-SP0-003)  
Gray Nylon

Front & Rear Door  
Trim Panel Retainer  
**Overall Length: 18.5mm**  
Acura Integra & Legend and Honda  
Accord, Civic, Prelude, Odyssey &  
Del Sol 1991 - On

UNIT PACKAGE: 25

# TRIMMING SUNDRIES & FASTENERS

Refer to Retainer Specification Chart on pages 475-489



**21974**

(Peugeot & Citroen: 6992.82)  
White Nylon

Trim Panel Retainer with Sealer  
**Overall Length: 18.5mm**  
Peugeot & Citroen

UNIT PACKAGE: 25



**21978**

(Peugeot & Citroen: 6992.J4)  
White Nylon

Trim Panel Retainer  
**Overall Length: 18.5mm**  
Peugeot & Citroen

UNIT PACKAGE: 25



**22005**

(Hyundai: 82315-33020)  
White Nylon

Trim Panel Retainer  
**Overall Length: 18.5mm**  
Hyundai & Kia 1995 - On

UNIT PACKAGE: 50



**20959**

(91560-S9A-A01)  
Blue Nylon

Door Panel Retainer  
**Overall Length: 19mm**  
Acura TL & TSX and Honda Accord,  
Civic, CRV & Odyssey 2002 - On

UNIT PACKAGE: 25



**21676**

(91560-SZW-J01)  
Yellow Nylon

Windshield Moulding  
& Interior Trim Retainer  
**Overall Length: 19mm**  
Honda Civic 2012 - On

UNIT PACKAGE: 25



**21916**

(Peugeot & Citroen: 8335.TE;  
Renault & Dacia: 82-00-700-969)  
Yellow Nylon

Trim Panel Retainer  
**Overall Length: 19mm**  
Peugeot, Citroen, Renault & Dacia

UNIT PACKAGE: 25



**21895**

(Peugeot & Citroen: 6991.Z1;  
Renault & Dacia: 82-00-909-084)  
Blue Nylon

Trim Panel Retainer  
**Overall Length: 19mm**  
Peugeot, Citroen, Renault & Dacia

UNIT PACKAGE: 25



**21917**

Yellow Nylon

Trim Panel Retainer with Sealer  
**Overall Length: 19mm**  
Renault & Dacia

UNIT PACKAGE: 15



**22285**

(Mini-Cooper: 07-14-6-962-771)  
Red Nylon

Rocker Moulding &  
Pillar Retainer with Sealer  
**Overall Length: 19mm**  
Mini-Cooper 2006 - On

UNIT PACKAGE: 15



**22156**

(Land Rover: IPN500050)  
White Nylon

Windshield Glass Side Moulding  
Retainer with Sealer  
**Overall Length: 19mm**  
Land Rover HSE & Range Rover Sport 2012 - 2006

UNIT PACKAGE: 15



**22003**

(Hyundai: 82315-2P000)  
White Nylon

Trim Panel Retainer  
**Overall Length: 19mm**  
Hyundai & Kia 1999 - On

UNIT PACKAGE: 50



**21944**

(Peugeot & Citroen: 8742.G2)  
Green & White Nylon

Trim Panel Retainer  
**Overall Length: 19.3mm**  
Peugeot, Citroen, Renault & Dacia

UNIT PACKAGE: 10

**Sec. 19**

**TRIMMING SUNDRIES & FASTENERS**

Refer to Retainer Specification Chart on pages 475-489



**21360**  
(85849-3B000)  
White Nylon

Headliner & Trim Panel Retainer  
**Overall Length: 19.5mm**  
Hyundai 2001 - On

UNIT PACKAGE: 25



**20668**  
(01553-09791)  
White Nylon

Trim Panel Retainer  
**Overall Length: 20mm**  
Nissan & Infiniti 1999 - On

UNIT PACKAGE: 15



**21414**  
(80999-VE000)  
White Nylon

Trim Panel Retainer with Sealer  
**Overall Length: 19.5mm**  
Infiniti & Nissan 1993 - On

UNIT PACKAGE: 25



**20437**  
(90467-09206)  
White Nylon

Trim Panel Retainer with Sealer  
**Overall Length: 20mm**  
Toyota RAV 4 & Tundra 2000 - On

UNIT PACKAGE: 15



**20575**  
(Toyota: 67771-12080;  
GM: 88970656)  
Yellow & White Nylon

Door Panel & Rocker  
Moulding Retainer  
**Overall Length: 19.5mm**  
Toyota & Lexus 1998 - On  
Pontiac Vibe 2003 - On

UNIT PACKAGE: 15



**21102**  
(90467-A0005)  
White Nylon

Door Trim Panel Retainer with Sealer  
**Overall Length: 20mm**  
Lexus ES 350, GX 470, IS 250, IS 350, IS  
F, LS 460 & LS 600HL and Toyota Camry,  
FJ Cruiser, Highlander, RAV4 & 4-Runner  
2001 - On

UNIT PACKAGE: 15



**21206**  
(91560-S6A-003)  
Orange Nylon

Rear Liftgate Retainer  
**Overall Length: 19.5mm**  
Honda Fit 2009 - On

UNIT PACKAGE: 15



**18844**  
(67771-06010, 67771-32090)  
White Nylon

Trim Panel Retainer  
**Overall Length: 20mm**  
Cowl Side & Garnish  
Center Pillar Retainer  
Toyota Camry 1991 - On

UNIT PACKAGE: 10



**20879**  
(007-988-99-78, 007-988-34-78)  
Green Nylon

Door Trim Panel Retainer  
**Overall Length: 19.5mm**  
Mercedes-Benz 1996 - On

UNIT PACKAGE: 10



**21654**  
(Not Available from O.E.M.)  
White Nylon

Trim Panel Retainer  
**Overall Length: 20mm**  
Lincoln MTX 2012 - On

UNIT PACKAGE: 25



**22237**  
(Nissan: 01553-30001)  
White Nylon

Trim Panel Retainer  
**Overall Length: 20mm**  
Nissan Altima, Cube, GT-R, Murano,  
Pathfinder, Quest, Rogue, Sentra,  
Versa & Versa Note 2007 - On

UNIT PACKAGE: 25



**18950**  
(90467-10168)  
Black & White Nylon

Garnish Retainer  
**Overall Length: 20mm**  
Toyota Avalon & Camry 1991 - On

UNIT PACKAGE: 5

# TRIMMING SUNDRIES & FASTENERS

Refer to Retainer Specification Chart on pages 475-489



**21329**

Black Nylon  
(68061648-AA)

Tail Light Retainer  
**Overall Length: 20mm**  
Dodge Ram 2009 - On

UNIT PACKAGE: 15



**21976**

(Peugeot & Citroen: 6966.39)  
White Nylon

Trim Panel Retainer  
**Overall Length: 20mm**  
Peugeot & Citroen

UNIT PACKAGE: 15



**14728**

(67771-22020)  
Natural & Yellow Nylon

Door Panel Retainer  
**Overall Length: 20mm**  
Toyota

UNIT PACKAGE: 25



**21822**

(Peugeot & Citroen: 6822.LL)  
White Nylon

Door Panel Retainer  
**Overall Length: 20mm**  
Peugeot, Citroen & Toyota

UNIT PACKAGE: 25



**22009**

(Hyundai: 85506-4A000)  
White Nylon

Trim Panel &  
Window Garnish Retainer  
**Overall Length: 20mm**  
Hyundai Tucson & Kia Sorento 2003 - On

UNIT PACKAGE: 50



**22004**

(Hyundai: 82315-22000)  
White Nylon

Trim Panel Retainer  
**Overall Length: 20mm**  
Hyundai Accent 1999 - 95

UNIT PACKAGE: 50



**21289**

(84953-JA00A)  
Yellow Nylon

Trim Panel Retainer  
**Overall Length: 20mm**  
Nissan Altima 2010 - On

UNIT PACKAGE: 25



**14269**

(Isuzu: 8942264920;  
Mazda: 9927-40-825;  
Toyota: 67771-01010, 67771-12010)  
White Nylon

Door Panel Retainer  
**Overall Length: 20.5mm**  
Isuzu, Mazda & Toyota

UNIT PACKAGE: 25



**22157**

(Jaguar: C2D5807)  
Yellow Nylon

Rocker Moulding Retainer  
**Overall Length: 20mm**  
Jaguar XJ & XJ-L 2011 - On

UNIT PACKAGE: 15



**21138**

(51-43-7-001-491-2)  
White Nylon

Headliner Retainer  
**Overall Length: 20.5mm**  
Mini-Cooper 2005 - On

UNIT PACKAGE: 25



**20633**

(90467-10188)  
Turquoise Nylon

Trim Panel Retainer  
**Overall Length: 20mm**  
Toyota Sienna 2004 - On

UNIT PACKAGE: 25



**15709**

(67771-02030)  
Natural Nylon

Door Trim Retainer  
**Overall Length: 20.5mm**  
Toyota Corolla 1990 - On

UNIT PACKAGE: 50

**Sec. 19**

**TRIMMING SUNDRIES & FASTENERS**

Refer to Retainer Specification Chart on pages 475-489



**18876**

(Toyota: 90467-10161;  
GM: 94858299)  
White Nylon

Trim Board Retainer  
**Overall Length: 20.5mm**  
Sienna, Solara & Tercel 1990 - On  
Geo Prizm & Pontiac Vibe 1998 - On

UNIT PACKAGE: 25



**21640**

(84953-AU100)  
Black Nylon

Door Trim Panel Retainer with Sealer  
**Overall Length: 20.5mm**  
Infiniti FX35, FX45, G35 & G37  
2008 - 03

UNIT PACKAGE: 15



**21502**

(909130213)  
White Nylon

Door Trim Panel Retainer with Sealer  
**Overall Length: 20.5mm**  
Subaru Legacy & Outback 2010 - On

UNIT PACKAGE: 10



**15707**

(67771-03030)  
Gray Nylon

Door Trim Retainer  
**Overall Length: 20.5mm**  
Toyota Camry 1988 - On

UNIT PACKAGE: 50



**21118**

(MB374270, MB374271)  
White Nylon

Trim Panel Retainer  
**Overall Length: 20.5mm**  
Chrysler Laser, Stealth,  
Jeep Eagle & Talon and  
Mitsubishi Eclipse &  
Montero 1989 - On

UNIT PACKAGE: 15



**19898**

(67771-02030)  
Yellow Nylon

Trim Panel Retainer  
**Overall Length: 20.5mm**  
Toyota Corolla 1990 - On

UNIT PACKAGE: 50



**14270**

(67771-22010)  
Blue & Natural Nylon

Door Panel Retainer  
**Overall Length: 20.5mm**  
Toyota

UNIT PACKAGE: 25



**22267**

(GM: 11546850)  
White Nylon

Front Fender &  
Exterior Trim Moulding Retainer  
**Overall Length: 20.5mm**  
GMC Sierra 2015 - On

UNIT PACKAGE: 50



**14144**

(GM: 95005064;  
Toyota: 67771-01010)  
Black Nylon

Trim Panel Retainer  
**Overall Length: 20.5mm**  
Toyota & GM

UNIT PACKAGE: 25



**19910**

(90467-08179)  
Yellow Nylon

Garnish Retainer  
**Overall Length: 20.5mm**  
Toyota Tundra 1999 - On

UNIT PACKAGE: 25



**20669**

(01553-07111)  
Black Nylon

Trim Panel Retainer  
**Overall Length: 20.5mm**  
Nissan Altima and  
Infiniti G35 & Q45 1997 - On

UNIT PACKAGE: 25



**21087**

(90602-SAA-003)  
Orange Nylon

Cowl Vent & Radiator Support Retainer  
**Overall Length: 20.5mm**  
Honda Fit & CRV 2003 - On

UNIT PACKAGE: 15



# TRIMMING SUNDRIES & FASTENERS

**Sec. 19**

Refer to Retainer Specification Chart on pages 475-489



**19257**

(GM: 30006620;  
Toyota: 67771-12050;  
Suzuki: 09409-08320)  
Nylon

Cowl Vent Screen &  
Door Trim Panel Retainer  
**Overall Length: 20.5mm**

Chevrolet Geo, Metro & Tracker, Lexus and Toyota  
Celica, Corolla & Previa 1989 - On

UNIT PACKAGE: 15



**19108**

(67771-16080)  
Natural Nylon

Door Trim Panel & Back Panel  
Upper Garnish Retainer  
**Overall Length: 21mm**  
Toyota Truck 1988 - On

UNIT PACKAGE: 10



**20610**

(Honda: 91560-SM4-003)  
White Nylon

Door Trim Panel Retainer  
**Overall Length: 21mm**  
Honda Accord 1990 - On

UNIT PACKAGE: 25



**19386**

(6505292AA)  
Natural Nylon

Door Trim Panel Retainer  
**Overall Length: 21mm**  
Chrysler Vans 1998 - On

UNIT PACKAGE: 25



**20515**

(6505918-AA)  
Yellow & White Nylon

Trim Panel Retainer  
**Overall Length: 21mm**

Chrysler Caravan,  
Town & Country and Voyager  
Mini-Vans 2001 - On

UNIT PACKAGE: 25



**22315**

(Hyundai: 85849-3L000)  
Gray Nylon

Garnish & Interior Moulding Retainer  
**Overall Length: 21mm**  
Hyundai Azera, Sonata &  
Tuscon 2006 - On  
Kia Forte 2010 - On

UNIT PACKAGE: 50



**18874**

(67771-16120)  
Gray Nylon

Front & Rear Door  
Trim Panel Retainer  
**Overall Length: 21mm**  
Toyota Tercel 1994 - On

UNIT PACKAGE: 15



**19016**

(67771-12040)  
Dark Gray Nylon

Door Trim Panel Retainer  
**Overall Length: 21mm**  
Toyota Cressida 1992 - 88

UNIT PACKAGE: 15



**21788**

(BMW: 51-41-8-224-768,  
51-41-0-407-984)  
White Nylon

Door Panel Lining &  
Rear Window Retainer with Sealer  
**Overall Length: 21mm**  
BMW X Series 2006 - On  
Mini-Cooper 2002 - On

UNIT PACKAGE: 25



**21873**

(BMW: 51-43-7-001-491)  
White Nylon

Trim Panel Retainer  
**Overall Length: 21mm**  
Renault, Dacia & BMW

UNIT PACKAGE: 25



**22229**

(BMW: 51418224781;  
51410407983; 51430141025)  
Gray Nylon

Door Trim Panel Retainer with Sealer  
**Overall length: 21mm**  
BMW 1, 3, 4, 5, 6, X & Z Series 1992 - On

UNIT PACKAGE: 25



**21247**

(W709995-S300)  
Green Nylon

Lift Gate Trim Retainer  
**Overall Length: 21mm**  
Ford Flex 2009 - On

UNIT PACKAGE: 25

**Sec. 19**

**TRIMMING SUNDRIES & FASTENERS**

Refer to Retainer Specification Chart on pages 475-489



**22206**

(Subaru: 909130105)  
White Nylon

Front & Rear Door, Headliner, Interior Trim,  
Liftgate & Quarter Panel Retainer

**Overall Length: 21mm**

Subaru BRZ, Forester, Impreza, Legacy, Outback, B9  
Tribeca, WRX & XV Crosstrek 2002 - On

UNIT PACKAGE: 50



**22220**

(GM: 92138811)  
White Nylon

Front & Rear Door Sill and  
Rocker Panel Moulding Retainer

**Overall Length: 21.6mm**

Chevrolet Caprice & SS 2011 - On  
Pontiac G8 2009 - 2008

UNIT PACKAGE: 25



**22006**

(Hyundai: 82315-36000, 92552-36000)  
White Nylon

Trim Panel Retainer with Sealer

**Overall Length: 21mm**

Hyundai Accent & Elantra 2000 - 1995

UNIT PACKAGE: 25



**19210**

(67771-04040)  
Natural Nylon

Front Door Trim Panel Retainer

**Overall Length: 22mm**

Toyota Tacoma 1995 - On

UNIT PACKAGE: 50



**21059**

(90602-S5A-003)  
Blue Nylon

Cowl Vent Retainer

**Overall Length: 21mm**

Acura RSX and Honda Civic & CR-V  
2001 - On

UNIT PACKAGE: 15



**18294**

(91566-SP0-003)  
White Nylon

Trim Panel Retainer

**Overall Length: 22mm**

Honda 1990 - On

UNIT PACKAGE: 15



**21884**

(Peugeot & Citroen: 6990.50)  
White Nylon

Trim Panel Retainer

**Overall Length: 21.3mm**

Peugeot & Citroen

UNIT PACKAGE: 25



**19628**

(5012874-AA, 6505539-AA)  
White Nylon

Door Trim Panel Retainer

**Overall Length: 22mm**

Jeep Grand Cherokee 1999 - On

UNIT PACKAGE: 25



**18915**

(6504014)  
White Nylon

Door Trim Panel Retainer

**Overall Length: 21.5mm**

Chrysler Caravan Cirrus, Neon, Ram  
Truck, Stratus & Voyager 1995 - On

UNIT PACKAGE: 50



**21333**

(11561654)  
Blue Nylon

Cowl, Pillar, Trim Panel  
& Windshield Retainer

**Overall Length: 22mm**

GM 2006 - On

UNIT PACKAGE: 15



**17669**

(6502907, 6504452)  
Yellow Nylon

Trim Panel Retainer

**Overall Length: 21.5mm**

Jeep Grand Cherokee  
& Dodge Truck 1993 - On

UNIT PACKAGE: 50



**22288**

(Infiniti: 01553-10641)  
Green Nylon

Door & Interior Trim Panel Retainer

**Overall Length: 22mm**

Infiniti FX35, FX 37, FX50 & QX70  
2009 - On

UNIT PACKAGE: 25

# TRIMMING SUNDRIES & FASTENERS

## Sec. 19

Refer to Retainer Specification Chart on pages 475-489



**18862**  
(6503204)  
Green Nylon

Trim Panel Retainer  
**Overall Length: 23mm**  
Chrysler Cirrus & Stratus 1995 - On

UNIT PACKAGE: 50



**20428**  
(5028438-AA)  
Green & White Nylon

Door Trim Panel Retainer  
**Overall Length: 24.5mm**  
Chrysler Vans 2001 - On

UNIT PACKAGE: 25



**21250**  
(Not Available from O.E.M.)  
Black Nylon

Seat Back & Trim Panel Retainer  
**Overall Length: 23mm**  
Jeep Commander 2006 - On

UNIT PACKAGE: 25



**20190**  
(W708621-S300)  
Caramel & Natural Nylon

Trim Panel Retainer  
**Overall Length: 25mm**  
Ford Taurus & Sable  
2000 - On

UNIT PACKAGE: 25



**20765**  
(6507055-AA, 6507686-AA)  
Yellow Nylon

Door Panel Retainer  
**Overall Length: 23mm**  
Jeep Grand Cherokee  
2003 - On

UNIT PACKAGE: 50



**20949**  
(W711037-S300)  
Black & Blue Nylon

Door Trim Panel Retainer  
**Overall Length: 25mm**  
Ford Edge, Escape, Freestyle  
Mariner, Montego & 500 2005 - On

UNIT PACKAGE: 25



**22149**  
(Land Rover: LR027255)  
Blue Nylon

Wheel Arch Moulding Retainer  
**Overall Length: 23mm**  
Land Rover Evoque 2012 - 2004

UNIT PACKAGE: 15



**21131**  
(90602-SEP-A00)  
Black Nylon

Trim Panel Retainer  
**Overall Length: 25.5mm**  
Acura TL 2007 - On

UNIT PACKAGE: 15



**19129**  
(GM: 95008221;  
Toyota: 67771-30090;  
Chrysler & Mitsubishi: MB608104)  
Yellow Nylon

Door Trim Panel &  
Back Panel Lower Garnish Retainer  
**Overall Length: 23.5mm**  
Toyota Land Cruiser & 2WD Truck 1991 - On  
Geo Prism 1997 - 93

UNIT PACKAGE: 15



**20444**  
(15076791)  
White Nylon

Trim Panel Retainer  
**Overall Length: 26mm**  
GM Trucks: Rendezvous, S & T 2002 - On

UNIT PACKAGE: 15



**22031**  
(GM: 11569700)  
Gray Nylon

Trim Panel Retainer  
**Overall Length: 24mm**  
Cadillac SRX; Chevrolet Equinox &  
Tahoe and GMC Denali & Yukon 2010 - On

UNIT PACKAGE: 15

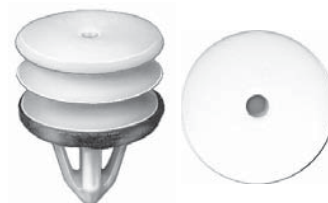

**20616**  
(GM: 11519031;  
Ford: W711521-S300)  
White Nylon

Door Panel Retainer  
with Sealer  
**Overall Length: 26mm**  
Hummer H2 2003 - On  
Lincoln 2007 - On

UNIT PACKAGE: 15

**Sec. 19**

**TRIMMING SUNDRIES & FASTENERS**

Refer to Retainer Specification Chart on pages 475-489



**20427**

(6505759-AA)  
Gray & White Nylon

Door Trim Panel Retainer  
**Overall Length: 26mm**  
Chrysler Vans 2001 - On

UNIT PACKAGE: 25



**20563**

(5023173-AA)  
White Nylon

Door Trim Panel Retainer  
**Overall Length: 30mm**  
Jeep Liberty 2002 - On

UNIT PACKAGE: 15



**21379**

(15931605)  
Black Nylon

Cowl Grille Retainer with Sealer  
**Overall Length: 26mm**  
Chevrolet Traverse 2010 - On

UNIT PACKAGE: 10



**22090**

(BMW: 51477117532)  
Brown Nylon

Scuff Plate Retainer with Sealer Top  
**Overall Length: 30mm**  
Fits into 10mm Hole  
BMW 1, 3, 5, 6 & X Series 2012 - 02

UNIT PACKAGE: 15



**21169**

(W713297-S300)  
White Nylon

Door Trim Panel Retainer with Sealer  
**Overall Length: 28mm**  
Ford Flex 2009

UNIT PACKAGE: 25



**17685**

(6502991)  
Yellow Nylon

Trim Panel &  
Tail Gate Retainer  
**Overall Length: 31.5mm**  
Jeep Cherokee 1993 - On

UNIT PACKAGE: 25



**21189**

(11519032)  
Black Nylon

Trim Panel Retainer  
**Overall Length: 28mm**  
Buick Lucerne & Rainier, Cadillac DTS,  
Escalade & SPX, Chevrolet Avalanche,  
Malibu, Silverado, Tahoe & Trailblazer,  
GMC Envoy, Sierra, Suburban & Yukon,  
Hummer H2, H3 & H3T, Oldsmobile  
Bravada and Pontiac G6 2002 - On

UNIT PACKAGE: 10

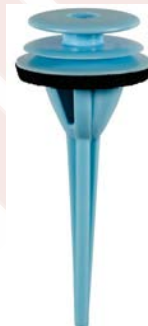

**22012**

(Hyundai: 87378-3N000)  
Blue Nylon

License Plate Panel  
Retainer with Sealer  
**Overall Length: 44.5mm**  
Hyundai Equus 2011 - On

UNIT PACKAGE: 25



**18930**

(22600612, 22651066)  
Yellow Nylon

Trim Panel Retainer  
**Overall Length: 28mm**  
GM 1996 - On

UNIT PACKAGE: 25



**19775**

(55350747AB)  
White Nylon

Door Trim Panel Retainer with Sealer  
Chrysler Mini-Vans 1999 - On

UNIT PACKAGE: 15



**22034**

(GM: 11562568)  
White Nylon

Windshield Garnish &  
Interior Trim Retainer  
**Overall Length: 29mm**  
Buick Enclave, Lucerne & Verano;  
Cadillac ATS, CTS, SRX & XTS;  
Chevrolet Cruze, Equinox & Traverse and  
GMC Acadia & Terrain 2008 - On

UNIT PACKAGE: 10



**19428**

(22646099)  
White Nylon

Trim Panel Retainer with Sealer  
Chevrolet Cavalier &  
Pontiac Sunfire 1995 - On

UNIT PACKAGE: 25

# TRIMMING SUNDRIES & FASTENERS

## Sec. 19

Refer to Retainer Specification Chart on pages 475-489



**19758**  
(25704141)  
Green Nylon

Trim Panel Retainer  
with Sealer  
Buick LeSabre &  
Pontiac Bonneville 2000 - On

UNIT PACKAGE: 10



**19804**  
(5023111AA)  
White Nylon

Trim Panel Retainer  
with Sealer  
Dodge Neon 2000 - On

UNIT PACKAGE: 15



**22250**  
(Jaguar: C2C14628)  
Black Nylon

Trim Panel Retainer  
With Sealer  
Jaguar 2015 - On

UNIT PACKAGE: 15



**20188**  
(003-988-41-78)  
White Nylon

Trim Panel Retainer  
Mercedes-Benz Body Styles  
107, 108, 109, 114, 115,  
123 & 124 1995 - 68

UNIT PACKAGE: 10



**21494**  
(VW: 171-807-249-A)  
Natural Nylon

Trim Panel Retainer  
VW Golf & Audi 1978 - On

UNIT PACKAGE: 25



**20735**  
(463-988-02-78)  
Black Nylon

Door Panel Retainer  
Mercedes-Benz  
G55 & G500  
2002 - On

UNIT PACKAGE: 25



**14363**  
(9927-40-821)  
Natural Nylon

Door Panel Retainer  
Mazda

UNIT PACKAGE: 25



**13179**  
(BMW: 51-41-8-172-050;  
VW: 481-867-197)  
Black Nylon

Trim Panel Retainer  
VW & BMW

UNIT PACKAGE: 50



**16778**  
(Mazda: 9927-40-822;  
Toyota: 62581-14020)  
Natural Nylon

Trim Panel Retainer  
Mazda & Toyota

UNIT PACKAGE: 25



**20252**  
(823-867-299)  
Black Nylon

Trim Panel Retainer  
VW Corrado, Eurovan, Jetta,  
Rabbit & Vanagon 1979 - On

UNIT PACKAGE: 25

**Sec. 19**

**TRIMMING SUNDRIES & FASTENERS**

Refer to Retainer Specification Chart on pages 475-489



**11349**  
(AMC: 4005099; GM: 796255;  
Chry: 6033862)  
Black Nylon

Door Panel Retainer  
American Motors 1976 - On  
GM 1988 - 81  
Jeep Wrangler 1991 - On

UNIT PACKAGE: 25



**13475**  
(Renault: 8934-201-681;  
VW: 175-867-299)  
White Nylon

Trim Panel Retainer  
AMC-Renault 1984 - On  
VW 1982 - On

UNIT PACKAGE: 50



**13945**  
(01553-S3500)  
White Nylon

Door Trim Panel Retainer  
Nissan Trucks

UNIT PACKAGE: 50



**16017**  
(363137)  
White Nylon

Trim Panel Retainer  
Chevrolet Truck & GMC 1976 - On

UNIT PACKAGE: 100

**15461**  
Same as 16017 except for unit package quantity

UNIT PACKAGE: 50



**11678**  
(Chry: 6003349; GM: 9685057;  
AMC: 4005470; VW: N98905101)  
White Nylon

Door Trim Panel Retainer  
Chrysler, GM, AMC & VW 1976 - On

UNIT PACKAGE: 25



**13453**  
(20480475)  
White Nylon

Rear Quarter Panel Retainer  
GM

UNIT PACKAGE: 50



**13461**  
(20451401)  
White Nylon

Retains Conduit to Sheet Metal in Doors  
GM

UNIT PACKAGE: 25



**11672**  
(387496-S)  
White Nylon

Trim Panel Retainer  
Ford 1976 - On

UNIT PACKAGE: 25



**15669**  
(10126901)  
White Nylon

Trim Panel Retainer  
GM 1987-On

UNIT PACKAGE: 50



**20253**  
(51-41-1-973-500)  
White Nylon

Trim Panel Retainer  
BMW Series 3, 5 & 7 1987 - On

UNIT PACKAGE: 50



**10621**  
(2064891, 9818648, 9883583)  
White Nylon

Door Trim Panel &  
Headliner Retainer  
GM 1971 - On

UNIT PACKAGE: 50

**16260**  
Same as 10621 except for unit package quantity

UNIT PACKAGE: 100



**11774**  
(9883583)  
White Nylon

Door Trim Panel Retainer  
GM 1971 - On

UNIT PACKAGE: 50

# TRIMMING SUNDRIES & FASTENERS

Refer to Retainer Specification Chart on pages 475-489



**12737**  
(12337920, 20374473)  
White Nylon

Door Panel Retainer  
Camaro & Firebird 1982-On  
GM Truck 1989-On

UNIT PACKAGE: 50

## 14524

Same as 12737 except for unit package quantity

UNIT PACKAGE: 25



**11796**  
(3065575)  
White Nylon

Door Trim Panel Retainer  
GM 1978-On

UNIT PACKAGE: 50

## 16261

Same as 11796 except for unit package quantity

UNIT PACKAGE: 100



**13992**  
(20429451)  
White Nylon

Door Trim Panel Retainer  
GM 1984-On

UNIT PACKAGE: 25



**11677**  
(GM: 20298365; Chry: 6013122)  
Natural Nylon

Trim Panel Retainer  
Chrysler 1976-On  
GM 1982-On

UNIT PACKAGE: 50



**17649**  
(15953247)  
White Nylon

Trim Panel Retainer  
GM C & K Trucks 1993-On

UNIT PACKAGE: 50



**20279**  
(25672428)  
White Nylon

Trim Panel Retainer  
with Sealer  
Buick LeSabre & Park Ave., Cadillac  
DeVille & Seville, Oldsmobile Aurora  
& Pontiac Bonneville 1998 - On

UNIT PACKAGE: 10



**15670**  
(15545202)  
White Nylon

Door Trim Panel Retainer  
GM Trucks 1988-On

UNIT PACKAGE: 50



**12992**  
(10073833, 15600382, 20421800)  
White Nylon

Door Trim Panel Retainer  
GM 1983 - On

UNIT PACKAGE: 25



**13946**  
(15588024, 15596301)  
Yellow Nylon

Side & Rear Door Trim Retainer  
GM Astro & Safari Mini-Vans 1985 - On

UNIT PACKAGE: 25



**17092**  
(20734005)  
Yellow Nylon

Door Trim Panel Retainer  
GM 1982 - On

UNIT PACKAGE: 50



**15970**  
(15607165, 15612948)  
White Nylon

Trim Panel Retainer  
GM Trucks 1976 - On

UNIT PACKAGE: 25

**Sec. 19**

**TRIMMING SUNDRIES & FASTENERS**

Refer to Retainer Specification Chart on pages 475-489



**18936**

(N811006-S)  
Natural Nylon

Trim Panel Retainer  
Ford 1995-On

UNIT PACKAGE: 25



**14758**

(D9AB-74519B18-AA)  
White Nylon

Roof Liner  
Moulding Retainer  
Ford Taurus &  
Sable 1986-On

UNIT PACKAGE: 25



**20341**

(3B0-868-243)  
Black Nylon

Door Trim Panel Retainer  
VW Beetle, Golf, Jetta &  
Passat 1998 - On

UNIT PACKAGE: 25



**21398**

(VW: 6K0-868-243-C)  
Black Nylon

Trim Panel Retainer  
Audi and  
Volkswagen Touareg 2004 - On

UNIT PACKAGE: 25



**21144**

(VW: 8E0-868-243)  
Black Nylon

Interior Trim Panel  
Retainer with Sealer  
Audi A4 & S4, Avant, Sedan Wagon,  
Cabriolet & Quattro 2005 - On

UNIT PACKAGE: 25



**21894**

(VW: 5X0-867-299)  
Black Nylon

Trim Panel Retainer  
VW, Audi, SEAT & Skoda

UNIT PACKAGE: 15



**21708**

(VW: 7L6-868-243)  
Black Nylon

Door Trim Panel  
Audi A5, A6, A7, S5, S6  
& S7 And VW Beetle,  
Cabrio, Golf, Gti, Jetta,  
Passat & Touareg 2004 - On

UNIT PACKAGE: 15



**21393**

(VW: 1H0-868-243)  
Blue & Black Nylon

Trim Retainer  
Audi and Volkswagen Cabrio  
Golf & Jetta 1999 - 1993

UNIT PACKAGE: 25



**21415**

(VW: 1H0-868-243-B)  
Tan and White Nylon

Adjustable Door  
Trim Panel Retainer  
VW Golf 2002 - 1993

UNIT PACKAGE: 25



**21997**

(VW: 6N0-868-243A)  
Black & White Nylon

Trim Panel Retainer  
VW, Audi, SEAT & Skoda

UNIT PACKAGE: 10



**22091**

(BMW: 51717066299)  
Black Nylon

Door Sill Cover Retainer  
T27 Drive  
BMW 5 & 6 Series 2011 - 02

UNIT PACKAGE: 15



# TRIMMING SUNDRIES & FASTENERS

Refer to Retainer Specification Chart on pages 475-489



**21854**  
(BMW: 07-14-7-122-913)  
Black Nylon

Rocker Trim  
Wheelhouse Retainer  
T10 Torx® Drive  
1, 3, 6 & X Series 2004 - On

UNIT PACKAGE: 15



**21851**  
(BMW: 51-47-8-116-564,  
51-47-2-499-935,  
51-47-8-183-031  
51-47-1-881-521)  
Black Nylon

Floor Mat Lock  
Retainer with Washer  
3, 5, 7 & 8 Series 1997 - On

UNIT PACKAGE: 10



**22245**  
(Land Rover: LR012844)  
Black Nylon

Body Liner Twist to Lock Retainer  
Land Rover Discovery,  
Range Rover &  
Range Rover Sport 2004 - On

UNIT PACKAGE: 15



**22092**  
(BMW: 51717066226)  
Black Nylon

Rocker Moulding &  
Door Sill Spacer Cover Retainer  
**Overall Length: 27mm**  
BMW 5 & 6 Series 2011 - 02

UNIT PACKAGE: 15



**22086**  
(BMW: 07147122912)  
Black Nylon

Rocker Panel &  
Wheelhouse Trim Retainer  
**Overall Length: 32mm**  
BMW 1, 3, 6 & X Series 2012 - 04

UNIT PACKAGE: 15



**19524**  
(N807875-S)  
Green Nylon

Door Trim Panel Retainer  
Lincoln Continental 1995 - On

UNIT PACKAGE: 25



**21023**  
(6503336)  
Black Nylon

Cowl Screen Retainer  
**Use with Auveco 18249**  
Dodge Ram 1994 - On

UNIT PACKAGE: 25



**20866**  
White Nylon

Double End Retainer  
Marine & Automotive Trim Shops

UNIT PACKAGE: 25



**17599**  
(15672328)  
Black Nylon

Radiator Grille Retainer  
GM S-10 & S-15 Pick-Ups 1991-On

UNIT PACKAGE: 25

**Auveco releases new items biweekly.  
Our Hot New Items bulletins can keep you  
up to date on all new product.**

**To receive these bulletins please  
contact customer service:  
mail@auveco.com or 1-800-354-9816**

**We also have all previous and current  
bulletins posted on www.auveco.com.**

**Sec. 19**

**RETAINER SPECIFICATION CHART**

Recommended Hole Size: .030" - .060" smaller than stem diameter

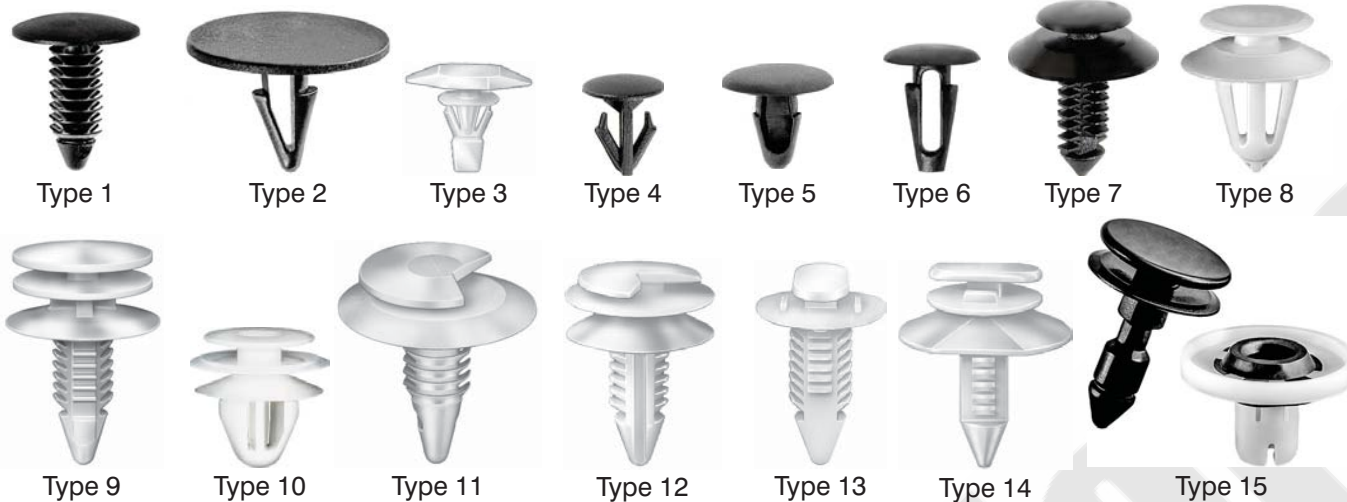

Auveco Part No.	Type	Color	Bottom Head Diameter	Top Head Diameter	Stem Diameter	Stem Length	Page No.
3620	5	Black	13/32"		9/64"	7/16"	442
3639	5	White	3/8"		7/32"	7/16"	442
5592	5	Black	1/2"		9/32"	5/8"	442
8853	3	Natural	3/16" x 1/2"		3/16"	5/8"	437
10332	1	Black	1-1/4"		5/16"	1/2"	428
10621	12	White	3/4"	11/16"	5/16"	1/2"	471
10744	3	Black	3/16" x 1/2"		3/16"	7/16"	437
10831	1	Black	11/16"		5/16"	5/8"	425
10832	1	Gray	11/16"		5/16"	5/8"	425
11120	1	Black	13/32"		5/32"	3/8"	416
11129	1	Black	3/8"		7/32"	3/8"	416
11130	1	Black	2"		5/16"	3/4"	434
11136	2	Black	1/2" x 1-1/2"		9/32"	5/8"	441
11146	1	Black	11/16"		5/16"	13/16"	425
11347	1	Black	3/4"		9/32"	1/2"	421
11349	11	Black	3/4"	19/32"	5/16"	11/16"	471
11350	1	White	1-7/32"		5/16"	1-1/16"	433
11351	1	Black	15/16"		5/16"	11/16"	429
11612	1	Black	7/16"		3/16"	5/8"	418
11671	7	Black	5/8"	1/2"	11/32"	1-1/8"	456
11672	11	White	15/16"	29/32"	5/16"	15/16"	471
11673	1	Natural	15/16"		5/16"	11/16"	429
11675	1	Black	5/8"		5/16"	11/16"	420
11677	13	Natural	9/16"	3/8" x 9/16"	11/32"	11/16"	472
11678	11	White	15/16"	29/32"	5/16"	11/16"	471
11679	1	Black	3/4"		9/32"	1/2"	421
11680	1	Black	7/16"		3/16"	5/8"	418
11721	1	Black	1/2"		9/32"	3/4"	417
11774	12	White	3/4"	11/16"	5/16"	1/2"	471
11796	12	White	7/8"	29/32"	5/16"	3/4"	472
11797	10	White	3/4"	1/2"	11/32"	9/16"	457
11842	1	Black	1-1/4"		5/16"	1-3/16"	433
12137	1	Black	1"		7/16"	13/16"	430
12565	7	Black	25/32"	1/2"	5/16"	5/8"	455
12571	1	Black	1"		5/16"	13/16"	429
12731	1	Black	25/32"		5/16"	15/16"	429
12737	12	White	3/4"	21/32"	5/16"	3/4"	472
12759	1	Black	1"		9/32"	1-7/16"	431
12766	1	Black	7/8"		7/16"	13/16"	430
12909	1	Black	1"		9/32"	1-1/16"	431
12992	14	White	3/4" x 7/8"	9/32" x 19/32"	5/16"	3/4"	472
12993	1	Black	1/2"		9/32"	11/16"	418
13179	11	Black	17mm	14mm	11mm	14mm	470
13198	1	Black	16mm		9mm	18mm	421
13453	11	White	15/16"	29/32"	5/16"	11/16"	471
13454	1	Black	21/32"		7/32"	15/32"	421
13461	11	White	15/16"	29/32"	5/16"	1-1/8"	471
13467	1	Black	1"		7/16"	1-7/16"	435

# RETAINER SPECIFICATION CHART

## Sec. 19

Recommended Hole Size: .030" - .060" smaller than stem diameter

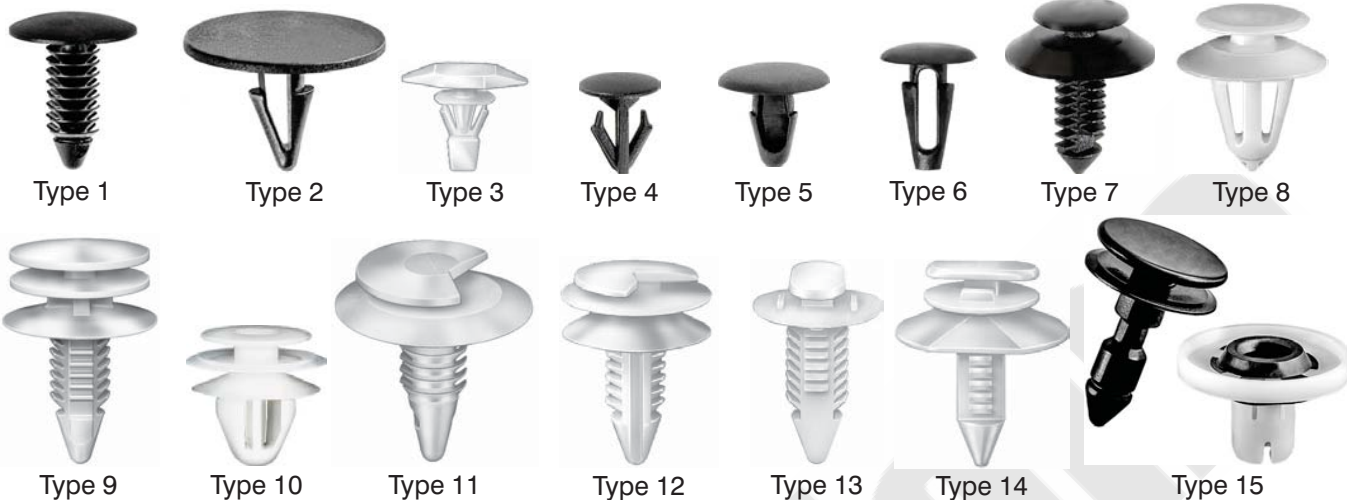

Auveco Part No.	Type	Color	Bottom Head Diameter	Top Head Diameter	Stem Diameter	Stem Length	Page No.
13470	7	White	3/4"	1/2"	5/16"	5/8"	455
13475	11	White	19mm	15mm	9mm	18mm	471
13757	Misc.	Black	2" Square		1/4"	9/16"	435
13945	11	White	19mm	15mm	9mm	18mm	471
13946	14	Yellow	3/4" x 7/8"	9/32" x 19/32"	5/16"	3/4"	472
13992	12	White	23/32"	23/32"	5/16"	5/8"	472
14006	1	Black	3/8"		9/32"	1/2"	417
14017	1	Black	1/2"		9/32"	5/8"	418
14021	1	Black	7/16"		7/32"	1/2"	416
14032	1	Black	3/4"		5/16"	1-1/4"	424
14035	1	Natural	19/32"		5/16"	2"	424
14036	1	Black	3/4"		5/16"	1-3/8"	424
14144	10	Black	18mm	13mm	9.5mm	14mm	465
14163	2	Black	1-3/4"		3/8"	3/4"	434
14269	10	White	18mm	13mm	9.5mm	14mm	464
14270	10	Blue/Natural	18mm	13mm	9.5mm	14mm	465
14282	6	Black	13mm		7.5mm	15mm	443
14289	1	Black	13mm		5mm	16mm	418
14291	5	Black	11mm		5.5mm	13mm	442
14299	3	White	7mm x 16mm		6.5mm	5mm	436
14319	4	Black	20mm		18mm	20mm	448
14323	4	Black	18mm		10mm	15mm	447
14328	3	White	7mm x 16mm		6mm	10mm	436
14347	4	Black	18mm		9mm	12mm	447
14348	6	Black	16mm		6.5mm	15mm	444
14349	5	Black	11mm		7mm	15mm	442
14352	6	Black	13mm		6mm	13mm	443
14353	4	Black	14mm		10mm	16mm	447
14355	6	Black	11mm		6mm	13mm	442
14356	4	Black	20mm		11mm	16mm	448
14363	11	White	17mm	15mm	10mm	14mm	470
14367	1	Black	12mm		5mm	12mm	415
14380	4	Black	18mm		12mm	18mm	448
14524	12	White	3/4"	21/32"	5/16"	3/4"	472
14709	1	Black	20mm		5.5mm	9mm	420
14720	4	Black	18mm		12.5mm	15mm	448
14723	4	Black	14mm		9mm	11mm	447
14728	10	Natural/Yellow	16mm	12.5mm	8.5mm	11mm	464
14736	5	Black	14mm		6mm	10mm	444
14737	6	Black	13mm		7mm	15mm	443
14738	6	Black	30mm		8mm	17mm	446
14757	1	Black	1/2"		1/4"	15/16"	422
14758	13	White	7/8" x 7/8"	3/8" x 7/8"	5/16"	19/32"	473
14857	1	Black	1/2"		9/32"	5/8"	418
14921	1	Black	10mm		6mm	12mm	416
14985	3	White	3/16" x 9/16"		1/8" x 3/8"	5/16"	436
15040	1	Black	3/4"		7/32"	11/16"	423
15050	1	Black	15mm		5.5mm	19mm	420

**Sec. 19**

**RETAINER SPECIFICATION CHART**

Recommended Hole Size: .030" - .060" smaller than stem diameter

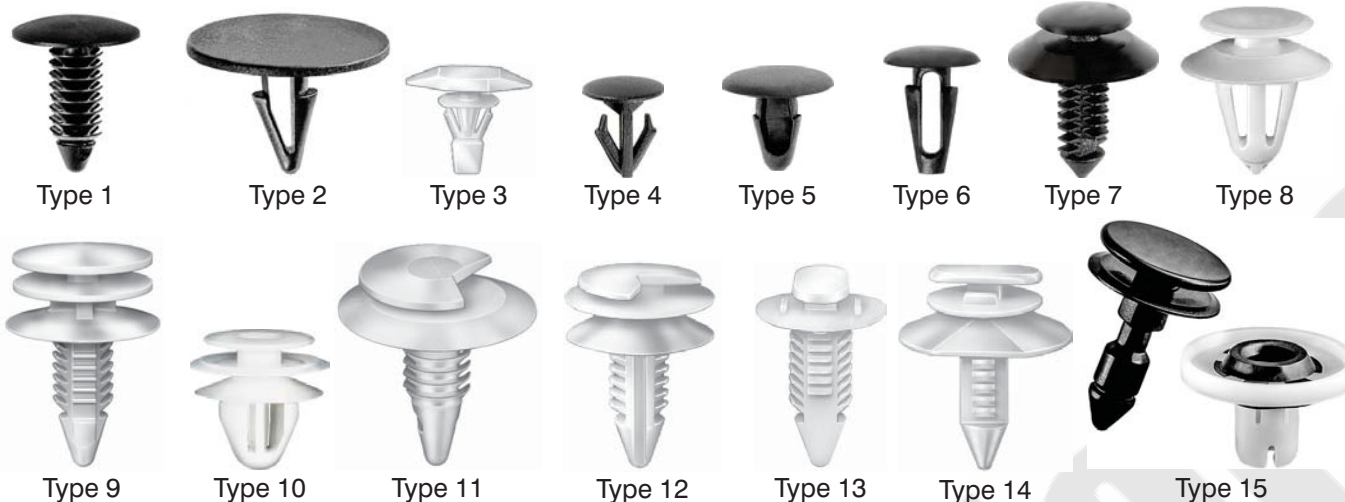

Auveco Part No.	Type	Color	Bottom Head Diameter	Top Head Diameter	Stem Diameter	Stem Length	Page No.
15367	1	Black	19/32"		7/32"	3/4"	420
15414	1	Black	11/16"		5/16"	13/16"	425
15456	1	Black	1-21/32"		5/16"	3/4"	433
15457	1	Black	1-3/8"		5/16"	15/16"	433
15461	11	White	3/4"	5/8"	5/16"	1"	471
15478	1	Black	22mm		11mm	28mm	430
15479	1	Black	26mm		8mm	38mm	431
15480	1	Black	25mm		8mm	20mm	429
15481	1	Black	25mm		7.5mm	20mm	428
15523	1	Black	1"		1/4" x 5/16"	1-1/8"	428
15543	1	Black	7/8"		5/16"	1-3/32"	426
15664	1	White	11/16"		5/16"	5/8"	425
15668	1	Black	1-3/4"		9/32"	1"	434
15669	11	White	15/16"	29/32"	5/16"	1-1/4"	471
15670	14	White	1/2"	1/4" x 29/64"	5/16"	3/4"	472
15707	10	Gray	17.5mm	13mm	10mm	14mm	465
15709	7	Natural	17.5mm	13mm	9.5mm	13mm	464
15970	14	White	9/16" x 11/16"	9/32" x 1/2"	5/16"	3/4"	472
15998	1	Black	30mm		6.5mm	9mm	432
16017	11	White	3/4"	5/8"	5/16"	1"	471
16132	1	Black	19mm		9mm	20mm	426
16259	1	Black	11/16"		5/16"	5/8"	425
16260	12	White	3/4"	11/16"	5/16"	1/2"	471
16261	12	White	7/8"	29/32"	5/16"	3/4"	472
16262	1	Black	7/8"		7/16"	13/16"	430
16263	1	Black	1"		7/16"	13/16"	430
16695	9	White	20mm	18mm	8mm	23mm	458
16775	1	Black	20mm		4.5mm	15mm	426
16776	1	Black	18mm		7.5mm	20mm	422
16777	4	Black	15mm		12mm	15mm	447
16778	11	Natural	18.5mm	14mm	11.5mm	14mm	470
16779	4	Black	18mm		11mm	15mm	448
16781	6	Black	15mm		8.5mm	20mm	444
16818	1	Black	3/4"		11/32"	7/8"	423
16863	1	Black	1-3/4"		5/16"	29/32"	434
16938	9	Black	8mm	14mm	8mm	15mm	457
17004	2	Black	1-5/16"		3/8"	3/4"	435
17072	Misc.	Black	1-1/2"		1-1/4"	5/16"	436
17075	9	White	3/4"	33/64"	5/16"	13/16"	457
17076	1	Black	18mm		7mm	23mm	427
17092	14	Yellow	13/16" x 29/32"	5/8"	5/16"	3/4"	472
17102	7	White	3/4"	1/2"	5/16"	1"	455
17124	7	Black	3/4"	1/2"	11/32"	3/4"	455
17205	4	Black	14mm		8mm	15mm	447
17215	1	Black	40mm		8mm	13mm	434
17218	7	Natural	20mm	13mm	8mm	18mm	455
17237	Misc.	Black	29.5mm		7mm	9mm	435
17339	3	Black	5mm x 15mm		4mm	12mm	440

# RETAINER SPECIFICATION CHART

## Sec. 19

Recommended Hole Size: .030" - .060" smaller than stem diameter

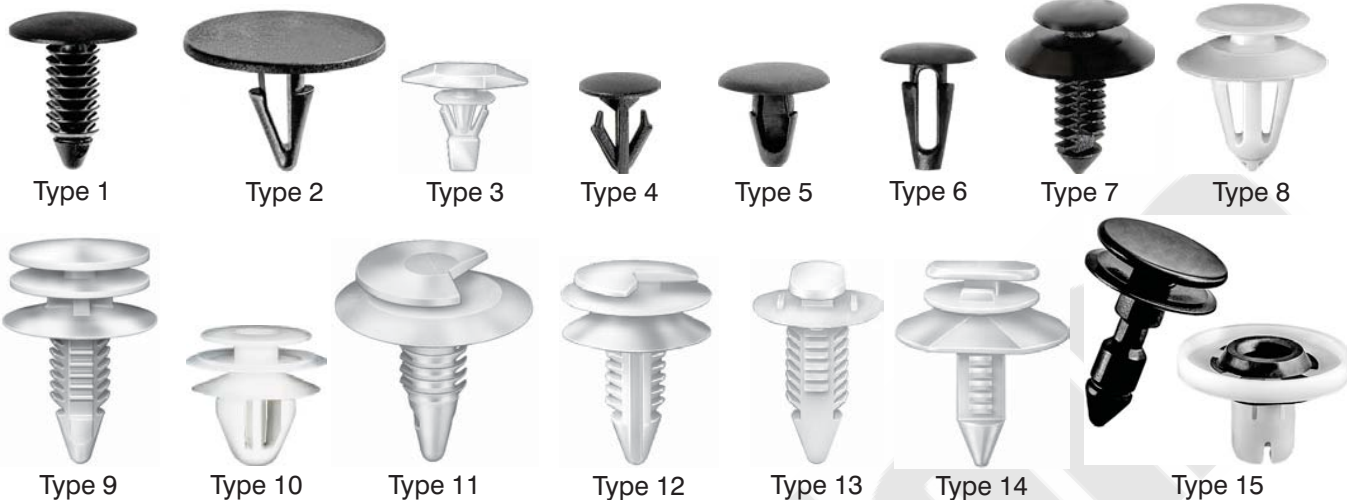

Auveco Part No.	Type	Color	Bottom Head Diameter	Top Head Diameter	Stem Diameter	Stem Length	Page No.
17381	1	Gray	32mm		8mm	20mm	433
17452	5	Black	13mm		5mm	15mm	443
17453	1	Gray	15mm		6.5mm	14mm	419
17599	Misc.	Black	3/4"		9/32" x 11/32"	11/16"	474
17612	1	Black	5/8"		3/8"	3/4"	426
17634	1	Black	12mm		6mm	16mm	417
17649	13	White	1/2" x 5/8"	9/32" x 1/2"	5/16"	7/8"	472
17664	1	Black	11/16"		5/16"	1-1/16"	425
17669	10	Yellow	23/32"	1/2"	5/16"	9/16"	467
17685	10	Yellow	18mm	13mm	8mm	25mm	469
17975	2	Black	1-3/16"		5/16"	1/2"	434
17990	6	Black	14mm x 15mm		7mm	19mm	444
17991	3	Black	8mm x 17mm		8mm	14mm	441
18033	3	White	1/4" x 21/32"		1/4"	15/32"	440
18114	4	Black	10mm		7.5mm	10mm	446
18157	6	Gray	13mm		5mm	16mm	444
18166	Misc.	Black	10mm		4mm	10mm	441
18174	1	Black	3/4"		5/16"	13/16"	423
18175	7	Natural	15/16"	1/2"	5/16"	15/16"	456
18248	2	Black	7/16"		11/64"	3/8"	442
18271	5	Black	14mm		6mm	15mm	444
18277	1	Gray	1"		5/16"	1-1/2"	432
18294	10	White	18mm	13mm	10.5mm	14mm	467
18297	6	Black	13mm		7.5mm	11mm	443
18298	1	Black	1/2"		5/16"	11/16"	417
18301	1	Black	3/4"		11/32"	1-3/16"	423
18302	1	Black	7/16"		7/32"	15/32"	416
18330	3	White	3/16" x 37/64"		11/64"	9/16"	441
18371	1	Gray	3/4"		5/16"	1-1/4"	424
18379	1	Black	23/32"		5/16"	7/8"	423
18389	1	Black	1/2"		9/32"	7/16"	416
18391	7	Natural	3/4"	1/2"	5/16"	1-5/32"	456
18458	4	Black	14mm		6mm	10mm	446
18508	3	Black	3/16" x 19/32"		15/32"	5/16"	441
18509	3	Natural	9/32" x 35/64"		9/32"	1/2"	437
18510	3	Natural	3/16" x 1/2"		13/64"	13/32"	436
18679	1	Gray	1"		7/16"	13/16"	430
18680	1	Black	1-1/32"		9/32"	1-3/32"	430
18682	1	Black	1/2"		1/4"	3/4"	419
18683	1	Black	23/64"		3/16"	7/16"	415
18684	1	Black	3/8"		5/32"	3/8"	415
18685	1	Black	31/32"		9/32"	3/4"	427
18688	1	Gray	1-1/32"		9/32"	1-3/32"	431
18692	3	Natural	5mm x 15mm		5mm Hole	10mm	439
18746	Misc.	Black	30mm		15mm x 18mm	10mm	435
18770	1	Black	3/8"		7/32"	5/8"	416
18771	1	Black	1"		19/64"	1-1/16"	430

**Sec. 19**

**RETAINER SPECIFICATION CHART**

Recommended Hole Size: .030" - .060" smaller than stem diameter

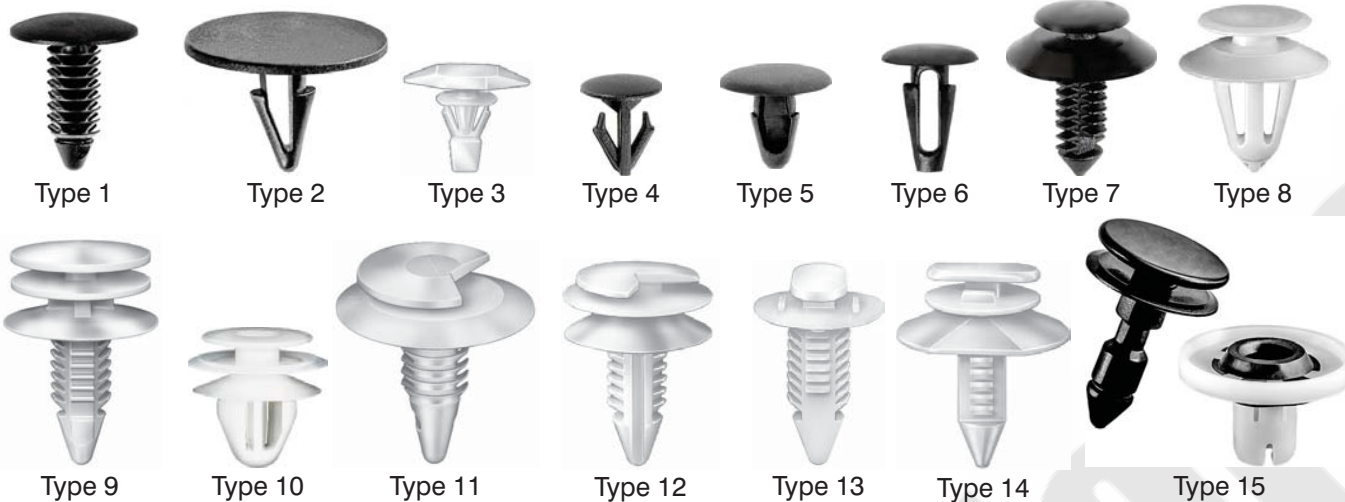

Auveco Part No.	Type	Color	Bottom Head Diameter	Top Head Diameter	Stem Diameter	Stem Length	Page No.
18815	1	Black	9/16"		5/16"	3/4"	419
18818	6	Natural	7mm x 16mm		5mm	12mm	441
18820	1	Black	3/4"		7/32"	1/2"	421
18824	10	White	15mm	13mm	9mm	9.5mm	458
18827	2	Black	25/32"		5/16"	7/16"	434
18842	6	Black	30mm		8.5mm	17mm	446
18844	10	White	18mm	13mm	10mm	13mm	463
18848	7	Yellow	3/4"	1/2"	3/8"	11/16"	455
18859	1	Black	19/32"		5/16"	1-3/8"	423
18861	8	White	18mm	13mm	8.5mm x 8.5mm	12mm	450
18862	10	Green	23/32"	19/32"	5/16"	5/8"	468
18874	10	Gray	18mm	13mm	9.5mm	15mm	466
18875	8	White	19mm	13mm	11mm	15mm	452
18876	10	White	18mm	13mm	9mm x 9mm	14mm	465
18877	3	Orange	5mm x 15mm		6mm	10mm	440
18878	6	Black	30mm		6mm	16mm	446
18897	1	Black	13/32"		13/64"	7/8"	417
18915	10	White	23/32"	1/2"	5/16"	9/16"	467
18930	10	Yellow	18mm	13mm	9mm	18mm	469
18936	14	White	19/32"	39/64" x 7/16"	5/16"	1/2"	473
18948	1	Black	7/16"		7/32"	11/16"	417
18950	10	Black/White	18mm	13mm	10mm	13mm	463
19014	Misc.	Natural	11mm x 12mm		9.5mm	16mm	442
19016	10	Dark Gray	18mm	13mm	9.5mm	15mm	466
19108	10	Natural	18mm	13mm	9.5mm	14mm	466
19109	10	Natural	15mm	13mm	9.5mm	11mm	460
19112	6	Black	30mm		8mm	16mm	446
19113	6	Black	25mm		8mm	12mm	445
19114	4	Black	12mm		8.5mm	9mm	446
19116	3	Natural	5mm x 15mm		6mm	10mm	440
19121	1	Gray	20mm		8mm	20mm	426
19123	Misc.	Black	17mm		7mm	12mm	444
19124	4	Black	16mm		10mm	10mm	447
19127	1	Black	1"		1/4"	25/32"	427
19129	10	Yellow	18mm	13mm	9.5mm	17mm	468
19145	10	Gray	17mm	13mm	9mm	12mm	461
19149	1	Black	3/8"		7/32"	5/8"	417
19155	2	Black	1-9/32"		3/8"	3/4"	435
19171	3	Green	5mm x 15mm		5mm Hole	10mm	439
19197	1	Gray	25mm		8mm	20mm	429
19203	10	Natural	18mm	13mm	11mm	11mm	461
19210	10	Natural	18mm	13mm	10mm	14mm	467
19213	7	Natural	3/4"	1/2"	11/32"	3/4"	455
19250	1	White	11/16"		5/16"	13/16"	425
19257	9	Maroon	18mm	13mm	9.5mm	14mm	466
19270	9	White	20mm	18mm	8mm	24mm	457
19275	9	White	20mm	18mm	8mm	13mm	457
19312	1	Black	16mm		5mm	13mm	419

# RETAINER SPECIFICATION CHART

## Sec. 19

Recommended Hole Size: .030" - .060" smaller than stem diameter

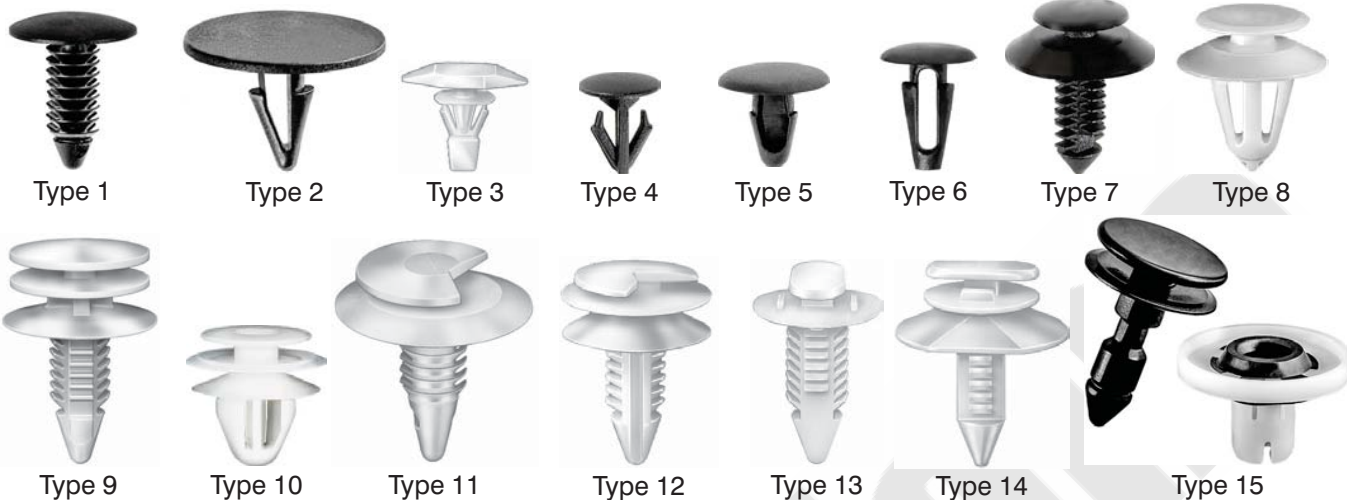

Auveco Part No.	Type	Color	Bottom Head Diameter	Top Head Diameter	Stem Diameter	Stem Length	Page No.
19320	8	White	16mm	12mm	9mm	11mm	449
19323	6	Black	26mm		10mm	8mm	445
19325	3	Brown	5mm x 13mm		7mm	6mm	438
19331	6	Black	14mm		7mm	11mm	444
19334	8	Natural	16mm	12mm	9mm	15mm	453
19338	1	Black	1-1/4"		5/16"	11/16"	433
19352	1	Gray	3/4"		5/16"	1-7/16"	425
19354	1	Tan	3/4"		5/16"	1-7/16"	425
19356	9	White	20mm	18mm	8mm	20mm	457
19368	3	Natural	5mm x 15mm		5mm Hole	9mm	438
19371	1	Blue	19/32"		9/32"	27/32"	426
19373	1	Light Gray	19/32"		9/32"	27/32"	426
19374	1	Tan	19/32"		9/32"	27/32"	426
19385	6	Gray	26mm		10mm	8mm	445
19386	10	Natural	20mm	15mm	9mm	15mm	466
19418	1	Black	13/32" x 1"		9/32"	9/16"	437
19425	3	Natural	9/32" x 1/2"		7/32"	21/32"	437
19428	Misc.	White	20mm	18mm	8mm	19mm	469
19449	1	Black	13/64" x 7/8"		7/32"	5/8"	437
19464	7	Natural	16mm	13mm	7mm	13mm	452
19466	10	White	17mm	13mm	9.5mm	12mm	460
19467	6	Black	13mm		6mm	10mm	443
19468	1	Black	28mm		6mm	10mm	432
19470	1	Black	16mm		4mm	21mm	422
19481	3	Blue	5mm x 15mm		6mm Hole	8mm	438
19483	3	Black	8mm x 18mm		7mm	15mm	441
19501	1	Tan	1-1/32"		9/32"	1-1/32"	431
19506	1	Black	16mm		5mm	16mm	420
19524	Misc.	Green	15mm		8mm	13mm	474
19527	10	Yellow	20mm	18mm	8mm	13mm	457
19541	1	Black	1"		9/32"	5/8"	428
19628	10	White	18mm	15mm	8.5mm	14mm	467
19643	1	Black	16mm		6mm	16mm	421
19655	2	Black	1-3/16"		3/8"	3/4"	434
19667	1	Black	3/4"		7/32"	11/16"	421
19673	1	Black	10mm x 15mm		5mm	10mm	417
19678	3	White	5mm x 15mm		6mm	10mm	437
19682	4	Black	11mm		7mm	8mm	446
19683	3	Black	6mm x 16mm		7mm	14mm	441
19684	3	Blue	7mm x 16mm		6mm Hole	12mm	440
19686	1	Black	12mm		5mm Sq.	6mm	415
19719	8	White	18mm	13mm	10mm	11mm	450
19720	3	Black/White	8mm x 17mm		7mm Hole	16mm	441
19724	3	White	6mm x 16mm			15mm	441
19728	3	Black	8mm x 17mm		7mm Hole	14mm	441
19729	4	Black	25mm		9mm	10mm	445
19731	10	White	17mm	13mm	9.5mm	13mm	461
19744	1	Black	16mm		6mm	27mm	422

**Sec. 19**

**RETAINER SPECIFICATION CHART**

Recommended Hole Size: .030" - .060" smaller than stem diameter

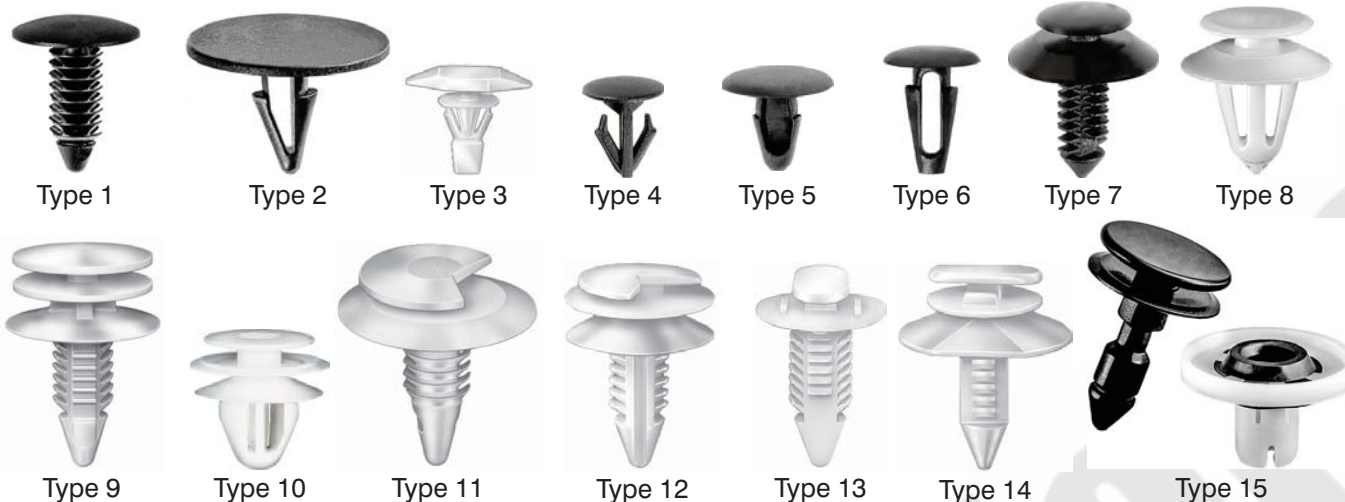

Auveco Part No.	Type	Color	Bottom Head Diameter	Top Head Diameter	Stem Diameter	Stem Length	Page No.
19746	Misc.	White	10.5mm		3.5mm, 5mm	15mm	415
19749	3	White	5mm x 15mm		6mm Hole	10mm	439
19758	Misc.	Green	19mm	19mm	8mm	20mm	470
19760	1	Black	25mm		8mm	24mm	428
19774	1	Black	13/32"		5/16"	1-5/16"	469
19775	Misc.	White	18mm	13mm	8mm	18mm	469
19790	1	Gray	11/16"		5/16"	13/16"	425
19802	10	White	16mm	12mm	8mm	24mm	455
19804	Misc.	White	22mm	16mm	9mm	15mm	470
19810	7	Black	13mm	12mm	8mm	19mm	455
19834	1	Black	3/4"		5/16"	1-1/16"	427
19836	1	Black	7/16"		7/32"	11/16"	418
19837	1	Black	3/4"		11/32"	13/16"	427
19842	Misc.	Black	18mm		11mm	22mm	423
19845	1	Med. Graphite	1"		5/16"	1-3/4"	432
19846	1	Black	1"		5/16"	1-3/4"	432
19850	3	Natural	5mm x 15mm		5mm	8mm	438
19855	1	Black	23/32"		15/64" x 9/32"	3/4"	425
19893	1	Black	5/8"		1/4"	3/4"	422
19898	10	Yellow	18mm	13mm	9.5mm	13mm	465
19910	10	Yellow	18mm	13mm	9mm x 9mm	14mm	465
20164	2	Black	30mm		8mm	12mm	434
20165	1	Black	10mm		6mm	12mm	416
20177	1	Gray	11/16"		5/16"	1-3/8"	423
20180	3	Black	6.5mm x 11mm		5.5mm	12mm	437
20181	3	White	6.5mm x 16mm		6mm	8mm	438
20182	3	White	6.5mm x 16mm		6mm	6mm	436
20184	1	Black	16mm		8mm	16mm	421
20188	11	White	18mm	13mm	8.5mm	11mm	470
20189	1	Black	1"		5/16"	5/8"	427
20190	Misc.	Carmel/White	20mm	13mm	8.5mm	16mm	468
20192	1	Black	11/16"		5/16"	1-3/4"	424
20252	11	Black	18mm	14mm	9mm	14mm	470
20253	12	White	18mm	14mm	9mm	15mm	471
20256	1	Black	15mm		4.5mm	14mm	419
20262	1	Black	1"		7/16"	9/16"	430
20274	7	White	23mm	13mm	6.5mm	20mm	455
20279	Misc.	White	13/16" x 1-7/16"	5/16" x 3/4"	5/16"	7/8"	472
20281	1	Black	21mm		13mm	27mm	429
20311	1	Black	14mm		7mm	9mm	417
20316	1	Black	1"		5/16"	13/16"	430
20319	1	Black	25mm		9mm	12mm	427
20334	1	Black	18mm		7.5mm	20mm	422
20338	9	White	25/32"	11/16"	5/16"	1-1/4"	458
20341	Misc.	Black	22mm		10.5mm	10mm	473
20344	1	Black	7/16"		7/32"	5/16"	416



# RETAINER SPECIFICATION CHART

## Sec. 19

Recommended Hole Size: .030" - .060" smaller than stem diameter

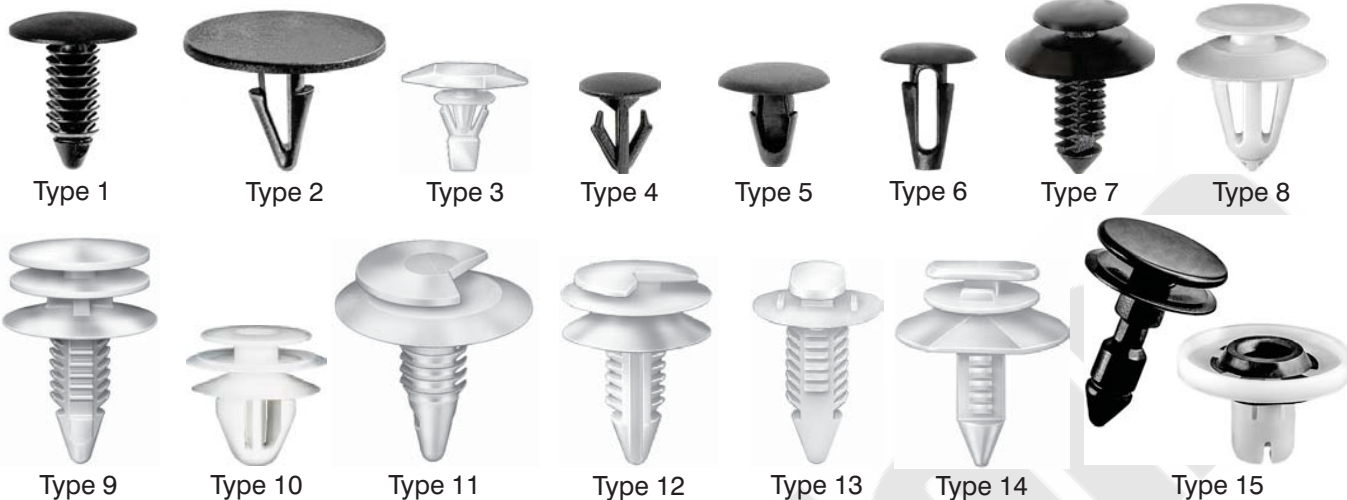

Auveco Part No.	Type	Color	Bottom Head Diameter	Top Head Diameter	Stem Diameter	Stem Length	Page No.
20345	1	Gray	1"		1/4" x 5/16"	1-1/8"	431
20360	1	Black	15/16"		3/8"	3/4"	427
20362	1	Black	25mm		13mm	15mm	430
20366	1	Black	22mm		7.5mm	35mm	424
20381	6	Black	16mm		7mm	16mm	444
20399	1	Black	3/4"		7/32"	15/32"	421
20411	10	Black	14.5mm	13mm	9.5mm	12mm	461
20427	10	Gray/White	20mm	15mm	9mm	18mm	469
20428	10	Green/White	20mm	15mm	9mm	18mm	468
20437	10	White	18mm	13mm	8.5mm x 8.5mm	15mm	463
20443	3	Black	5mm x 15mm		7mm	10mm	439
20444	10	White	19mm	20mm	11mm	17mm	468
20473	8	White	18mm	13mm	11mm	14mm	452
20515	10	Yellow/White	20mm	15mm	9mm	14mm	466
20528	1	Black	9mm		6mm	14mm	416
20531	1	Black	21mm		7.5mm	25mm	423
20541	1	Tan	35mm		7.5mm	20mm	433
20543	4	Black	26mm		12mm	14mm	448
20558	10	White	15mm	13mm	8.5mm x 9.5mm	11mm	459
20559	10	Blue	18mm	13mm	9mm x 9mm	11mm	459
20563	10	White	22mm	16mm	9mm	15mm	469
20571	8	White	18mm	13mm	9mm	9mm	449
20575	10	Yellow/White	18mm	13mm	10mm	13mm	463
20576	8	Yellow	14mm x 18mm	10mm x 13mm	8.5mm x 8.5mm	9mm	449
20609	1	Black	30mm		15mm x 20mm	14mm	435
20610	10	White	16mm	13mm	9mm	15mm	466
20611	8	Blue	16mm	12mm	3mm	7mm	449
20615	1	Black	35mm		8mm	20mm	433
20616	10	White	18.5mm	19.5mm	11mm	17mm	468
20624	1	Black	18mm		7.5mm	33mm	423
20625	1	Tan	25mm		8mm	29mm	431
20633	10	Turquoise	18mm	13mm	8.5mm x 9mm	14mm	464
20634	7	White	16mm	13mm	7mm	26mm	456
20642	8	Gray	16mm	13mm	9mm	13mm	449
20668	10	White	18mm	13mm	9mm	14mm	463
20669	10	Black	18mm	13mm	9mm	15mm	465
20670	10	Gray	18mm	13mm	8.5mm	12mm	459
20671	5	Black	20mm		9.5mm	15mm	445
20672	7	White	16mm	13mm	4mm	13mm	452
20735	11	Black	18mm	11.5mm	9mm	14mm	470
20760	3	Natural	5mm x 15mm		8mm	7mm	438
20761	1	Black	18mm		8.5mm	32mm	424
20765	10	Yellow	18mm	15mm	10mm	15mm	468
20770	4	Yellow	10mm		9mm	14.5mm	446
20814	9	White	25/32"	11/16"	5/16"	13/16"	458
20829	7	Black	18mm	14mm	8mm	15mm	454
20831	3	Blue	5mm x 14mm		6.5mm	10mm	439
20866	Misc.	White	1/2"		11/32"	7/16" & 7/8"	474

**Sec. 19**

**RETAINER SPECIFICATION CHART**

Recommended Hole Size: .030" - .060" smaller than stem diameter

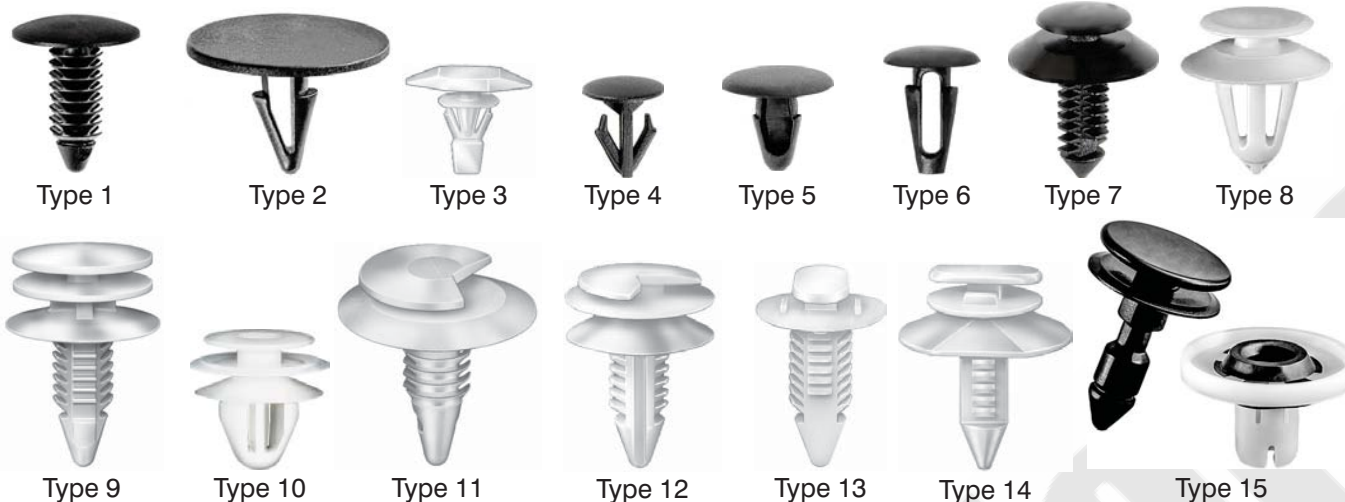

Auveco Part No.	Type	Color	Bottom Head Diameter	Top Head Diameter	Stem Diameter	Stem Length	Page No.	
20874	1	Black	25mm		7mm	23mm	431	
20878	1	Black	19mm		7.5mm	16mm	426	
20879	10	Green	17mm	13mm	9mm	14mm	463	
20881	8	White	16mm	13mm	8mm	13mm	450	
20882	6	Black	20mm		7mm	15mm	445	
20893	1	Black	12.5mm		7.5mm	15mm	417	
20926	1	Black	18mm		7.5mm	44mm	424	
20932	8	White	18mm	14mm	12mm	14mm	452	
20944	7	Green	25mm	18mm	8mm	24mm	456	
20949	10	Black & Blue	16mm	13mm	8mm	12mm	468	
20959	10	Blue	15mm	13mm	9.5mm	13mm	462	
20983	10	White	18mm	13mm	9mm	13mm	460	
20995	15	White	19.5mm	19mm		22mm	456	
			Grommet Flange: 24mm; Grommet Stem Length: 12mm; Fits into 9mm Hole					
20996	15	Yellow	19.5mm	19mm		22mm	456	
			Grommet Flange: 24mm; Grommet Stem Length: 12mm; Fits into 9mm Hole					
20998	15	Black & White	19.5mm	19mm		22mm	457	
			Grommet Flange: 24mm; Grommet Stem Length: 12mm; Fits into 9mm Hole					
20999	15	Green & Yellow	19.5mm	19mm		22mm	457	
			Grommet Flange: 24mm; Grommet Stem Length: 12mm; Fits into 9mm Hole					
21012	8	Black	18mm	13mm	9.5mm	14mm	452	
21023	Misc.	Black	9/16"		19/64"	13/32"	474	
21026	1	Black	20mm		8.5mm	20mm	426	
21059	10	Blue	18mm	12mm x 13mm	8.5mm x 8.5mm	14mm	467	
21070	10	White	16mm	13mm	9.5mm	10mm	460	
21087	10	Orange	18mm	12mm	9.7mm	14mm	465	
21088	8	White	17mm	13mm	9.5mm	14mm	452	
21090	1	Black	1"		11/32"	3/4"	428	
21091	8	Black	25mm	13mm	10.5mm	14mm	455	
21102	10	White	18mm	13mm	8.5mm	14mm	463	
21105	4	Black	20mm		14mm	10mm	448	
21107	7	White	16mm	13mm	4mm	13mm	451	
21118	10	White	18mm	13mm	10mm	14mm	465	
21125	1	Black	20mm x 36mm		17mm	25mm	437	
21131	10	Black	18mm	12mm	9.5mm	13mm	468	
21137	10	Black	15mm	13mm	10mm	8mm	458	
21138	10	White	18mm	14mm	9mm	14mm	464	
21139	10	White	18mm	12mm	9.5mm	11mm	460	
21143	1	Black	8.5mm x 14mm		5mm x 7.5mm	14mm	437	
21144	Misc.	Black	27mm	21.5mm	11mm	19mm	473	
21149	10	White	15mm	13mm	9.5mm	11mm	459	
21169	10	White	22mm	16mm	11mm	17mm	469	
21188	10	Pink	18mm	15mm	10mm	12mm	459	
21189	10	Black	19mm	20mm	11mm	16mm	469	
21199	1	Black	18mm		7.5mm	20mm	420	
21206	10	Orange	18mm	13mm	8.5mm	14mm	463	
21208	10	Gray	18mm	13mm	9mm	12mm	461	
21211	4	Black	24mm		9mm	12mm	434	

# RETAINER SPECIFICATION CHART

## Sec. 19

Recommended Hole Size: .030" - .060" smaller than stem diameter

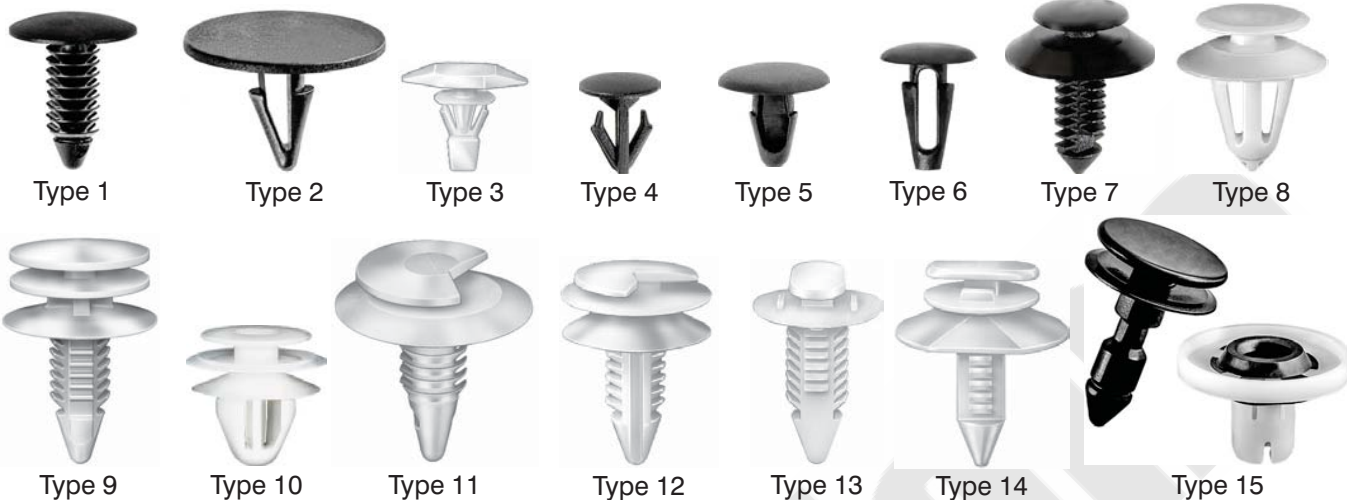

Auveco Part No.	Type	Color	Bottom Head Diameter	Top Head Diameter	Stem Diameter	Stem Length	Page No.
21226	8	Black	18mm	13mm	9mm	10mm	452
21227	1	Tan	45mm		9.5mm	20mm	434
21228	1	Tan	25mm		8.5mm	37mm	432
21229	6	Black	6.4mm x 16mm		3.5mm x 6mm	10mm	439
21240	10	Green	18mm	14mm	9mm	10mm	460
21241	1	Black	26mm		7.5mm	28mm	431
21247	10	Green	18mm	15mm	12mm	14mm	466
21248	1	Tan	25mm		7.5mm	22mm	428
21250	10	Black	16mm	13mm	11mm	14mm	468
21253	1	Gray	20mm		6mm	15mm	422
21254	1	Black	20mm		8mm	8mm	448
21257	1	Black	23mm		8mm	20mm	426
21287	1	Opal Gray	25mm		8mm	58mm	432
21288	1	Black	28mm		6mm	10mm	432
21289	10	Yellow	18mm	12.5mm	9.5mm	14mm	464
21295	6	Black	10mm		6mm	8mm	442
21296	6	Black	13mm		7mm	10mm	443
21301	1	Black	25mm		5.8mm	25.5mm	428
21303	1	Black	18mm		7mm x 7mm	13mm	419
21307	4	Black	9mm		5.5mm	7mm	446
21313	1	Black	31mm		7.6mm	13mm	433
21329	10	Black	18mm	15mm	9mm	13mm	464
21332	1	Tan	20mm		6mm	15mm	422
21333	10	Blue	18mm	13mm	10mm	14mm	467
21334	3	White	5mm x 15mm		8mm	8mm	438
21338	1	Black	25.4mm		8mm	27mm	428
21346	7	White	12mm x 16mm	15mm	5mm	34mm	456
21349	1	Gray	18mm		8mm	16mm	420
21350	1	Tan	18mm		8mm	16mm	420
21360	10	White	16mm	13mm	10mm	12mm	463
21364	8	Green	17mm	15mm	9mm	14mm	453
21365	8	Blue	17mm	13mm	9mm	13mm	450
21379	10	Black	18.5mm	19.5mm	11mm	16mm	469
21380	1	Black	28mm		8mm	17mm	432
21381	1	Black	5mm x 13mm		8mm	11mm	437
21382	1	Black	6mm x 16mm		8mm	14mm	436
21383	7	White	19mm	19mm	7mm	22mm	456
21385	1	Light Gray	33mm		8mm	41mm	433
21386	1	Tan	33mm		8mm	41mm	433
21392	1	Black	23mm		6.5mm	16mm	426
21393	Misc.	Green & Black	19mm	28mm	9mm	9mm	473
21398	Misc.	Black	18mm	22mm	9mm	11mm	473
21410	10	White	18mm	13mm x 18mm	10.7mm	12mm	459
21412	8	Gray	18.5mm	14mm	12mm	13mm	454
21414	10	White	18mm	13mm	9mm	13mm	463
21415	Misc.	Tan & White	28.5mm		9.5mm	11mm	473
21421	1	Black	30mm		7.7mm	13mm	432
21443	1	Black	30mm		7.8mm	15mm	432

**Sec. 19**

**RETAINER SPECIFICATION CHART**

Recommended Hole Size: .030" - .060" smaller than stem diameter

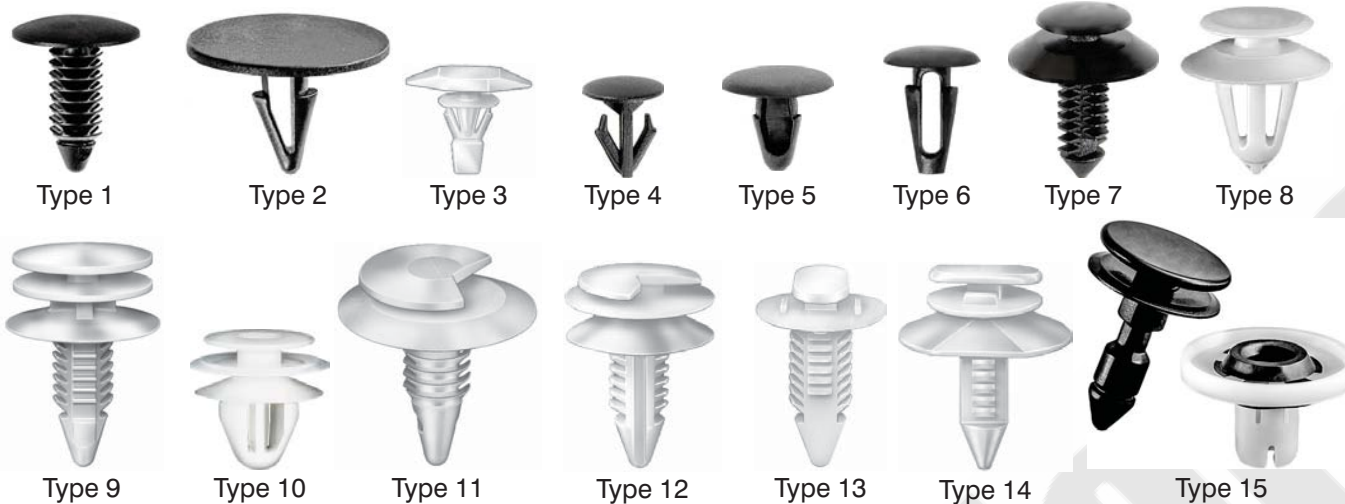

Auveco Part No.	Type	Color	Bottom Head Diameter	Top Head Diameter	Stem Diameter	Stem Length	Page No.
21450	8	Black	18mm	13.5mm	9mm	14mm	451
21458	1	Black	10mm		5.5mm	7mm	415
21488	8	Gray	17mm	13mm	9mm	14mm	450
21489	8	Yellow	17mm	15mm	9mm	14mm	453
21494	11	Natural	18mm	12mm	9.5mm	12mm	470
21495	8	Blue	18mm	13mm	9mm	14mm	451
21496	8	White	18mm	12mm	10mm	12mm	450
21497	Misc.	Black	6mm x 15mm		7.5mm	17mm	447
21502	10	White	15mm	13mm	9.5mm	14mm	465
21509	Misc.	White	18mm	12mm	10mm	16mm	449
21516	7	White	18mm	12mm	10mm	20mm	456
21519	1	Black	12mm		6mm	15mm	417
21520	4	Black	14mm		6.5mm	10mm	446
21532	7	White	12mm	13mm	8mm	25mm	456
21535	15	White	19.5mm	19.5mm		26mm	457
Grommet Flange: 24mm; Grommet Stem Length: 12mm; Fits into 9mm Hole							
21536	15	Yellow	19.5mm	19.5mm		26mm	457
Grommet Flange: 24mm; Grommet Stem Length: 12mm; Fits into 9mm Hole							
21538	8	Charcoal	18mm	13mm	9.5mm	13mm	452
21548	1	Black	10mm		6mm	10mm	415
21551	Misc.	Black	12mm	9mm	7mm	13mm	449
21552	3	White	9mm	5mm x 15mm	6.5mm	4mm	438
21554	10	Black	15mm	13mm	9.5mm	11mm	461
21560	1	Black	20mm		7mm	15mm	422
21565	3	White	5mm x 14mm		7mm	8.5mm	438
21567	8	Gray	18mm	11mm x 15mm	9.7mm	12mm	451
21573	5	Black	9mm		6.5mm	13mm	442
21574	10	White	15mm	13mm	9.5mm	11mm	460
21584	10	White	18mm	13mm	9.3mm	10mm	458
21588	4	Black	8mm		5.3mm	7mm	446
21589	1	Black	18mm		7.7mm	15mm	419
21591	8	Black	17mm	11mm x 14mm	9.7mm	12mm	451
21626	6	Black	12mm		6.5mm	11mm	443
21627	1	Black	9mm		5.3mm	8mm	415
21630	1	Black	20mm		6mm	22mm	422
21633	3	White	6mm x 16mm		6.5mm	12mm	441
21634	Misc.	Black	16.5mm		9mm	13mm	445
21638	10	White	15mm	13mm	9.5mm	11mm	460
21640	10	Black	18mm	13mm	9mm	14mm	465
21643	6	Black	7mm x 13mm		7.5mm	13mm	444
21652	Misc.	Black	30mm		15mm x 21mm	14mm	435
21654	10	White	18mm	13mm	9.5mm	14mm	463
21661	1	Black	20mm		7mm	10mm	421
21673	1	Black	20mm		9mm	17mm	422
21675	10	Green	18mm	13mm	9.5mm	11mm	460
21676	10	Yellow	18mm	13mm	9.5mm	12mm	462
21678	8	Black	18.5mm	14mm	12mm	14mm	452
21679	1	Black	19mm		8mm	26mm	423

# RETAINER SPECIFICATION CHART

## Sec. 19

Recommended Hole Size: .030" - .060" smaller than stem diameter

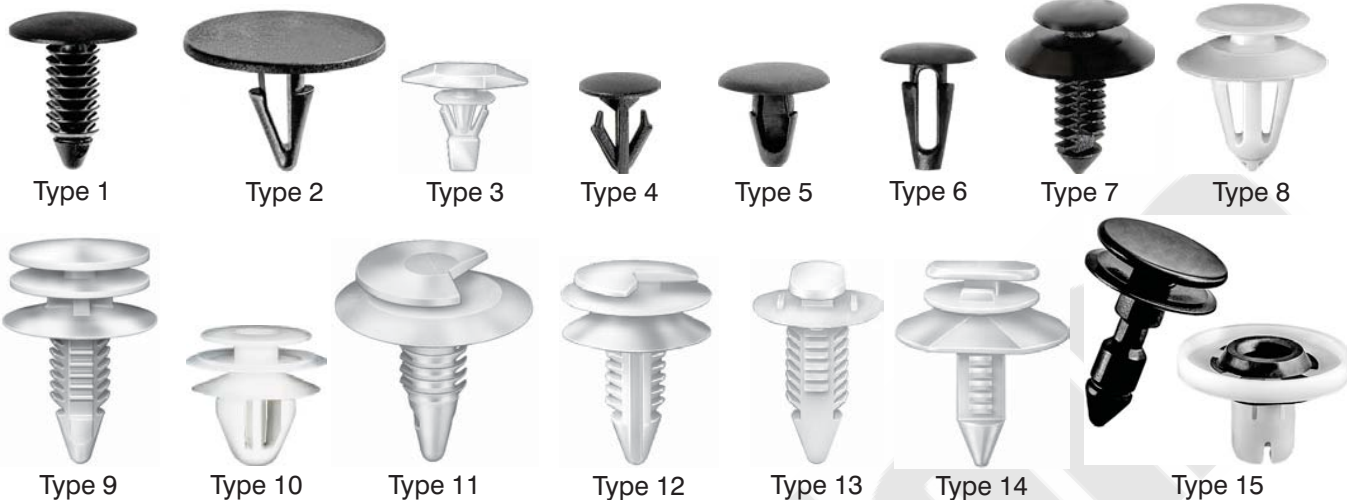

Auveco Part No.	Type	Color	Bottom Head Diameter	Top Head Diameter	Stem Diameter	Stem Length	Page No.
21686	10	Green	18mm	13mm x 16mm	9mm	9mm	459
21690	8	White	16mm	12mm	8mm x 8mm	14mm	453
21691	1	Black	24mm		6mm x 6mm	13mm	428
21692	6	Black	4.5mm x 11mm		6.5mm	9mm	443
21693	1	Black	16mm		4.7mm x 4.7mm	12mm	419
21694	3	Black	8mm	5mm x 14mm	6.3mm	5mm	438
21695	6	Black	4.5mm x 11mm		6.5mm	9mm	443
21696	7	Pale Yellow	16mm	12mm	4mm	6.5mm	449
21701	10	Black	18mm	13mm	10mm	11mm	459
21704	3	Green	9.5mm	5mm x 15mm	7mm	11mm	440
21705	3	Yellow	7.5mm	5mm x 15mm	6.5mm	7mm	440
21706	8	Black	20mm			14mm	486
21707	3	White	6.5mm		7mm	8.5mm	440
21708	Misc.	Black	22.5mm		9mm	12mm	473
21755	1	Black	15mm		6.5mm	14mm	419
21756	1	Clear	11/16"		5/16"	13/16"	425
21757	5	Black	18mm		9mm	15mm	445
21758	4	Black	14mm		7mm x 9mm	18mm	447
21770	1	Black	14mm		6mm	17mm	417
21773	3	Black	8mm	5mm x 11mm	6mm	7mm	440
21776	5	Black	25mm		9.5mm	16mm	435
21777	Misc.	Black	18mm	18mm	5mm x 8mm	18mm	455
21783	Misc.	Black	16mm	16mm	10mm	9mm	450
21785	Misc.	Yellow & Black	17mm	16mm		9mm	458
21786	Misc.	Black & White	17mm	13mm	8mm	9mm	458
21787	8	White	18mm	12mm	9.5mm	16mm	454
21788	10	White	18mm	14mm	9.5mm	14mm	466
21789	1	Black	23mm		11mm	16mm	430
21794	Misc.	White	18mm	15mm		12mm	456
21795	Misc.	White	18mm	13mm			454
21800	1	Black	13mm		7mm	15mm	418
21801	1	White	13mm		7mm	17mm	418
21802	1	Black	15mm		8mm	17mm	418
21803	1	Black	20mm		8mm	23mm	418
21804	1	Gray	20mm		8mm	23mm	418
21805	1	Black	35mm		10mm x 10.5mm	22mm	429
21806	1	Black	35mm		10.5mm	22mm	429
21808	1	White	10mm		8mm	15mm	416
21809	1	Black	21mm		7.5mm	23mm	428
21814	10	White	18mm	13mm	12mm	11mm	461
21819	8	Yellow	17.5mm	13mm	10mm	16mm	454
21822	10	White	18mm	13mm	8.5mm x 9mm	14mm	464
21851	Misc.	White	18.5mm			21mm	474
21853	8	Yellow	17.5mm	13mm	10.5mm	15mm	454
21854	1	Black	20mm		7mm	33mm	474
21855	1	Black	10.7mm		5.8mm	14mm	417
21868	1	Black	20mm		8mm	17mm	427

**Sec. 19**

**RETAINER SPECIFICATION CHART**

Recommended Hole Size: .030" - .060" smaller than stem diameter

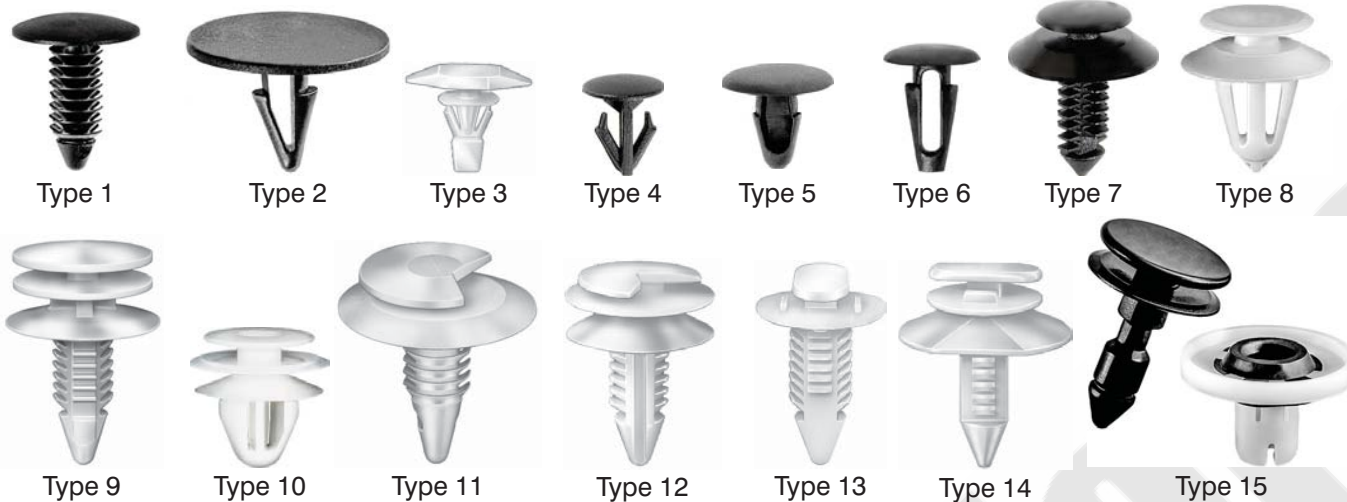

Auveco Part No.	Type	Color	Bottom Head Diameter	Top Head Diameter	Stem Diameter	Stem Length	Page No.
21870	4	Light Gray	18mm		11.5mm	13mm	447
21871	11	White	16.5mm	13mm	8.7mm	11mm	449
21873	10	White	18mm	14mm	9.5mm	14mm	466
21877	1	Black	19.5mm		7mm	13mm	419
21878	1	Black	14mm		7.5mm x 8mm	16mm	419
21879	4	Black	20mm		8mm	10mm	446
21880	4	Black	12mm		7mm	10mm	446
21884	10	White	18mm	11mm	8mm	13mm	467
21891	4	Black	20mm		11mm	7mm	434
21893	7	White	13mm	17mm	12mm	13mm	454
21894	10	Black	22mm	22mm	9.3mm	14mm	473
21895	10	Blue	18mm	13mm	12mm	12mm	462
21896	8	Gray	18mm	13.3mm	9.3mm	13mm	450
21900	6	Black	24mm		7mm	10mm	427
21905	1	Gray	21mm		7.5mm	19mm	427
21906	1	Black	30mm		8mm	18mm	427
21907	1	Gray	30mm		8mm	18mm	429
21908	6	Black	18mm		11mm	12mm	447
21909	6	Gray	18mm		11.3mm	12mm	447
21910	1	Black	16mm		9mm	20mm	419
21911	1	Gray	16mm		9mm	20mm	420
21912	1	Black	16mm		9mm	20mm	420
21913	1	Dark Gray	16mm		12mm	19mm	420
21914	1	Black	40mm		10.5mm	26mm	429
21916	9	Yellow	18mm	12.3mm	12mm	13mm	462
21917	9	Yellow	18mm	12.3mm	12mm	13mm	462
21918	5	Black	7mm x 12mm		8mm	9mm	442
21919	5	Black	7mm x 12mm		7mm	9mm	441
21920	4	Black	9mm x 18mm		8.5mm	10mm	442
21936	1	Black	11.5mm		5.5mm	12mm	416
21937	1	Black	21mm		7.7mm	16mm	421
21938	1	Black	18mm		7mm	17mm	420
21939	1	Tan	21mm		7.7mm	16mm	421
21940	1	Black	18mm		7.3mm	16mm	420
21941	1	Light Gray	21mm		7.7mm	16mm	421
21942	5	Black	9.3mm		6.5mm	13mm	421
21943	5	Gray	12mm		7.5mm	13mm	442
21944	10	Green/White	18mm	12.5mm	10.5mm	12mm	462
21947	1	Black	16mm		5.5mm	26mm	422
21949	3	Black	5mm x 12mm		7mm	10mm	440
21974	10	White	17mm	14mm	8.5mm	11mm	462
21975	11	White	17mm	14mm	9mm	10mm	449
21976	10	White	16.5mm	16mm	8.7mm	13mm	464
21977	7	White	18mm	13mm	11.5mm	12mm	450
21978	12	White	17mm	14mm	9mm	10mm	462
21980	3	Yellow	5mm x 13mm		5.7mm	5mm	439
21981	6	Black	5.5mm x 17mm		5mm	7mm	436
21982	6	Black	5mm x 13mm		5mm	9mm	436

# RETAINER SPECIFICATION CHART

Recommended Hole Size: .030" - .060" smaller than stem diameter

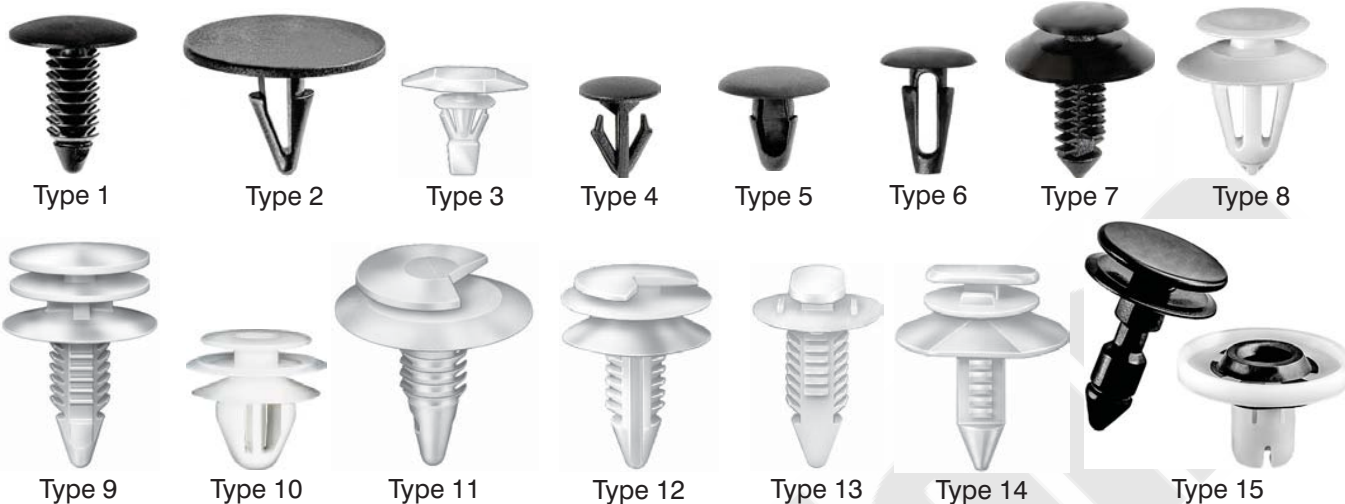

Auveco Part No.	Type	Color	Bottom Head Diameter	Top Head Diameter	Stem Diameter	Stem Length	Page No.
21984	1	Black	10mm		6mm	9mm	415
21991	8	Black	14mm	14mm	10mm	10mm	449
21995	8	White	19mm	17mm	12mm	10mm	454
21996	8	Yellow/White	19mm	17mm	12mm	10mm	454
21997	7	Black/White	28mm	19mm	10mm	12mm	473
21998	9	Yellow/White	17mm	13mm		9mm	461
22001	6	Black	9mm x 13mm		7.5mm	10mm	444
22003	10	White	18mm	13mm	11mm	13mm	462
22004	10	White	18mm	13mm	9mm	15mm	464
22005	10	White	18mm	15mm	10.7mm	12mm	462
22006	10	White	18.5mm	13mm	10.3mm	15mm	467
22008	10	Black	16mm	14mm	10.3mm	10mm	458
22009	10	White	15mm	13mm	9.6mm	13mm	464
22012	10	Blue	18mm	15mm	10.5mm	39mm	469
22031	10	Gray	18mm	16.5mm	10mm	15mm	468
22034	9	White	20mm	19mm	9mm	19mm	469
22046	4	Black	9.3mm x 14.5mm		7mm	16mm	447
22048	10	White	18mm	13mm	9mm x 9.5mm	11mm	459
22053	1	Black	25mm		11mm	45mm	431
22054	6	Black	20mm		7mm	16mm	445
22056	8	White	18mm	13mm	8.5mm x 8.5mm	13mm	452
22057	8	Black	18mm	13mm	9mm	12mm	450
22060	3	Black	6.5mm x 16mm		3.5mm x 5.5mm	8mm	439
22063	Misc.	White	12mm	13mm		14mm	452
22071	Misc.	Black	20mm			15mm	448
22073	Misc.	Black	32mm			12mm	448
22075	1	Black	20mm		8.7mm	16mm	422
22082	6	Black	26mm			14mm	445
22086	Misc.	Black	22mm	30mm		14mm	474
22090	10	Brown	20mm	11.6mm x 15mm		16mm	469
22091	1	Black	20mm		7mm	24mm	473
22092	8	Black	18.5mm	30mm		14mm	474
22093	7	Black	12.3mm	12.3mm	5.5mm	17mm	454
22103	4	Black	20mm		9mm	9mm	435
22107	Misc.	Black	6mm x 15mm		5.6mm x 7mm	12mm	436
22132	Misc.	Gray	22mm	20mm		11mm	454
22133	Misc.	Red	16mm	10mm		7.8mm	451
22149	10	Blue	18mm	14mm	10mm	16mm	468
22152	10	White	18mm	12.5mm	11.5mm	10mm	459
22153	8	White	15mm	8mm x 10mm	12mm	8mm	449
22156	10	White	17mm	13mm		13mm	462
22157	10	Yellow	18mm	13mm	12mm	11mm	464
22162	3	Orange	5mm x 15mm		8mm	8mm	438
22168	Misc.	Black	18mm x 21.5mm			9mm	435
22179	Misc.	Black	18mm	13mm	10.8mm	14.5mm	451
22180	1	Black	23mm		7.6mm	30mm	424
22206	9	White	15mm	13mm	9.6mm x 9.6mm	14mm	467

**Sec. 19**

**RETAINER SPECIFICATION CHART**

Recommended Hole Size: .030" - .060" smaller than stem diameter

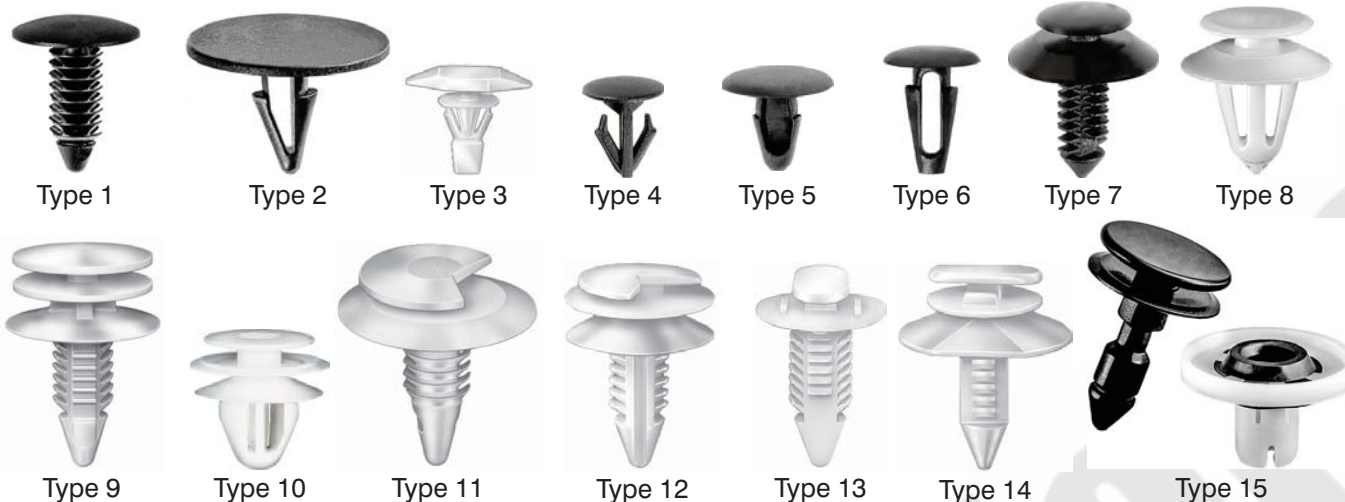

Auveco Part No.	Type	Color	Bottom Head Diameter	Top Head Diameter	Stem Diameter	Stem Length	Page No.
22207	8	Black	17mm	11mm x 14mm	9.7mm	12mm	451
22209	4	Black	20mm			19mm	448
22211	1	Black	23mm		8mm	15mm	432
22212	6	Black	4.3mm x 11mm		6.2mm	10mm	444
22214	6	Black	7.5mm		5.5mm	10mm	443
22220	10	White	19mm	14mm		14mm	467
22221	Misc.	Black	71mm			15mm	445
22229	10	Gray	18mm	14.5mm	9.5mm	14mm	466
22231	10	Black	12mm	10mm	8mm	9mm	458
22233	1	Black		32mm	8.5mm	16mm	433
22236	8	White	18mm	13mm	9.3mm	13mm	451
22237	10	White	18mm	13mm	9mm	13mm	463
22240	8	Yellow	17mm	15mm	9mm	14mm	450
22243	8	White	16mm	13mm	9.5mm	12mm	450
22244	8	White	17mm	14mm	10.8mm	11mm	454
22245	Misc.	Black	19mm			23mm	474
22250	7	Black	18mm	15mm	7.2mm	20mm	470
22251	Misc.	White	15mm	14.5mm	11mm	15mm	453
22252	10	Yellow	18mm	13mm	10.5mm	12mm	451
22254	Misc.	Black	31mm		7mm	12mm	448
22259	7	Black	21mm	13mm	7.4mm	14mm	455
22263	6	Black	16mm		8mm	11mm	445
22267	10	White	18mm	13mm	11mm	14mm	465
22269	Misc.	White	14.5mm	14.5mm	10mm	12mm	460
22278	8	Gray	17mm	13mm	9mm	14mm	453
22279	8	Yellow	17mm	15mm	9mm	15mm	454
22285	10	Red	18mm	14.3mm	9.5mm	13mm	462
22286	Misc.	White	14mm			10mm	445
22288	9	Green	18mm	13mm	9.5mm	15mm	467
22302	3	Yellow	6.5mm	5mm x 15mm	8mm	8mm	439
22305	10	Yellow	17mm	13.3mm	9.3mm	13mm	460
22309	10	White	17mm	13.3mm	9.3mm	13mm	461
22310	3	White	9.5mm x 16.5mm			13.5mm	437
22312	10	Gray	15mm	13mm	9.5mm	12mm	460
22313	10	Green	18mm	13mm	10mm	10mm	459
22315	Misc.	Gray	18mm	13mm	9mm	15mm	466
22320	3	Black	5mm x 13mm		8mm	10mm	436
22321	3	Black	4.5mm x 13mm		7.6mm	7.5mm	436
22325	3	Red	5mm x 15mm		7mm	8mm	439
22336	10	White	12mm	10mm	7.2mm	10mm	458
22337	3	White	9.3mm	5mm x 15mm	7mm	11mm	446
22338	1	Black	26mm		7.6mm	28mm	431
22343	10	Green	15mm	13mm	9.8mm	10mm	459
22355	3	Green	11mm	5mm x 15mm	8mm	9.5mm	438
22356	3	Pink	11mm	5mm x 5mm	8mm	9.5mm	438



# PUSH-TYPE RETAINERS

Refer to Retainer Specification Chart on pages 534-545  
Listed smallest to largest by Head Diameter, Stem Length and then by Hole Diameter.



**17227**  
(21077405)  
Black Nylon

Door Handle to Door Hardware Attachment Push-Type Retainer  
Head Diameter: 7mm  
Stem Length: 10mm  
Fits into 5mm Hole  
2 Door & 4 Door Models  
GM Saturn 1991 - On

UNIT PACKAGE: 25



**21780**  
(BMW: 51-47-8-166-992)  
Black Nylon

Trunk Lid Compartment Trim & Wheel Well Push-Type Retainer  
Head Diameter: 9mm  
Stem Length: 7mm  
Fits into 5mm Hole  
3, 5, & M Series 1993 - On

UNIT PACKAGE: 25



**19854**  
(21097229)

Door Handle Push-Type Retainer  
Head Diameter: 7mm  
Stem Length: 10mm  
Fits into 5mm Hole  
Saturn 2 Door & 4 Door 1999 - On

UNIT PACKAGE: 25



**14016**  
(GM: 16500308; Chry: 6500787)  
Black Nylon

Tail Light Retainer  
Large Head Diameter: 3/8" (9.5mm)  
Stem Length: 7/16" (11mm)  
Fits into 3/16" (4.8mm) Hole  
GM & Chrysler

UNIT PACKAGE: 25



**21967**  
(Peugeot & Citroen: 6902.07)  
Black Nylon

Push-Type Retainer  
Head Diameter: 8mm  
Stem Length: 7mm  
Fits into 3.5mm Hole  
Peugeot & Citroen

UNIT PACKAGE: 100



**13999**  
(20363491)  
Black Nylon

Body Side Moulding Push-Type Retainer  
Large Head Diameter: 3/8" (9.5mm)  
Stem Length: 1/2" (12.7mm)  
Fits into 7/32" (5.6mm) Hole  
GM 1979 - On

UNIT PACKAGE: 25



**21968**  
(Peugeot & Citroen: 6972.24;  
Renault & Dacia: 77-03-072-224)  
Black Nylon

Push-Type Retainer  
Head Diameter: 8mm  
Stem Length: 8mm  
Fits into 4mm Hole  
Peugeot, Citroen, Renault & Dacia

UNIT PACKAGE: 25



**13230**  
(Mercedes: 000-990-03-92;  
Volvo: 947-098)  
Black Nylon

Push-Type Retainer  
Head Diameter: 10mm  
Stem Diameter: 7mm  
Fit into 5mm Hole

UNIT PACKAGE: 50



**21585**  
(909130003)  
Black Nylon

Upper Grille Push-Type Retainer  
Head Diameter: 9mm  
Stem Diameter: 7mm  
Fits into 4mm Hole  
Subaru Baja, Legacy, & Outback  
2006 - 2000

UNIT PACKAGE: 25



**22230**  
(Subaru: 909140059)  
Black Nylon

Front & Rear Bumper Push-Type Retainer  
Head Diameter: 10mm  
Stem Length: 8.5mm  
Fits into 5mm Hole  
Subaru Forester, Impreza, Legacy,  
Outback, WRX, XV Crosstrek 2008 - On

UNIT PACKAGE: 15

**Sec. 19**

**PUSH-TYPE RETAINERS**

Refer to Retainer Specification Chart on pages 534-545

Listed smallest to largest by Head Diameter, Stem Length and then by Hole Diameter.



**21663**  
(EA01-50-037)  
Black Nylon

Push-Type Retainer  
Head Diameter: 10mm  
Stem Length: 9mm  
Fits into 5mm Hole  
Mazda 2, 3, CX7, CX9, MX3,  
MX5 Miata & RX8 1992 - On

UNIT PACKAGE: 15



**21779**  
(BMW: 51-46-7-002-606)  
Black Nylon

Front Bumper, Grille, Trunk Panel  
& Rear Window Push-Type Retainer  
Head Diameter: 10mm  
Stem Length: 11mm  
Fits into 6.3mm Hole  
3, 5, 7 & Z Series 1997 - On

UNIT PACKAGE: 25



**22125**  
(Toyota: 90467-05170)  
Black Nylon

Front Bumper Push-Type Retainer  
Head Diameter: 10mm  
Stem Length: 10mm  
Fits into 5mm Hole  
Lexus IS 250, IS 350 & NX 300h and  
Toyota Corolla, Highlander, Matrix & RAV4  
2012 - On

UNIT PACKAGE: 25



**21103**  
(90467-05090-B1)  
Black Nylon

Front Bumper Fascia Push-Type Retainer  
Head Diameter: 10mm  
Stem Length: 12mm  
Fits into 5mm Hole  
Toyota Corolla, Matrix & Scion 2008 - On

UNIT PACKAGE: 10



**21037**  
(000-990-84-92)  
Black Nylon

Push-Type Retainer  
Head Diameter: 10mm  
Stem Length: 10mm  
Fits into 6mm Hole  
Mercedes-Benz 2005-On

UNIT PACKAGE: 25



**21881**  
(Peugeot & Citroen: 6972.11)  
Black Nylon

Mud Flap Push-Type Retainer  
Head Diameter: 10mm  
Stem Length: 12mm  
Fits into 6.3mm Hole  
Peugeot & Citroen

UNIT PACKAGE: 25



**20187**  
(BMW: 51-16-1-881-149;  
Mercedes: 000-990-34-92;  
VW: N-102-593-01)  
Black Nylon

Radiator Housing Push-Type Retainer  
Head Diameter: 10mm  
Stem Length: 10mm  
Fits into 6mm Hole  
Body Styles 116, 123, 124, 136, 129, 140,  
170, 201, 208, & 210 1974 - On  
BMW & VW

UNIT PACKAGE: 15



**21233**  
(86157-3700)  
Black Nylon

Hood Mounting Push-Type Retainer  
Head Diameter: 10mm  
Stem Length: 13mm  
Fits into 5mm Hole  
Hyundai Azera 2009 - On

UNIT PACKAGE: 25



**22238**  
(VW: N-905-369-01)  
Black Nylon

Bumper, Hood, Interior Trim &  
Quarter Panel Push-Type Retainer  
Head Diameter: 10mm  
Stem Length: 11mm  
Fits into 5mm Hole  
Audi 90, A4 & S4 and VW Beetle,  
Golf & Jetta 1993 - On

UNIT PACKAGE: 25



**11702**  
(D6EA-1A100-AA)  
Natural Nylon

Wheel Ornament Push-Type Retainer  
Head Diameter: 25/64" (10mm)  
Stem Length: 19/32" (15mm)  
Fits into 9/32" (7.1mm) Hole  
Ford 1976 - On

UNIT PACKAGE: 50

# PUSH-TYPE RETAINERS

## Sec. 19

Refer to Retainer Specification Chart on pages 534-545  
Listed smallest to largest by Head Diameter, Stem Length and then by Hole Diameter.



### 19242

(15672149)  
Black Nylon

Air Inlet Grille Panel Push-Type Retainer  
Head Diameter: 13/32" (10.3mm)  
Stem Length: 11/16" (17.5mm)  
Fits into 7/32" (5/6mm) Hole  
GM Jimmy, Blazer, S-10, & Bravada  
1994 - On

UNIT PACKAGE: 25



### 19186

(90657-SB0-003)  
Black Nylon

Front Bumper Cover Push-Type Retainer  
Head Diameter: 11mm  
Stem Length: 10mm  
Fits into 8mm Hole  
Acura Legend, Honda  
Accord & Odyssey 1991 - On

UNIT PACKAGE: 10



### 21972

(Peugeot & Citroen: 6992.18)  
Black Nylon

Push-Type Retainer  
Top Head Diameter: 10.5mm  
Bottom Head Diameter: 11mm  
Stem Length: 6mm  
Fits into 6mm Hole  
Overall Length: 24.5mm  
Peugeot & Citroen

UNIT PACKAGE: 15



### 21662

(S51S-51-833)  
Black Nylon

Push-Type Retainer  
Head Diameter: 11mm  
Stem Length: 11mm  
Fits into 7mm Hole  
Mazda 3, MX5 Miata & RX8 2004 - On

UNIT PACKAGE: 15



### 21989

(VW: 191-867-775A)  
Black Nylon

Tailgate Push-Type Retainer  
Top Head Diameter: 11mm  
Bottom Head Diameter: 12mm  
Stem Length: 7mm  
Fits into 7mm Hole  
Overall Length: 27mm  
VW, Audi, SEAT & Skoda

UNIT PACKAGE: 10



### 14990

(22538102)  
Black Nylon

Push-Type Retainer  
Head Diameter: 7/16" (11mm)  
Stem Length: 15/32" (11.9mm)  
Fits into 15/64" (6mm) Hole  
GM 1987 - On

UNIT PACKAGE: 50



### 11854

(14005089)  
Natural Nylon

Air Conditioning Vent &  
General Purpose Push-Type Retainer  
Head Diameter: 7/16" (11mm)  
Stem Length: 9/32" (7.1mm)  
Fits into 3/16" (4.8mm) Hole  
GM 1979 - On

UNIT PACKAGE: 25



### 17383

(96057847)  
Black Nylon

Radiator Grille & Trim Panel  
Push-Type Retainer  
Head Diameter: 11mm  
Stem Length: 14mm  
Fits into 7mm Hole  
Geo Tracker & Prizm 1992-89

UNIT PACKAGE: 10



### 21218

(90467-05063-C0)  
Black Nylon

Front Bumper Push-Type Retainer  
Head Diameter: 11mm  
Stem Length: 8mm  
Fits into 5mm Hole  
Toyota Corolla 2009 - On

UNIT PACKAGE: 15



### 21249

(90467-07071-22)  
Black Nylon

Bumper Cover Push-Type Retainer  
Head Diameter: 11mm  
Stem Length: 14mm  
Fits into 7mm Hole  
Toyota Yaris 2009 - On

UNIT PACKAGE: 25

**Sec. 19**

**PUSH-TYPE RETAINERS**

Refer to Retainer Specification Chart on pages 534-545

Listed smallest to largest by Head Diameter, Stem Length and then by Hole Diameter.



**21711**  
(Mercedes-Benz: 000-991-59-40)  
Black Nylon & Santoprene Rubber

Push-Type Retainer  
Head Diameter: 11mm  
Stem Length: 16mm  
Fits into 6mm Hole  
CLS55, CLS500, C Class,  
E Class & Slk Class 2006 - On

UNIT PACKAGE: 15



**18032**  
(6502573)  
Black Nylon

Cowl Screen Attachment  
Push-Type Retainer  
Head Size: 15/32" (11.9mm)  
Stem Length: 9/16" (14.3mm)  
Fits into 1/4" (6.4mm) Square Hole  
Chrysler Concorde & LHS, Dodge Intrepid  
& Eagle Vision 1993 - On

UNIT PACKAGE: 15



**14988**  
(Ford: N805229S;  
GM: 15648833, 22595587)  
Black Nylon

Push-Type Retainer  
Head Diameter: 7/16" (11mm)  
Stem Length: 11/16" (17.5mm)  
Fits into 15/64" (6mm) Hole  
Ford & GM 1987 - On

UNIT PACKAGE: 25



**16783**  
(66824-01G00)  
Black Nylon

Push-Type Retainer  
Head Diameter: 12mm  
Stem Length: 8mm (Excluding the Pin)  
Fits into 6mm Hole  
Nissan

UNIT PACKAGE: 25



**17214**  
(GM: 10089262, 21042098;  
Chrysler: 55075139)  
Black Nylon

Push-Type Retainer  
Head Diameter: 11mm (7/16")  
Stem Length: 18mm (11/16")  
Fits into 6mm (15/64") Hole  
GM & Saturn 4 Door & Station Wagon 1987 - On

UNIT PACKAGE: 25

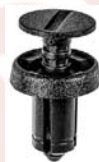

**21935**  
(Renault & Dacia: 77-03-072-361)  
Black Nylon

Push-Type Retainer  
Head Diameter: 12mm  
Stem Length: 10mm  
Fits into 6mm Hole  
Renault & Dacia

UNIT PACKAGE: 15



**20636**  
(123-990-00-92)  
Dark Gray Nylon

Push-Type Retainer  
Head Diameter: 12mm  
Stem Length: 10mm  
Fits into 8.5mm Hole  
Mercedes-Benz

UNIT PACKAGE: 15



**14987**  
Same as 17214 except unit package quantity

UNIT PACKAGE: 50



**21391**  
(N038-550-1)  
Dark Gray Nylon

Bumper, Exterior Trim, Fender,  
Quarter Panel & Wheel Opening  
Push-Type Retainer  
Head Diameter: 12mm  
Stem Length: 11mm  
Fits into 8mm Hole  
Audi and Volkswagen EuroVan,  
Golf, Jetta & Passat 2003 - 1985

UNIT PACKAGE: 25

# PUSH-TYPE RETAINERS

## Sec. 19

Refer to Retainer Specification Chart on pages 534-545  
Listed smallest to largest by Head Diameter, Stem Length and then by Hole Diameter.



**20639**  
(000-990-44-92)  
Black Nylon

Push-Type Retainer  
Head Diameter: 12mm  
Stem Length: 11mm  
Fits into 5mm x 5mm Hole  
Mercedes-Benz

UNIT PACKAGE: 25



**21246**  
(22690838)  
Black Nylon

Door Trim Push-Type Retainer  
Head Diameter: 12mm  
Stem Length: 14mm (Excluding the Pin)  
Fits into 6mm Hole  
Chevrolet Malibu & Pontiac G6 2004 - On

UNIT PACKAGE: 25



**20640**  
(000-990-40-92, 124-990-05-92-9051)  
Black Nylon

Push-Type Retainer  
Head Diameter: 12mm  
Stem Length: 11mm  
Fits into 5mm Hole  
Mercedes-Benz

UNIT PACKAGE: 25



**19787**  
(22657634)  
Black Nylon

Fender & Rocker Panel  
Push-Type Retainer  
Head Diameter: 12mm  
Stem Length: 17mm  
Fits into 6mm Hole  
Chevrolet Malibu, Oldsmobile Achieva &  
Cutlass and Pontiac Grand Am 1999 - On

UNIT PACKAGE: 25



**21882**  
(Peugeot & Citroen: 6991.F0;  
Renault & Dacia: 77-03-072-261)  
Black Nylon

Push-Type Retainer  
Torx® Drive (T27)  
Head Diameter: 12mm  
Stem Length: 14mm  
Fits into 6mm Hole  
Peugeot, Citroen, Renault & Dacia

UNIT PACKAGE: 25



**19522**  
(22644361)  
Black Nylon

Door Sill Trim Plate Push-Type Retainer  
Head Diameter: 12mm  
Stem Length: 18mm  
Fits into 6mm Square Hole  
Chevrolet Malibu, Olds Achieva  
& Cutlass 1997 - On

UNIT PACKAGE: 15



**22303**  
(BMW: 51-16-8-197-908)  
Black Nylon

Upper Cover & Spoiler  
Push-Type Retainer  
Head Diameter: 12mm  
Stem Length: 13mm  
Fits into 7mm Hole  
BMW 1, 3, M3 & Z4 and  
Mini-Cooper Base, John Cooper Works,  
Countryman & Paceman 2013 - On

UNIT PACKAGE: 15



**21875**  
(Peugeot & Citroen: 6555.LE;  
Renault & Dacia: 77-03-072-236)  
Black Nylon

Push-Type Retainer  
Torx® Drive (T27)  
Head Diameter: 12.5mm  
Stem Length: 9mm  
Fits into 6mm Hole  
Peugeot, Citroen, Renault & Dacia

UNIT PACKAGE: 25



**20666**  
(22677979, 22677980)  
Gray Nylon

Door Trim  
Push-Type Retainer  
Head Diameter: 12mm  
Stem Length: 14mm (Excluding the Pin)  
Fits into 6mm Hole  
Chevrolet Malibu 2004 - On

UNIT PACKAGE: 25



**22201**  
(BMW: 51498166702)

Trim Panel Push-Type Retainer  
Head Diameter: 12.5mm  
Stem Length: 12mm  
Fits into 8.5mm Hole  
BMW 1, 2, 3, 5, 6, 7, X & Z Series  
1995 - On

UNIT PACKAGE: 15

**Sec. 19**

**PUSH-TYPE RETAINERS**

Refer to Retainer Specification Chart on pages 534-545

Listed smallest to largest by Head Diameter, Stem Length and then by Hole Diameter.



**20163**  
(25099299)  
Black Nylon

Radiator Sight Shield &  
Air Filter Housing Push-Type Retainer  
Head Diameter: 12.5mm  
Stem Length: 17mm  
Fits into 6mm Hole  
GM 1994 - On

UNIT PACKAGE: 15



**21970**  
(Peugeot & Citroen: 6990.C4)  
Black Nylon

Push-Type Retainer  
Head Diameter: 13mm  
Stem Length: 10mm  
Fits into 6mm Hole  
Peugeot & Citroen

UNIT PACKAGE: 25



**17106**  
(GM: 22566221;  
Chrysler: 6501577)  
Black Nylon

Headlight Door Push-Type Retainer  
Top Head Diameter: 1/2" (12.7mm)  
Stem Length: 7/16" (11mm)  
Fits into 3/16" (4.8mm) Hole  
GM Blazer & Suburban 1991 - On  
Chrysler New Yorker, Landau &  
5th Avenue 1988 - On

UNIT PACKAGE: 50



**22178**  
(Ford: W707365-S300)  
Black Nylon

Front Fender Push-Type Retainer  
Head Diameter: 13mm  
Stem Length: 10mm  
Fits into 7mm Hole  
Ford Edge 2015 - On

UNIT PACKAGE: 10



**14995**  
(GM: 10195515;  
Ford: N805026S;  
Chrysler: 4696488, 6503163)  
Black Nylon

Push-Type Retainer  
Head Diameter: 1/2" (12.7mm)  
Stem Length: 1-13/64" (30.5mm)  
Fits into 9/32" (7mm) Hole  
GM, Ford & Chrysler 1987 - On

UNIT PACKAGE: 25



**17287**  
(90687-SB0-003, 90687-SB0-013)  
Black Nylon

Cowl Vent Panel Retainer  
Head Diameter: 13mm  
Stem Length: 11mm  
Fits into 6mm Hole  
Honda Prelude 1983 - On

UNIT PACKAGE: 25



**21769**  
(Mazda: G14S-50-EA1)  
Black Nylon

Push-Type Retainer  
Head Diameter: 13mm  
Stem Length: 13mm  
Fits into 8mm Hole  
CX7 & Miata 2004 - On

UNIT PACKAGE: 25



**22155**  
(Land Rover: LR033144)  
Black Nylon

Pillar, Rocker & Floor Moulding  
Push-Type Retainer  
Head Diameter: 13mm  
Stem Length: 13mm  
Fits into 8mm Hole  
Land Rover HSE & Range Rover  
2012 - On

UNIT PACKAGE: 15

**GET THE KIT THAT FITS**

**We have several assortments  
in the green section. Find the kit  
that holds the push-type retainers  
you use the most.**

# PUSH-TYPE RETAINERS

Refer to Retainer Specification Chart on pages 534-545  
Listed smallest to largest by Head Diameter, Stem Length and then by Hole Diameter.



**20314**  
(000-990-37-92)  
Black Nylon

Trunk Trim & General Purpose  
Push-Type Retainer  
Head Diameter: 13mm  
Stem Length: 14mm  
Fits into 8mm Hole  
Mercedes-Benz SL500 &  
SL600 Convertible 1999 - On

UNIT PACKAGE: 15



**19726**  
(94858343)  
Black Nylon

Door Trim Panel  
Push-Type Retainer  
Head Diameter: 14mm  
Stem Length: 8mm  
Fits into 6mm Hole  
Geo Prizm 1998 - On

UNIT PACKAGE: 15



**21849**  
(Toyota: 90467-05136)  
Black Nylon

Inner Door Lock Plate, Engine Cover &  
Outside Air Duct Push-Type Retainer  
Head Diameter: 13mm  
Stem Length: 15mm  
Fits into 5.5mm Hole  
Lexus & Toyota 2012 - On

UNIT PACKAGE: 25



**19645**  
(94858864)  
Gray Nylon

Door Trim Panel  
Push-Type Retainer  
Head Diameter: 14mm  
Stem Length: 8mm  
Fits into 6mm Hole  
Geo Prizm 1998 - On

UNIT PACKAGE: 15



**21172**  
(W713202-S300,  
W713445-S300)  
Black Nylon

Bumper Push-Type Retainer  
Head Diameter: 13mm  
Stem Length: 18mm  
Fits into 8mm Hole  
Ford Fusion 2006 - On

UNIT PACKAGE: 15



**22058**  
(Ford: N807673-S)  
Black Nylon

Tailgate Push-Type Retainer  
Head Diameter: 14mm  
Stem Length: 9mm  
Fits into 7mm Hole  
Ford Explorer Sport Trac 2010 - 2007

UNIT PACKAGE: 10



**19355**  
(15960621)  
Black Nylon

Rear Door Radio Speaker  
Push-Type Retainer  
Head Diameter: 17/32" (13.5mm)  
Stem Length: 1-5/64" (27.5mm)  
Fits into 1/4" (6.4mm) Hole  
GM Trucks C & K 1, 2 1995 - On

UNIT PACKAGE: 25



**21451**  
(333-867-633-4FB)  
Black Nylon

Front Lights & Windshield Washer  
Push-Type Retainer  
Head Diameter: 14mm  
Stem Length: 10mm  
Fits into 8.5mm Hole  
VW 1998 - 95

UNIT PACKAGE: 25



**20196**  
(90467-06133-CO)  
Black Nylon

Rocker Panel Push-Type Retainer  
Head Diameter: 14mm  
Stem Length: 8mm  
Fits into 6mm Hole  
Toyota 4-Runner 1998 - On

UNIT PACKAGE: 15



**14697**  
(GM: 94198687;  
Honda: 90657-SA6-0030;  
Mazda: N304-13-356-A)  
Black Nylon

Push-Type Retainer  
Head Diameter: 14mm  
Stem Length: 11mm  
Fits into 7mm Hole

UNIT PACKAGE: 25

**Sec. 19**

**PUSH-TYPE RETAINERS**

Refer to Retainer Specification Chart on pages 534-545

Listed smallest to largest by Head Diameter, Stem Length and then by Hole Diameter.



**16816**  
(21047094)  
Black Nylon

Push-Type Retainer  
Top Head Diameter: 14mm  
Stem Length: 14mm  
Fits into 6mm Hole  
GM Saturn 1991 - On

UNIT PACKAGE: 25



**19337**  
(N808908-S)  
Black Nylon

Headlight Accessory Push-Type Retainer  
Head Diameter: 14mm  
Stem Length: 23mm  
Fits into 6.3mm (1/4") Hole  
Ford Mustang 1996 - On

UNIT PACKAGE: 10



**21104**  
(90467-07190-B2)  
Black Nylon

Interior Trim Push-Type Retainer  
Head Diameter: 14mm  
Stem Length: 14mm  
Fits into 7mm Hole  
Toyota Echo & Scion 2004 - On

UNIT PACKAGE: 10



**20943**  
(15014352)  
Black Nylon

Cowl Vent Push-Type Retainer  
Head Diameter: 14mm  
Stem Length: 23mm  
Fits into 7mm Hole  
Buick Lucerne 2006 - On

UNIT PACKAGE: 15



**17478**  
(B101-68-252-00)  
Black Nylon

Interior Trim Push-Type Retainer  
Head Diameter: 14mm  
Stem Length: 16mm  
Fits into 6mm Hole  
Ford Probe & Mazda MX6 1988 - On

UNIT PACKAGE: 25



**18353**  
(15960325)  
White Nylon

Door Trim Panel Push-Type Retainer  
Head Diameter: 9/16" (14.3mm)  
Stem Length: 41/64" (16.3mm)  
Fits into 1/4" (6.4mm) Hole  
GM Trucks C, K, 1, 2, 3 1995 - On

UNIT PACKAGE: 50



**16859**  
(Nissan: 66860-01W01;  
GM: 94051993)  
Black Nylon

Cowl Panel to Reinforcement Plate &  
Engine Splash Shield Push-Type Retainer  
Head Diameter: 14mm (9/16")  
Stem Length: 16mm (5/8")  
Fits into 6mm (1/4") Hole  
Nissan 1980 - On  
Geo Storm 1990 - On

UNIT PACKAGE: 25



**21593**  
(46064AE000)  
Black Nylon

Front Fender, Bumper &  
Quarter Panel Push-Type Retainer  
Head Diameter: 15mm  
Stem Length: 8mm  
Fits into 7mm Hole  
Subaru Baja, Forester, Impreza,  
Legacy & Outback 2003 - On

UNIT PACKAGE: 10



**22349**  
(Ford: W719367-S300)  
Black Nylon

Push-Type Retainer  
Head Diameter: 14mm  
Stem Length: 18mm  
Fits into 8mm x 11mm Hole  
Ford

UNIT PACKAGE: 15



**21990**  
(VW: 6L0-121-136A)  
Black Nylon

Push-Type Retainer  
Head Diameter: 15mm  
Stem Length: 8mm  
Fits into 7mm Hole  
VW, Audi, SEAT & Skoda

UNIT PACKAGE: 15



# PUSH-TYPE RETAINERS

Refer to Retainer Specification Chart on pages 534-545  
Listed smallest to largest by Head Diameter, Stem Length and then by Hole Diameter.



## 21328

(86155-2H100)  
Black Nylon

Cowl & Bumper Push-Type Retainer  
Head Diameter: 15mm  
Stem Length: 10mm  
Fits into 7mm Hole  
Hyundai Genesis & Veracruz  
and Kia Rio 2009 - On

UNIT PACKAGE: 15



## 22160

(Subaru: 909140062)  
Black Nylon

Front & Rear Bumper  
Push-Type Retainer  
Head Diameter: 15mm  
Stem Length: 10mm  
Fits into 7mm Hole  
Subaru BRZ, Forester, Impreza &  
XV Crosstrek 2008 - On

UNIT PACKAGE: 15



## 19013

(90467-07059-22)  
Black Nylon

Rear Door Trim &  
Luggage Compartment Door  
Push-Type Retainer  
Head Diameter: 15mm  
Stem Length: 10mm  
Fits into 7mm Hole  
Toyota Camry & Celica 1990 - On

UNIT PACKAGE: 15



## 22280

(VW: 3C0-853-934)  
Black Nylon

Splash Shield & Rocker  
Moulding Push-Type Retainer  
Head Diameter: 15mm  
Hex: 8mm (with 4mm Allen Drive)  
Stem Length: 10mm  
Fits into 8mm Hole  
Volkswagen CC 2009 - On  
Passat 2010 - 2006

UNIT PACKAGE: 25



## 14696

(Honda: 90684-SA5-0030;  
Isuzu: 8942981190;  
Nissan 10998-30880)  
Black Nylon

Push-Type Retainer  
Head Diameter: 15mm  
Stem Length: 11mm  
Fits into 6mm Hole

UNIT PACKAGE: 25



## 21658

(Mitsubishi: MR288150;  
Subaru: 909130013)  
Black Nylon

Push-Type Retainer  
Head Diameter: 15mm  
Stem Length: 11mm  
Fits into 6mm Hole  
Mitsubishi Endeavor, Galant, Lancer,  
Mirage, Montero & Outlander 1997 - On  
Subaru BRZ, Forester, Impreza, Legacy,  
Outback, & XV Crosstrek 2004 - On

UNIT PACKAGE: 10



## 21140

(MB619582)  
Black Nylon

Interior Trim, Bumper & Grille  
Push-Type Retainer  
Head Diameter: 15mm  
Stem Length: 12mm  
Fits into 6.3mm Hole  
Mitsubishi Eclipse, Endeavor,  
Lancer & Outlander 2002 - On

UNIT PACKAGE: 25



## 22199

(Honda: 90657-SA5-003)  
Black Nylon

Bumper & Splash Shield  
Push-Type Retainer  
Head Diameter: 15mm  
Stem Length: 12mm  
Fits into 6.3mm Hole  
Acura TL 2008 - 04  
Honda Accord, CR-V, Insight  
& Pilot 2007 - 1997

UNIT PACKAGE: 15



## 14260

(Toyota: 90467-06017;  
Mazda: 9926-50-625;  
GM: 20426301)  
Black Nylon

Push-Type Retainer  
Head Diameter: 15mm  
Stem Length: 12mm  
Fits into 7mm Hole

UNIT PACKAGE: 15

**Sec. 19**

**PUSH-TYPE RETAINERS**

Refer to Retainer Specification Chart on pages 534-545

Listed smallest to largest by Head Diameter, Stem Length and then by Hole Diameter.



**20580**  
(MR478262)  
Black Nylon

Bumper Cover & Garnish Moulding  
Push-Type Retainer  
Top Head Diameter: 15mm  
Bottom Head Diameter: 14mm  
Stem Length: 12mm  
Fits into 7mm Hole  
**Use with Auveco 20581**  
Chrysler Sebring & Stratus  
and Mitsubishi Eclipse 2000 - On

UNIT PACKAGE: 15



**19142**  
(91550-SH3-003)  
Black Nylon

Pillar Garnish, Side and  
Trunk Lining Push-Type Retainer  
Head Diameter: 15mm  
Stem Length: 13mm  
Fits into 7mm Square Hole  
Honda Civic, Accord Wagon  
& Del Sol 1993 - On

UNIT PACKAGE: 5



**17206**  
(90467-09145)  
Black Nylon

Bumper Cover Push-Type Retainer  
Head Diameter: 15mm  
Stem Length: 12mm (Excluding the Pin)  
Fits into 9mm Hole  
Toyota Camry 1992 - On

UNIT PACKAGE: 15



**20169**  
(W701971-S)  
White Nylon

Door Trim Panel Push-Type Retainer  
Head Diameter: 15mm  
Stem Length: 13mm  
Fits into 7mm Hole  
Lincoln LS 2000 - On

UNIT PACKAGE: 25



**20363**  
(Not Available from O.E.M.)  
White Nylon

Door Trim Panel  
Push-Type Retainer  
Top Head Diameter: 15mm  
Bottom Head Diameter: 20mm  
Stem Length: 12mm (Excluding the Pin)  
Fits into 9mm Hole  
Ford 2001 - On

UNIT PACKAGE: 25



**21620**  
(01553-06071)  
Black Nylon

Rear Duct Finishing Panel  
Push-Type Retainer  
Head Diameter: 15mm  
Stem Length: 14mm  
Fits into 5mm Hole  
Nissan Cube S, SL,  
Krom & Leaf 2012 - On

UNIT PACKAGE: 15



**17162**  
(GM: 96057846;  
Hyundai: 86155-22000  
Toyota: 90467-07041)  
Black Nylon

Push-Type Retainer  
Head Diameter: 15mm  
Stem Length: 13mm  
Fits into 6.3mm Hole  
Geo Metro & Tracker, Hyundai and Toyota 1989 - On

UNIT PACKAGE: 10



**21112**  
(94530438)  
Black Nylon

Fender Liner Push-Type Retainer  
Head Diameter: 15mm  
Stem Length: 14mm  
Fits into 6mm Hole  
Chevrolet Aveo 2004 - On

UNIT PACKAGE: 25



**19311**  
(90683-SA5-003)  
Black Nylon

Front Fender Skirt Push-Type Retainer  
Head Diameter: 15mm  
Stem Length: 13mm  
Fits into 6mm Hole  
Honda Prelude 1996 - 92

UNIT PACKAGE: 15



**21120**  
(90467-07192)  
Black Nylon

Cowl Vent Push-Type Retainer  
Head Diameter: 15mm  
Stem Length: 14mm  
Fits into 7mm Hole  
Toyota RAV 4 2002 - On

UNIT PACKAGE: 15

# PUSH-TYPE RETAINERS

Refer to Retainer Specification Chart on pages 534-545  
Listed smallest to largest by Head Diameter, Stem Length and then by Hole Diameter.



**20234**  
(BMW: 51-11-1-908-077;  
Mercedes: 00-990-54-92)  
Black Nylon  
Scuff Plate Push-Type Retainer  
Head Diameter: 15mm  
Stem Length: 15mm  
Fits into 6.3mm Hole  
BMW Series 3, 5 & 7 1984 - On  
Mercedes 2014 - 1994

UNIT PACKAGE: 50



**21645**  
(Not Available from O.E.M.)  
Black Nylon  
Bumper & Wheel Opening  
Push-Type Retainer  
Head Diameter: 15mm  
Stem Length: 15mm  
Fits into 6.3mm Hole  
BMW 2004 - On

UNIT PACKAGE: 15



**11705**  
(387843-S)  
Black Nylon  
Fender Shield Retainer  
Head Diameter: 19/32" (15mm)  
Stem Length: 5/8" (16mm)  
Fits into 1/4" (6.4mm) Hole  
Ford 1978 - On

UNIT PACKAGE: 50



**21011**  
(90467-07188)  
Black Nylon  
Push-Type Retainer  
Head Diameter: 15mm  
Stem Length: 17mm  
Fits into 7mm Hole  
Toyota Camry, Tundra & 4-Runner  
2002 - On

UNIT PACKAGE: 15



**19801**  
(21077123)  
Black Nylon  
Wheel Opening Moulding  
Push-Type Retainer  
Head Diameter: 19/32" (15mm)  
Stem Length: 3/4" (19mm)  
Fits into 1/4" (6.4mm) Hole  
Saturn 1991 - On

UNIT PACKAGE: 25



**17222**  
(GM: 21075686;  
Ford: F3LY-14570-B)  
Black Nylon  
Rocker Panel, Wheel Liner &  
Air Inlet Duct Push-Type Retainer  
Head Diameter: 15mm  
Stem Length: 20mm  
Fits into 8mm Hole  
GM Saturn 2 Door & 4 Door Models 1991 - On  
Ford

UNIT PACKAGE: 25



**22347**  
(GM: 11561878)  
Black Nylon  
Bumper, Fender Liner, Cowl, Grille,  
Air Inlet Duct, Rocker Panel, Wheel Liner,  
Quarter Panel & Upper Deflector  
Push-Type Retainer with Sealer  
Head Diameter: 15mm  
Stem Length: 21mm  
Fits into 8mm Hole  
Various Buick, Cadillac Chevrolet,  
GMC, Hummer, Saab &  
Saturn Models 1991 - On

UNIT PACKAGE: 25

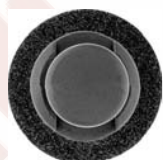

**14997**  
(10053182)  
Black Nylon  
Push-Type Retainer  
Head Diameter: 19/32" (15mm)  
Stem Length: 13/16" (20.6mm)  
Fits into 5/16" (8mm) Hole  
GM 1987 - On

UNIT PACKAGE: 25



**17103**  
(GM: 15681408;  
Ford: N803709S)  
Black Nylon  
Fascia Retainer  
Head Diameter: 15mm  
Stem Length: 23mm  
Fits into 6mm Hole  
GM & Ford 1986 - On

UNIT PACKAGE: 50



**14992**  
(Ford: N803946S;  
Chrysler: 6502871)  
Black Nylon  
Push-Type Retainer  
Head Diameter: 19/32" (15mm)  
Stem Length: 29/32" (23mm)  
Fits into 1/4" (6.4mm) Hole  
Ford & Chrysler 1987 - On

UNIT PACKAGE: 50

**Sec. 19**

**PUSH-TYPE RETAINERS**

Refer to Retainer Specification Chart on pages 534-545

Listed smallest to largest by Head Diameter, Stem Length and then by Hole Diameter.



**19511**

(W704958-S300)  
White Nylon

Rear Door Lower Trim Panel  
Push-Type Retainer  
Round Head Diameter: 19/32" (15mm)  
Wedge Shaped Head  
Diameter: 29/32" (23mm)  
Stem Length: 11/16" (17.5mm)  
Fits into 3/8" (9.5mm)  
Lincoln Town Car 1998 - On

UNIT PACKAGE: 25



**21969**

(Peugeot & Citroen: 8748.C2)  
Charcoal Gray Nylon

Push-Type Retainer  
Head Diameter: 16mm  
Stem Length: 10mm  
Fits into 6mm Hole  
Peugeot & Citroen

UNIT PACKAGE: 25



**17439**

(90467-09093)  
Black Nylon

Bumper Cover  
Push-Type Retainer  
Head Diameter: 15mm  
Stem Length: 27mm  
Fits into 9mm Hole  
Lexus LS-400

UNIT PACKAGE: 10



**21624**

(90467-10206)  
Black Nylon

Cowl Push-Type Retainer  
Head Diameter: 16mm  
Stem Length: 10mm  
Fits into 8mm Hole  
Lexus ES 350, RX350 & RX 450H and Toyota Camry,  
Sequoia, Tundra & Yaris 2006 - On

UNIT PACKAGE: 15



**19219**

(90467-09096)  
Black Nylon

Front Bumper Push-Type Retainer  
Head Diameter: 15mm  
Stem Length: 27mm  
Fits into 9mm Hole  
Lexus LS400 and Toyota Celica &  
Supra 1989 - On

UNIT PACKAGE: 10



**22083**

(Suzuki: 09409-08327)  
Black Nylon

Front Lights, Cowl &  
Rear Bumper Push-Type Retainer  
Head Diameter: 16mm  
Stem Length: 10mm  
Fits into 8mm Hole  
Suzuki Kizashi, SX4 & XL7 2013 - 02

UNIT PACKAGE: 15



**17226**

(10207146, 21077323)  
Black Nylon

Rear Door Rocker  
Panel to Underbody Bracket  
Push-Type Retainer  
Head Diameter: 15mm  
Stem Length: 29mm  
Fits into 8mm Hole  
GM Saturn 4 Door Models 1991 - On

UNIT PACKAGE: 25



**19243**

(GM: 30008324; Suzuki: 09409-07325)  
Black Nylon

Push-Type Retainer  
Head Diameter: 16mm  
Stem Length: 10mm (Excluding the Pin)  
Fits into 9mm Hole  
Front & Rear Bumper Fascia  
Geo Metro 1989 - On  
Radiator Grille  
Suzuki Esteem 1995 - On

UNIT PACKAGE: 15



**19552**

(90467-07146)  
Black Nylon

Cowl Panel &  
Luggage Compartment Retainer  
Head Diameter: 16mm  
Stem Length: 9mm  
Fits into 7mm Hole

Toyota Avalon, Camry, Celica & Solara 1993 - On

UNIT PACKAGE: 15



**21570**

(909140012)  
Black Nylon

Rear Light Reflector & Roof Spoiler  
Push-Type Retainer  
Head Diameter: 16mm  
Stem Length: 11mm  
Fits into 6mm Hole  
Subaru B9 Tribeca, Impreza,  
Legacy & Outback 2005 - On

UNIT PACKAGE: 25

# PUSH-TYPE RETAINERS

Refer to Retainer Specification Chart on pages 534-545  
Listed smallest to largest by Head Diameter, Stem Length and then by Hole Diameter.



**21044**  
(123-990-05-92, 126-990-03-92)  
Black Nylon  
Cowl Screen Cover  
Push-Type Retainer  
Head Diameter: 16mm  
Stem Length: 11mm  
Fits into 6.3mm Hole  
Mercedes-Benz E, CL & S Class 2000 - On

UNIT PACKAGE: 15



**20310**  
(383142-S)  
Black Nylon  
Grille to Headlight Bracket  
Push-Type Retainer  
Head Diameter: 5/8" (16mm)  
Stem Length: 7/16" (11mm)  
Fits into 1/4" (6.4mm) Hole  
Ford

UNIT PACKAGE: 50



**21859**  
(Mercedes-Benz: 000-990-29-92,  
000-990-60-92; 001-990-16-92,  
114-990-01-92; Opel: 1104882, 1719245;  
Volvo: 9133417, 1268642)  
Black Nylon

Push-Type Retainer  
Head Diameter: 16mm  
Stem Length: 11mm  
Fits into 8mm Hole  
Mercedes-Benz, Opel & Volvo 1985 - On

UNIT PACKAGE: 15



**22234**  
(Ford European: 1257376)  
Black Nylon  
Door Trim Panel Push-Type  
Retainer with Sealer  
Top Head Diameter: 16mm  
Bottom Head Diameter: 18mm  
Stem Length: 11mm  
Fits into 8mm Hole  
Ford Focus & Focus C-Max 2010 - 1998

UNIT PACKAGE: 15



**19306**  
(GA5R-56-392)  
Black Nylon  
Shroud Seal Board Push-Type Retainer  
Head Diameter: 16mm  
Stem Length: 12mm  
Fits into 6mm Hole  
Mazda 626 1994 - On

UNIT PACKAGE: 10



**19297**  
(21035345)  
Black Nylon

Liftgate Upper Window & Lower Garnish  
Moulding Push-Type Retainer  
Head Diameter: 16mm  
Stem Length: 12mm (Excluding the Pin)  
Fits into 7mm Hole  
GM Saturn 1998 - 93

UNIT PACKAGE: 15



**19195**  
(161-867-299-01C)  
Black Nylon

Push-Type Retainer  
Head Diameter: 16mm  
Stem Length: 12mm  
Fits into 8mm Hole  
VW Golf & Jetta 1997 - 93

UNIT PACKAGE: 25



**19607**  
(XL3Z-17E971-AA)  
Natural Nylon

Front Bumper Cover Push-Type Retainer  
Head Diameter: 16mm  
Stem Length: 12mm  
Fits into 10mm Hole  
Ford F150 & F250 Trucks 1999 - On

UNIT PACKAGE: 25



**21566**  
(91085TA030)  
Black Nylon

Push-Type Retainer  
Head Diameter: 16mm  
Stem Length: 13mm  
Fits into 7mm Hole  
Subaru Baja, Impreza,  
Legacy & Outback 2000 - On

UNIT PACKAGE: 25



**22177**  
(Chrysler: 6510766-AA)  
Yellow & White Nylon

Door Panel Push-Type  
Retainer with Sealer  
Top Head Diameter: 16mm  
Middle Head Diameter: 18mm  
Bottom Head Diameter: 22mm  
Stem Length: 13mm  
Fits into 9mm Hole  
Chrysler 300, Dodge Charger &  
Jeep Cherokee 2014 - On

UNIT PACKAGE: 15

**Sec. 19**

**PUSH-TYPE RETAINERS**

Refer to Retainer Specification Chart on pages 534-545

Listed smallest to largest by Head Diameter, Stem Length and then by Hole Diameter.



**21601**

(06509673AA)

White Nylon with Black Rubber Seal

Push-Type Retainer  
 Top Head Diameter: 16mm  
 Middle Head Diameter: 18mm  
 Bottom Head Diameter: 22mm  
 Stem Length: 16mm  
 Fits into 9mm Hole  
 Chrysler 300 & Magnum and Jeep Grand Cherokee & Wrangler 2011 - On

UNIT PACKAGE: 15



**21325**

(90080-46294)

Black Nylon

Turn Signal Light & General Purpose  
 Push-Type Retainer  
 Head Diameter: 16mm  
 Stem Length: 14mm  
 Fits into 7mm Hole  
 Toyota Tundra 2003 - On

UNIT PACKAGE: 10



**15522**

(N805231S)

Black Nylon

Push-Type Retainer  
 Head Diameter: 5/8" (16mm)  
 Stem Length: 17/32" (13.5mm)  
 Fits into 1/4" (6.4mm) Hole  
 Ford Taurus, Topaz & Sable 1989 - On

UNIT PACKAGE: 50



**19904**

(9133417-7)

Black Nylon

Rocker Panel Push-Type Retainer  
 Head Diameter: 16mm  
 Stem Length: 14mm  
 Fits into 9mm Hole  
 Volvo 850 Series 1994 - On

UNIT PACKAGE: 15



**19248**

(1268176-3)

Black Nylon

Bumper Cover Push-Type Retainer  
 Head Diameter: 16mm  
 Stem Length: 14mm  
 Fits into 6mm Hole  
 Volvo 740 & 760 1993 - On

UNIT PACKAGE: 15

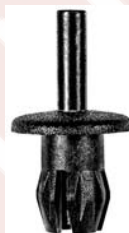

**21971**

(Peugeot & Citroen: 6973.34)

Black Nylon

Push-Type Retainer  
 Head Diameter: 16mm  
 Stem Length: 14mm  
 Fits into 9mm Hole  
 Peugeot & Citroen

UNIT PACKAGE: 25



**21190**

(91550-S50-000ZL)

Black Nylon

Interior Trim Push-Type Retainer  
 Head Diameter: 16mm  
 Stem Length: 14mm  
 Fits into 7mm Hole  
 Honda Civic, CR-V Element  
 & Insight 2000 - On

UNIT PACKAGE: 15



**20909**

(124-990-04-92)

Black Nylon

Push-Type Retainer  
 Head Diameter: 16mm  
 Stem Length: 18mm  
 Fits into 7mm Hole  
 Mercedes-Benz 2003 - On

UNIT PACKAGE: 15

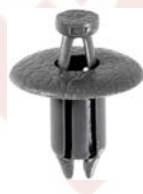

**21477**

(91550-S50-000ZK)

Gray Nylon

Push-Type Retainer  
 Head Diameter: 16mm  
 Stem Length: 14mm  
 Fits into 7mm Hole  
 Honda Civic, CR-V Element & Insight  
 2000 - On

UNIT PACKAGE: 15



**18265**

(76882-57A00)

Black Nylon

Body Side Moulding Push-Type Retainer  
 Head Diameter: 16mm  
 Stem Length: 20mm  
 Fits into 8mm Hole  
 Nissan Sentra 1986 - On

UNIT PACKAGE: 25

# PUSH-TYPE RETAINERS

## Sec. 19

Refer to Retainer Specification Chart on pages 534-545  
Listed smallest to largest by Head Diameter, Stem Length and then by Hole Diameter.



**20352**  
(Honda: 91561-S84-A00-M1,  
91561-S84-A21ZB)  
Black Nylon  
Rear Panel Assembly Push-Type Retainer  
Head Diameter: 16mm  
Stem Length: 21mm  
Fits into 8mm Hole  
Honda Accord & Civic 2007 - 01  
Fit 2014 - 09  
UNIT PACKAGE: 10



**18165**  
(91508-SR3-000)  
Black Nylon  
Cowl Panel  
Push-Type Retainer  
Head Diameter: 17mm  
Stem Length: 9mm  
Fits into 8mm Hole  
Honda 1990 - On  
UNIT PACKAGE: 10



**20542**  
(15994165)  
Black Nylon  
Bumper & Rear Wheel Apron  
Push-Type Retainer  
Head Diameter: 16.5mm  
Stem Length: 27mm  
Fits into 8mm Hole  
Saturn L Series 2000 - On  
UNIT PACKAGE: 25



**17351**  
(MB-253964)  
Black Nylon  
Front & Rear Bumper Push-Type Retainer  
Head Diameter: 17mm  
Stem Length: 10mm  
Fits into 7mm Hole  
Mitsubishi Tredia 1988 - 83  
UNIT PACKAGE: 10



**14011**  
(14019226, 14071289)  
Black Nylon  
Radiator Overflow Bottle/Windshield  
Washer Bottle Retainer  
Head Diameter: 21/32" (16.7mm)  
Stem Length: 9/16" (14.3mm)  
Fits into 5/16" (8mm) Hole  
GM 1981 - On  
UNIT PACKAGE: 25



**20910**  
(91505-ST7-003ZA)  
Black Nylon  
Door Panel Push-Type Retainer  
Head Diameter: 17mm  
Stem Length: 12mm  
Fits into 8mm Hole  
Honda CR-V and S2000 2000 - On  
UNIT PACKAGE: 10



**14001**  
(14039420)  
Black Nylon  
Push-Type Retainer  
Head Diameter: 21/32" (16.7mm)  
Stem Length: 19/32" (15mm)  
Fits into 5/16" (8mm) Hole  
GM (Including Saturn)  
UNIT PACKAGE: 25



**19232**  
(91502-SZ5-003)  
Black Nylon  
Front Fender  
Push-Type Retainer  
Head Diameter: 17mm  
Stem Length: 13mm  
Fits into 7mm Hole  
Acura 3.5 RL Sedan 1996 - On  
UNIT PACKAGE: 10



**18270**  
(90467-07117)  
Black Nylon  
Push-Type Retainer  
Head Diameter: 17mm  
Stem Length: 9mm  
Fits into 7mm Hole  
Lexus 1990 - On  
UNIT PACKAGE: 10



**19547**  
(91508-S50-003)  
Black Nylon  
Cowl Top Retainer  
Head Diameter: 17mm  
Stem Length: 13mm (Excluding the Pin)  
Fits into 9mm Hole  
Honda Accord & Odyssey 1998 - On  
UNIT PACKAGE: 5

**Sec. 19**

**PUSH-TYPE RETAINERS**

Refer to Retainer Specification Chart on pages 534-545

Listed smallest to largest by Head Diameter, Stem Length and then by Hole Diameter.



**15672**  
(8880417)  
Black Nylon

Push-Type Retainer  
Head Diameter: 17mm  
Stem Length: 14mm  
Fits into 8mm (5/16") Hole  
Chrysler 1987 - On

UNIT PACKAGE: 25



**13457**  
(20451119)  
Black Nylon

Front Compartment Spare Tire Retainer  
Head Diameter: 43/64" (17mm)  
Stem Length: 23/32" (18.3mm)  
Fits into 5/16" (8mm) Hole  
GM

UNIT PACKAGE: 10



**19546**  
(91570-SK7-003ZF)  
Black Nylon

Tailgate Lining Retainer  
Head Diameter: 17mm  
Stem Length: 16mm  
Fits into 7mm Square Hole  
Honda Prelude 1997 - On

UNIT PACKAGE: 10



**21898**  
(Renault & Dacia: 77-03-072-352)  
Black Nylon

Push-Type Retainer  
Head Diameter: 17.5mm  
Stem Length: 9mm  
Fits into 6mm Hole  
Renault & Dacia

UNIT PACKAGE: 10



**19639**  
(GM: 15149708;  
Chrysler: 6506008AA)  
Black Nylon

Radiator Wheelhouse, Fender &  
Front Bumper Cover Push-Type Retainer  
Head Diameter: 17mm  
Stem Length: 16mm  
Fits into 6mm Hole  
GM C & K Trucks 1999 - On  
Jeep Liberty 2002 - On

UNIT PACKAGE: 25



**11704**  
(6031383)  
Black Nylon

Grille Retainer  
Head Diameter: 11/16" (17.5mm)  
Stem Length: 7/16" (11mm)  
Fits into 9/32" (7.1mm) Hole  
Chrysler 1978 - On

UNIT PACKAGE: 25



**16624**  
(1636632, 20687704)  
Black Nylon

Front Bumper Fascia  
Push-Type Retainer  
Head Diameter: 17mm  
Shoulder Length: 2mm  
Stem Length: 18mm  
Fits into 9.5mm (3/8") Hole  
Buick Riviera/Reatta 1988 - On

UNIT PACKAGE: 25



**18893**  
(N806322-S)  
Black Nylon

Trim Panel Push-Type Retainer  
Head Diameter: 11/16" (17.5mm)  
Stem Length: 1/2" (12.7mm)  
Fits into 1/4" (6.4mm) Hole  
Ford

UNIT PACKAGE: 15



**14726**  
(63844-01A99)  
Black Nylon

Push-Type Retainer  
Head Diameter: 17mm  
Stem Length: 18mm  
Fits into 8mm Hole  
Nissan

UNIT PACKAGE: 25



**12567**  
(GM: 14019205, 14019206, 16514113;  
Chrysler: 34201621, 6504090)  
Black Nylon

Front Fender Mud Skirt  
& Fender Liner Push-Type Retainer  
Head Diameter: 11/16" (17.5mm)  
Stem Length: 9/16" (14.3mm)  
Fits into 1/4" (6.4mm) Hole  
GM 1981 - On

UNIT PACKAGE: 25

**14007**  
Same as 12567 except unit package quantity  
UNIT PACKAGE: 50



# PUSH-TYPE RETAINERS

Refer to Retainer Specification Chart on pages 534-545  
Listed smallest to largest by Head Diameter, Stem Length and then by Hole Diameter.



**11699**  
(GM: 472434; Chrysler: 6031390)  
Black Nylon

Cowl Ledge Weatherstrip  
& Fender Liner Push-Type Retainer  
Head Diameter: 11/16" (17.5mm)  
Stem Length: 5/8" (16mm)  
Fits into 1/4" (6.4mm)  
GM 1970 - On  
Chrysler 1968 - On

UNIT PACKAGE: 50



**18327**  
(6503454)  
Black Nylon

Front Bumper Fascia  
Push-Type Retainer  
Head Diameter: 11/16" (17.5mm)  
Stem Length: 5/8" (16mm)  
Fits into 1/4" (6.4mm) Hole  
Jeep Grand Cherokee 1994 - On

UNIT PACKAGE: 25



**14991**  
(GM: 10139822, 25680782;  
Ford: N808147S)  
Black Nylon

Push-Type Retainer  
Head Diameter: 11/16" (17.5mm)  
Stem Length: 11/16" (17.5mm)  
Fits into 1/4" (6.4mm) Hole  
GM & Ford 1987 - On

UNIT PACKAGE: 25



**18894**  
(N807578-S, N808332-S)  
Black Nylon

Trim Panel  
Push-Type Retainer  
Head Diameter: 11/16" (17.5mm)  
Stem Length: 3/4" (19mm)  
Fits into 1/4" (6.4mm) Hole  
Ford

UNIT PACKAGE: 15

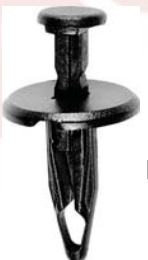

**18030**  
(Chrysler: 6501925;  
GM: 10134407)  
Black Nylon

Push-Type Retainer  
Head Diameter: 11/16" (17.5mm)  
Stem Length: 13/16" (20.6mm)  
Fits into 1/4" (6.4mm) Hole  
Chrysler Concorde & LHS  
Dodge Intrepid & Eagle Vision 1993 - On  
Coolant Recovery Reservoir  
GM 1992 - On

UNIT PACKAGE: 25



**13993**  
(GM: 20510029; Ford: N803362-S;  
Chrysler: 34202672)  
Black Nylon

Body Retainer  
Head Diameter: 11/16" (17.5mm)  
Stem Length: 7/8" (22mm)  
Fits into 1/4" (6.4mm) Hole  
GM 1984 - On and Ford 1984 - On

UNIT PACKAGE: 25



**14753**  
(GM: 15773445, 20452072, 20664092;  
Ford N804570S; Chrysler: 4638136)  
Black Nylon

Radiator Shroud & Trim Retainer  
Head Diameter: 11/16" (17.5mm)  
Stem Length: 7/8" (22mm)  
Fits into 1/4" (6.4mm) Hole  
GM 1982 - On  
Ford 1986 - On  
Chrysler 1998 - On



UNIT PACKAGE: 25



**14993**  
(22538004)  
Black Nylon

Push-Type Retainer  
Head Diameter: 11/16" (17.5mm)  
Stem Length: 7/8" (22mm)  
Fits into 1/4" (6.4mm) Hole  
GM 1987 - On

UNIT PACKAGE: 25



**13996**  
(20452072, 20590899)  
Black Nylon

Exterior Body Retainer  
Head Diameter: 11/16" (17.5mm)  
Stem Length: 7/8" (22mm)  
Fits into 9/32" (7.1mm) Hole  
GM 1984 - On

UNIT PACKAGE: 25



**18895**  
(N807577-S, N808331-S)  
Black Nylon

Trim Panel Push-Type Retainer  
Head Diameter: 11/16" (17.5mm)  
Stem Length: 1-3/32" (28mm)  
Fits into 1/4" (6.4mm) Hole  
Ford Aerostar & Windstar

UNIT PACKAGE: 15

**Sec. 19**

**PUSH-TYPE RETAINERS**

Refer to Retainer Specification Chart on pages 534-545

Listed smallest to largest by Head Diameter, Stem Length and then by Hole Diameter.



**20335**  
(53879-60010)  
Black Nylon

Fender Liner Push-Type Retainer  
Head Diameter: 18mm  
Stem Length: 7mm  
Fits into 7mm Hole  
Toyota Land Cruiser & RAV 4 1998 - On

UNIT PACKAGE: 15



**21024**  
(5R3Z-54310D12-AAA)  
Black Nylon

Trim Panel  
Push-Type Retainer  
Head Diameter: 18mm  
Stem Length: 10mm  
Fits into 6mm Hole  
Ford Mustang 2005 - On

UNIT PACKAGE: 15



**20869**  
(GM: 88970767; Toyota: 90467-10183)  
Black Nylon

Front Fender Liner Push-Type Retainer  
Head Diameter: 18mm  
Stem Length: 7.5mm  
Fits into 7mm Hole  
Toyota Celica, Corolla, Matrix & Solara,  
Lexus and Pontiac Vibe 1999 - On

UNIT PACKAGE: 10



**21530**  
(Subaru: 909130067;  
Hyundai: 86590-3S000)  
Black Nylon

Engine Cover and Fender Liner  
Push-Type Retainer  
Head Diameter: 18mm  
Stem Length: 10mm  
Fits into 8mm Hole  
B9 Tribeca, Forester, Legacy &  
Outback & Tribeca. 2005 - On  
Hyundai Azera, Elantra, Genesis & Sonata and  
Kia Cadenza & Optima 2011 - On

UNIT PACKAGE: 15



**19490**  
(90467-06150)  
Black Nylon

Back Garnish Trim Panel  
Push-Type Retainer  
Head Diameter: 18mm  
Stem Length: 8mm  
Fits into 6mm Hole  
Toyota Tacoma 1995 - On

UNIT PACKAGE: 10



**22181**  
(Subaru: 909140065)  
Black Nylon

Front Fender Liner, Engine Cover,  
Hood & Quarter Panel Push-Type Retainer  
Head Diameter: 18mm  
Stem Length: 10mm  
Fits into 8mm Hole  
Subaru BRZ, Crosstrek, Forester, Impreza,  
Legacy, Outback & WRX 2008 - On

UNIT PACKAGE: 15



**20465**  
(UB39-45-919)  
Black Nylon

Front & Rear Fender  
Push-Type Retainer  
Head Diameter: 18mm  
Stem Length: 9mm  
Fits into 8mm Hole  
Mazda 626 2000 - On

UNIT PACKAGE: 10



**21680**  
(Chrysler: 6509960AA)  
Black Nylon

Bumper Push-Type Retainer  
Head Diameter: 18mm  
Stem Length: 10mm  
Fits into 8mm Hole  
Chrysler 300 2011 - On

UNIT PACKAGE: 25



**22077**  
(Mitsubishi: MB879499)  
Black Nylon

Front Bumper Push-Type Retainer  
Head Diameter: 18mm  
Stem Length: 9mm  
Fits into 9mm Hole  
Mitsubishi Montero 2006 - 01

UNIT PACKAGE: 25



**19747**  
(UB39-50-795)  
Black Nylon

Stone Guard Push-Type Retainer  
Head Diameter: 18mm  
Stem Length: 10mm  
Fits into 8mm Hole  
Mazda MPV 1998 - On

UNIT PACKAGE: 10

# PUSH-TYPE RETAINERS

Refer to Retainer Specification Chart on pages 534-545  
Listed smallest to largest by Head Diameter, Stem Length and then by Hole Diameter.



## 21547

(90467-09185)  
Black Nylon

Front Spoiler & Grille  
Push-Type Retainer  
Head Diameter: 18mm  
Stem Length: 10mm  
Fits into 9mm Hole  
Lexus HS 250h and Toyota Celica,  
Sequoia, Sienna & 4-Runner 1994 - On

UNIT PACKAGE: 25



## 21703

Ford: W716510-S300)  
Black Nylon

Lower Radiator Shield  
Push-Type Retainer  
Head Diameter: 18mm  
Stem Length: 12mm  
Fits into 7mm Hole  
Ford Fusion 2013 - On

UNIT PACKAGE: 10



## 14698

(90688-SB0-003)  
Black Nylon



Push-Type Retainer  
Head Diameter: 18mm  
Stem Length: 11mm  
Fits into 6mm Hole  
Acura & Honda

UNIT PACKAGE: 25

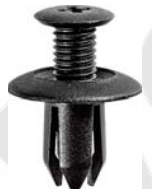

## 17632

(Mazda: B092-51-833;  
Ford: MB-455-56143)  
Black Nylon

Push-Type Retainer  
Head Diameter: 18mm  
Stem Length: 12mm  
Fits into 8mm Hole  
Mazda & Ford Aspire

UNIT PACKAGE: 10



## 16784

(Nissan: 80999-05N07;  
Toyota: 90467-07043)  
Black Nylon

Push-Type Retainer  
Head Diameter: 18mm  
Stem Length: 11mm (Excluding the Pin)  
Fits into 7mm Hole

UNIT PACKAGE: 25

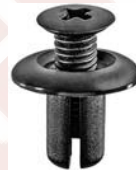

## 21146

(0G032-50037-A)  
Black Nylon

Bumper, Fender, Grille, Interior & Exterior  
Trim and Pillar Push-Type Retainer  
Head Diameter: 18mm  
Stem Length: 12mm  
Fits into 8mm Hole  
Kia Amanti, Magentis, Optima, Rio, Sedona, Sephia,  
Sorento, Spectra & Sportage 2000 - On

UNIT PACKAGE: 15



## 17081

(91524-SE0-003)  
Black Nylon



Cowl Push-Type Retainer  
Head Diameter: 18mm  
Stem Length: 12mm  
Fits into 6mm Hole  
Honda Accord 1986 - On

UNIT PACKAGE: 25



## 21311

(01553-0038U)  
Gray Nylon

Bumper Push-Type Retainer  
Head Diameter: 18mm  
Stem Length: 12mm  
Fits into 8mm Hole  
Nissan Frontier, Pathfinder & Xterra  
2005 - On

UNIT PACKAGE: 10



## 18206

(GJ21-68885-B69)  
Gray Nylon

Push-Type Retainer  
Head Diameter: 18mm  
Stem Length: 12mm  
Fits into 6mm Hole  
Ford Probe & MX6 1989 - On

UNIT PACKAGE: 25



## 20349

(01553-09611)  
Black Nylon

Bumper Clip  
Push-Type Retainer  
Head Diameter: 18mm  
Stem Length: 12mm  
Fits into 8mm Hole  
Nissan Maxima 1994 - On

UNIT PACKAGE: 15

**Sec. 19**

**PUSH-TYPE RETAINERS**

Refer to Retainer Specification Chart on pages 534-545

Listed smallest to largest by Head Diameter, Stem Length and then by Hole Diameter.



**21110**  
(B100-68-8550)  
Black Nylon

Rear Light Access Door  
Push-Type Retainer  
Head Diameter: 18mm  
Stem Length: 12mm  
Fits into 8.5mm Hole  
Mazda 323 1986 - On

UNIT PACKAGE: 15



**21141**  
(91561-SJD-003)  
Black & White Nylon

Pillar, Rocker Panel & Floor Retainer  
Top Head Diameter: 15mm  
Middle Head Diameter: 16mm  
Bottom Head Diameter: 18mm  
Stem Length: 13mm  
Fits into 8mm Hole  
Honda Civic & Pilot 2004 - On

UNIT PACKAGE: 10



**20247**  
(Mitsubishi: MR200300)  
Black Nylon

Fender & Bumper Push-Type Retainer  
Head Diameter: 18mm  
Stem Length: 12mm  
Fits into 9mm Hole  
Honda & Mitsubishi 1998 - On

UNIT PACKAGE: 15



**21858**  
(Mazda: B467-68-AC3-02)  
Black Nylon

Rear Trunk Liner Push-Type Retainer  
Head Diameter: 18mm  
Stem Length: 14mm  
Fits into 6mm Hole  
5, CX-7, CX-9, Miata, Millenia, MX-6,  
RX-7 & Protégé 1993 - On

UNIT PACKAGE: 25



**21702**  
(Toyota: 90467-10170-C0)  
Black Nylon

Cowl Vent, Upper Radiator Cover &  
Wheel Apron Push-Type Retainer  
Head Diameter: 18mm  
Stem Length: 12mm  
Fits into 10mm Hole  
Lexus LS 460, LS 600, RX 350  
& RX 450 and Toyota RAV4 2006 - On

UNIT PACKAGE: 10



**21225**  
(53888-48010)  
Black Nylon

Wheel Opening Push-Type Retainer  
Head Diameter: 18mm  
Stem Length: 14mm  
Fits into 7mm Hole  
Toyota Highlander 2001 - On

UNIT PACKAGE: 5



**20365**  
(10301966, 10425306)  
Black Nylon

Cowl Vent Push-Type Retainer  
Head Diameter: 18mm  
Stem Length: 13mm  
Fits into 7.5mm Square Hole  
Pontiac Aztek 2001 - On

UNIT PACKAGE: 10



**17192**  
(91508-SM4-003)  
Black Nylon

Cowl Panel Push-Type Retainer  
Head Diameter: 18mm  
Stem Length: 14mm  
Fits into 8mm Hole  
Honda Accord 1990 - On

UNIT PACKAGE: 10



**21807**  
(Renault: 77-03-072-360)  
Black Nylon

Push-Type Retainer  
Head Diameter: 18mm  
Stem Length: 14mm  
Fits into 8mm Hole  
Renault and Dacia

UNIT PACKAGE: 25



**22253**  
(Hyundai: 86595-2T500)  
Black Nylon

Fender Liner Push-Type Retainer  
Head Diameter: 18mm  
Stem Length: 14mm  
Fits into 8mm Hole  
Hyundai Equus, Genesis, Santa Fe &  
Sonata and Kia K900, Optima & Sedona  
2013 - On

UNIT PACKAGE: 15

# PUSH-TYPE RETAINERS

## Sec. 19

Refer to Retainer Specification Chart on pages 534-545

Listed smallest to largest by Head Diameter, Stem Length and then by Hole Diameter.



**19453**  
(90505-SX0-003)  
Black Nylon

Garnish Side Protector  
Push-Type Retainer  
Head Diameter: 18mm  
Stem Length: 15mm  
(Excluding the Pin)  
Fits into 8mm Hole  
Honda Odyssey 1995 - On

UNIT PACKAGE: 15



**19416**  
(Toyota: 90467-09139)  
Black Nylon

Bumper Cover & Wheel Housing  
Push-Type Retainer  
Head Diameter: 18mm  
Stem Length: 15mm  
Fits into 9mm Hole  
Honda, Mazda 626 & Toyota Corolla 1992 - On

UNIT PACKAGE: 15



**19246**  
(01553-09241)  
Black Nylon

Bumper Push-Type Retainer  
Head Diameter: 18mm  
Stem Length: 15mm  
Fits into 10mm Hole  
Nissan 240SX & Maxima 1994 - On

UNIT PACKAGE: 15



**19231**  
(91505-SL0-003)  
Black Nylon

Push-Type Retainer  
Head Diameter: 18mm  
Stem Length: 12mm  
Fits into 8mm Hole  
Acura NSX 1991 - On

UNIT PACKAGE: 15



**20988**  
(GM: 11589289;  
Chrysler: 6508863-AA)  
Black Nylon

Air Distributor & Windshield Defroster  
Push-Type Retainer  
Head Diameter: 18mm  
Stem Length: 17.5mm  
Panel Range: 2.0mm - 4.5mm  
Fits into 6.5mm Hole  
Buick Enclave, Chevrolet Equinox,  
Chevrolet & GMC S & T Trucks, GMC  
Acadia and Pontiac Torrent 2002 - On

UNIT PACKAGE: 25



**16726**  
(N808048S, W705532-S300)  
Black Nylon

Front Bumper Stone Deflector Retainer  
Head Diameter: 18mm  
Stem Length: 18mm  
Fits into 6.3mm (1/4") Square Hole  
Ford Bronco, Ranger & Explorer 1989 - On

UNIT PACKAGE: 25



**20545**  
(N811283-S)  
Black Nylon & Santoprene Rubber

Trim Panel Push-Type Retainer  
Head Diameter: 18mm  
Stem Length: 18mm  
Fits into 6.3mm Hole  
Ford Expedition & Navigator 1997 - On

UNIT PACKAGE: 25



**21098**  
(Chrysler: 6508197-AA;  
Ford: W706092-S300)  
Black Nylon

Front Air Shield, Splash Guard &  
Heat Shield Push-Type Retainer  
Head Diameter: 18mm  
Stem Length: 18mm  
Fits into 6.4mm Hole  
Dodge Ram 2006 - On  
Ford Taurus 2008 - On

UNIT PACKAGE: 25



**22354**  
(Chrysler: 6510139-AA)  
Black Nylon

Exterior Trim,  
Floor, Pillar &  
Quarter Panel Push-Type Retainer  
Head Diameter: 18mm  
Stem Length: 18mm  
Fits into 7mm Hole  
Dodge Challenger & Charger 2011 - On

UNIT PACKAGE: 25



**21089**  
(W710250-S300)  
Black Nylon

Rear Bumper Push-Type Retainer  
Head Diameter: 18mm  
Stem Length: 18mm  
Fits into 8mm Hole  
Ford Edge 2007 - On

UNIT PACKAGE: 25

**Sec. 19**

**PUSH-TYPE RETAINERS**

Refer to Retainer Specification Chart on pages 534-545

Listed smallest to largest by Head Diameter, Stem Length and then by Hole Diameter.



**20367**  
(W706713-S300)  
Black Nylon

Bumper Cover  
Push-Type Retainer  
Head Diameter: 18mm  
Stem Length: 18mm  
Fits into 8mm Hole  
Ford Escape 2001 - On

UNIT PACKAGE: 25



**20880**  
(GM:11589290; Chry.: 6509049AA)  
Black Nylon

Air Inlet Grille, Bumper Fascia &  
Front Brake Caliper Cooling Duct  
Push-Type Retainer  
Head Diameter: 18mm  
Stem Length: 20mm  
Panel Range: 4.5mm - 7.0mm  
Fits into 6.5mm Hole  
Buick Enclave, Cadillac, CTS & STS,  
Chevrolet Cobalt, Equinox & SSR, GM Trucks and  
Pontiac G5 & Torrent 2002 - On  
Chrysler Charger & 300 2011 - On

UNIT PACKAGE: 50



**19849**  
(Not Available from O.E.M.)  
Black Nylon & Santoprene Rubber

Bumper Push-Type Retainer  
Head Diameter: 18mm  
Stem Length: 18mm  
Fits into 8mm Hole  
Ford Taurus & Sable 2000 - On

UNIT PACKAGE: 25



**22227**  
(Ford: W718088-S300)  
Black Nylon

Fender Apron  
Push-Type Retainer  
Head Diameter: 18mm  
Stem Length: 20mm  
Fits into 7mm Hole  
Ford Fusion 2015 - On

UNIT PACKAGE: 25



**21876**  
(Renault & Dacia: 05-40-000-1R;  
Nissan: 01515-00Q0C)  
Black Nylon

Bumper Push-Type Retainer  
Head Diameter: 18mm  
Stem Length: 18mm  
Fits into 9mm Hole  
Renault, Dacia & Nissan

UNIT PACKAGE: 15



**20966**  
(5160260-AA)  
Black Nylon

Rear Bumper, Tail Light &  
Fender Push-Type Retainer  
Bottom Head Diameter: 18mm  
Stem Length: 20mm  
Fits into 8mm Hole  
Dodge Caliber and Jeep  
Compass & Patriot 2007 - On

UNIT PACKAGE: 15



**21123**  
(75867-30120)  
Black Nylon

Rocker Moulding Push-Type Retainer  
Head Diameter: 18mm  
Stem Length: 19mm  
Fits into 8mm Hole  
Lexus GS350, GS430, GS460 & LS460  
and Toyota Camry 2007 - On

UNIT PACKAGE: 15



**20613**  
(63848-40Y00)  
Black Nylon

Front Bumper Push-Type Retainer  
Head Diameter: 18mm  
Stem Length: 20mm  
Fits into 9mm Hole  
Nissan Frontier & Xterra 1998 - On

UNIT PACKAGE: 15



**21672**  
(11611110)  
Black Nylon

Cowl Vent Push-Type  
Retainer with Sealer  
Head Diameter: 18mm  
Stem Length: 20mm  
Fits into 6.3mm Hole  
Buick Allure & LaCrosse and  
Chevrolet Volt 2010 - On

UNIT PACKAGE: 15



**22049**  
(Mazda: B27K-51-PS7)  
Black Nylon

Headlight Bracket Push-Type Retainer  
Head Diameter: 18mm  
Stem Length: 20mm  
Fits into 9mm Hole  
Mazda 3, CX-7, CX-9, Miata, MPV & RX-8  
2000 - On

UNIT PACKAGE: 15

# PUSH-TYPE RETAINERS

## Sec. 19

Refer to Retainer Specification Chart on pages 534-545  
Listed smallest to largest by Head Diameter, Stem Length and then by Hole Diameter.



### 20888

(GM: 11561368;  
Chrysler: 6508712AA)  
Black Nylon

Fender, Wheel & Bumper  
Push-Type Retainer  
Head Diameter: 18mm  
Stem Length: 20mm  
Panel Range: 3.0mm - 5.8mm  
Fits into 9.5mm Hole  
Chevrolet Impala & Monte Carlo and  
Pontiac Grand Prix & Solstice 2004 - On  
Jeep Wrangler 2000 - On

UNIT PACKAGE: 25



### 17057

(90505-SM4-003)  
Black Nylon

Push-Type Retainer  
Head Diameter: 18mm  
Stem Length: 21mm  
Fits into 8mm Hole  
Honda Accord 1990 - On

UNIT PACKAGE: 10



### 20989

(GM: 11589291;  
Ford: W713331-S300)  
Black Nylon

Air Dam & Grille Push-Type Retainer  
Head Diameter: 18mm  
Stem Length: 22mm  
Panel Range: 7.0mm - 9.5mm  
Fits into 6.5mm Hole  
Cadillac CTS, SRX, and STS 2003 - On

UNIT PACKAGE: 25



### 21529

(95230842)  
Black Nylon

Cowl Vent Push-Type  
Retainer with Sealer  
Head Diameter: 18mm  
Stem Length: 22mm  
Fits into 6.5mm Hole  
Chevrolet Cruze 2011 - On

UNIT PACKAGE: 15



### 20327

(63848-9E001)  
Black Nylon

Bumper Fascia Push-Type Retainer  
Head Diameter: 18mm  
Stem Length: 22mm  
Fits into 9mm Hole  
Nissan Altima 1997 - On

UNIT PACKAGE: 10



### 14018

(N803716-S)  
Black Nylon

Fascia Retainer  
Head Diameter: 18mm  
Stem Length: 23mm  
Fits into 7mm Hole  
Ford Mustang/Capri 1985 - On

UNIT PACKAGE: 25



### 22219

(GM: 92138636)  
Black Nylon

Air Baffle Push-Type Retainer  
Head Diameter: 18mm  
Stem Length: 23mm  
Fits into 7.5mm Hole  
Chevrolet Caprice 2013 - 2012  
Pontiac G8 and GTO 2009 - 2004

UNIT PACKAGE: 25



### 18939

(90467-09101)  
Black Nylon

Bumper Cover  
Push-Type Retainer  
Head Diameter: 18mm  
Stem Length: 23mm  
Fits into 9mm Hole  
Lexus ES300 1993 - On

UNIT PACKAGE: 25



### 16622

(10157900,  
11517803, 15993201)  
Black Nylon

Front Bumper Fascia Retainer  
Head Diameter: 18mm  
Stem Length: 23mm  
Fits into 9.5mm (3/8") Hole  
Olds Cutlass 1990 - On  
GM Lt. Truck 1996 - On

UNIT PACKAGE: 25



### 20631

(11588988)  
Black Nylon

Front Bumper Cover Push-Type Retainer  
Head Diameter: 18mm  
Stem Length: 26mm  
Fits into 10mm Hole  
Pontiac Grand Prix 2004 - On

UNIT PACKAGE: 25

**Sec. 19**

**PUSH-TYPE RETAINERS**

Refer to Retainer Specification Chart on pages 534-545

Listed smallest to largest by Head Diameter, Stem Length and then by Hole Diameter.



**20359**  
(11519444)  
Black Nylon

Bumper Cover Push-Type Retainer  
Head Diameter: 18mm  
Stem Length: 26mm  
Fits into 10mm Hole  
Oldsmobile Intrigue, Pontiac Aztek &  
Grand Prix 1997 - On

UNIT PACKAGE: 25



**20768**  
(4806240AA)  
Black Nylon

Rear Bumper Push-Type Retainer  
Large Head Diameter: 18.5mm  
Stem Length: 21mm  
Fits into 8mm Hole  
Chrysler 300 & Dodge Magnum  
2005 - On

UNIT PACKAGE: 10



**18873**  
(52161-16010, 52161-02020)  
Black Nylon

Rear Bumper Cover  
Push-Type Retainer  
Head Diameter: 18mm  
Stem Length: 28mm  
Fits into 9mm Hole  
Toyota Tercel 1988 - On

UNIT PACKAGE: 6



**21201**  
(90467-07211)  
Black Nylon

Bumper, Radiator Cover &  
Grille Push-Type Retainer  
Head Diameter: 19mm  
Stem Length: 8mm  
Fits into 7mm Hole  
Lexus IS & LS, Scion and Toyota Avalon,  
Camry & Highlander 2005 - On

UNIT PACKAGE: 10



**20931**  
(52161-20010)  
Black Nylon

Bumper Cover & Grille  
Push-Type Retainer  
Head Diameter: 18mm  
Stem Length: 31mm  
Fits into 9mm Hole  
Toyota 2000 - On

UNIT PACKAGE: 15



**21525**  
(53259-0E010)  
Black Nylon

Front Inner Structure Push-Type Retainer  
Head Diameter: 19mm  
Stem Length: 9mm  
Fits into 7mm Hole  
Lexus EX 350, IS 250, IS 350, RX 330,  
RX350 and RX 400H 2004 - On

UNIT PACKAGE: 15



**19422**  
(6504521)  
Black Nylon

Fascia Push-Type Retainer  
Head Diameter: 23/32" (18.3mm)  
Stem Length: 29/32" (23mm)  
Fits into 5/16" (8mm) Hole  
Chrysler LHS, Concorde, Intrepid &  
Eagle Vision 1998 - On

UNIT PACKAGE: 25



**22248**  
(Land Rover: DYQ500060)  
Black Nylon

Exterior Pillar Moulding  
Push-Type Retainer  
Top Head Diameter: 19mm  
Bottom Head Diameter: 13mm  
Stem Length: 12mm  
Fits into 8mm Hole  
Range Rover Sport 2012 - 2006

UNIT PACKAGE: 25



**21479**  
(701-867-299)  
Gray Nylon

Front Bumper & Interior Trim  
Push-Type Retainer  
With 3mm Allen Head Drive  
Head Diameter: 18.5mm  
Stem Length: 11mm  
Fits into 9mm Hole  
VW Jetta & Passat 1999 - On

UNIT PACKAGE: 25



**13469**  
(N802737-S)  
Black Nylon

Under Hood Retainer  
Head Diameter: 3/4" (19mm)  
Stem Length: 1/2" (12.7mm)  
Fits into 1/4" (6.4mm) Hole  
Ford Tempo & Topaz

UNIT PACKAGE: 25



# PUSH-TYPE RETAINERS

Refer to Retainer Specification Chart on pages 534-545  
Listed smallest to largest by Head Diameter, Stem Length and then by Hole Diameter.



**20826**  
(11609417)  
Black Nylon

Fender Apron Push-Type Retainer  
Head Diameter: 19mm  
Stem Length: 14mm  
Panel Range: 2.7mm - 5.3mm  
Fits into 8.5mm Hole

Buick Enclave & LaCrosse, Cadillac CTS, SRX & STS,  
Chevrolet Cobalt, Equinox & Malibu, GM Trucks and  
Pontiac G5, G6 & Torrent 2003 - On

UNIT PACKAGE: 50



**17988**  
(90467-09143)  
Black Nylon

Push-Type Retainer  
Head Diameter: 19mm  
Stem Length: 26mm  
Fits into 9mm Hole  
Lexus 1990 - On

UNIT PACKAGE: 10



**20990**  
(GM: 15296830;  
Chrysler: 5116530-AA)  
Black Nylon

Fascia & General Purpose  
Push-Type Retainer  
Head Diameter: 19mm  
Stem Length: 16mm  
Panel Range: 5.0mm - 7.0mm  
Fits into 8mm Hole  
GM 2007 - On

UNIT PACKAGE: 25



**22126**  
(Toyota: 53384-68010)  
Black Nylon

Front Grille Push-Type Retainer  
Rubber Head Diameter: 19mm  
Bottom Head Diameter: 18mm  
Stem Length: 28mm  
Fits into 9mm Hole  
Scion tC & Toyota RAV4 2005 - On

UNIT PACKAGE: 15



**11706**  
(387944-S)  
Black Nylon

Grille to Metal Stamping Retainer  
Head Diameter: 3/4" (19mm)  
Shoulder Length: 1/4" (6.4mm)  
Stem Length: 11/16" (17.5mm)  
Fits into 1/4" (6.4mm) Wide Slot  
Ford Truck 1978 - On

UNIT PACKAGE: 50



**19245**  
(5BB14LX9)  
Black Nylon

Fascia to Front Bumper  
Push-Type Retainer  
Top Head Diameter: 3/4" (19mm)  
Stem Length: 1-1/8" (28.5mm)  
Fits into 1/4" (6.4mm) Hole  
Dodge Dakota 1994 - On

UNIT PACKAGE: 25



**20273**  
(Ford: N808791;  
Chrysler: 5GC71RC3AA, 5GF92RC3AA)  
Gray Nylon

Interior Trim, Dash & Console  
Push-Type Retainer  
Head Diameter: 19mm  
Shoulder Diameter: 10mm  
Shoulder Length: 7mm  
Stem Length: 22mm  
Fits into 9mm Hole  
Dodge Durango &  
Ford Pick-Ups 1997 - On

UNIT PACKAGE: 25



**18308**  
(3540858)  
Black Nylon

Radiator Air Baffle  
Push-Type Retainer  
Large Head  
Diameter: 3/4" (19mm)  
Stem Length: 1-1/8" (28.5mm)  
Fits into 1/4" (6.4mm) Hole  
Cadillac Eldorado & Seville 1993 - On

UNIT PACKAGE: 25

**Sec. 19**

**PUSH-TYPE RETAINERS**

Refer to Retainer Specification Chart on pages 534-545

Listed smallest to largest by Head Diameter, Stem Length and then by Hole Diameter.



**20244**  
(25707329)  
Green Nylon

Push-Type Retainer with Sealer  
Head Diameter: 19mm  
Stem Length: 32mm  
Fits into 8mm Hole  
Buick LeSabre, Oldsmobile Aurora  
& Pontiac Bonneville 2000 - On

UNIT PACKAGE: 10



**19907**  
(90467-07121-B2)  
Nylon

Door Trim Panel  
Push-Type Retainer  
Head Diameter: 20mm  
Stem Length: 8mm (Excluding the Pin)  
Fits into 7mm Hole  
Toyota RAV4 1997 - On

UNIT PACKAGE: 10



**20755**  
(GD7A-50-EA1)  
Black Nylon

Bumper Cover & Grille  
Push-Type Retainer  
Head Diameter: 19.5mm  
Stem Length: 15mm  
Fits into 10mm Hole  
Mazda 1999 - On

UNIT PACKAGE: 10



**18888**  
(90467-07166)  
Black Nylon

Front Fender Liner Push-Type Retainer  
Head Diameter: 20mm  
Stem Length: 8mm (Excluding the Pin)  
Fits into 7mm Hole  
Toyota Tercel 1994 - On

UNIT PACKAGE: 15



**21568**  
(57160FC000)  
Black Nylon

Front Fender Push-Type Retainer  
Top Head Length: 19.5mm  
Bottom Head Diameter: 14mm  
Stem Length: 15mm  
Fits into 10mm Hole  
Subaru Forester 2008 - 1998

UNIT PACKAGE: 25



**21631**  
(84995-35101)  
Black Nylon

Push-Type Retainer  
Head Diameter: 20mm  
Stem Length: 8mm (Excluding the Pin)  
Fits into 8mm Hole  
Nissan Sentra 2007 - On

UNIT PACKAGE: 15



**20577**  
(GM: 88970494, 88973676;  
Toyota: 90467-07168)  
Black Nylon

Rocker Panel & Garnish Moulding  
Push-Type Retainer  
Head Diameter: 20mm  
Stem Length: 8mm (Excluding the Pin)  
Fits into 7mm Hole  
Pontiac Vibe 2003 - On  
Lexus & Toyota 2000 - On

UNIT PACKAGE: 15



**19905**  
(01553-10051)  
Black Nylon

Push-Type Retainer  
Head Diameter: 20mm  
Stem Length: 8mm (Excluding the Pin)  
Fits into 8mm Hole  
Nissan Maxima 1999 - On

UNIT PACKAGE: 15



**19908**  
(90467-07121)  
Black Nylon

Door Trim Panel  
Push-Type Retainer  
Head Diameter: 20mm  
Stem Length: 8mm (Excluding the Pin)  
Fits into 7mm Hole  
Toyota RAV4 1997 - On

UNIT PACKAGE: 10



**14369**  
(1395-68-676, 9926-50-635)  
Black Nylon

Push-Type Retainer  
Head Diameter: 20mm  
Stem Length: 9mm  
Fits into 6mm Hole  
Mazda

UNIT PACKAGE: 15

**PUSH-TYPE RETAINERS**

Refer to Retainer Specification Chart on pages 534-545  
Listed smallest to largest by Head Diameter, Stem Length and then by Hole Diameter.



**19128**

(90467-07044)  
Black Nylon

Quarter Panel Wheel Opening  
Moulding Push-Type Retainer  
Head Diameter: 20mm  
Stem Length: 9mm  
Fits into 7mm Hole  
Toyota T-100 1992 - On

UNIT PACKAGE: 10



**19315**

(BC1D-56-145)  
Black Nylon

Mud Guard Push-Type Retainer  
Head Diameter: 20mm  
Stem Length: 9mm (Excluding the Pin)  
Fits into 8mm Hole  
Mazda Protege 1996 - On

UNIT PACKAGE: 15



**21294**

(90467-07214)  
Black Nylon

Radiator Splash Shield  
Push-Type Retainer  
Head Diameter: 20mm  
Stem Length: 9mm  
Fits into 7mm Hole  
Toyota Camry 2007 - On

UNIT PACKAGE: 25



**17379**

(91512-SM4-003)  
Black Nylon

Fender Splash Shield  
Push-Type Retainer  
Head Diameter: 20mm  
Stem Length: 9mm  
Fits into 8mm Hole  
Honda Accord 1990 - On

UNIT PACKAGE: 10



**20270**

(51-48-1-938-725)  
Black Nylon

Hood & Trunk Insulation  
Push-Type Retainer  
Head Diameter: 20mm  
Stem Length: 9mm  
Fits into 7mm Hole  
BMW Series 3, 5, & 7 2001 - 84

UNIT PACKAGE: 25



**20637**

(123-990-02-92)  
Black Nylon

Push-Type Retainer  
Head Diameter: 20mm  
Stem Length: 9mm  
Fits into 8mm Hole  
Mercedes-Benz

UNIT PACKAGE: 10



**21422**

(909140051)  
Black Nylon

Front Bumper & Quarter Panel  
Push-Type Retainer  
Head Diameter: 20mm  
Stem Length: 9mm (Excluding the Pin)  
Fits into 7mm Hole  
Subaru Impreza, Legacy,  
Outback & Tribeca 2005 - On

UNIT PACKAGE: 15



**19274**

(01553-09321)  
Black Nylon

Push-Type Retainer  
Head Diameter: 20mm  
Stem Length: 9mm (Excluding the Pin)  
Fits into 8mm Hole  
Nissan Maxima & 300ZX 1994 - On

UNIT PACKAGE: 15



**16000**

(Honda: 90675-SB3-003;  
Mazda: FB01-56-964;  
Nissan: 63876-95596)  
Black Nylon

Push-Type Retainer  
Head Diameter: 20mm  
Stem Length: 9mm  
Fits into 8mm Hole  
Honda, Mazda & Nissan

UNIT PACKAGE: 25



**21010**

(90467-09166)  
Black Nylon

Push-Type Retainer  
Head Diameter: 20mm  
Stem Length: 9mm  
Fits into 9mm Square Hole  
Toyota Camry 2006 - On

UNIT PACKAGE: 15

**Sec. 19**

**PUSH-TYPE RETAINERS**

Refer to Retainer Specification Chart on pages 534-545

Listed smallest to largest by Head Diameter, Stem Length and then by Hole Diameter.



**21973**  
(Peugeot & Citroen: 1539.16)  
Tan Nylon

Push-Type Retainer  
Head Diameter: 20mm  
Stem Length: 10mm  
Fits into 6mm Hole  
Peugeot & Citroen

UNIT PACKAGE: 10



**21651**  
(91501-TR0-003)  
Black Nylon

Fender Push-Type Retainer  
Head Diameter: 20mm  
Stem Length: 10mm  
Fits into 8mm Hole  
Honda Civic 2012 - On

UNIT PACKAGE: 25



**20908**  
(90467-07164)  
Black Nylon

Fender Splash Shield  
Push-Type Retainer  
Head Diameter: 20mm  
Stem Length: 10mm  
Fits into 7mm Hole  
Toyota Camry, Echo, MR2 &  
Sienna 1997 - On

UNIT PACKAGE: 10



**21086**  
(203-990-01-92)  
Black Nylon

Hood Insulation Push-Type Retainer  
Head Diameter: 20mm  
Stem Length: 10mm  
Fits into 8mm Hole  
Mercedes-Benz GL, M, R, SL & SLK  
2005 - On

UNIT PACKAGE: 15



**21571**  
(59122FA010)  
Black Nylon

Front Bumper, Fender,  
Windshield Washer & Rocker  
Moulding Push-Type Retainer  
Head Diameter: 20mm  
Stem Length: 10mm  
Fits into 8mm Hole  
Subaru B9 Tribeca, Baja, Forester,  
Impreza, Legacy & Outback 1998 - On

UNIT PACKAGE: 25



**22306**  
(Mercedes: 000-991-49-40-M58)  
Black Nylon

Lower Engine Cover, Interior Trim &  
Trunk Cover Liner Push-Type Retainer  
Head Diameter: 20mm  
Stem Length: 10mm  
Fits into 8mm Hole  
Mercedes-Benz C300, C400, C63,  
CLS400, CLS550, CLS63, GLK250,  
GLK350, S550, S63 & S65 2015 - On

UNIT PACKAGE: 15



**22270**  
(Subaru: 909140068)  
Black Nylon

Front Fender Push-Type Retainer  
Head Diameter: 20mm  
Stem Length: 10mm  
Fits into 8mm Hole  
Subaru BRZ, Impreza, Legacy,  
Outback & XV Crosstrek 2012 - On

UNIT PACKAGE: 15



**21811**  
(Peugeot & Citroen: 8211.WV)  
Black Nylon

Push-Type Retainer  
Head Diameter: 20mm  
Stem Length: 10mm  
Fits into 8mm Hole  
Peugeot & Citroen

UNIT PACKAGE: 25



**19118**  
(91501-S04-003)  
Black Nylon

Front Fender Push-Type Retainer  
Head Diameter: 20mm  
Stem Length: 10mm  
Fits into 8mm Hole  
Honda Civic & Del Sol 1993 - On

UNIT PACKAGE: 15



**21594**  
(909130051)  
Black Nylon

Fender Liner, Duct & Lower  
Moulding Push-Type Retainer  
Head Diameter: 20mm  
Stem Length: 11mm  
Fits into 7mm Hole  
Subaru B9 Tribeca, Forester,  
Impreza, Legacy & Outback 2005 - On

UNIT PACKAGE: 15

# PUSH-TYPE RETAINERS

## Sec. 19

Refer to Retainer Specification Chart on pages 534-545  
Listed smallest to largest by Head Diameter, Stem Length and then by Hole Diameter.



**21592**  
(909140052)  
Black Nylon

Push-Type Retainer  
Head Diameter: 20mm  
Stem Length: 11mm  
Fits into 7mm Hole  
Subaru B9 Tribeca, Impreza,  
Legacy & Outback 2005 - On

UNIT PACKAGE: 15



**21580**  
(59122AC030)  
Black Nylon

Front Fender Push-Type Retainer  
Head Diameter: 20mm  
Stem Length: 12mm  
Fits into 7mm Hole  
Subaru B9 Tribeca, Baja, Forester Legacy  
& Outback 1995 - On

UNIT PACKAGE: 25



**19239**  
(Honda: 91512-SX0-003;  
Mitsubishi: MU000319)  
Black Nylon

Front Fender & Bumper Support  
Push-Type Retainer  
Head Diameter: 20mm  
Stem Length: 11mm  
Fits into 8mm Hole  
Acura 3.5RL, Honda Accord,  
Prelude & Odyssey 1994 - On  
Mitsubishi Lancer 2002 - On

UNIT PACKAGE: 25



**21500**  
(909140063)  
Black Nylon

Cowl Vent Push-Type Retainer  
Head Diameter: 20mm  
Stem Length: 12mm  
Fits into 7mm Hole  
Subaru Legacy & Outback 2010 - On

UNIT PACKAGE: 10



**17347**  
(01553-06721)  
Black Nylon

Front & Rear Bumper  
Cover Push-Type Retainer  
Head Diameter: 20mm  
Stem Length: 11mm (Excluding the Pin)  
Fits into 8mm Hole  
Nissan Maxima & Infiniti 1990 - On

UNIT PACKAGE: 15

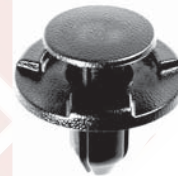

**21192**  
(Nissan: 01553-05323)  
(Mazda: L33X13209)  
Black Nylon

Cowl, Bumper & Fender Liner  
Push-Type Retainer  
Head Diameter: 20mm  
Stem Length: 12mm  
Fits into 8mm Hole  
Infiniti FX35, FX45, G35 and Nissan 2003 - On  
Mazda 2, 3, 5, 6, CX-5, CX-7 & CX-9 2007 - On

UNIT PACKAGE: 10



**21297**  
(91503-S7A-003)  
Black Nylon

Front Bumper Push-Type Retainer  
Head Diameter: 20mm  
Stem Length: 11mm  
Fits into 10mm Hole  
Honda Civic 2010 - On

UNIT PACKAGE: 15



**22039**  
(Nissan: 01553-2DR9A)  
Black Nylon

Push-Type Retainer  
Top Head Diameter: 16mm x 19mm  
Bottom Head Diameter: 20mm  
Stem Length: 12mm  
Fits into 8mm Hole  
Infiniti G20, JX35, Q45 & QX60 and  
Nissan Frontier, Maxima, NV, Pathfinder,  
Sentra, Versa & Xterra 2002 - On

UNIT PACKAGE: 15



**17992**  
(90467-07138)  
Black Nylon

Push-Type Retainer  
Head Diameter: 20mm  
Stem Length: 12mm  
Fits into 7mm Hole  
Lexus 1990 - On

UNIT PACKAGE: 10



**21856**  
(Toyota: 51454-48010, 51454-0E010)  
Black Nylon

Front Bumper Extension Mounting  
Bracket Push-Type Retainer  
Head Diameter: 20mm  
Stem Length: 12mm  
Fits into 10mm Hole  
Lexus IS CV, F, RX330 & RX400 Hybrid 2006 - On  
Toyota Highlander, Sienna & Venza 2009 - On

UNIT PACKAGE: 15

**Sec. 19**

**PUSH-TYPE RETAINERS**

Refer to Retainer Specification Chart on pages 534-545

Listed smallest to largest by Head Diameter, Stem Length and then by Hole Diameter.



**22100**  
(GM: 11612035)  
Black Nylon

Front Fender &  
Body Side Liner  
Push-Type Retainer  
Head Diameter: 20mm  
Stem Length: 12mm  
Fits into 8.5mm Hole  
Chevrolet Colorado & SS and  
GMC Canyon 2014 - On

UNIT PACKAGE: 25



**22112**  
(Honda: 91512-STK-A01)  
Black Nylon

Garnish & Rear Spoiler  
Push-Type Retainer with Sealer  
Head Diameter: 20mm  
Stem Length: 13mm  
Fits into 8.5mm Hole  
Acura RDX & TSX and Honda Accord,  
CR-V & Odyssey 2011 - On

UNIT PACKAGE: 10



**20953**  
(11296-AG000)  
Black Nylon

Front Bumper & Radiator Support  
Push-Type Retainer  
Head Diameter: 20mm  
Stem Length: 13mm  
Fits into 8mm Hole  
Infiniti FX 35/45 and Nissan Altima,  
Maxima & Quest 2002 - On

UNIT PACKAGE: 25



**22068**  
(Honda: 91513-SJK-003)  
White Nylon

Rocker, Pillars, Spoiler, Garnish & Exterior  
Trim Push-Type Retainer with Sealer  
Head Diameter: 20mm  
Stem Length: 13mm  
Fits into 8.5mm Hole  
Acura MDX, RLX, TSX & ZDX and Honda  
Accord, Civic, CR-V, Element,  
Fit, Insight & Pilot 2007 - On

UNIT PACKAGE: 15



**22069**  
(Honda: 91512-SJK-003)  
White Nylon

Rocker, Pillars, Garnish & Exterior Trim  
Push-Type Retainer with Sealer  
Head Diameter: 20mm  
Stem Length: 13mm  
Fits into 8.5mm Hole  
Acura ZDX 2013 - 2010  
Honda Odyssey & Pilot 2005 - On

UNIT PACKAGE: 15



**20516**  
(W706182-S300)  
Black Nylon

Headlight Mounting &  
Deck Lid Push-Type Retainer  
Head Diameter: 20mm  
Hex: 10mm  
Stem Length: 13mm  
Fits into 8mm Hole  
Ford Expedition, Explorer &  
Focus 2000 - On

UNIT PACKAGE: 25



**20986**  
(91505-S9A-003)  
Black Nylon

Front Bumper Push-Type Retainer  
with Internal Metal Insert  
Head Diameter: 20mm  
Stem Length: 13mm  
Fits into 10mm Hole  
Honda Civic 2006 - On

UNIT PACKAGE: 10



**21812**  
(Peugeot & Citroen: 16-092-672-80;  
Renault: 77-03-072-416)  
Black Nylon

Push-Type Retainer  
Rectangular Head Size: 9mm x 20mm  
Head Diameter: 20mm  
Stem Length: 13mm  
Fits into 8mm Hole  
Renault, Dacia, Peugeot and Citroen

UNIT PACKAGE: 25



**19233**  
(91503-SZ3-003)  
Black Nylon

Front Bumper Push-Type Retainer  
Head Diameter: 20mm  
Stem Length: 13mm  
Fits into 10mm Hole  
Acura 3.5RL Sedan & Honda 1996 - On

UNIT PACKAGE: 15

# PUSH-TYPE RETAINERS

## Sec. 19

Refer to Retainer Specification Chart on pages 534-545  
Listed smallest to largest by Head Diameter, Stem Length and then by Hole Diameter.



**21454**  
(91503-SHJ-A01)  
Black Nylon

Front Bumper Push-Type Retainer  
Head Diameter: 20mm  
Stem Length: 13mm  
Fits into 10mm Hole  
Honda Odyssey 2010 - 05

UNIT PACKAGE: 10



**20608**  
(91503-S0K-A01)  
Black Nylon

Grille Mounting Push-Type Retainer  
Head Diameter: 20mm  
Stem Length: 14mm  
Fits into 10mm Hole  
Honda Element 2003 - On

UNIT PACKAGE: 15



**16782**  
(Honda: 91545-SE0-003-W1;  
Nissan: 63848-01G00)  
Black Nylon

Push-Type Retainer  
Head Diameter: 20mm  
Stem Length: 8mm (Excluding the Pin)  
Fits into 8mm Hole

UNIT PACKAGE: 25



**21706**  
(Honda: 91505-TM8-003)  
Black Nylon

Bumper and Wheel Well Liner  
Push-Type Retainer  
Head Diameter: 20mm  
Stem Length: 14mm  
Fits into 10mm Hole  
Acura ILX and Honda Insight 2012 - On

UNIT PACKAGE: 15



**21134**  
(01553-09431)  
Black Nylon

Front Bumper Push-Type Retainer  
Head Diameter: 20mm  
Stem Length: 11mm (Excluding the Pin)  
Fits into 8mm Hole  
Nissan Maxima 2004 - On

UNIT PACKAGE: 15



**20734**  
(51-11-1-944-537)  
Black Nylon

Bumper, Wheel Opening, Scuff Plate &  
Interior Trim Push-Type Retainer  
Head Diameter: 20mm  
Stem Length: 15mm  
Fits into 6.3mm Hole  
BMW Series 3, 5, 7 & X5 1989 - On

UNIT PACKAGE: 50



**21883**  
(Peugeot & Citroen: 6991.X7)  
Black Nylon

Bumper Push-Type Retainer  
Head Diameter: 20mm  
Stem Length: 14mm  
Fits into 8mm Hole  
Peugeot & Citroen

UNIT PACKAGE: 25



**21545**  
(01553-08231)  
Black Nylon

Front & Rear Bumper and  
Grille Push-Type Retainer  
Head Diameter: 20mm  
Stem Length: 15mm  
Fits into 8mm Hole  
Infiniti FX35, FX45 & Q45 and Nissan  
Murano, 240 SX & 350Z 1995 - On

UNIT PACKAGE: 25



**20638**  
(BMW: 51471911992,  
51470146782, 51470390017  
Mercedes-Benz: 201-990-02-92)  
Black Nylon

Push-Type Retainer  
Head Diameter: 20mm  
Stem Length: 14mm  
Fits into 8.5mm Hole  
BMW 1, 2, 3, 4, 5, 6, 7, i3, i8, X &  
Z Series 1988 - On  
Mercedes-Benz

UNIT PACKAGE: 25



**17350**  
(Honda: 91516-SK7-013;  
Nissan: 01553-00-344)  
Black Nylon

Splash Shield Push-Type Retainer  
Phillips Drive  
Head Diameter: 20mm  
Hex: 10mm  
Stem Length: 15mm  
Fits into 8mm Hole  
Honda Civic 1992 - On  
Nissan Xterra, Frontier & Quest 1999 - On

UNIT PACKAGE: 10

**Sec. 19**

**PUSH-TYPE RETAINERS**

Refer to Retainer Specification Chart on pages 534-545

Listed smallest to largest by Head Diameter, Stem Length and then by Hole Diameter.



**17267**

(91503-SP0-003)  
Black Nylon

Front & Rear Bumper  
Push-Type Retainer  
Head Diameter: 20mm  
Stem Length: 15mm  
Fits into 10mm Hole  
Acura Legend 1991 - On

UNIT PACKAGE: 15



**21173**

(91506-S9A-003)  
Black Nylon

Bumper & Splash Shield  
Push-Type Retainer with Metal Insert  
Head Diameter: 20mm  
Stem Length: 16mm  
Fits into 10mm Hole  
Acura MDX, RDX & TSX and Honda  
Accord, Civic CR-V & Fit 2009 - 04

UNIT PACKAGE: 10



**21563**

(909130059)  
Black Nylon

Front Bumper & Fender  
Push-Type Retainer  
Head Diameter: 20mm  
Stem Length: 15mm  
Fits into 10mm Hole  
Subaru Forester, Impreza & Outback 2006 - 02

UNIT PACKAGE: 25



**20766**

(6507669-AA)  
Black Nylon

Radiator Grille Push-Type Retainer  
Head Diameter: 20mm  
Stem Length: 16mm  
Fits into 10mm Hole  
Dodge Durango 2004 - On

UNIT PACKAGE: 25



**21781**

(BMW: 51-71-8-259-788;  
51-71-0-391-077)  
Black Nylon

Rocker Panel, Air Duct Compartment  
& Wheel Housing Push-Type Retainer  
Head Diameter: 20mm  
Stem Length: 16mm  
Fits into 6.3mm Hole  
3, 5, 6, 7 & Z Series 1994 - On

UNIT PACKAGE: 25

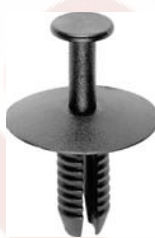

**20248**

(51-11-8-174-185)  
Black Nylon

Bumper Trim Push-Type Retainer  
Head Diameter: 20mm  
Stem Length: 17mm  
Fits into 6.3mm Hole  
BMW Series 3, 5 & 7 1995 - On

UNIT PACKAGE: 25



**20388**

(51218-205-295)  
Black Nylon

Cowl Vent Push-Type Retainer  
Head Diameter: 20mm  
Stem Length: 16mm  
Fits into 7mm Hole  
**Use with Auveco 20254**  
BMW Series 5 1997 - On

UNIT PACKAGE: 50



**22052**

(BMW: 51471919209)  
Black Nylon

Interior Trim & Engine  
Intake Duct Push-Type Retainer  
Head Diameter: 20mm  
Stem Length: 17mm  
Fits into 6.3mm Hole  
BMW 3, 5, 7, 8, X and Z Series 2012 - 1984

UNIT PACKAGE: 25



**21596**

(75867-06030)  
Black Nylon

Rocker Panel Push-Type Retainer  
Head Diameter: 20mm  
Stem Length: 16mm  
Fits into 8mm Hole  
Toyota & Lexus 2007 - On

UNIT PACKAGE: 25



**20458**

(6506132-AA)  
Black Nylon

Side Radiator Shield  
Push-Type Retainer  
Head Diameter: 20mm  
Stem Length: 17mm  
Fits into 7mm Hole  
Chrysler Sebring & Stratus 2001 - On

UNIT PACKAGE: 25



# PUSH-TYPE RETAINERS

## Sec. 19

Refer to Retainer Specification Chart on pages 534-545  
Listed smallest to largest by Head Diameter, Stem Length and then by Hole Diameter.



**16858**  
(Nissan: 63844-01A00;  
Kia: MNA01-56-145;  
Mazda: NA01-56-145;  
Ford: MNA01-56145, NA01-56145)  
Black Nylon  
  
Inner Fender Push-Type Retainer  
Head Diameter: 20mm (25/32")  
Stem Length: 18mm (23/32")  
Fits into 8mm (5/16") Hole  
Nissan 1980 - On  
Mazda, Kia & Ford  
  
UNIT PACKAGE: 25



**20564**  
(91503-SZ5-003)  
Black Nylon  
  
Front & Rear Bumper  
Push-Type Retainer  
Head Diameter: 20mm  
Stem Length: 18mm  
Fits into 10mm Hole  
Acura 3.5RL and Honda Accord & Odyssey 1996 - On  
  
UNIT PACKAGE: 15



**21119**  
(B100-68-675-69)  
Black Nylon  
  
Push-Type Retainer  
Head Diameter: 20mm  
Stem Length: 19mm  
Fits into 6mm Hole  
Ford Probe and Mazda MX6 1988 - On  
  
UNIT PACKAGE: 15



**17472**  
(Mitsubishi: MB547806;  
Nissan: 63854-01A00)  
Black Nylon  
  
Front Bumper Fascia  
Push-Type Retainer  
Head Diameter: 20mm  
Stem Length: 20mm  
Fits into 8mm Hole  
Mitsubishi & Nissan 300ZX 1990 - On  
  
UNIT PACKAGE: 15



**17216**  
(GM: 21030249;  
Ford: N807389S; Chrysler: 6503598)  
Black Nylon  
  
Air Baffle to Under Carriage  
Push-Type Retainer  
Head Diameter: 20mm  
Stem Length: 20mm  
Fits into 8mm Hole  
GM Saturn 2 Door & 4 Door Models 1991 - On  
Ford & Chrysler  
  
UNIT PACKAGE: 25



**20991**  
(11589292)  
Black Nylon  
  
Bumper Fascia, Flares & Air Dam  
Push-Type Retainer  
Head Diameter: 20mm  
Stem Length: 20mm  
Panel Range: 2.0mm - 4.5mm  
Fits into 8.5mm Hole  
Chevrolet and GMC C & K Trucks 2007 - On  
  
UNIT PACKAGE: 25



**16625**  
(10108746)  
Black Nylon  
  
Front Bumper Fascia Retainer  
Head Diameter: 20mm  
Stem Length: 20mm  
Fits into 10mm Square Hole  
GM Station Wagons 1991 - On  
  
UNIT PACKAGE: 25

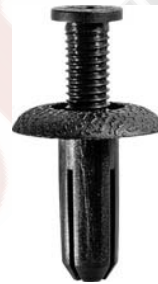

**19140**  
(Acura: 90505-SL0-003;  
GM: 94852368;  
Mitsubishi: MB888869;  
Toyota: 90467-08155)  
Black Nylon  
  
Push-Type Retainer  
Head Diameter: 20mm  
Stem Length: 21mm  
Fits into 8mm Hole  
Acura, Dodge Avenger, Eagle Talon, Geo Prizm,  
Mitsubishi Eclipse & Galant and Toyota 1993 - On  
  
UNIT PACKAGE: 5



**21778**  
(BMW: 51-12-7-004-445)  
Black Nylon  
  
Rear Bumper Support Fixture Trim  
Push-Type Retainer  
Head Diameter: 20mm  
Stem Length: 21mm  
Fits into 8.5mm Hole  
3, 5 & 6 Series 2002 - On  
  
UNIT PACKAGE: 25



**19615**  
(15153415)  
Black Nylon  
  
Rear Bumper Cover  
Push-Type Retainer  
Top Head Diameter: 20mm  
Stem Length: 21mm  
Fits into 9mm Hole  
GM C & K Trucks 1999 - On  
  
UNIT PACKAGE: 25

**Sec. 19**

**PUSH-TYPE RETAINERS**

Refer to Retainer Specification Chart on pages 534-545

Listed smallest to largest by Head Diameter, Stem Length and then by Hole Diameter.



**20348**  
(63878-01E10)  
Black Nylon

Push-Type Retainer  
Head Diameter: 20mm  
Stem Length: 22mm  
Fits into 8mm Hole  
Nissan Maxima 1994 - On

UNIT PACKAGE: 15



**18119**  
(91502-SP0-003)  
Black Nylon

Front & Rear Bumper  
Push-Type Retainer  
Head Diameter: 20mm  
Stem Length: 25mm  
Fits into 10mm Hole  
Honda 1990 - On

UNIT PACKAGE: 10



**20889**  
(GM: 11589293;  
Ford: W712196-S300)  
Black Nylon

Cowl Vent & Fender  
Push-Type Retainer  
Head Diameter: 20mm  
Stem Length: 22mm  
Panel Range: 4.5mm - 7.0mm  
Fits into 8.5mm Hole

Buick Century, LaCrosse & Regal, Cadillac, Chevrolet Equinox, GM Trucks, Hummer H3 and Pontiac Grand Prix & Torrent 1997 - On  
Ford 2006 - On

UNIT PACKAGE: 25



**18951**  
(MR-138807)  
Black Nylon

Front Bumper & Support  
Push-Type Retainer  
Head Diameter: 20mm  
Stem Length: 26mm  
Fits into 8mm Hole  
Mitsubishi Eclipse 1994 - On

UNIT PACKAGE: 5



**20992**  
(11589294)  
Black Nylon

Bumper Fascia, Fender and Toe/Floor  
Panel Push-Type Retainer  
Head Diameter: 20mm  
Stem Length: 24mm  
Panel Range: 7.0mm - 10.0mm  
Fits into 8.5mm Hole

Buick Enclave & LaCrosse, Chevrolet & GMC C & K Trucks, GMC Acadia, Hummer H3 and Saturn Outlook 2005 - On

UNIT PACKAGE: 25



**20632**  
(GM: 11518017;  
Ford: W708530-S300)  
Black Nylon

Bumper Cover & Fender Shield  
Push-Type Retainer  
Head Diameter: 20mm  
Stem Length: 26mm  
Fits into 8mm Hole  
GM & Ford 1997 - On

UNIT PACKAGE: 15



**19739**  
(90467-09127)  
Black Nylon

Bumper Cover Push-Type Retainer  
Head Diameter: 20mm  
Stem Length: 26mm  
Fits into 9mm Hole  
Toyota Avalon, Camry,  
Corolla & Solara 1998 - On

UNIT PACKAGE: 10



**17144**  
(91504-SM4-000)  
Black Nylon

Bumper Fascia Push-Type Retainer  
Head Diameter: 20mm  
Stem Length: 24mm  
Fits into 10mm Hole  
Honda Accord 1990 - On

UNIT PACKAGE: 10



**19408**

Same as 17144 except for unit package quantity

UNIT PACKAGE: 50



**22299**  
(Hyundai: 86590-35000)  
Black Nylon

Bumper Cover  
Push-Type Retainer  
Head Diameter: 20mm  
Stem Length: 26mm  
Fits into 9.5mm Hole  
Hyundai Tucson 2009 - 2005

UNIT PACKAGE: 25

# PUSH-TYPE RETAINERS

## Sec. 19

Refer to Retainer Specification Chart on pages 534-545  
Listed smallest to largest by Head Diameter, Stem Length and then by Hole Diameter.



**17143**  
(Honda: 91502-SM4-000;  
Hyundai 86590-35000)  
Black Nylon

Bumper Fascia Push-Type Retainer  
Head Diameter: 20mm  
Stem Length: 27mm  
Fits into 10mm Hole  
Honda Accord 1990 - On  
Hyundai 2005 - On

UNIT PACKAGE: 10

**19407**

Same as 17143 except unit package quantity

UNIT PACKAGE: 50



**18896**  
(21095797)  
Black Nylon

Bumper Fascia  
Push-Type Retainer  
Head Diameter: 20mm  
Stem Length: 28mm  
Fits into 8mm Hole  
GM Saturn 1996 - On

UNIT PACKAGE: 25



**21420**  
(909140007)  
Black Nylon

Bumper, Engine Cover, Fender & Grille  
Push-Type Retainer  
Head Diameter: 21mm  
Stem Length: 15mm (Excluding the Pin)  
Fits into 10mm Hole  
Subaru Baja, Forester, Impreza, Legacy,  
Outback & Tribeca 2000 - On

UNIT PACKAGE: 15



**20457**  
(4857345-AA)  
Black Nylon

Tail Light Housing  
Push-Type Retainer  
Large Head Diameter: 21mm  
Stem Length: 23mm  
Fits into 9.5mm Hole  
Chrysler Caravan, Town & Country and  
Voyager Mini Vans 2002 - On

UNIT PACKAGE: 25



**16835**  
(GM: 10140480;  
Chrysler: 6502625)  
Black Nylon

Rear Bumper Fascia Retainer  
Head Diameter: 21mm (27/32")  
Shoulder Length: 3mm (1/8")  
Stem Length: 25mm (1")  
Fits into 12mm (1/2") Hole  
GM APV Vans 1990 - On

UNIT PACKAGE: 25



**14998**  
(15672330, 15956470)  
Black Nylon

Push-Type Retainer  
Head Diameter: 27/32" (21.4mm)  
Stem Length: 1" (25.4mm)  
Fits into 13/32" (10.3mm) Hole  
GM 1987 - On

UNIT PACKAGE: 25



**20739**  
(WX68DX9-AA)  
Black Nylon

Door Trim Panel  
Push-Type Retainer  
Head Diameter: 22mm  
Stem Length: 10mm (Excluding the Pin)  
Fits into 9mm Hole  
Chrysler 300 & Dodge Magnum 2005 - On

UNIT PACKAGE: 25



**21021**  
(0WX68BD5-AA)  
Dark Gray Nylon

Door Trim Panel  
Push-Type Retainer  
Head Diameter: 22mm  
Stem Length: 10mm (Excluding the Pin)  
Fits into 9mm Hole  
Chrysler Charger, Magnum & 300M  
2005 - On

UNIT PACKAGE: 25



**21427**  
(0WX68XDB-AA)  
Light Gray Nylon

Door Trim Panel  
Push-Type Retainer  
Head Diameter: 22mm  
Stem Length: 10mm (Excluding the Pin)  
Fits into 9mm Hole  
Chrysler 300M, Charger & Magnum  
2005 - On

UNIT PACKAGE: 25

**Sec. 19**

**PUSH-TYPE RETAINERS**

Refer to Retainer Specification Chart on pages 534-545

Listed smallest to largest by Head Diameter, Stem Length and then by Hole Diameter.



**20948**  
(0WX68BD1-AA)  
Tan Nylon

Door Trim Panel  
Push-Type Retainer  
Head Diameter: 22mm  
Stem Length: 10mm (Excluding the Pin)  
Fits into 9mm Hole  
Chrysler 300M, Charger & Magnum  
2005 - On

UNIT PACKAGE: 25



**22101**  
(Audi: 4D0-807-300)  
Black Nylon

Bumper, Fender & Hood  
Insulation Push-Type Retainer  
Head Diameter: 22mm  
Stem Length: 12mm  
Fits Into 7.5mm Hole  
Audi A4, A5, A8, Q3, Q5 & S8 1997 - On

UNIT PACKAGE: 15



**22095**  
(Audi: N90-229-301)  
Black Nylon

Hood Insulation  
Push-Type Retainer  
Head Diameter: 22mm  
Stem Length: 13mm  
Fits into 8mm Hole  
Audi & Volkswagen 1986 - On

UNIT PACKAGE: 25



**20863**  
(5480772)  
Black Nylon

Lower Rocker Moulding  
Push-Type Retainer  
Head Diameter: 22mm  
Stem Length: 13mm (Excluding the Pin)  
Fits into 15mm Hole  
Chevrolet Equinox 2005 - On

UNIT PACKAGE: 10



**21810**  
(Peugeot & Citroen: 6997.T2)  
Black Nylon

Push-Type Retainer  
Head Diameter: 22mm  
Stem Length: 14mm  
Fits into 6.3mm Hole  
Peugeot & Citroen

UNIT PACKAGE: 25



**17378**  
(01553-0310)  
Black Nylon

Bumper & Fascia  
Push-Type Retainer  
Head Diameter: 22mm  
Stem Length: 14mm (Excluding the Pin)  
Fits into 11mm Hole  
Nissan 1986 - On

UNIT PACKAGE: 15



**21860**  
(Toyota: 51453-48010, 51453-0E010)  
Black Nylon

Front Side Lower Fender Panel  
Bracket Push-Type Retainer  
Head Diameter: 22mm  
Stem Length: 14mm  
Fits into 13mm Hole  
Lexus RX330 2009 - 2004  
Toyota Highlander 2010 - On

UNIT PACKAGE: 15



**21366**  
(90467-09227)  
Black Nylon

Bumper & Engine Under Cover  
Push-Type Retainer  
Head Diameter: 22mm  
Stem Length: 15mm (Excluding the Pin)  
Fits into 9mm Hole  
Toyota 4 Runner, RAV 4 & Scion XB  
2006 - On

UNIT PACKAGE: 10



**20967**  
(Not Available from O.E.M.)  
Black Nylon

Rear Bumper Mounting Bracket  
Push-Type Retainer  
Head Diameter: 22mm  
Stem Length: 16mm  
Fits into 10mm Hole  
Jeep Commander 2006 - On

UNIT PACKAGE: 15



**19847**  
(5973823)  
Blue Nylon

Fascia Retainer  
Head Diameter: 7/8" (22mm)  
Shoulder Length: 5/32" (4mm)  
Stem Length: 25/32" (20mm)  
Fits into 1/2" (12.7mm) Hole  
GM 1979 - On

UNIT PACKAGE: 25

# PUSH-TYPE RETAINERS

## Sec. 19

Refer to Retainer Specification Chart on pages 534-545

Listed smallest to largest by Head Diameter, Stem Length and then by Hole Diameter.



### 20753

(01553-03201)  
Black Nylon

Front & Rear Bumper  
Push-Type Retainer  
Head Diameter: 22mm  
Stem Length: 21mm  
Fits into 8mm Hole  
Nissan 1982 - On

UNIT PACKAGE: 10



### 21251

(6Q0-868-243)  
Black & White Nylon

Trim Panel  
Push-Type Retainer with Sealer  
Head Diameter: 22.5mm  
Stem Length: 8mm (Excluding the Pin)  
Fits into 8mm Hole  
Volkswagen Golf, Jetta, Passat, Phaeton,  
Rabbit & Tiguan 2004 - On

UNIT PACKAGE: 15



### 22282

(Mazda: FD01-68-AC3)  
Gray Nylon

Bumper Filler & Door Panel  
Push-Type Retainer  
Head Diameter: 22mm  
Stem Length: 25mm  
Fits into 8mm Hole  
Mazda 2, 3, 5, 6,  
CX-5, CX-7 & CX-9  
2004 - On

UNIT PACKAGE: 15



### 22256

(Jaguar: XR831159)  
Black Nylon

Radiator Support &  
Air Deflector Shield  
Push-Type Retainer  
Head Diameter: 24mm  
Stem Length: 12mm  
Fits into 12mm Hole  
Jaguar X, XF, XJ-L & XK 2012 - On

UNIT PACKAGE: 10



### 18269

(6503106)  
Black Nylon

Lower Sill Moulding  
Push-Type Retainer  
Large Head Diameter: 7/8" (22mm)  
Stem Length: 1" (25.4mm)  
Fits into 1/4" (6.4mm) Hole  
Jeep Grand Cherokee Laredo 1994 - On

UNIT PACKAGE: 15



### 21482

(1H0-867-199-A)  
Black Nylon

Push-Type Retainer  
Head Diameter: 24mm  
Stem Length: 13mm  
Fits into 9mm Square Hole  
VW Passat 1999 - 90

UNIT PACKAGE: 25



### 15043

(14103461)  
Black Nylon

Bumper Fascia Retainer  
Head Diameter: 7/8" (22mm)  
Shoulder Length: 5/32" (4mm)  
Stem Length: 1-3/64" (26.5mm)  
Fits into 1/2" (12.7mm) Hole  
GM 1987 - On

UNIT PACKAGE: 25



### 21452

(1H0-819-055-C01C)  
Black Nylon

Push-Type Retainer  
Top Head Diameter: 23mm  
Bottom Head Diameter: 16mm  
Stem Length: 15mm  
Fits into 8mm x 8mm Square Hole  
VW 2002 - 1993

UNIT PACKAGE: 25



### 21578

(57750AA090)  
Black Nylon

Front & Rear Bumper  
Push-Type Retainer  
Head Diameter: 22mm  
Stem Length: 28mm  
Fits into 10mm Hole  
Subaru Impreza & Legacy 2001 - 1993

UNIT PACKAGE: 25



### 20767

(4806110-AA)  
Black & White Nylon

Front Bumper Push-Type Retainer  
Head Diameter: 24mm  
Shoulder Length: 3mm  
Stem Length: 20mm  
Fits into 11mm Hole  
Chrysler 300 & Dodge Magnum 2005 - On

UNIT PACKAGE: 15

**Sec. 19**

**PUSH-TYPE RETAINERS**

Refer to Retainer Specification Chart on pages 534-545

Listed smallest to largest by Head Diameter, Stem Length and then by Hole Diameter.



**21376**

(4389947-AA)  
Black and White Nylon

Bumper Cover  
Push-Type Retainer with Sealer  
Head Diameter: 24mm  
Shoulder Length: 3mm  
Stem Length: 20mm  
Fits into 11mm Hole  
Chrysler Avenger, Journey & Sebring  
2008 - On

UNIT PACKAGE: 10



**20233**

(W705956-S300)  
Black Nylon

Cowl Push-Type Retainer  
Head Diameter: 25mm  
Shoulder Diameter: 10mm  
Shoulder Length: 3mm  
Stem Length: 12mm (Excluding the Pin)  
Fits into 9mm Hole  
Lincoln LS 1999 - On

UNIT PACKAGE: 15



**21176**

(10382313)  
Black Nylon

Sight Shield & Trim  
Push-Type Retainer  
Head Diameter: 24.5mm  
Stem Length: 13mm (Excluding the Pin)  
Fits into 9mm Hole  
Cadillac STS, Pontiac Solstice and  
Saturn Sky 2005 - On

UNIT PACKAGE: 10



**22047**

(Subaru: 94415FA000NE)  
Gray & Black Nylon

Rear Roof Spoiler Trim  
Push-Type Retainer  
Top Head Diameter: 25mm  
Bottom Head Diameter: 21mm  
Stem Length: 9mm (Not including the Pin)  
Fits into 8mm Hole  
Impreza 2007 - 1998

UNIT PACKAGE: 15



**20518**

(W705957-S300, W706519-S300)  
Black Nylon

Radiator Sight Shield  
Push-Type Retainer  
Head Diameter: 24.5mm  
Stem Length: 14mm  
Fits into 9mm Hole  
Lincoln LS 2000 - On

UNIT PACKAGE: 10



**21501**

(909140055)  
Black Nylon

Push-Type Retainer with Sealer  
Head Diameter: 25mm  
Shoulder Length: 3mm  
Shoulder Diameter: 16.5mm  
Stem Length: 16mm (Excluding the Pin)  
Fits into 11mm Hole  
Subaru 2006 - On

UNIT PACKAGE: 5



**21400**

(10426555)  
Natural Nylon

Front Bumper  
Push-Type Retainer  
Top Head Diameter: 24.5mm  
Bottom Head Diameter: 23.5mm  
Stem Length: 36mm  
Fits into 10mm Hole  
Buick Allure & LaCrosse  
Chevrolet Impala &  
Monte Carlo and  
Pontiac Grand Prix 2000 - On

UNIT PACKAGE: 15



**21576**

(909140002)  
Black Nylon

Rocker, Pillar, Floor & Exterior Trim  
Push-Type Retainer with Sealer  
Head Diameter: 25mm  
Shoulder Diameter: 17mm  
Shoulder Length: 3mm  
Stem Length: 16mm (Excluding the Pin)  
Fits into 11mm Hole  
Subaru B9 Tribeca, Baja, Legacy &  
Outback 2000 - On

UNIT PACKAGE: 25

# PUSH-TYPE RETAINERS

Refer to Retainer Specification Chart on pages 534-545  
Listed smallest to largest by Head Diameter, Stem Length and then by Hole Diameter.



## 20993

(GM: 11589295; Ford: W712665-S300)  
Black Nylon

Fender, Flare, Gas Tank & Panel Attachment Push-Type Retainer  
Head Diameter: 25mm  
Stem Length: 20mm  
Panel Range: 3.0mm - 6.0mm  
Fits into 10.5mm Hole  
Chevrolet Cobalt & HHR,  
GM C & K Trucks and  
Pontiac G5 2005 - On

UNIT PACKAGE: 25



## 21361

(GM: 11561874;  
Nissan: 622A2-9E000A)  
Black Nylon

Bumper Cover Push-Type Retainer  
Head Diameter: 25mm  
Stem Length: 29mm  
Fits into 7mm Hole  
Chevrolet Malibu 2008 - On  
Saturn Aura 2007 - On  
Pontiac G6 2010 - On  
Nissan Altima 1997 - On

UNIT PACKAGE: 15



## 20994

(11589296)  
Black Nylon

Panel Attachment & General Purpose Push-Type Retainer  
Head Diameter: 25mm  
Stem Length: 23mm  
Panel Range: 6.0mm - 9.00mm  
Fits into 10.5mm Hole  
Buick Enclave and GMC Acadia 2007 - On

UNIT PACKAGE: 25



## 19244

(N808847-S)  
Black Nylon

Trunk Trim Panel Push-Type Retainer  
Head Diameter: 1" (25.4mm)  
Stem Length: 11/16" (17.5mm)  
Fits into 1/4" (6.4mm) Square Hole  
Ford Taurus & Sable 1996 - On

UNIT PACKAGE: 25



## 22284

(Ford: W718365-S300)  
Black Nylon

Front Fender, Cowl Grille, Rocker & Mudguard Push-Type Retainer  
Head Diameter: 25mm  
Stem Length: 24mm  
Fits into 8.5mm Hole  
Ford Mustang & Transit Connect and Lincoln MKC 2014 - On

UNIT PACKAGE: 10



## 14010

(14045480)  
Black Nylon

Fascia Retainer  
Head Diameter: 1" (25.4mm)  
Stem Length: 23/32" (18.3mm)  
Fits into 3/8" (9.5mm) Hole  
GM 1982 - On

UNIT PACKAGE: 25



## 15701

(N804674-S)  
Black Nylon

Push-Type Retainer  
Head Diameter: 25mm  
Stem Length: 27mm  
Fits into 7mm Hole  
Ford Mustang & Capri

UNIT PACKAGE: 50



## 12757

(5973400)  
Black Nylon

Fascia Retainer  
Head Diameter: 1" (25.4mm)  
Shoulder Length: 1/8" (3.2mm)  
Stem Length: 3/4" (19mm)  
Fits into 1/2" (12.7mm) Hole  
GM 1979 - On

UNIT PACKAGE: 15

## 16265

Same as 12757 except unit package quantity

UNIT PACKAGE: 50

**Sec. 19**

**PUSH-TYPE RETAINERS**

Refer to Retainer Specification Chart on pages 534-545

Listed smallest to largest by Head Diameter, Stem Length and then by Hole Diameter.



**14147**

(20547865)  
Black Nylon

Body Retainer  
Head Diameter: 1" (25.4mm)  
Stem Length: 7/8" (22mm)  
Fits into 1/4" (6.4mm) Hole  
GM 1984 - On

UNIT PACKAGE: 25



**14994**

(N804837S)  
Black Nylon

Push-Type Retainer  
Head Diameter: 1" (25.4mm)  
Stem Length: 29/32" (23mm)  
Fits into 1/4" (6.4mm) Hole  
Ford 1987 - On

UNIT PACKAGE: 50



**14020**

(Ford: N802781-S; GM: 14093088)  
Black Nylon

Splash Shield & Fascia Retainer  
Head Diameter: 1" (25.4mm)  
Stem Length: 7/8" (22mm)  
Fits into 1/4" (6.4mm) Hole  
GM & Ford

UNIT PACKAGE: 25



**18310**

(22587036)  
Black Nylon

Rear Bumper Fascia  
Push-Type Retainer  
Head Diameter: 1" (25.4mm)  
Stem Length: 15/16" (24mm)  
Fits into 3/8" (9.5mm) Hole  
Chevrolet Cavalier & Pontiac Sunfire  
1995 - On

UNIT PACKAGE: 25



**14019**

(Ford: N803421-S, Chrysler: 6501590)  
Black Nylon

Splash Shield & Fascia Retainer  
Head Diameter: 1" (25.4mm)  
Shoulder Length: 1/8" (3.2mm)  
Stem Length: 7/8" (22mm)  
Fits into 5/16" (8mm) Hole  
Ford & Chrysler

UNIT PACKAGE: 25



**15702**

(14101262)  
Black Nylon

Plastic Cover on Engine  
Compartment Retainer  
Head Diameter: 1" (25.4mm)  
Shoulder Length: 1/8" (3.2mm)  
Stem Length: 15/16" (24mm)  
Fits into 1/2" (12.7mm) Hole  
Buick, Oldsmobile & Pontiac 1988 - On

UNIT PACKAGE: 25



**13994**

(GM: 20570245, 20635065;  
Ford: N804614S)  
Black Nylon

Splash Shield, Seat Cushion &  
Spare Tire Retainer  
Head Diameter: 1" (25.4mm)  
Stem Length: 7/8" (22mm)  
Fits into 5/16" (8mm) Hole  
GM 1984 - On  
Ford

UNIT PACKAGE: 25



**20265**

(25663903)  
Black Nylon

Radiator Support Sight Shield  
Push-Type Retainer  
Head Diameter: 1" (25.4mm)  
Stem Length: 1" (25.4mm)  
Fits into 1/4" (6.4mm) Hole  
Cadillac DeVille & Seville 1998 - On

UNIT PACKAGE: 10



**12756**

(5973996)  
Brown Nylon

Fascia Retainer  
Head Diameter: 1" (25.4mm)  
Shoulder Length: 1/4" (6.4mm)  
Stem Length: 7/8" (22mm)  
Fits into 1/2" (12.7mm) Hole  
GM 1982 - On

UNIT PACKAGE: 15



**18503**

(W701054-S300)  
Black Nylon

Front Bumper Push-Type Retainer  
Head Diameter: 1" (25.4mm)  
Stem Length: 1" (25.4mm)  
Fits into 5/16" (8mm) Hole  
Ford Contour & Mystique 1995 - On

UNIT PACKAGE: 25



# PUSH-TYPE RETAINERS

## Sec. 19

Refer to Retainer Specification Chart on pages 534-545  
Listed smallest to largest by Head Diameter, Stem Length and then by Hole Diameter.



### 15044

(22535007)  
Black Nylon

Bumper Fascia Retainer  
Head Diameter: 1" (25.4mm)  
Shoulder Length: 1/8" (3.2mm)  
Stem Length: 1" (25.4mm)  
Fits into 1/2" (12.7mm) Hole  
GM 1987 - On

UNIT PACKAGE: 25



### 18268

(15959832)  
Black Nylon

Front License Plate Bracket  
Push-Type Retainer  
Head Diameter: 1" (25.4mm)  
Shoulder Length: 9/64" (3.6mm)  
Stem Length: 1-5/8" (41.3mm)  
Fits into 1/2" (12.7mm) Hole  
GM Truck 1994 - On

UNIT PACKAGE: 5



### 15045

(10053388, 22542705)  
Black Nylon

Bumper Fascia Retainer  
Head Diameter: 1" (25.4mm)  
Shoulder Length: 1/8" (3.2mm)  
Stem Length: 1-7/64" (28.2mm)  
Fits into 1/2" (12.7mm) Hole  
GM 1987 - On

UNIT PACKAGE: 25



### 18334

(15959833)  
Gray Nylon

Front License  
Plate Bracket  
Push-Type Retainer  
Head Diameter: 1" (25.4mm)  
Stem Length: 1-3/4" (44.5mm)  
Fits into 1/2" (12.7mm) Hole  
GM S-10 Truck with  
Decor Package  
1994 - On

UNIT PACKAGE: 5



### 18394

(6503453)  
Black Nylon

Bumper Fascia Retainer  
Head Diameter: 1" (25.4mm)  
Stem Length: 1-1/8" (28.5mm)  
Fits into 1/4" (6.4mm) Hole  
Jeep Grand Cherokee 1994 - On

UNIT PACKAGE: 25



### 21238

(22718369)  
Black Nylon

Fuel Tank Shield &  
Miscellaneous Push-Type Retainer  
Head Diameter: 26mm  
Stem Length: 12mm  
Fits into 10mm Hole  
Chevrolet Malibu & Trail Blazer 2004 - On

UNIT PACKAGE: 25



### 15042

(10077283)  
Black Nylon

Bumper Fascia Retainer  
Head Diameter: 1" (25.4mm)  
Shoulder Length: 1/4" (6.4mm)  
Stem Length: 1-1/8" (28.5mm)  
Fits into 1/2" (12.7mm) Hole  
GM 1982 - On

UNIT PACKAGE: 25



### 19892

(25695687)  
Black Nylon

Radiator Support Sight Shield  
Push-Type Retainer  
Head Diameter: 27mm  
Shoulder Length: 7mm  
Stem Length: 18mm  
(Excluding the Pin)  
Fits into 10mm Hole  
Cadillac DeVille & Seville 2000 - On

UNIT PACKAGE: 15

**Sec. 19**

**PUSH-TYPE RETAINERS**

Refer to Retainer Specification Chart on pages 534-545

Listed smallest to largest by Head Diameter, Stem Length and then by Hole Diameter.



**17616**

(21077131)  
Black Nylon

Bumper Fascia  
Push-Type Retainer  
Head Diameter: 1-3/16" (30mm)  
Stem Length: 2" (51mm)  
Fits into 7/16" (11mm) Hole  
GM Saturn 1991 - On

UNIT PACKAGE: 10



**17080**

(OH452KD5)  
Nylon Quartz Matte Finish

Headliner Retainer  
Head Diameter: 1-1/4" (32mm)  
Stem Length: 7/16" (11mm)  
Fits into 1/4" (6.4mm) Hole  
Dodge Caravan & Plymouth Voyager  
1984 - On

UNIT PACKAGE: 15



**20963**

(4806334-AA)  
Black & White Nylon

Rear Bumper Push-Type  
Retainer with Sealer  
Head Diameter: 34mm  
Shoulder Length: 3.5mm  
Stem Length: 17mm  
Fits into 8.5mm Hole  
Dodge Caliber and  
Jeep Compass & Patriot  
2007 - On

UNIT PACKAGE: 10



**22339**

(Mercedes: 001-990-01-92)  
Black Nylon

Rocker Panel Moulding  
Push-Type Retainer  
Head Diameter: 30.5mm  
T25 Drive  
Stem Length: 17mm  
Fits into 8.5mm Hole  
Mercedes-Benz CLS550,  
CLS63 AMG, SL550, SL600,  
SL63 AMG, SLK300, SLK350  
and SLK55 AMG 2011 - 2008

UNIT PACKAGE: 25



**19638**

(Chrysler: 4805405AA;  
Ford: 1L5Z-17K826AA)  
Black & White Nylon

Front Bumper Fascia  
Push-Type Retainer  
Head Diameter: 34mm  
Shoulder Length: 3mm  
Stem Length: 20mm  
Fits into 8mm Hole  
Chrysler Concorde, Intrepid, Eagle,  
Pacifica & PT Cruiser 1998 - On  
Ford Trucks 2005 - On

UNIT PACKAGE: 15



**21348**

(6508643-AA)  
Black Nylon

Tail Light Push-Type Retainer  
Top Head Diameter: 31.5mm  
Bottom Head Diameter: 20mm  
Stem Length: 23mm  
Fits into 10mm Hole  
Dodge Nitro and Jeep 2008 - On

UNIT PACKAGE: 15



**22072**

(Toyota: 76923-47010)  
Black Nylon

Rocker Moulding  
Push-Type Retainer  
Head Diameter: 38mm  
Stem Length: 32mm  
Fits into 22mm Hole  
Lexus HS 250h & CT 200h  
and Toyota Prius 2010 - On

UNIT PACKAGE: 5

# PUSH-TYPE RETAINERS

## Sec. 19

Refer to Retainer Specification Chart on pages 534-545  
Listed smallest to largest by Head Diameter, Stem Length and then by Hole Diameter.



### 16115

(5113-885-399)  
Black Nylon

Push-Type Retainer  
Head Size: 7mm x 15mm  
Stem Length: 17mm  
Fits into 6mm x 6mm Hole  
BMW

UNIT PACKAGE: 25



### 16725

(66814-01G00)  
Black Nylon

Cowl Grille Retainer  
Head Size: 8mm x 12mm  
Stem Length: 8mm  
Fits into 6mm Square Hole  
Nissan Pick-Up 1986 - On

UNIT PACKAGE: 25



### 20923

(Ford: 3M8Z-1502316-A;  
Mazda: GJ6E-50-715A)  
Black Nylon

Cowl Vent Push-Type Retainer  
Head Size: 8.5mm x 12mm  
Stem Length: 9mm  
Fits into 5mm Hole  
Ford Fusion, Milan & Zephyr 2006 - On  
Mazda 5 & 6 2003 - On

UNIT PACKAGE: 15



### 20407

(9133073-8)  
Black Nylon

Hood Insulation & Radiator Seal  
Push-Type Retainer  
Head Size: 8mm x 25mm  
Stem Length: 10mm  
Fits into 5mm Hole  
Volvo 850, 940, 960, S80, S90 & V90 1991 - On

UNIT PACKAGE: 25



### 20203

(124-990-07-92)  
Black Nylon

Push-Type Retainer  
Head Size: 11mm x 14mm  
Stem Length: 8mm  
Fits into 7mm x 8mm Hole  
Mercedes-Benz 124, 129, 140, 170, 202,  
203, 208, 210, 215 & 220 1986 - On

UNIT PACKAGE: 25



### 14953

(Ford: N803494S; GM: 15679091)  
Black Nylon

Fascia, Trim & Grille Retainer  
Head Size: " 15/32" x 15/32"  
(12mm x 12mm)  
Stem Length: 21/32" (16.7mm)  
Fits into 1/4" (6.4mm) Square Hole or Slot  
Ford Aerostar, Escort & Lynx 1985 - On  
GM 1994 - On

UNIT PACKAGE: 25



### 14725

(66824-W1000)  
Black Nylon

Push-Type Retainer  
Head Size: 12mm x 18mm  
Stem Length: 10mm  
Fits into 6mm Hole  
Nissan

UNIT PACKAGE: 15



### 22041

(GM: 92139147)  
Black Nylon

Front & Rear Bumper Fascia  
Push-Type Retainer  
Head Size: 14mm x 21mm  
Stem Length: 16mm  
Fits into 8mm Hole  
Chevrolet Caprice and  
Pontiac G8 & GTO 2011 - 04

UNIT PACKAGE: 25



### 14727

(Nissan: 63844-D0100;  
Isuzu: 8942211500)  
Black Nylon

Push-Type Retainer  
Head Size: 14mm x 22mm  
Stem Length: 9mm  
Fits into 7mm Hole  
Isuzu & Nissan

UNIT PACKAGE: 25

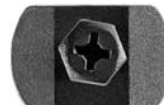

### 20892

(12337831)  
Black Nylon

Front Bumper Push-Type Retainer  
Head Size: 14mm x 26mm  
Stem Length: 14mm  
Fits into 8mm Hole  
Pontiac G6 2005 - On

UNIT PACKAGE: 50

## Sec. 19

# PUSH-TYPE RETAINERS

Refer to Retainer Specification Chart on pages 534-545

Listed smallest to largest by Head Diameter, Stem Length and then by Hole Diameter.



### 14008

(14032200)  
Black Nylon

Grille Attachment Retainer  
Head Size: 19/32" x 3/4"  
(15mm x 19mm)  
Stem Length: 19/32" (15mm)  
Fits into 5/16" (8mm) Hole  
GM 1981 - On

UNIT PACKAGE: 25

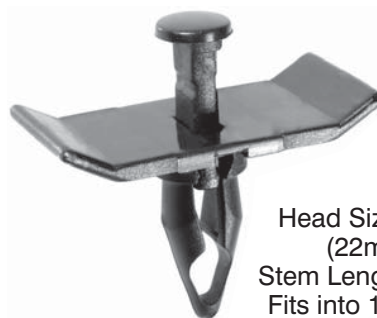

### 18029

(4630253)  
Black Nylon

Rear Fascia  
Push-Type Retainer  
Head Size: 7/8" x 1-25/32"  
(22mm x 45.5mm)  
Stem Length: 1-1/16" (27mm)  
Fits into 1/2" (12.7mm) Hole  
Chrysler Concorde & LHS  
Dodge Intrepid & Eagle Vision  
1993 - On

UNIT PACKAGE: 15



### 17104

(6501630, 6501772, 6501878)  
Black Nylon

Headlight & Tail Light  
Panel Attachment  
Push-Type Retainer  
Head Size: 15mm x 31mm  
Stem Length: 17mm  
Fits into 5mm x 6.5mm Hole  
Dodge Daytona 1987 - On

UNIT PACKAGE: 10



### 20890

(55157112-AA, 55157112-AB)  
Black & Natural Nylon

Bumper Cover  
Push-Type Retainer  
Head Size: 25mm x 45mm  
Shoulder Length: 3mm  
Stem Length: 20mm  
Fits into 9.5mm Hole  
Jeep Liberty 2005 - On

UNIT PACKAGE: 15



### 16843

(Mazda: BF82-50-233;  
Nissan: 01553-01393)  
Black Nylon

Bumper Cover  
Push-Type Retainer  
Head Size: 20mm x 30mm  
Stem Length: 18mm  
Fits into 10mm Hole  
Mazda & Nissan

UNIT PACKAGE: 10

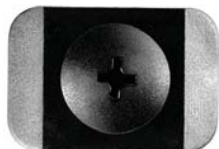

## BODY HARDWARE MASTER PROGRAM

The Body Hardware Master Program, 6600BHM is based on Auveco's Display Boards, DB-428.

We have developed 20 large metal drawer assortments, which come in heavy gauge steel, pre-labeled and pre-loaded large drawers and cabinets.

Learn more about the Body Hardware Master Program in the green section of the catalog, online at [www.auveco.com](http://www.auveco.com) or contact customer service at 1-800-354-9816 or [mail@auveco.com](mailto:mail@auveco.com).

## "428" DISPLAY BOARDS

428 of the most popular body hardware and fastener items are shrink-wrapped onto seven different boards. Each board contains product groups, body shops are familiar with and use often.

The back of each board contains each part number, unit package quantity, OEM number and size specification. The backs are protected by a clear plastic liner.

Learn more about the display boards at the front of the catalog, online at [www.auveco.com](http://www.auveco.com) or contact customer service at 1-800-354-9816 or [mail@auveco.com](mailto:mail@auveco.com)

# PUSH-TYPE RETAINER SPECIFICATION CHART

## Sec. 19



Auveco Part No.	Type	Head Diameter	Stem Length	Fits in Hole Size	Shoulder Length	Color	Page No.
11699	7	11/16" (17.5mm)	5/8" (16mm)	1/4" (6.4mm)		Black	506
11702	7	25/64" (10mm)	19/32" (15mm)	9/32" (7.1mm)		Natural	491
11704	7	11/16" (17.5mm)	7/16" (11mm)	9/32" (7.1mm)		Black	505
11705	7	19/32" (15mm)	5/8" (16mm)	1/4" (6.4mm)		Black	500
11706	7	3/4" (19mm)	11/16" (17.5mm)	1/4" x 1/4" (6.4mm x 6.4mm)	1/4" (6.4mm)	Black	514
11854	7	7/16" (11mm)	9/32" (7.1mm)	3/16" (4.8mm)		Natural	492
12567	5	11/16" (17.5mm)	9/16" (14.3mm)	1/4" (6.4mm)		Black	505
12756	5	1" (25.4mm)	7/8" (22mm)	1/2" (12.7mm)	1/4" (6.4mm)	Brown	529
12757	5	1" (25.4mm)	3/4" (19mm)	1/2" (12.7mm)	3/4" (19mm)	Black	528
13230	7	10mm	7mm	5mm		Black	490
13457	1 (Phillips Hex Drive)	43/64" (17mm)	23/64" (18.3mm)	5/16" (8mm)		Black	505
13469	1 (Phillips Hex Drive)	3/4" (19mm)	1/2" (12.7mm)	1/4" (6.4mm)		Black	513
13993	6	11/16" (17.5mm)	7/8" (22mm)	1/4" (6.4mm)		Black	506
13994	6	1" (25.4mm)	7/8" (22mm)	5/16" (8mm)		Black	529
13996	6	11/16" (17.5mm)	7/8" (22mm)	9/32" (7.1mm)		Black	506
13999	3	3/8" (9.5mm)	1/2" (12.7mm)	7/32" (5.6mm)		Black	490
14001	5	21/32" (16.7mm)	19/32" (15mm)	5/16" (8mm)		Black	504
14007	5	11/16" (17.5mm)	9/16" (14.3mm)	1/4" (6.4mm)		Black	505
14008	11	19/32" x 3/4" (15mm x 19mm)	19/32" (15mm)	5/16" (8mm)		Black	533
14010	5	1" (25.4mm)	23/32" (18.3mm)	3/8" (9.5mm)		Black	528
14011	5	21/32" (16.7mm)	9/16" (14.3mm)	5/16" (8mm)		Black	504
14016	3	3/8" (9.5mm)	7/16" (11mm)	3/16" (4.8mm)		Black	490
14018	3	18mm	23mm	7mm		Black	512

**Sec. 19**

**PUSH-TYPE RETAINER SPECIFICATION CHART**



Auveco Part No.	Type	Head Diameter	Stem Length	Fits in Hole Size	Shoulder Length	Color	Page No.
14019	6	1" (25.4mm)	7/8" (22mm)	5/16" (8mm)	1/8" (3.2mm)	Black	529
14020	6	1" (25.4mm)	7/8" (22mm)	1/4" (6.4mm)		Black	529
14147	6	1" (25.4mm)	7/8" (22mm)	1/4" (6.4mm)		Black	529
14260	1	15mm	12mm	7mm		Black	498
14369	1	20mm	9mm	6mm		Black	515
14696	1	15mm	11mm	6mm		Black	498
14697	1	14mm	11mm	7mm		Black	496
14698	1	18mm	11mm	6mm		Black	508
14725	10	12mm x 18mm	10mm	6mm		Black	532
14726	1	17mm	18mm	8mm		Black	505
	(Phillips Hex Drive)						
14727	10	14mm x 22mm	9mm	7mm		Black	532
14753	2	11/16" (17.5mm)	7/8" (22mm)	1/4" (6.4mm)		Black	506
14953	10	15/32" x 15/32" (12mm x 12mm)	21/32" (16.7mm)	1/4" x 1/4" (6.4mm x 6.4mm)		Black	532
14987	2	11mm (7/16")	18mm (11/16")	6mm (15/64")		Black	493
14988	2	7/16" (11mm)	11/16" (17.5mm)	15/64" (6mm)		Black	493
14990	2	7/16" (11mm)	15/32" (11.9mm)	15/64" (6mm)		Black	492
	(Torx Drive)						
14991	2	11/16" (17.5mm)	11/16" (17.5mm)	1/4" (6.4mm)		Black	506
14992	2	19/32" (15mm)	29/32" (23mm)	1/4" (6.4mm)		Black	500
14993	2	11/16" (17.5mm)	7/8" (22mm)	1/4" (6.4mm)		Black	506
14994	2	1" (25.4mm)	29/32" (23mm)	1/4" (6.4mm)		Black	529
14995	2	1/2" (12.7mm)	1-13/64" (30.5mm)	9/32" (7mm)		Black	495
14997	2	19/32" (15mm)	13/16" (20.6mm)	5/16" (8mm)		Black	500
14998	2	27/32" (21.4mm)	1" (25.4mm)	13/32" (10.3mm)		Black	524
15042	6	1" (25.4mm)	1-1/8" (28.5mm)	1/2" (12.7mm)	1/4" (6.4mm)	Black	530
15043	6	7/8" (22mm)	1-3/64" (26.5mm)	1/2" (12.7mm)	5/32" (4mm)	Black	526

\*Not including the pin

# PUSH-TYPE RETAINER SPECIFICATION CHART

## Sec. 19

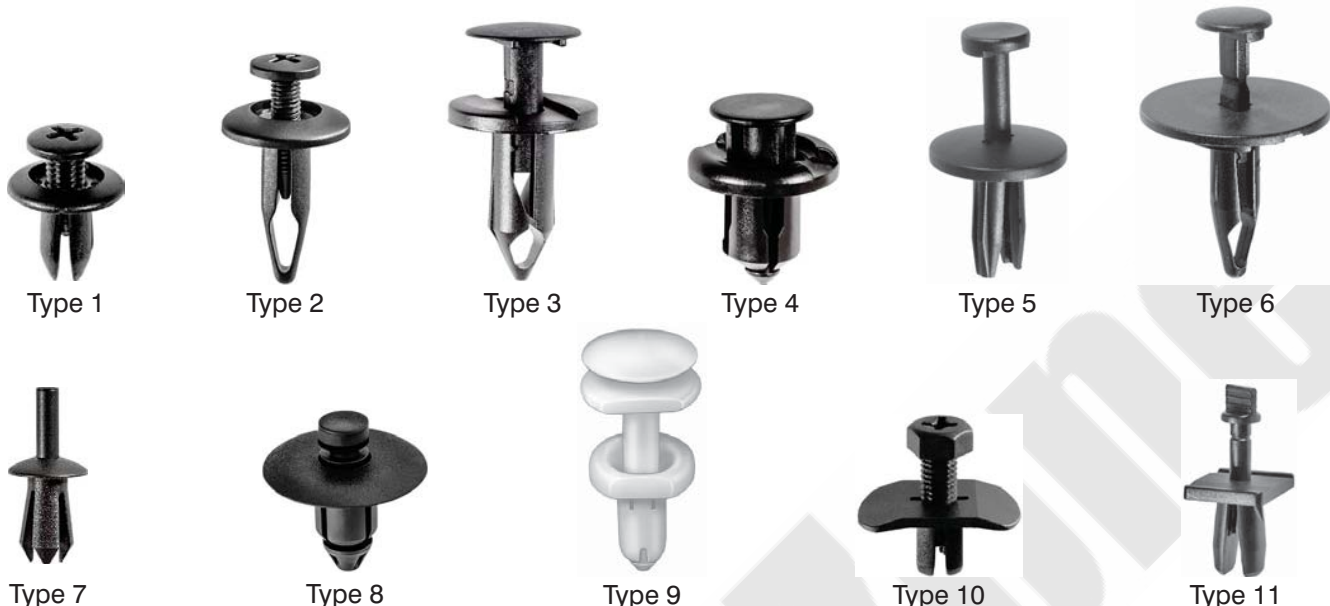

Auveco Part No.	Type	Head Diameter	Stem Length	Fits in Hole Size	Shoulder Length	Color	Page No.
15044	6	1" (25.4mm)	1" (25.4mm)	1/2" (12.7mm)	1/8" (3.2mm)	Black	530
15045	6	1" (25.4mm)	1-7/64" (28.2mm)	1/2" (12.7mm)	1/8" (3.2mm)	Black	530
15522	5 (16mm)	5/8" (13.5mm)	17/32" (6.4mm)	1/4"		Black	503
15672	1 (Phillips Hex Drive)	17mm	14mm	8mm (5/16")		Black	505
15701	6	25mm	27mm	7mm		Black	528
15702	6	1" (25.4mm)	15/16" (24mm)	1/2" (12.7mm)	1/8" (3.2mm)	Black	529
16000	1	20mm	9mm	8mm		Black	516
16115	10	7mm x 15mm	17mm	6mm x 6mm		Black	532
16265	5	1" (25.4mm)	3/4" (19mm)	1/2" (12.7mm)	3/4" (19mm)	Black	528
16622	6	18mm	23mm	9.5mm (3/8")		Black	512
16624	3	17mm	18mm	9.5mm (3/8")	2mm	Black	505
16625	6	20mm	20mm	10mm x 10mm		Black	522
16725	11	8mm x 12mm	8mm	6mm x 6mm		Black	532
16726	3	18mm	18mm	6.3mm x 6.3mm		Black	510
16782	8	20mm	8mm*	8mm		Black	520
16783	8	12mm	8mm*	6mm		Black	493
16784	8	18mm	11mm*	7mm		Black	508
16816	3	14mm	14mm	6mm		Black	497
16835	2	27/32" (21mm)	1" (25mm)	1/2" (12mm)	1/8" (3mm)	Black	524
16843	10	20mm x 30mm	18mm	10mm		Black	533
16858	2	25/32" (20mm)	23/32" (18mm)	5/16" (8mm)		Black	522
16859	2	9/16" (14mm)	5/8" (16mm)	1/4" (6mm)		Black	497
17057	2	18mm	21mm	8mm		Black	512
17080	7	1-1/4" (32mm)	7/16" (11mm)	1/4" (6.4mm)		Quartz Matte Finish	531
17081	1	18mm	12mm	6mm		Black	508
17103	3	15mm	23mm	6mm		Black	500
17104	10	15mm x 31mm	17mm	5mm x 6.5mm		Black	533
17106	3	1/2" (12.7mm)	7/16" (11mm)	3/16" (4.8mm)		Black	495
17143	2	20mm	27mm	10mm		Black	524
17144	2	20mm	24mm	10mm		Black	523
17162	8	15mm	8mm*	6.3mm		Black	499

\*Not including the pin

**Sec. 19**

**PUSH-TYPE RETAINER SPECIFICATION CHART**



Auveco Part No.	Type	Head Diameter	Stem Length	Fits in Hole Size	Shoulder Length	Color	Page No.
17192	4	18mm	14mm	8mm		Black	509
17206	1	15mm	12mm	9mm		Black	499
17214	2 (Torx Drive)	7/16" (11mm)	11/16" (18mm)	15/64" (6mm)		Black	493
17216	3	20mm	20mm	8mm		Black	522
17222	3	15mm	20mm	8mm		Black	500
17226	3	15mm	29mm	8mm		Black	501
17227	7	7mm	10mm	5mm		Black	490
17267	1	20mm	15mm	10mm		Black	521
17287	1	13mm	11mm	6mm		Black	495
17347	8	20mm	11mm*	8mm		Black	518
17350	1 (Phillips Hex Drive)	20mm	15mm	8mm		Black	520
17351	1	17mm	10mm	7mm		Black	504
17378	1	22mm	14mm*	11mm		Black	525
17379	1	20mm	9mm	8mm		Black	516
17383	8	11mm	14mm*	7mm		Black	492
17439	2	15mm	27mm	9mm		Black	501
17472	2	20mm	20mm	8mm		Black	522
17478	3	14mm	16mm	6mm		Black	497
17616	6	1-3/16" (30mm)	2" (51mm)	7/16" (11mm)		Black	531
17632	1	18mm	12mm	8mm		Black	508
17988	2	19mm	26mm	9mm		Black	514
17992	1	20mm	12mm	7mm		Black	518
18029	Misc.	7/8" x 1-25/32" (22mm x 45.5mm)	1-1/16" (27mm)	1/2" (12.7mm)		Black	533
18030	6	11/16" (17.5mm)	13/16" (20.6mm)	1/4" (6.4mm)		Black	506
18032	2	15/32" (11.9mm)	9/16" (14.3mm)	1/4" (6.4mm)		Black	493
18119	1	20mm	25mm	10mm		Black	523
18165	4	17mm	9mm	8mm		Black	504
18206	4	18mm	12mm	6mm		Gray	508
18265	6	16mm	20mm	8mm		Black	503
18268	6	1" (25.4mm)	1-5/8" (41.3mm)	1/2" (12.7mm)	9/64" (3.6mm)	Black	530
18269	5	7/8" (22mm)	1" (25.4mm)	1/4" (6.4mm)		Black	526
18270	8	17mm	9mm	7mm		Black	504
18308	3	3/4" (19mm)	1-1/8" (28.5mm)	1/4" (6.4mm)		Black	514

\*Not including the pin



# PUSH-TYPE RETAINER SPECIFICATION CHART

## Sec. 19



Auveco Part No.	Type	Head Diameter	Stem Length	Fits in Hole Size	Shoulder Length	Color	Page No.
18310	6	1" (25.4mm)	15/16" (24mm)	3/8" (9.5mm)		Black	529
18327	5	11/16" (17.5mm)	5/8" (16mm)	1/4" (6.4mm)		Black	506
18334	6	1" (25.4mm)	1-3/4" (44.5mm)	1/2" (12.7mm)		Gray	530
18353	9	9/16" (14.3mm)	41/64" (16.3mm)	1/4" (6.4mm)		White	497
18394	3	1" (25.4mm)	1-1/8" (28.5mm)	1/4" (6.4mm)		Black	530
18503	6	1" (25.4mm)	1" (25.4mm)	5/16" (8mm)		Black	529
18873	3	18mm	28mm	9mm		Black	513
18888	4	20mm	8mm*	7mm		Black	515
18893	1	11/16" (17.5mm)	1/2" (12.7mm)	1/4" (6.4mm)		Black	505
18894	1	11/16" (17.5mm)	3/4" (19mm)	1/4" (6.4mm)		Black	506
18895	1	11/16" (17.5mm)	1-3/32" (28mm)	1/4" (6.4mm)		Black	506
18896	3	20mm	28mm	8mm		Black	524
18939	2	18mm	23mm	9mm		Black	512
18951	1	20mm	26mm	8mm		Black	523
19013	4	15mm	10mm	7mm		Black	498
19118	4	20mm	10mm	8mm		Black	517
19128	1	20mm	9mm	7mm		Black	516
19140	1	20mm	21mm	8mm		Black	522
19142	1	15mm	13mm	7mm x 7mm		Black	499
19186	4	11mm	10mm	8mm		Black	492
19195	7	16mm	12mm	8mm		Black	502
19219	Misc.	15mm	27mm	9mm		Black	501
19231	8	18mm	12mm	8mm		Black	510
19232	1	17mm	13mm	7mm		Black	504
19233	4	20mm	13mm	10mm		Black	519
19239	4	20mm	11mm	8mm		Black	518
19242	2	13/32" (10.3mm)	11/16" (17.5mm)	7/32" (5.6mm)		Black	492
19243	1	16mm	10mm*	9mm		Black	501
19244	6	1" (25.4mm)	11/16" (17.5mm)	1/4" x 1/4" (6.4mm x 6.4mm)		Black	528
19245	3	3/4" (19mm)	1-1/8" (28.5mm)	1/4" (6.4mm)		Black	514

\*Not including the pin

**Sec. 19**

**PUSH-TYPE RETAINER SPECIFICATION CHART**

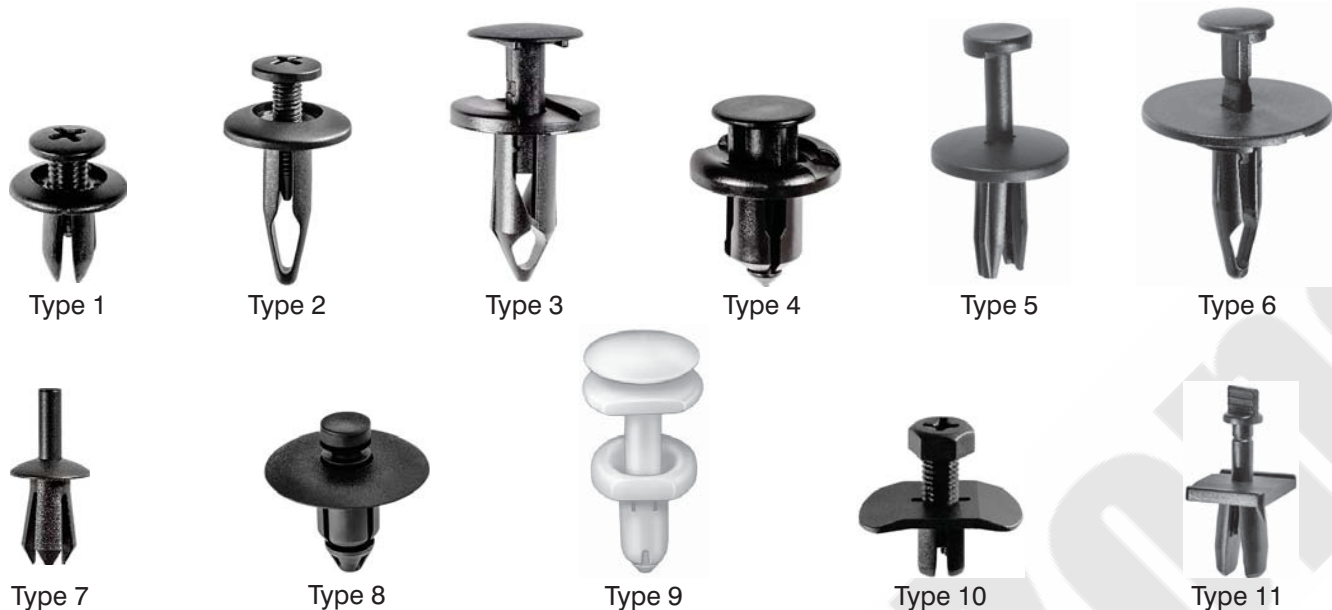

Auveco Part No.	Type	Head Diameter	Stem Length	Fits in Hole Size	Shoulder Length	Color	Page No.
19246	4	18mm	15mm	10mm		Black	510
19248	7	16mm	14mm	6mm		Black	503
19274	4	20mm	9mm*	8mm		Black	516
19297	8	16mm	12mm*	7mm		Black	502
19306	1	16mm	12mm	6mm		Black	502
19311	1	15mm	13mm	6mm		Black	499
19315	1	20mm	9mm*	8mm		Black	516
19337	Misc.	14mm	23mm	6.3mm		Black	497
19355	6	17/32" (13.5mm)	1-5/64" (27.5mm)	1/4" (6.4mm)		Black	496
19407	2	20mm	27mm	10mm		Black	524
19408	2	20mm	24mm	10mm		Black	523
19416	8	18mm	12mm*	9mm		Black	510
19422	4	23/32" (18.3mm)	29/32" (23mm)	5/16" (8mm)		Black	513
19453	4	18mm	15mm*	8mm		Black	510
19490	1	18mm	8mm	6mm		Black	507
19511	9	29/32" (23mm)	11/16" (17.5mm)	3/8" (9.5mm)		White	501
19522	3	12mm	18mm	6mm x 6mm		Black	494
19546	1	17mm	16mm	7mm x 7mm		Black	505
19547	4	17mm	13mm*	9mm		Black	504
19552	1	16mm	9mm	7mm		Black	501
19607	7	16mm	12mm	10mm		Natural	502
19615	3	20mm	21mm	9mm		Black	522
19638	Misc.	34mm	20mm	8mm	3mm	Black & White	531
19639	3	17mm	16mm	6mm		Black	505
19645	1	14mm	8mm*	6mm		Gray	496
19726	1	14mm	8mm*	6mm		Black	496
19739	2	20mm	26mm	9mm		Black	523
19747	1	18mm	10mm	8mm		Black	507
19787	2	12mm	17mm	6mm		Black	494
19788	2	11mm	20mm	6mm		Black	493
19801	3	19/32" (15mm)	3/4" (19mm)	1/4" (6.4mm)		Black	500
19847	5	7/8" (22mm)	25/32" (20mm)	1/2" (12.7mm)	5/32" (4mm)	Blue	525
19849	2	18mm	18mm	8mm		Black Nylon & Santoprene Rubber	511
19854	5	7mm	10mm	5mm		Black	490
19892	8	27mm	18mm*	10mm	7mm	Black	530
19904	7	16mm	14mm	9mm		Black	503

\*Not including the pin

# PUSH-TYPE RETAINER SPECIFICATION CHART

## Sec. 19

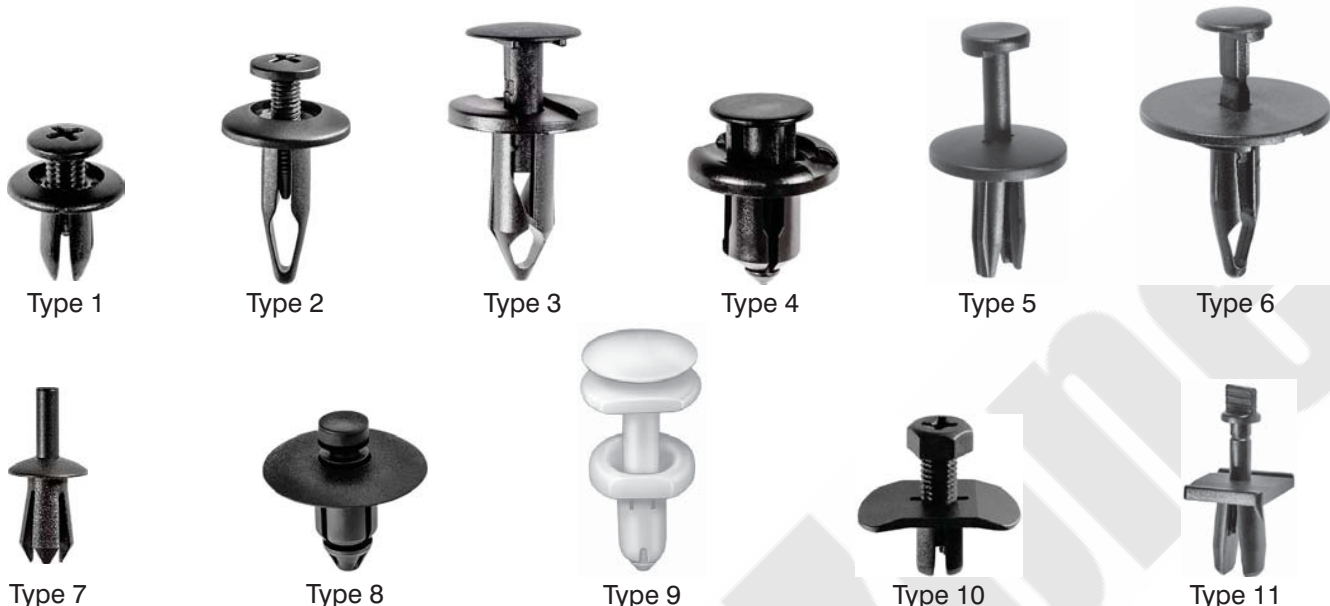

Auveco Part No.	Type	Head Diameter	Stem Length	Fits in Hole Size	Shoulder Length	Color	Page No.
19905	1	20mm	8mm*	8mm		Black	515
19907	1	20mm	8mm*	7mm		Gray	515
19908	1	20mm	8mm*	7mm		Black	515
20163	Misc.	12.5mm	17mm	6mm		Black	495
20169	9	15mm	13mm	7mm		White	499
20187	7	10mm	10mm	6mm		Black	491
20196	1	14mm	8mm	6mm		Black	496
20203	Misc.	11mm x 14mm	8mm	7mm x 8mm		Black	532
20233	8	25mm	12mm*	9mm	3mm	Black	527
20234	5	15mm	15mm	6.3mm		Black	500
20244	9	19mm	32mm	8mm		Green with Sealer	515
20247	4	18mm	12mm	9mm		Black	509
20248	5	20mm	17mm	6.3mm		Black	521
20265	2	1" (25.4mm)	1" (25.4mm)	1/4" (6.4mm)		Black	529
20270	5	20mm	9mm	7mm		Black	516
20273	8	19mm	22mm	9mm	7mm	Gray	514
20310	7	5/8" (16mm)	7/16" (11mm)	1/4" (6.4mm)		Black	502
20314	7	13mm	14mm	8mm		Black	496
20327	4	18mm	22mm	9mm		Black	512
20335	4	18mm	7mm	7mm		Black	507
20348	2	20mm	22mm	8mm		Black	523
20349	4	18mm	12mm	8mm		Black	508
20352	2	16mm	21mm	8mm		Black	504
20359	6	18mm	26mm	10mm		Black	513
20363	9	20mm	12mm*	9mm		White	499
20365	4	18mm	13mm	7.5mm x 7.5mm		Black	509
20367	2	18mm	18mm	8mm		Black	511
20388	1	20mm	16mm	7mm		Black	521
20407	11	8mm x 25mm	10mm	5mm		Black	532
20457	3	21mm	23mm	9.5mm		Black	524
20458	6	20mm	17mm	7mm		Black	521
20465	1	18mm	9mm	8mm		Black	507
20516	1	20mm	13mm	8mm		Black	519
20518	Misc.	24.5mm	14mm*	9mm		Black	527
20542	6	16.5mm	27mm	8mm		Black	504
20545	2	18mm	18mm	6.3mm		Black Nylon & Santoprene Rubber	510
20564	4	20mm	18mm	10mm		Black	522

\*Not including the pin

**Sec. 19**

**PUSH-TYPE RETAINER SPECIFICATION CHART**



Auveco Part No.	Type	Head Diameter	Stem Length	Fits in Hole Size	Shoulder Length	Color	Page No.
20577	1	20mm	8mm*	7mm		Black	515
20580	4	14mm	12mm	7mm		Black	499
20608	4	20mm	14mm	10mm		Black	520
20613	2	18mm	20mm	9mm		Black	511
20631	6	18mm	26mm	10mm		Black	512
20632	3	20mm	26mm	8mm		Black	523
20636	5	12mm	10mm	8.5mm		Dark Gray	493
20637	5	20mm	9mm	8mm		Black	516
20638	5	20mm	14mm	8.5mm		Black	520
20639	1	12mm	11mm	5mm x 5mm		Black	494
20640	1	12mm	11mm	5mm		Black	494
20666	8	12mm	14mm*	6mm		Gray	494
20734	7	20mm	15mm	6.3mm		Black	520
20739	8	22mm	10mm*	9mm		Black	524
20753	2	22mm	21mm	8mm		Black	526
20755	4	19.5mm	15mm	10mm		Black	515
20766	7	20mm	16mm	10mm		Black	521
20767	Misc.	24mm	20mm	11mm	3mm	Black & White	526
20768	4	18.5mm	21mm	8mm		Black with Sealer	513
20826	3	19mm	14mm	8.5mm		Black	514
20863	4	22mm	13mm*	15mm		Black	525
20869	4	18mm	7.5mm	7mm		Black	507
20880	3	18mm	20mm	6.5mm		Black	511
20888	3	18mm	20mm	9.5mm		Black	512
20889	3	20mm	22mm	8.5mm		Black	523
20890	Misc.	25mm x 45mm	20mm	9.5mm	3mm	Black & Natural	533
20892	10	14mm x 26mm	14mm	8mm		Black	532
20908	4	20mm	10mm	7mm		Black	517
20909	6	16mm	18mm	7mm		Black	503
20910	8	17mm	12mm	8mm		Black	504
20923	10	8.5mm x 12mm	9mm	5mm		Black	532
20931	3	18mm	31mm	9mm		Black	513
20943	2	14mm	23mm	7mm		Black	497
20948	8	22mm	10mm*	9mm		Tan	525
20953	4	20mm	13mm	8mm		Black	519
20963	Misc.	34mm	17mm	8.5mm	3.5mm	Black & White	531
20966	4	18mm	20mm	8mm		Black	511
20967	7	22mm	16mm	10mm		Black	525
20986	4	20mm	13mm	10mm		Black	519
20988	3	18mm	17.5mm	6.5mm		Black	510
20989	3	18mm	22mm	6.5mm		Black	512

\*Not including the pin

# PUSH-TYPE RETAINER SPECIFICATION CHART

## Sec. 19

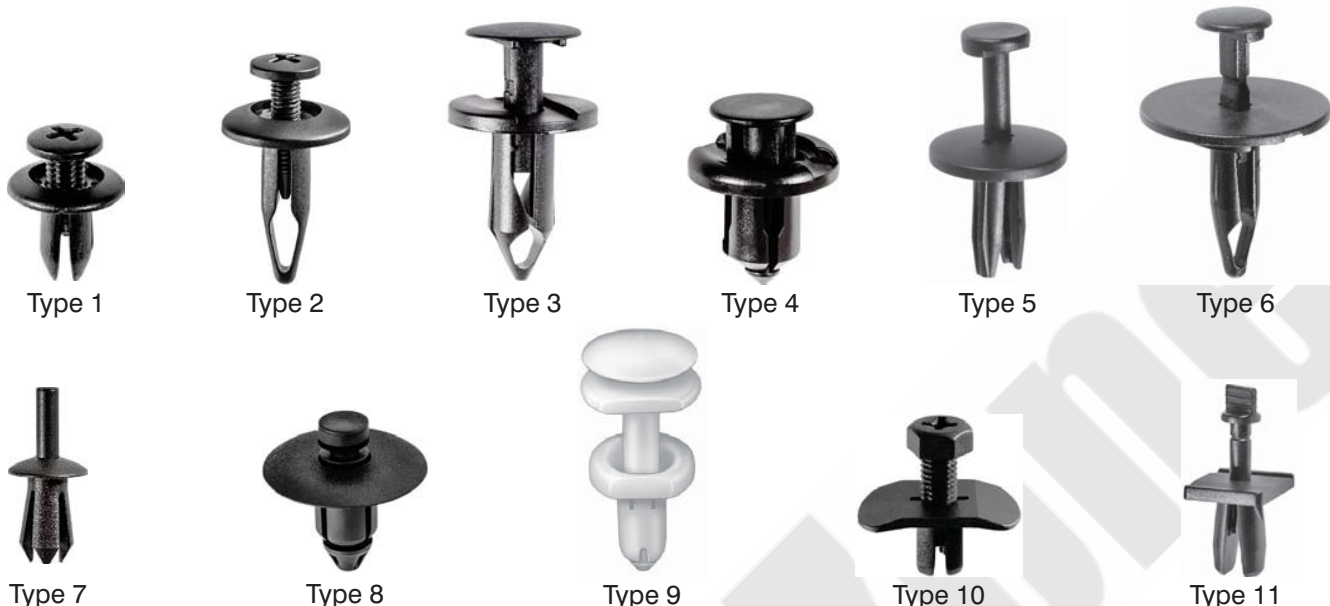

Auveco Part No.	Type	Head Diameter	Stem Length	Fits in Hole Size	Shoulder Length	Color	Page No.
20990	3	19mm	16mm	8mm		Black	514
20991	3	20mm	20mm	8.5mm		Black	522
20992	3	20mm	24mm	8.5mm		Black	523
20993	3	25mm	20mm	10.5mm		Black	528
20994	3	25mm	23mm	10.5mm		Black	528
21010	1	20mm	9mm	9mm x 9mm		Black	516
21011	4	15mm	17mm	7mm		Black	500
21021	8	22mm	10mm*	9mm		Gray	524
21024	4	18mm	10mm	6mm		Black	507
21037	7	10mm	10mm	6mm		Black	491
21044	1	16mm	11mm	6.3mm		Black	502
21086	5	20mm	10mm	8mm		Black	517
21089	1	18mm	18mm	8mm		Black	510
21098	1	18mm	18mm	6.4mm		Black	510
21103	1	10mm	12mm	5mm		Black	491
21104	1	14mm	14mm	7mm		Black	497
21110	8	18mm	12mm	8.5mm		Black	509
21112	2	15mm	14mm	6mm		Black	499
21119	2	20mm	19mm	6mm		Black	522
21120	8	15mm	9mm*	7mm		Black	499
21123	4	18mm	12mm*	8mm		Black	511
21134	8	20mm	11mm*	8mm		Black	520
21140	8	15mm	12mm	6.3mm		Black	498
21141	9	18mm	13mm	8mm		Black & White	509
21146	1	18mm	12mm	8mm		Black	508
21172	1	13mm	18mm	8mm		Black With Sealer	496
21173	4	20mm	16mm	10mm		Black	521
21176	Misc.	24.5mm	13mm*	9mm		Black	527
21190	8	16mm	14mm	7mm		Black	503
21192	4	20mm	12mm	8mm		Black	518
21201	4	19mm	8mm	7mm		Black	513
21218	1	11mm	8mm	5mm		Black	492
21225	5	18mm	14mm	7mm		Black	509
21233	2	10mm	13mm	5mm		Black	491
21238	7	26mm	12mm	10mm		Black	530
21246	8	12mm	14mm*	6mm		Black	494
21249	8	11mm	9mm*	7mm		Black	492
21251	Misc.	22.5mm	8mm*	8mm		Black & White	526
21294	4	20mm	9mm	7mm		Black	516
21297	4	20mm	11mm	10mm		Black	518
21311	1	18mm	12mm	8mm		Gray	508
21325	1	16mm	14mm	7mm		Black	503

\*Not including the pin

**Sec. 19**

**PUSH-TYPE RETAINER SPECIFICATION CHART**



Auveco Part No.	Type	Head Diameter	Stem Length	Fits in Hole Size	Shoulder Length	Color	Page No.
21328	8	15mm	10mm	7mm		Black	498
21348	Misc.	20mm	23mm	10mm		Black	531
21361	6	25mm	29mm	7mm		Black	528
21366	4	22mm	15mm*	9mm		Black	525
21376	Misc.	24mm	20mm	11mm	3mm	Black & White	527
21391	7	12mm	11mm	8mm		Dark Gray	493
21400	Misc.	23.5mm	36mm	10mm		Natural	527
21420	4	21mm	15mm*	10mm		Black	524
21422	4	20mm	9mm*	7mm		Black	516
21427	8	22mm	10mm*	9mm		Gray	524
21451	4	14mm	10mm	8.5mm		Black	496
21452	1	16mm	15mm	8mm x 8mm		Black	526
21454	Misc.	20mm	13mm	10mm		Black	520
21477	8	16mm	14mm	7mm		Gray	503
21479	1	18.5mm	11mm	9mm		Gray	513
(Allen Drive)							
21482	1	24mm	13mm	9mm x 9mm		Black	526
21500	1	20mm	12mm	7mm		Black	518
(Slotted Drive)							
21501	4	25mm	12mm*	11mm	3mm	Black with Sealer	527
21525	8	19mm	9mm	7mm		Black	513
21529	3	18mm	22mm	6.5mm		Black with Sealer	512
21530	1	18mm	10mm	8mm		Black	507
21545	1	20mm	15mm	8mm		Black	520
21547	4	18mm	10mm	9mm		Black	508
21563	4	20mm	15mm	10mm		Black	521
21566	1	16mm	13mm	7mm		Black	502
21568	Misc.	14mm	15mm	10mm		Black	515
21570	1	16mm	11mm	6mm		Black	501
21571	1	20mm	10mm	8mm		Black	517
21576	4	25mm	16mm*	11mm	3mm	Black with Sealer	527
21578	2	22mm	28mm	10mm		Black	526
21580	1	20mm	12mm	7mm		Black	518
21585	5	9mm	7mm	4mm		Black	490
21592	1	20mm	11mm	7mm		Black	518
(Slotted Drive)							
21593	1	15mm	8mm	7mm		Black	497
21594	1	20mm	11mm	7mm		Black	517
21596	4	20mm	16mm	8mm		Black	521
21601	9	22mm	16mm	9mm		White Nylon & Black Rubber Seal	503
21620	2	15mm	14mm	5mm		Black	499

\*Not including the pin

# PUSH-TYPE RETAINER SPECIFICATION CHART

## Sec. 19

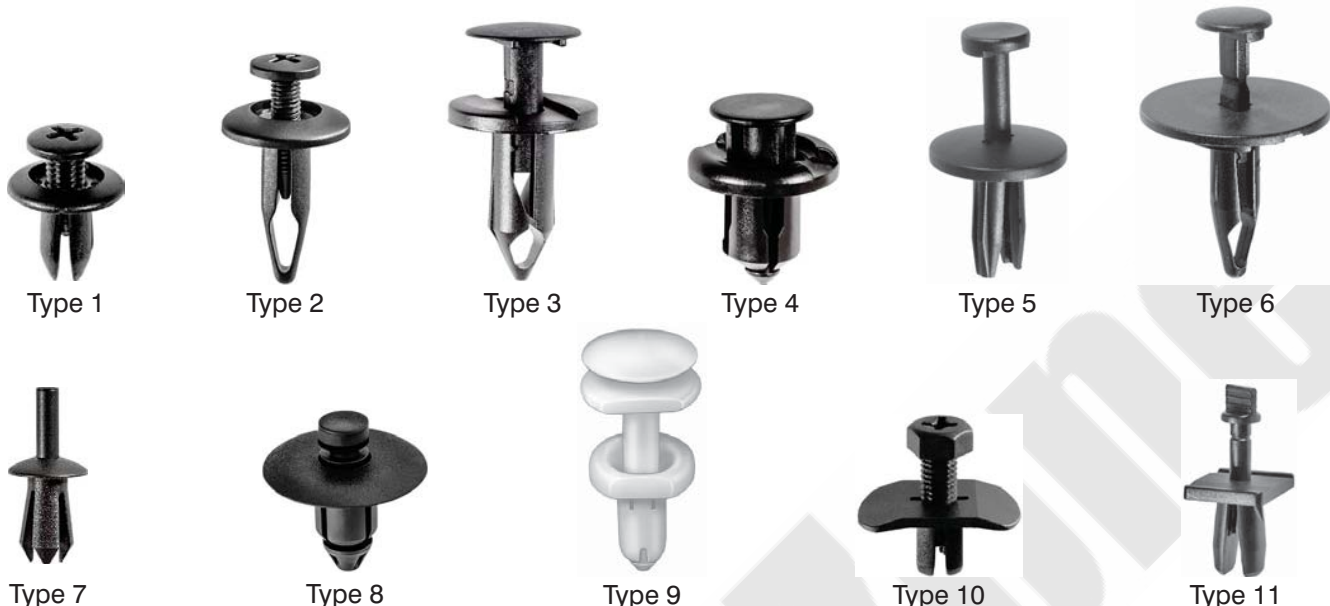

Auveco Part No.	Type	Head Diameter	Stem Length	Fits in Hole Size	Shoulder Length	Color	Page No.
21624	1	16mm	10mm	8mm		Black	501
21631	4	20mm	8mm*	8mm		Black	515
21645	7	15mm	15mm	6.3mm		Black	500
21651	4	20mm	10mm	8mm		Black	517
21658	4	15mm	11mm	6mm		Black	498
21662	8	11mm	11mm	7mm		Black	492
21663	1	10mm	9mm	5mm		Black	491
21672	6	18mm	20mm	6.3mm		Black with Sealer	511
21680	4	18mm	10mm	8mm		Black	507
21702	4	18mm	12mm	10mm		Black	509
21703	Misc.	18mm	12mm	7mm		Black	508
21711	6	11mm	16mm	6mm		Black Nylon & Santoprene Rubber	493
21769	1	13mm	13mm	8mm		Black	495
21778	5	20mm	21mm	8.5		Black	522
21779	7	10mm	11mm	6.3mm		Black	491
21780	7	9mm	7mm	5mm		Black	490
21781	5	20mm	16mm	6.3mm		Black	521
21807	1	18mm	14mm	8mm		Black	509
21810	1	22mm	14mm	6.3mm		Black	525
21811	8	20mm	10mm	8mm		Black	517
21812	Misc.	20mm	13mm	8mm		Black	519
21849	4	13mm	15mm	5.5mm		Black	496
21856	4	20mm	12mm	10mm		Black	518
21858	5	18mm	14mm	6mm		Black	509
21859	7	16mm	11mm	8mm		Black	502
21860	4	22mm	14mm	13mm		Black	525
21875	5	12.5mm	9mm	6mm		Black	494
21876	3	18mm	18mm	9mm		Black	511
21881	7	10mm	12mm	6.3mm		Black	491
21882	5	12mm	14mm	6mm		Black	494
21883	5	20mm	14mm	8mm		Black	520
21898	8	17.5mm	9mm	6mm		Black	505
21935	4	12mm	10mm	6mm		Black	493
21967	7	8mm	7mm	3.5mm		Black	490
21968	7	8mm	8mm	4mm		Black	490
21969	7	16mm	10mm	6mm		Black	501
21970	7	13mm	10mm	6mm		Black	495
21971	7	16mm	14mm	9mm		Black	503
21972	7	10.5mm	6mm	6mm		Black	492
21973	Misc.	20mm	10mm	6mm		Tan	517

\*Not including the pin

**Sec. 19**

**PUSH-TYPE RETAINER SPECIFICATION CHART**



Auveco Part No.	Type	Head Diameter	Stem Length	Fits in Hole Size	Shoulder Length	Color	Page No.
21989	7	11mm	7mm	7mm		Black	492
21990	5	15mm	8mm	7mm		Black	497
22039	4	16mm x 19mm	12mm	8mm		Black	518
22041	3	14mm x 21mm	16mm	8mm		Black	532
22047	4	25mm	9mm*	8mm		Gray & Black	527
22049	2	18mm	20mm	9mm		Black	511
22052	5	20mm	17mm	6.3mm		Black	521
22058	8	14mm	9mm	7mm		Black	496
22068	4	20mm	13mm	8.5mm		White	519
22069	4	20mm	13mm	8.5mm		White	519
22072	4	38mm	32mm	22mm		Black	531
22077	1	18mm	9mm	9mm		Black	507
22083	4	16mm	10mm	8mm		Black	501
22095	7	22mm	13mm	8mm		Black	525
22100	4	20mm	12mm	8.5mm		Black	519
22101	7	22mm	12mm	7.5mm		Black	525
22112	4	20mm	13mm	8.5mm		Black	519
22125	4	10mm	10mm	5mm		Black	491
22126	6	19mm	28mm	9mm		Black	514
22155	7	13mm	13mm	8mm		Black	495
22160	8	15mm	10mm	7mm		Black	498
22177	Misc.	16mm	13mm	9mm		Yellow & White	502
22178	4	13mm	10mm	7mm		Black	495
22181	4	18mm	10mm	8mm		Black	507
22199	1	15mm	12mm	6.3mm		Black	498
22201	5	12.5mm	12mm	8.5mm		Black	494
22219	3	18mm	23mm	7.5mm		Black	512
22227	3	18mm	20mm	7mm		Black	511
22230	8	10mm	8.5mm	5mm		Black	490
22234	Misc.	16mm	11mm	8mm		Black	502
22238	5	10mm	11mm	5mm		Black	491
22248	5	19mm	12mm	8mm		Black	513
22253	5	18mm	14mm	8mm		Black	509
22256	1	24mm	12mm	12mm		Black	526
22270	4	20mm	10mm	8mm		Black	517
22280	10	10mm	11mm	5mm		Black	498
22282	8	22mm	25mm	8mm		Gray	526
22284	6	25mm	24mm	8.5mm		Black	528
22299	2	20mm	26mm	9.5mm		Black	523
22303	1	12mm	13mm	7mm		Black	494
22306	5	20mm	10mm	8mm		Black	517
22339	1	30.5mm	17mm	8.5mm		Black	531
22347	3	15mm	21mm	8mm		Black	500
22349	3	14mm	18mm	8mm x 11mm		Black	497
22354	3	18mm	18mm	7mm		Black	510

\*Not including the pin



**15301**

**Clip Removal Tool**

*Photos not actual size*

The right tool for removing clips and retainers quickly and easily. Simply seat the tool on the shaft of the fastener and squeeze the handles together.

Made of high carbon steel and heat treated for strength. Zinc plated with vinyl molded handle grips.

UNIT PACKAGE: 1

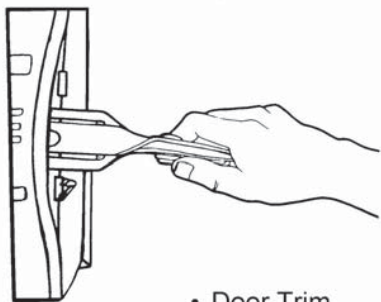

• Door Trim

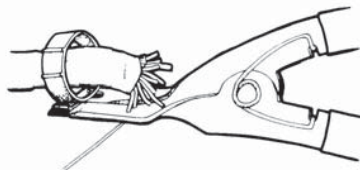

• Wiring Stays

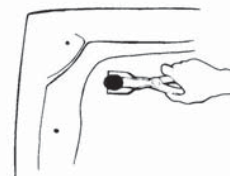

• Hood Insulation

**Truck Seat Springs**

**16213**

(E0TB-1063-226AC,  
E3TB-1063-226AA)

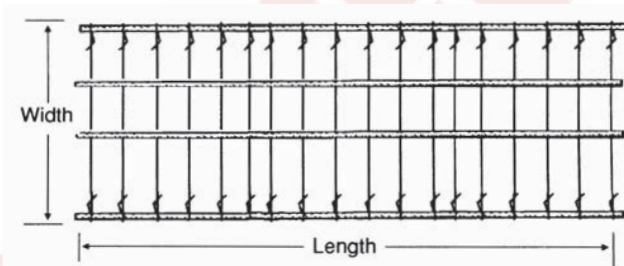

*Photo not actual size*

Length: 52"  
Width: 16-3/4"  
Number of Wires: 52  
Ford Full Size Pick-Ups &  
Light Truck 1980-On

UNIT PACKAGE: 5

**Wire Bending Tool**

**16894**



*Photo not actual size*

For truck seat springs

A tough tool that makes difficult wire repairs easy. You can bend the ends of no sags, edgewise and foam springs right on the spot, making offsets where you need them. Can be readily mounted in a vise for duplicating complex repetitive wire bends. Constructed of heat-hardened steel for long life.

UNIT PACKAGE: 1

**Sec. 20**

**GENERAL MOTORS CLIPS & FASTENERS**



**17000**  
(16506582)

Horizontal Headlight Adjuster  
Chevrolet Corsica & Lumina (APV),  
Olds Silhouette (APV)  
and Pontiac Trans Sport (APV)  
1987-On

Photo not  
actual size

UNIT PACKAGE: 2



**10759**

(GM: 1600375, 1606642, 1618890;  
AMC: SF 400 6204)

1/4"-28 x 1-7/8"  
Headlight Adjusting Screw &  
Nut Assembly  
Cadillac & Oldsmobile 1975-On  
AMC

UNIT PACKAGE: 10

**11470**

Same as 10759 except for  
unit package quantity

UNIT PACKAGE: 25

**11657**

Same as 10759 except for  
unit package quantity

UNIT PACKAGE: 100



**11243**

(343543, 343555,  
354076, 362379)

1/4"-28 x 2"  
Headlight Adjusting Screw &  
Nut Assembly  
GM 1962-On

UNIT PACKAGE: 10

**11244**

Same as 11243 except for  
unit package quantity

UNIT PACKAGE: 100



**11826**

(365270)  
Green Nylon

1/4"-28 x 2"  
Headlight Adjusting Screw &  
Nut Assembly  
Cars with Fiberglass Panels  
GM 1976-On

UNIT PACKAGE: 25



**11245**

(343543, 343555, 354076, 362379)  
Nylon

Headlight Adjusting Nut  
GM 1962-On

UNIT PACKAGE: 50



**11718**

(365270)  
Green Nylon

Headlight Adjusting Nut  
For Cars with Fiberglass Panels  
GM 1976-On

UNIT PACKAGE: 50



**11246**

(343543, 354076, 9438150, 15705372)  
Zinc

1/4"-28 x 2"  
Headlight Adjusting Screw  
GM 1962-On

UNIT PACKAGE: 25

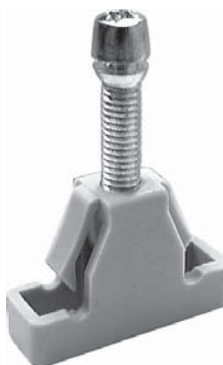

**11665**

(556196, 557057)  
Nylon

#12-28 x 1-3/4"  
Headlight Adjusting Screw  
& Nut Assembly  
GM 1975-On

UNIT PACKAGE: 25



### 11655

(557057, 559312)  
Nylon

#12-28 x 1-3/4"  
Headlight Adjusting Screw &  
Nut Assembly  
GM 1975-On

UNIT PACKAGE: 25

### 11656

Same as 11655 except for  
unit package quantity

UNIT PACKAGE: 100



### 11667

(556539)  
Nylon

#12-28 x 1-3/4"  
Headlight Adjusting Screw &  
Nut Assembly  
Buick & Oldsmobile 1977-On

UNIT PACKAGE: 25



### 12605

(22512857, 22513813)  
Nylon

#12-28 x 1-3/4"  
Headlight Adjusting Screw &  
Nut Assembly  
Camaro & Firebird 1975-On

UNIT PACKAGE: 10

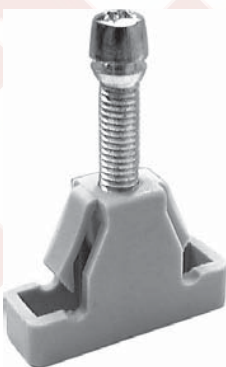

### 11871

(559312)  
Nylon

#12-28 x 1-11/16"  
Headlight Adjusting  
Screw & Nut Assembly  
Chevrolet, Oldsmobile &  
Pontiac 1975-On

UNIT PACKAGE: 10



### 9851

(3921446)  
White Nylon

Headlight Adjusting Nut  
Use with 1/4"-28 Screw  
Chevrolet

UNIT PACKAGE: 50



### 5788

Nylon

Headlight Adjusting Nut  
Chevrolet: All Early Models

UNIT PACKAGE: 50

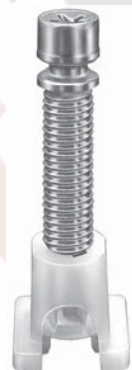

### 5789

Headlight Adjusting Screw &  
Nut Assembly  
Chevrolet

UNIT PACKAGE: 25 Sets



### 3209

Zinc

1/4"-28 x 1"  
Headlight Adjusting Screw

UNIT PACKAGE: 50



### 3178

(5949838)

Headlight  
Adjusting Screw &  
Nut Assembly  
Chevrolet, Buick &  
Pontiac

UNIT PACKAGE: 10 Sets

**Sec. 20**

**GENERAL MOTORS CLIPS & FASTENERS**



**20378**  
(Not Supplied by O.E.M.)  
White Nylon

Headlight Adjusting Screw Nut  
**Component of Auveco 3178**  
Headlight Adjusting  
Screw Assembly  
Buick, Chevrolet & Pontiac

UNIT PACKAGE: 25



**15676**  
(16510893)  
Natural Nylon

Composite Headlight Nut  
Screw Size: #6  
Square Head: 3/8"  
Buick Electra (FWD) 1987-On

UNIT PACKAGE: 50



**9829**  
(380382)  
Natural Nylon

Headlight Bezel to Body Nut  
Screw Size: #6 or #8  
GM

UNIT PACKAGE: 50



**14002**  
(16503329)  
Black Nylon

Screw Size: #6  
Square Head: 3/8"  
Fits 1/4" Square Hole  
GM

UNIT PACKAGE: 100



**11838**  
(1254815)  
Natural Nylon

Screw Size: #6  
Panel Range: .060"-.150"  
GM 1977-On

UNIT PACKAGE: 50



**13450**  
(347347)  
Natural Nylon

Front Lights  
Screw Size: #8  
Panel Range: 1/16"-5/32"  
GM 1967-On

UNIT PACKAGE: 50



**10330**  
(3893980)  
Natural Nylon

Front End & Instrument Panel Nut  
Screw Size: #8  
GM 1967-On

UNIT PACKAGE: 100



**19486**  
(10298115)  
Natural Nylon

Headlight Retainer  
Width: 1-1/8"  
Length: 4-9/16"  
Buick Century & Regal and  
Oldsmobile Intrigue 1997-On

UNIT PACKAGE: 10



**20864**  
(15281294)  
White Nylon

Headlight Retainer  
Width: 1-1/8"  
Length: 5-9/16"  
Chevrolet Impala & Monte Carlo 2006 - On

UNIT PACKAGE: 10



**10090**  
(3923948)

Headlight  
Adjusting Spring  
Chevrolet 1968-On

UNIT PACKAGE: 25



**8942**  
(3863669)  
Nylon

Radiator Grille to Headlight Nut  
Screw Size: #8 or #10  
Chevrolet

UNIT PACKAGE: 25



**11691**

(3919773)  
Natural Nylon

Headlight Bezel Nut  
Screw Size: #8  
GM 1974-On

UNIT PACKAGE: 100



**11424**

(3985058)  
Natural Nylon

Truck Grille Nut  
Screw Size: #6 or #8  
GM Trucks 1974-On

UNIT PACKAGE: 25



**11855**

(GM: 9669486;  
Renault: 8934-201-262)  
Natural Nylon

Side Marker Nut  
GM 1980-On  
Rear License Plate Bracket  
Screw Size: #8  
AMC/Renault

UNIT PACKAGE: 25



**13960**

(14013246)  
Natural Nylon

Headlight Bezel Nut  
Screw Size: #8  
Fits into 5/16" Hole  
GM 1967-On

UNIT PACKAGE: 50



**14031**

(12337852, 15596279, 21035018)  
Black Nylon

Grille Retainer & Cowl Vent Nut  
Screw Size: #8 or #10  
Astro, Safari & Saturn 1985-On

UNIT PACKAGE: 25



**14014**

(GM: 20475950, 20624923;  
VW: 175-853-674)  
Black Nylon

Air Vent Nut  
GM & VW

UNIT PACKAGE: 50



**13933**

Natural Nylon

Grille Nut  
Screw Size: #8 or #10  
Head Size: 1/2"

UNIT PACKAGE: 50



**12735**

(GM: 1370853; Chry: 6029501;  
VW: 179-813-883)  
Natural Nylon

Headlight Bezel Nut  
Screw Size: #6  
GM, Chrysler & VW 1982-On

UNIT PACKAGE: 50



**10305**

Natural Nylon

Nylon Nut  
Screw Size: #8

UNIT PACKAGE: 50



**14145**

(16503548)  
Nylon &  
Stainless Steel

Headlight Glass nut  
GM 1983-On

UNIT PACKAGE: 25



**9069**

(1355003)  
Natural Nylon

Headlight Door to  
Radiator Grille Anchor Nut  
Screw Size: #6 or #8  
Buick 1964-On

UNIT PACKAGE: 50



**14030**

(GM: 3997391; VW: 179-813-881)  
Black Nylon

Tail Light Nut  
Screw Size: #8  
GM Astro & Safari 1985-On  
Volkswagen

UNIT PACKAGE: 25

Sec. 20

GENERAL MOTORS CLIPS & FASTENERS



**21347**  
(10351052)  
White Nylon

Trim Panel Grommet with Sealer  
Head Size: 12mm x 14.5mm  
Stem Length: 15mm  
Fits into 7mm Hole

**Mates with Auveco 21346**  
Cadillac, Chevrolet Camaro &  
Corvette and Pontiac Firebird 2004 - On

UNIT PACKAGE: 15



**19676**  
(10277480)  
Natural Nylon

License Plate Cover  
Screw Grommet  
Screw Size: M4.2 (#8)  
Head Diameter: 9/16"  
Stem Length: 9/16"  
Fits into 1/4" Square Hole  
Oldsmobile Intrigue 1998 - On

UNIT PACKAGE: 15



**17271**  
(94113207)  
Natural Nylon

Cowl Cover Retaining Clip  
Head Diameter: 23mm  
Chevrolet Spectrum 1989-85

UNIT PACKAGE: 15



**17230**  
(10027015)  
Natural Nylon

Screw Grommet for  
Engine Control Module  
Overall Length: 1-3/16"  
GM (All Divisions) 1977-On

UNIT PACKAGE: 10



**19247**  
(10262143)  
Black Nylon

Air Intake Grille Panel Grommet  
For 5mm Stud  
Buick Regal & Century Chevrolet Lumina  
& Monte Carlo, Oldsmobile Cutlass,  
Pontiac Grand Prix 1996-On

UNIT PACKAGE: 25



**20938**  
(11561655)  
Black Nylon

Tail Light Grommet with Sealer  
Head Diameter: 15mm  
Stem Length: 17mm  
Fits into 11mm Hole  
Buick Terraza, Chevrolet Uplander, GMC  
Arcadia, Pontiac Montana SV6  
and Saturn Relay 2005 - On

UNIT PACKAGE: 5



**22026**  
(GM: 25803643)  
Natural Nylon

Door Glass to Regulator Grommet  
Head Diameter: 13.5mm  
Overall Length: 14mm  
Buick Allure, LaCrosse & Verano and  
Chevrolet Malibu 2010 - On

UNIT PACKAGE: 25



**19194**  
(Toyota: 90189-06028; GM: 94854203)  
Black Nylon

Front & Rear Wheel  
Fender Liner Screw Grommet  
Screw Size: #12  
Head Diameter: 16mm  
Stem Length: 19mm  
Fits into 9mm x 9mm Square Hole  
Tacoma, T100 & 4 Runner 1992 - On  
Chevrolet Nova & Prizm  
and Pontiac Vibe 1985 - On

UNIT PACKAGE: 15



**21674**  
(11570830)  
White Nylon

Fog Light Grommet  
Head Diameter: 16mm  
Stem Length: 16mm  
Overall Length: 20mm  
Fits into 11mm Hole  
Cadillac Escalade, Chevrolet Avalanche, Camaro,  
Colorado, Silverado & Tahoe and GMC  
Canyon, Denali, Sierra & Yukon 2005 - On

UNIT PACKAGE: 15

# GENERAL MOTORS CLIPS & FASTENERS

## Sec. 20



**19429**  
(15954398)  
Rubber

Tail Light Screw Grommet  
Venture, Silhouette, Transport,  
S & T Trucks 1995-On

UNIT PACKAGE: 25



**11865**  
(GM: 1255823; Ford: 389360S)  
Natural Nylon

Front End Bezel Nut  
Screw Size: #6 or #8  
GM 1979-On  
Tail Light Nut  
Ford 1981-On

UNIT PACKAGE: 50



**20452**  
(11517873)  
Natural Nylon

Screw Grommet  
Use with #12 Screw  
Head Size: 5/8" x 3/4"  
Stem Length: 9/16"  
Door Handle  
Chevrolet Impala & Monte Carlo 2000 - On

UNIT PACKAGE: 15



**21428**  
(25704358)  
White Nylon

Rear Bumper Screw Grommet with Sealer  
Screw Size: M6.3 (1/4" or #14)  
Head Size: 15mm x 18mm  
Stem Length: 23mm  
Cadillac CTS & SRX and  
Pontiac Grand Prix 2004 - On

UNIT PACKAGE: 10



**14037**  
(GM: 15596280; Chry: 6035274)  
Black Nylon

Cowl Vent Nut  
Screw Size: #6 or #8  
GM Astro & Safari 1985-On

UNIT PACKAGE: 25



**12713**  
(GM: 10032838, 1264963;  
Chry: 6031869; AMC: 8934-201-602)  
Nylon

High Torque Screw Grommet  
Screw Size: #6  
GM, Chrysler & AMC-Renault 1978-On

UNIT PACKAGE: 25



**10365**  
(1377030)  
Natural Nylon

Valance Panel to Rear  
Bumper Bar Grommet  
Screw Size: #6 or #8  
GM 1971-On

UNIT PACKAGE: 100



**19435**  
(25526447)  
Natural Nylon

Radiator Screw Grommet  
Screw Size: #6  
Buick Century 1996 - 86

UNIT PACKAGE: 50



**14009**  
(14032291)  
Natural Nylon

Grille Attachment Grommet  
Screw Size: #6 or #8

UNIT PACKAGE: 50



**14220**  
(25525798, 22537749)  
Natural Nylon

Grille Retaining Grommet  
Screw Size: #8  
GM 1985-On

UNIT PACKAGE: 50



**20466**  
(GM: 25649667;  
Ford: W705590-S300, W710459-S300)  
Natural Nylon

Screw Grommet with Sealer  
Screw Size: M4.2 (#8)  
Head Size: 13mm x 22mm  
Stem Length: 18mm  
Back Glass Moulding & Interior Trim  
Cadillac & Ford Windstar 1998 - On

UNIT PACKAGE: 15

**Sec. 20**

**GENERAL MOTORS CLIPS & FASTENERS**



**12566**  
(GM: 25508532; Chry: 6032061)  
Black Nylon

Grille Attaching Grommet  
Screw Size: #6 or #8  
GM & Chrysler 1981-On

UNIT PACKAGE: 25



**20529**  
(15745991)  
Black Nylon

Rear Light Housing  
Upper Grommet  
Head Size: 13mm x 20mm  
Stem Length: 17mm  
Fits into 9mm x 16mm Hole  
GM Bravada, Envoy  
& Trailblazer 2002 - On

UNIT PACKAGE: 15



**19732**  
(22615352)  
Black Nylon

Front Bumper Fascia  
Hinged Pin Retainer  
**Assembles with Auveco 19733**  
Pontiac Grand Am 1999 - On

UNIT PACKAGE: 15



**21518**  
(11561987)  
Black Nylon

Tail Light Grommet with Sealer  
Head Diameter: 24mm  
Stem Length: 22mm  
Overall Length: 24.5mm  
Cadillac Escalade and  
Chevrolet Avalanche 2007 - On

UNIT PACKAGE: 15



**20635**  
(GM: 22722860)  
White Nylon

Trim Panel Grommet with Sealer  
Flange Diameter: 24mm  
Stem Length: 12mm  
Fits into 9mm Hole  
**Use with Auveco 20634**  
Oldsmobile Alero &  
Pontiac Grand Am 2002 - On

UNIT PACKAGE: 25



**19613**  
(15733971)  
Black Nylon

Front Air Deflector Retainer  
Top Head Diameter: 18mm  
Bottom Head Diameter: 26mm  
Flange Diameter: 30mm  
Stem Length: 24mm  
**Use with Auveco 19614**  
C & K Trucks 1999 - On

UNIT PACKAGE: 15



**21384**  
(11561500)  
Yellow Nylon

Trim Panel Grommet with Sealer  
Flange Diameter: 24mm  
Stem Length: 12mm  
Fits into 9mm Hole  
**Use with Auveco 21383**  
Chevrolet Traverse 2010 - On

UNIT PACKAGE: 25



**19614**  
(15733970)  
Black Nylon

Front Air Deflector Grommet  
Head Diameter: 28mm  
Stem Length: 13mm  
**Use with Auveco 19613**  
C & K Trucks 1999-On

UNIT PACKAGE: 25



**20527**  
(15745990)  
Black Nylon

Rear Light Housing  
Lower Grommet  
Head Size: 24mm x 24mm  
Stem Length: 17mm  
Fits into 15mm Hole  
GM Bravada, Envoy &  
Trailblazer 2002 - On

UNIT PACKAGE: 15



**17128**  
(10119853)  
Nylon

Body Side & End Gate  
Lower Moulding Clip  
Olds Custom Cruiser 1991-On

UNIT PACKAGE: 25



**13925**  
(20338568)  
Nylon



Outer Panel Front of Rear  
Wheel Opening Moulding Clip  
GM 1982-On

UNIT PACKAGE: 10



**18911**  
(22578985)  
Nylon

Rocker Panel  
Moulding Clip  
Buick Skylark 1993-On

UNIT PACKAGE: 10



**17545**  
(22550254)  
Nylon

Rocker Panel  
Moulding Clip  
Pontiac Grand Am SE 1992-On

UNIT PACKAGE: 25



**19361**  
(25554845)  
Nylon

Rocker Panel  
Moulding Clip  
Pontiac Bonneville 1992-On

UNIT PACKAGE: 20



**19410**  
(10261327)  
Nylon

Front & Rear Door  
Lower Moulding Clip  
Buick Century, Regal & Rendezvous  
and Pontiac Aztek & Grand Prix 1997-On

UNIT PACKAGE: 15



**11138**  
(6263345)  
Nylon

Body Side Moulding Clip  
Use with 1/8" Pop Rivet  
GM Trucks 1968-On

UNIT PACKAGE: 10



**11485**  
(1729250)  
Nylon

Roof Transverse Moulding Clip  
GM 1976-On

UNIT PACKAGE: 25

**Please place orders in  
Unit Package quantities,  
not based on pieces needed**



**14946**  
(20606417)  
Nylon

Left Outer Panel in Front of Rear  
Wheel Opening Moulding Clip  
Width: 7/8"  
Length: 1-3/16"  
Pontiac Bonneville 1989-87

UNIT PACKAGE: 25



**10220**  
(4457595, 4457495)  
Nylon

Quarter Belt &  
Wheel Opening Moulding Clip  
GM 1967 -On

UNIT PACKAGE: 50



**11288**  
(9838109)  
Gray Nylon

Body Side Moulding Clip  
Buick, Chevrolet & Oldsmobile 1967-On

UNIT PACKAGE: 100

**Sec. 20**

**GENERAL MOTORS CLIPS & FASTENERS**



**18118**  
(10135796)  
Nylon

Body Side Moulding Clip  
Buick Roadmaster 1991-On

UNIT PACKAGE: 15



**12563**  
(20175051, 15633873)  
Nylon

Quarter Belt Reveal Moulding Clip  
GM 1980-On

UNIT PACKAGE: 50



**11425**  
(1688094)  
Nylon

Vinyl Top Clip  
Used on narrow Moulding across top of roof  
Chevrolet, Cadillac & Oldsmobile 1974-On

UNIT PACKAGE: 50



**12594**  
(20171942)  
Nylon

Moulding Clip  
GM 1980-On

UNIT PACKAGE: 25



**11717**  
(1660123)  
Nylon

Belt Moulding Clip  
GM 1975-On

UNIT PACKAGE: 50



**12602**  
(20237057)  
Nylon

Moulding Clip  
GM 1980-On

UNIT PACKAGE: 25



**22228**  
GM: 11547339  
Pale Green Nylon

Belt Moulding Clip  
Width: 26mm  
Length: 43mm  
Chevrolet Silverado &  
Tahoe and GMC Sierra  
2014 - On

UNIT PACKAGE: 15



**12621**  
(14022878)  
Nylon

Moulding Clip  
GM 1980-On

UNIT PACKAGE: 25



**9850**  
(7731589)  
Natural Nylon

Quarter Panel Reveal Moulding &  
Landau Top Moulding Clip  
**Use with Auveco 9877**  
GM

UNIT PACKAGE: 100



**14642**  
(20199675)  
Nylon

Quarter Belt Reveal Moulding Clip  
Width: 7/16"  
Length: 31/32"  
GM 1980-On

UNIT PACKAGE: 50



**10617**  
(8799350)  
Nylon

Door, Quarter Panel & Rear End Moulding Clip  
GM 1970-On

UNIT PACKAGE: 50



**12824**  
(20274997)  
Nylon

Rear Quarter Reveal Moulding Clip  
GM 1980-On

UNIT PACKAGE: 50

# GENERAL MOTORS CLIPS & FASTENERS

## Sec. 20



**17219**  
(21093588)  
Nylon

Roof Drip  
Moulding Clip  
2 Door & 4 Door Models  
GM Saturn 1991-On

UNIT PACKAGE: 25



**20232**  
(10287926)  
Yellow Nylon

Front & Rear Door  
Window Moulding Clip  
Overall Length: 1-9/16"  
Buick Century & Regal  
and Oldsmobile Intrigue 1997 - On

UNIT PACKAGE: 25



**10318**  
(8733059)  
4492962, 9838109)  
Nylon

Body Side & Wheel Opening  
Moulding Clip  
Buick, Chevrolet & Oldsmobile 1968-On

UNIT PACKAGE: 100

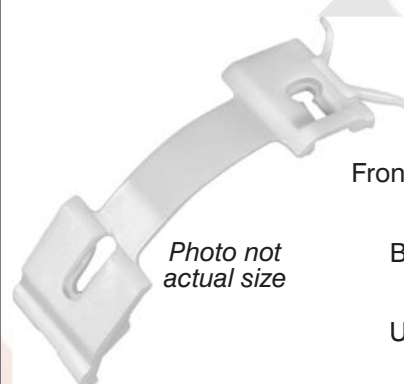

**17979**  
(25552856)  
Nylon

Front & Rear Door Center  
Moulding Clip  
Length: 4-3/8"  
Buick LeSabre Ltd.  
1992-On

*Photo not  
actual size*

UNIT PACKAGE: 5



**14033**  
(20393536)  
Nylon

Front/Side Fender  
Moulding Clip  
GM Truck 1983-On

UNIT PACKAGE: 25

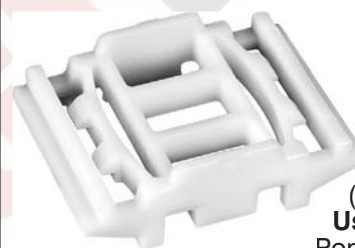

**18417**  
(12519975)  
Nylon

Front & Rear Door  
Lower Finish Panel  
(Lower) Moulding Clip  
**Use with Auveco 18421**  
Pontiac Bonneville 1992-On

UNIT PACKAGE: 15



**13458**  
(20444103)  
Nylon

Door Moulding Clip  
GM 1984-On

UNIT PACKAGE: 15



**20578**  
(GM: 88970495, 88973654;  
Toyota: 76924-52021)  
Black Nylon

Rocker Moulding Retainer  
Head Diameter: 32mm  
Stem Length: 10mm  
Fits into 22mm Hole  
Pontiac Vibe & Toyota Corolla 2003 - On

UNIT PACKAGE: 25



**13828**  
(GM: 1706200)

Quarter Belt Moulding Clip  
Cadillac 1976-On

UNIT PACKAGE: 25



**20263**  
(22599312)  
Black Nylon

Front & Rear Door  
Window Moulding Clip  
Chevrolet Malibu, Oldsmobile  
Achieva & Cutlass 1997 - On

UNIT PACKAGE: 25



**19358**  
(3526573)  
Nylon

Front & Rear Door  
Lower Moulding Clip  
Cadillac DeVille & Seville 1997-92

UNIT PACKAGE: 10

**Sec. 20**

**GENERAL MOTORS CLIPS & FASTENERS**



**18418**  
(16611889)  
Nylon

Front Fender, Door  
& Rear Quarter Panel  
Center Moulding (Lower) Clip  
Pontiac Grand Prix 1991-On

UNIT PACKAGE: 10



**19411**  
(25630331)  
Nylon

Front Door and  
Front & Rear Fender  
Moulding Clip  
Pontiac Bonneville  
1996-On

UNIT PACKAGE: 10



**18428**  
(10167448)  
Nylon

Rear Quarter Center Front  
Moulding Clip  
Excludes Deluxe Extra Trim  
Olds Cutlass 1994-92

UNIT PACKAGE: 25

**18423**  
(25552853)  
Nylon

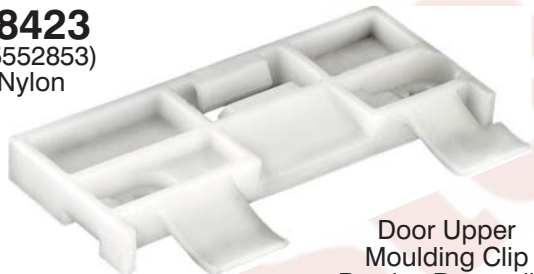

Door Upper  
Moulding Clip  
Pontiac Bonneville  
1992-On

UNIT PACKAGE: 15

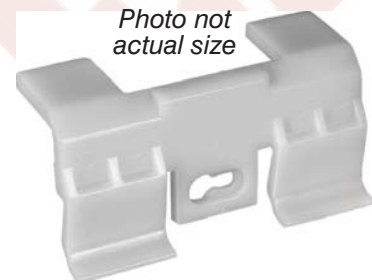

Photo not  
actual size

**19357**  
(10167445)  
Nylon

Rocker Quarter Panel  
Moulding Clip  
Oldsmobile Cutlass  
Supreme 1997-92

UNIT PACKAGE: 15



**19370**  
(16615006)  
Nylon

Rocker Panel  
Moulding Clip  
Oldsmobile Aurora 1995-On

UNIT PACKAGE: 15



**20280**  
(25648693)  
Gray Nylon

Rocker Panel Moulding Clip  
Width: 7/8"  
Length: 2"  
Cadillac DeVille &  
Seville 1998 - On

UNIT PACKAGE: 10



**20318**  
(25722671)  
Gray Nylon

Rocker Panel Clip  
Width: 7/8"  
Length: 2"  
Buick LeSabre, Cadillac DeVille &  
Seville, Oldsmobile Aurora and  
Pontiac Bonneville 2000 - On

UNIT PACKAGE: 10

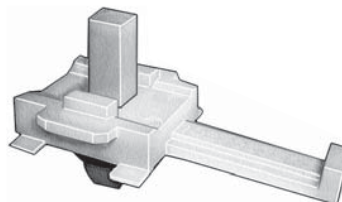

**19390**  
(10270672)  
Nylon

Rear Side Door  
Lower Moulding Clip  
Pontiac Trans Sport,  
Montana 1997-On

UNIT PACKAGE: 10

# GENERAL MOTORS CLIPS & FASTENERS

## Sec. 20



**18390**  
(10082288)  
Black Nylon

Front Door  
Moulding Retainer  
Chevrolet Beretta, Corsica 1987-On

UNIT PACKAGE: 25



**22224**  
(GM: 92139070)  
White Nylon

Pillar Trim Moulding Clip  
Width from Ear to Ear: 9.3mm  
Bottom Width: 10.4mm  
Overall Height: 15.5mm  
Chevrolet Caprice & SS 2011 - On  
Pontiac G8 2009 - 2008

UNIT PACKAGE: 25



**22161**  
(GM: 94748652)  
White Nylon

Quarter Panel & Exterior Trim  
Moulding Clip  
Width from Ear to Ear: 8mm  
Overall Height: 15mm  
Chevrolet Corvette Stingray  
& Z06 2014 - On

UNIT PACKAGE: 25



**22021**  
(Ford: W790225-S900)  
Gray Nylon

Fender Corner &  
Rocker Moulding Clip  
Top Head Size: 16mm x 23mm  
Bottom Head Diameter: 17mm  
Stem Length: 12mm  
Fits into 9mm Hole  
Ford Focus 2012 - On

UNIT PACKAGE: 10



**20408**  
(10287547)  
White Nylon

Door & Rocker Panel Moulding Clip  
Top Head Size: 3.5mm x 8mm  
Bottom Head Size: 8.7mm x 12mm  
Stem Length: 8mm  
Fits into 8mm Hole  
Buick Century, Regal &  
Pontiac Grand Prix 1995 - On

UNIT PACKAGE: 25



**15695**  
(Toyota: 62955-20020; GM: 94848834)  
Nylon

Retainer with Sealer  
Head Diameter: 15mm  
Stem Length: 9mm  
Fits into 8mm Hole  
Toyota Pick-Up Truck, Pontiac Vibe

UNIT PACKAGE: 25



**21316**  
(94530742)  
White Nylon

Fender, Wheel, Side & Bumper  
Moulding Clip with Sealer  
Top Head Size: 11mm x 15mm  
Bottom Head Diameter: 16mm  
Stem Length: 10mm  
Fits into 8mm Hole  
Saturn Vue 2008 - On  
Chevrolet Captiva & Cruze 2011 - On

UNIT PACKAGE: 15



**21158**  
(11569920)  
Green Nylon

Fender Moulding Clip with Sealer  
Top Head Size: 7.5mm x 11mm  
Bottom Head Size: 15mm x 15mm  
Stem Length: 13mm  
Fits into 7mm Hole  
Buick Enclave, Cadillac CTS, Chevrolet  
Traverse & GMC Acadia 2003 - On

UNIT PACKAGE: 10



**21825**  
(GM: 11611375)  
White Nylon

Moulding Clip with Sealer  
Top Head Size: 8mm x 18mm  
Bottom Head Diameter: 15mm  
Stem Length: 13mm  
Fits into 8mm Hole  
Cadillac, Chevrolet & GMC 2014 - 13

UNIT PACKAGE: 15



**22222**  
(GM: 92138865)  
White Nylon

Body Side Moulding Clip  
Top Head Size: 23mm x 28mm  
Bottom Head Diameter: 19mm  
Stem Length: 14mm  
Fits into 9mm Hole  
Chevrolet Caprice & SS 2011 - On  
Pontiac G8 2009 - 2008

UNIT PACKAGE: 15

**Sec. 20**

**GENERAL MOTORS CLIPS & FASTENERS**



**20326**

(25718851)  
Yellow Nylon

Door Trim Moulding Clip  
Head Size: 9/16" x 3/4"  
Stem Length: 3/8"  
Cadillac DeVille & Seville 1998 - On

UNIT PACKAGE: 25



**22276**

(GM: 11547024)  
Red Nylon

Door Sill Plate Moulding Clip  
with Metal Reinforcement & Sealer  
Top Head Size: 17mm x 24mm  
Bottom Head Size: 10mm x 24mm  
Stem Length: 10mm  
Cadillac ELR & XTS 2013 - On  
Chevrolet Camaro & Malibu 2016 - On

UNIT PACKAGE: 10



**22022**

(GM: 24405740)  
Blue Nylon

Windshield Pillar, Interior & Trunk Trim  
Moulding Clip with Metal Reinforcement  
Top Head Size: 17mm x 20mm  
Bottom Head Size: 14mm x 28mm  
Stem Length: 11mm  
Buick Allure, Lacrosse, Regal & Verano, Cadillac XTX,  
Chevrolet Camaro, Caprice, Cruze, Malibu, Sonic &  
Volt, Pontiac G8 and Saturn Astra 2008 - On

UNIT PACKAGE: 15

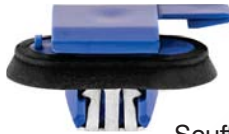

**22268**

(GM: 11611367)  
Blue Nylon

Scuff Plate & Trim Panel Moulding Clip  
with Sealer & Metal Reinforcement  
Top Head Size: 17mm x 24mm  
Bottom Head Size: 10mm x 24mm  
Stem Length: 10mm  
Overall Height: 16mm  
Buick Verano, Cadillac ATS, CTS & XTS,  
Chevrolet Camaro, Impala, Malibu & Volt 2011 - On

UNIT PACKAGE: 10



**22024**

(GM: 24405739)  
Black Nylon

Windshield Pillar & Interior Trim  
Moulding Clip with Metal Reinforcement  
Top Head Size: 17mm x 20mm  
Bottom Head Size: 14mm x 28mm  
Stem Length: 12mm  
Buick Allure, Encore, Lacrosse, Regal & Verano,  
Cadillac XTS, Chevrolet Camaro, Caprice,  
Cruze, Malibu & Sonic 2010 - On

UNIT PACKAGE: 15



**19757**

(10431524)  
Black Nylon

Rocker Panel Moulding Clip  
Head Size: 11/16" x 1-5/16"  
Stem Length: 9/16"  
Fits into 5/16" Hole  
Chevrolet Impala, Lumina  
& Monte Carlo 2000 - On

UNIT PACKAGE: 15



**22080**

(GM: 11611623)  
Blue Nylon

Interior Trim & Windshield Pillar  
Moulding Clip with Metal Reinforcement  
Top Head Size: 17mm x 24mm  
Bottom Head Size: 14mm x 28mm  
Stem Length: 10mm  
Cadillac ATS & Escalade, Chevrolet Corvette, Impala &  
Malibu and GMC Sierra & Yukon 2013 - On

UNIT PACKAGE: 10



**19800**

(10352803, 10437565)  
Black Nylon

Rocker Panel Moulding Clip  
Head Size: 15/32" x 1-5/16"  
Stem Length: 9/16"  
Fits into 5/16" Hole  
Chevrolet Impala, Lumina &  
Monte Carlo 2000 - On

UNIT PACKAGE: 10



**22167**

(GM: 11547026)  
Red Nylon

Interior Trim & Windshield Garnish  
Moulding Clip with Metal Reinforcement  
Top Head Size: 17mm x 24mm  
Bottom Head Size: 14mm x 28mm  
Stem Length: 10mm  
Cadillac ATS & CTS, Chevrolet Impala  
and GMC Yukon 2013 - On

UNIT PACKAGE: 10



**20810**

(10431523)  
Tan Nylon

Rocker Panel Moulding Clip  
Head Size: 11/16" x 1-5/16"  
Stem Length: 9/16"  
Fits into 5/16" Hole  
Chevrolet Impala, Lumina  
& Monte Carlo 2000 - On

UNIT PACKAGE: 15

# GENERAL MOTORS CLIPS & FASTENERS

## Sec. 20



**20811**  
(10431526)  
Red Nylon

Rocker Panel Moulding Clip  
Head Size: 11/16" x 1-5/16"  
Stem Length: 9/16"  
Fits into 5/16" Hole  
Chevrolet Impala, Lumina  
& Monte Carlo 2000 - On

UNIT PACKAGE: 15



**20974**  
(10352804)  
Maroon Nylon

Rocker Panel Moulding Clip  
Head Size: 15/32" x 1-9/32"  
Stem Length: 11/16"  
Fits into 5/16" Hole  
Chevrolet Impala, Lumina  
& Monte Carlo 2000 - On

UNIT PACKAGE: 10



**20775**  
(10352809)  
White Nylon

Rocker Panel Moulding Clip  
Head Size: 11/16" x 1-5/16"  
Stem Length: 11/16"  
Fits into 5/16" Hole  
Chevrolet Impala, Lumina &  
Monte Carlo 2000 - On

UNIT PACKAGE: 15



**20976**  
(25742293)  
Blue Nylon

Rocker Panel Moulding Clip  
Top Head Size: 9/16" x 25/32"  
Bottom Head Size: 5/8" x 25/32"  
Stem Length: 9/16"  
Fits into 3/8" Hole  
Cadillac DeVille & Seville 2000 - On

UNIT PACKAGE: 15



**20809**  
(10352797)  
Gray Nylon

Rocker Panel Moulding Clip  
Head Size: 11/16" x 1-5/16"  
Stem Length: 11/16"  
Fits into 5/16" Hole  
Chevrolet Impala, Lumina  
& Monte Carlo 2000 - On

UNIT PACKAGE: 15



**20972**  
(11589176)  
White Nylon

Rocker Panel Moulding Clip  
Top Head Size: 3/4" x 1-1/32"  
Bottom Head Size: 19/32" x 1-1/32"  
Stem Length: 9/16"  
Fits into 3/8" Hole  
Chevrolet Malibu 2004 - On

UNIT PACKAGE: 15



**20808**  
(10352799)  
Black Nylon

Rocker Panel Moulding Clip  
Head Size: 11/16" x 1-5/16"  
Stem Length: 11/16"  
Fits into 5/16" Hole  
Chevrolet Impala, Lumina  
& Monte Carlo 2000 - On

UNIT PACKAGE: 15



**20865**  
(15221959)  
Gray Nylon

Rocker Panel Moulding Clip  
Width: 9/16"  
Length: 1-1/8"  
Stem Length: 9/16"  
Fits into 1/2" Hole  
Chevrolet Cobalt & HHR 2005 - On

UNIT PACKAGE: 15



**20973**  
(10352798)  
Tan Nylon

Rocker Panel Moulding Clip  
Head Size: 11/16" x 1-5/16"  
Stem Length: 11/16"  
Fits into 5/16" Hole  
Chevrolet Impala, Lumina  
& Monte Carlo 2000 - On

UNIT PACKAGE: 15



**19820**  
(22603384)  
White Nylon

Rocker Panel Moulding Clip  
Head Size: 3/4" x 1-3/16"  
Stem Length: 19/32"  
Fits into 7/16" Hole  
Oldsmobile Alero  
& Pontiac Grand Am 1999 - On

UNIT PACKAGE: 15

**Sec. 20**

**GENERAL MOTORS CLIPS & FASTENERS**



**21128**  
(11562563)  
White Nylon

Rocker Moulding Clip  
Upper Head Size: 12mm x 20mm  
Bottom Head Size: 12mm x 32mm  
Stem Length: 15mm  
Fits into 10mm Hole  
Chevrolet Malibu 2008 - On

UNIT PACKAGE: 15



**20328**  
(10443956)  
White Nylon

Rocker Panel Moulding Clip  
Top Head Size: 9/16" x 13/16"  
Bottom Head Size: 13/16" x 13/16"  
Stem Length: 9/16"  
Fits into 7/16" Hole  
Chevrolet Impala, Lumina, Monte Carlo  
and C & K Trucks 2000 - On

UNIT PACKAGE: 15



**20607**  
(10323057)  
White Nylon

Rocker Moulding Clip  
Top Head Size: 12mm x 20mm  
Bottom Head Size: 12mm x 24mm  
Stem Length: 14mm  
Fits into 9mm Hole  
Pontiac Grand Prix 2004 - On

UNIT PACKAGE: 15



**19822**  
(25693852)  
Gray Nylon

Rocker Panel Moulding Clip  
Top Head: 9/16" x 3/4"  
Bottom Head: 5/8" x 3/4"  
Stem Length: 9/16"  
Fits into 7/16" Hole  
Buick LeSabre; Cadillac Concours,  
DeVille, Eldorado & Seville; Chevrolet  
Impala, Lumina & Monte Carlo;  
Oldsmobile Aurora and  
Pontiac Bonneville 1995 - On

UNIT PACKAGE: 25



**20952**  
(15236894)  
White Nylon

Rocker Panel Moulding Clip  
Top Head Size: 9/16" x 23/32"  
Overall Height: 5/8"  
Stem Length: 7/16"  
Fits into 3/8" Hole  
Buick Lucerne and  
Cadillac CTS & STS 2003 - On

UNIT PACKAGE: 15



**20885**  
(15288146, 15893516)  
Gray Nylon

Windshield Pillar  
Moulding Clip with Sealer  
Top Head Size: 12mm x 20mm  
Bottom Head Size: 14mm x 20mm  
Stem Length: 15mm  
Fits into 9mm Hole  
Chevrolet Equinox &  
Pontiac Torrent 2005 - On

UNIT PACKAGE: 15



**20377**  
(11518357)  
White Nylon

Rocker Panel Moulding Clip with Sealer  
Top Head Size: 9/16" x 13/16"  
Bottom Head Size: 13/16" x 13/16"  
Stem Length: 9/16"  
Fits into 7/16" Hole  
Chevrolet Avalanche 2002 - On

UNIT PACKAGE: 15



**22258**  
(GM: 11547211)  
White Nylon

Rocker Moulding Clip  
with Sealer  
Top Head Size: 12mm x 20mm  
Bottom Head Size: 12mm x 20mm  
Stem Length: 16mm  
Fits into 9mm Hole  
Cadillac CT6 2016 - On

UNIT PACKAGE: 10



**20417**  
(91176726)  
White Nylon

Side Door, Wheel Opening &  
Rocker Panel Moulding Clip with Sealer  
Top Head Size: 15/32" x 25/32"  
Bottom Head Size: 9/16" x 25/32"  
Stem Length: 7/16"  
Fits into 7/16" Hole  
Geo Tracker 2001 - On

UNIT PACKAGE: 15





**21793**  
(GM: 11610495)  
White Nylon

Rocker Panel  
Moulding Clip with Sealer  
Top Head Size: 12mm x 20mm  
Bottom Head Size: 12mm x 24mm  
Stem Length: 14mm  
Fits into 9mm Hole  
Chevrolet Camaro 2010 and  
Pontiac G6 & Grand Prix 2004 - On

UNIT PACKAGE: 15



**22036**  
(GM: 11546635, 11612122)  
Yellow Nylon

Rocker Moulding Clip  
with Sealer  
Top Head Size: 9mm x 20mm  
Bottom Head Size: 14mm x 20mm  
Stem Length: 14mm  
Fits into 9mm Hole  
Cadillac ATS & CTS 2013 - On

UNIT PACKAGE: 10



**20774**  
(25724529)  
White Nylon

Rocker Moulding &  
Grille Moulding Clip  
Top Head Size: 9/16" x 13/16"  
Bottom Head Size: 5/8" x 13/16"  
Stem Length: 9/16"  
Fits into 3/8" Hole  
Buick LeSabre & Rainier; Cadillac  
Concours, CTS, DeVille, Eldorado,  
Escalade, Seville, SRX & STS; Chevrolet  
Avalanche, Impala, Lumina, Monte Carlo,  
SSR, Vans & Trucks; Oldsmobile Aurora &  
Bravada and Pontiac Bonneville 1992 - On

UNIT PACKAGE: 15



**20756**  
(5480852)  
Yellow Nylon

Rocker Panel  
Moulding Clip with Sealer  
Top Head Size: 9/16" x 25/32"  
Bottom Head Size: 5/8" x 13/16"  
Stem Length: 9/16"  
Chevrolet Equinox 2005 - On

UNIT PACKAGE: 10



**20934**  
(15127746)  
White Nylon

Body Side Moulding Clip  
Top Head Size: 12mm x 20mm  
Bottom Head Size: 12mm x 20mm  
Stem Length: 11mm  
Fits into 9mm Hole  
Buick Terraza, Chevrolet Uplander, GMC Acadia,  
Pontiac Montana SV6 and Saturn Relay 2005 - On

UNIT PACKAGE: 15



**21242**  
(11562250)  
White Nylon

Rocker Panel Moulding Clip with Sealer  
Top Head Size: 12mm x 20mm  
Bottom Head Size: 12mm x 20mm  
Stem Length: 11mm  
Fits into 9mm Hole  
GMC Acadia 2007 - On

UNIT PACKAGE: 15



**21374**  
(GM: 11571175;  
Chrysler: 68172491AA)  
Gray Nylon

Rocker Moulding Clip with Sealer  
Top Head Size: 12mm x 20mm  
Bottom Head Size: 12mm x 20mm  
Stem Length: 11mm  
Fits into 9mm Hole  
Chevrolet Traverse 2010 - On  
Chrysler 200 2015 - On  
Jeep Grand Cherokee 2015 - 2012

UNIT PACKAGE: 15



**21156**  
(11570512)  
Yellow Nylon

Side Window Reveal  
Moulding Clip with Sealer  
Width: 12.5mm  
Length: 28mm  
Overall Height: 13mm  
Fits into 6mm Hole  
Buick Lucerne 2006 - On

UNIT PACKAGE: 10



**21129**  
(11569918)  
White Nylon

Roof Rail Moulding Clip with Sealer  
Top Head Size: 13mm x 30mm  
Stem Length: 13mm  
Fits into 7mm Hole  
Buick Enclave &  
GMC Acadia 2007 - On

UNIT PACKAGE: 15

**Sec. 20**

**GENERAL MOTORS CLIPS & FASTENERS**



**20481**  
(10423553)  
Green Nylon

Side Moulding, Fender & Rocker Panel Moulding Clip  
Top Head Size: 1/2" x 13/16"  
Bottom Head Size: 19/32" x 13/16"  
Stem Length: 9/16"  
Fits into 7/16" Hole  
Pontiac Aztek and GM C & K Trucks 2001 - On

UNIT PACKAGE: 15



**20521**  
(10242285, 10308019, 10297369)  
Black Nylon with Sealer

Rocker Panel Moulding Clip  
Top Head Size: 15/32" x 25/32"  
Bottom Head Size: 5/8" x 25/32"  
Stem Length: 9/16"  
Fits into 7/16" Hole  
Pontiac Aztek, Montana & Trans Sport 1997 - On

UNIT PACKAGE: 15



**20353**  
(10442914)  
White Nylon

Rocker Panel Moulding Clip  
Top Head Size: 1/2" x 9/16"  
Bottom Head Size: 9/16" x 5/8"  
Stem Length: 9/16"  
Fits into 7/16" Hole  
Buick Rendezvous 2002 - On

UNIT PACKAGE: 15



**21504**  
(GM: 10445899)  
Black Nylon

Door Moulding Clip  
Top Head Size: 14mm x 20mm  
Bottom Head Size: 15.5mm x 20mm  
Stem Length: 14mm  
Fits into 9mm Hole  
GM SUV's 1997 - On

UNIT PACKAGE: 15



**22027**  
(GM: 11570847)  
Yellow Nylon

Lower Door Moulding Clip with Sealer  
Top Head Size: 12.5mm x 20mm  
Bottom Head Diameter: 18mm  
Stem Length: 11mm  
Fits into 9mm Hole  
Cadillac SRX 2010 - On

UNIT PACKAGE: 10



**19381**  
(10297368)  
White Nylon

Rear Wheel Opening Moulding Clip  
Top Head Size: 15/32" x 25/32"  
Bottom Head Size: 1/2" x 25/32"  
Stem Length: 9/16"  
Fits into 7/16" Hole  
Pontiac Trans Sport, Montana with Short Wheel Base 1997 - On

UNIT PACKAGE: 10



**19379**  
(10297371)  
Yellow Nylon

Rear Wheel Opening Moulding Clip  
Top Head Size: 19/32" x 25/32"  
Stem Length: 9/16"  
Fits into 7/16" Hole  
Pontiac Trans Sport, Montana with Long Wheel Base 1997 - On

UNIT PACKAGE: 15



**20825**  
(10297370)  
Brown Nylon

Moulding Clip with Sealer  
Top Head Size: 12mm x 20mm  
Bottom Head Size: 15mm x 20mm  
Stem Length: 14mm  
Fits into 11mm Hole  
Chevrolet Venture, Oldsmobile Silhouette, Pontiac Trans Sport APV & Montana and Hummer 1997 - On

UNIT PACKAGE: 15



**22029**  
(GM: 11547210)  
Green Nylon

Moulding Clip with Sealer  
Top Head Size: 12mm x 20mm  
Bottom Head Size: 12mm x 20mm  
Stem Length: 10mm  
Fits into 9mm Hole  
Cadillac XTS & Chevrolet Impala 2014 - 2013

UNIT PACKAGE: 10



**20935**  
(15116576, 15282120)  
Green Nylon

Body Side Moulding Clip  
Head Size: 16mm x 38mm  
Stem Length: 15mm  
Fits into 10mm Hole  
Buick Terraza, Cadillac C & K Truck, Chevrolet C, K Truck & Uplander, GMC Arcadia, C & K Truck, Pontiac Montana SV6 and Saturn Relay 2005 - On

UNIT PACKAGE: 15

# GENERAL MOTORS CLIPS & FASTENERS

## Sec. 20



### 21036

(11518988)  
White Nylon

Fender, Spoiler & Roof Rack  
Moulding Clip with Sealer  
Top Head: 12mm x 21mm  
Bottom Head: 12mm x 20mm  
Stem Length: 15mm  
Fits into 9mm Hole

Buick Enclave, Chevrolet SSR,  
GMC Acadia, Hummer H3, S & T Trucks 2002 - On

UNIT PACKAGE: 15



### 21667

(11609923)  
Gray Nylon

Moulding Clip with Sealer  
Top Head Size: 12mm x 20mm  
Bottom Head Size: 12mm x 24mm  
Stem Length: 16mm

Chevrolet Camaro and Pontiac G6 2005 - On

UNIT PACKAGE: 15



### 21681

(GM: 25796285)  
White Nylon

Moulding Clip with Sealer  
Top Head Size: 6.5mm x 15mm  
Bottom Head Size: 13mm x 26mm  
Stem Length: 8mm  
Fits into 7mm Hole  
Cadillac CTS & Chevrolet Silverado  
2007 - On

UNIT PACKAGE: 15



### 21013

(Not Available from O.E.M.)  
Yellow Nylon

Rocker Panel Moulding Clip  
Top Head Size: 15/32" x 13/16"  
Bottom Head Size: 15/32" x 25/32"  
Stem Length: 9/16"  
Fits into 3/8" Hole  
Hummer H3 2005 - On

UNIT PACKAGE: 15



### 21370

(GM: 25922739, 11570846)  
Green Nylon

Rocker Moulding Clip with Sealer  
Top Head Size: 12mm x 29mm  
Bottom Head Size: 12mm x 20mm  
Stem Length: 10mm  
Fits into 9mm Hole

Buick Enclave, Cadillac SRX, Chevrolet Tahoe,  
Traverse & GMC Acadia, Yukon 2009 - On

UNIT PACKAGE: 25



### 21200

(11588818, 11561329)  
Black Nylon

Front Bumper and  
Rocker Moulding Clip  
Top Head Size: 18mm x 26mm  
Bottom Head Size: 14mm x 20mm  
Stem Length: 15mm  
Fits into 10mm Hole  
Cadillac STS and Corvette 2005 - On

UNIT PACKAGE: 10



### 22225

(GM: 92138808)  
Black Nylon

Rocker Moulding Clip  
Top Head Size: 15mm x 21mm  
Middle Head Size: 15mm x 21mm  
Bottom Head Size: 19.3mm x 25.5mm  
Stem Length: 14mm  
Fits into 9mm Hole

Chevrolet Caprice & SS 2011 - On  
Pontiac G8 2009 - 2008

UNIT PACKAGE: 25



### 20951

(15236893)  
Black Nylon

Rocker Panel  
Moulding Clip  
Top Head Size: 3/4" x 1-9/16"  
Overall Height: 11/16"  
Stem Length: 7/16"  
Fits into 3/8" Hole  
Buick Lucerne 2006 - On

UNIT PACKAGE: 15



### 20868

(11589182)  
Black Nylon

Rocker Panel Moulding  
Clip with Sealer  
Head Size: 11/16" x 2-3/16"  
Stem Length: 11/16"  
Fits into 5/8" Hole  
Hummer 2006 - On

UNIT PACKAGE: 10



### 20884

(11561491, 15872008)  
Black Nylon

Rocker Panel Moulding Clip  
with Sealer  
Top Head: 20mm x 30mm  
Overall Length: 28mm  
Fits into 17mm Hole

Chevrolet Equinox & Pontiac Torrent 2005 - On

UNIT PACKAGE: 10

**Sec. 20**

**GENERAL MOTORS CLIPS & FASTENERS**



**21503**  
(GM: 25744385)  
Green Nylon

Rocker Moulding Clip  
Head Size: 22mm x 46mm  
Stem Length: 17mm  
Fits into 10mm Hole  
Cadillac 1998 - On

UNIT PACKAGE: 15



**20464**  
(10270517)  
White Nylon

Rocker Panel & Fender Flare  
Moulding Clip  
Overall Length: 41mm  
Stem Length: 13mm  
Fits into 12mm Hole  
Pontiac Trans Sport & Montana 1997 - On

UNIT PACKAGE: 5



**22226**  
(GM: 92138807)  
White Nylon

Rocker Moulding Clip  
Width: 31.5mm  
Length: 45mm  
Bottom Head Diameter: 25mm  
Stem Length: 15mm  
Fits into 9mm Hole  
Chevrolet Caprice & SS 2011 - On  
Pontiac G8 2009 - 2008

UNIT PACKAGE: 25



**21827**  
(GM: 11611435)  
White Nylon

Moulding Clip  
with Sealer  
Top Head Size: 22mm x 45mm  
Bottom Head Size: 25mm x 37mm  
Stem Length: 15mm  
Fits into 10mm Hole  
Cadillac, Chevrolet & GMC 2014 - 13

UNIT PACKAGE: 10



**21177**  
(10363352)  
Black Nylon

Rocker, Pillar and  
Floor Moulding Clip  
Top Head Size: 18mm x 38mm  
Bottom Head Size: 22mm x 40mm  
Stem Length: 33mm  
Fits into 11mm Hole  
Saturn Aura 2007 - On

UNIT PACKAGE: 15



**21161**  
(GM: 11569697)  
Green Nylon

Side Window (Rear) Reveal  
Moulding Clip with Sealer  
Flange Size: 10mm x 17mm  
Stem Length: 20mm  
Overall Length: 29mm  
Fits into 8mm Hole  
Buick Lucerne 2006 - On

UNIT PACKAGE: 5



**19821**  
(10431761)  
Gray Nylon

Rocker Panel Moulding Clip  
Top Head Size: 11/16" x 1-1/2"  
Bottom Head Size: 7/8 x 1-9/16"  
Stem Length: 1-1/4"  
Fits into 7/16" Hole  
Chevrolet Impala, Lumina &  
Monte Carlo 2000 - On

UNIT PACKAGE: 15



**21157**  
(11610522, 10383817)  
White Nylon

Side Window (Rear) Reveal  
Moulding Clip with Sealer  
Top Head Size: 6mm x 11mm  
Bottom Head Size: 10mm x 17mm  
Stem Length: 20mm  
Fits into 8mm  
Buick Lucerne 2006 - On

UNIT PACKAGE: 10

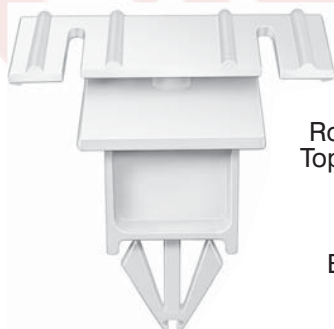

**20950**  
(10384814)  
White Nylon

Rocker Panel Moulding Clip  
Top Head Size: 3/4" x 1-9/16"  
Overall Height: 1-7/16"  
Stem Length: 21/32"  
Fits into 7/16" Hole  
Buick Lucerne 2006 - On

UNIT PACKAGE: 15



**22037**  
(GM: 15864780; 11569921)  
Yellow Nylon

Rocker Moulding Clip with Sealer  
Top Head Size: 9.5mm x 20mm  
Bottom Head Size: 14mm x 20mm  
Stem Length: 20mm  
Fits into 9mm Hole  
Cadillac ATS & CTS 2013 - On

UNIT PACKAGE: 10

# GENERAL MOTORS CLIPS & FASTENERS

## Sec. 20



**21335**  
(25775903)  
Green Nylon

Rocker Moulding Clip with Sealer  
Top Head Size: 12mm x 16mm  
Bottom Head Size: 12mm x 20mm  
Stem Length: 24mm  
Fits into 9mm Hole  
Buick Enclave, Chevrolet Traverse,  
GMC Acadia & Saturn Outlook 2007 - On

UNIT PACKAGE: 10



**21375**  
(25774893)  
Yellow Nylon

Door Moulding Clip  
Top Head Size: 12mm x 16mm  
Bottom Head Size: 12mm x 20mm  
Stem Length: 24mm  
Fits into 9mm Hole  
Chevrolet Traverse 2010 - On

UNIT PACKAGE: 15



**20891**  
(11589244, 11569973)  
Yellow Nylon

Rocker Panel  
Moulding Clip with Sealer  
Top Head Size: 15/32" x 27/32"  
Bottom Head Size: 15/32" x 25/32"  
Stem Length: 1-3/8"  
Fits into 7/16" Hole  
Chevrolet Equinox, Pontiac Torrent  
and Trucks 2005 - On

UNIT PACKAGE: 10



**21739**  
(GM: 11611626)  
White Nylon

Tailgate Cover Clip  
Top Head Size: 12.5mm x 23mm  
Bottom Head Size: 12.5mm x 23mm  
Stem Length: 11mm  
Fits into 9mm Hole  
Cadillac Escalade; Chevrolet Avalanche,  
Silverado, Suburban & Tahoe and GMC  
Sierra 2007 - On

UNIT PACKAGE: 25



**11118**  
(9617200)  
Nylon

Roof, Inner Side Front, Rear &  
Panel Headlining Clip  
GM 1973-On

UNIT PACKAGE: 10

**11119**

Same as 11118 except for unit package quantity

UNIT PACKAGE: 100



**18398**  
(20058837)  
Nylon

Windshield Upper Garnish  
Moulding Clip  
GM A & G Models 1988-78

UNIT PACKAGE: 10



**17666**  
(20632190)  
Nylon

Garnish Moulding Clip  
Back Window Upper &  
Side Moulding Garnish  
Buick LeSabre, Cadillac  
Fleetwood Brougham,  
Chevrolet Caprice & Impala,  
Olds Delta 88 & 98, Pontiac  
Bonneville & Parisienne 1988-80

UNIT PACKAGE: 10

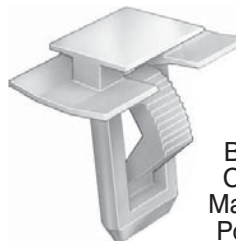

**16865**  
(20462090)  
Nylon

Garnish Moulding Clip  
Buick Century & Regal, Chevrolet  
Camaro, Celebrity, Monte Carlo &  
Malibu, Oldsmobile Cutlass & Ciera,  
Pontiac Firebird Grand Prix & 6000  
1978-On

UNIT PACKAGE: 25



**9477**  
(4490167)  
Nylon

Tailgate Belt  
Moulding Fastener  
Chevrolet El Camino

UNIT PACKAGE: 50

**Sec. 20**

**GENERAL MOTORS CLIPS & FASTENERS**



**17233**  
(9662548)  
Nylon

Headlining Wire Retainer Clip  
Also Panel to Rear Bumper Filler Clip  
GM 1990 - 73

UNIT PACKAGE: 50



**14727**  
(GM: 94221150;  
Isuzu: 8942211500;  
Nissan: 63844-D0100)  
Black Nylon

Push-Type Retainer  
Head Size: 14mm x 22mm  
Stem Length: 9mm  
Fits into 7mm Hole  
Geo Storm 1990 - On

UNIT PACKAGE: 25



**9965**  
(3944866, 1244839)

Universal Moulding Fastener  
GM

UNIT PACKAGE: 25



**20892**  
(12337831)  
Black Nylon

Front Bumper  
Push-Type Retainer  
Head Size: 14mm x 26mm  
Stem Length: 14mm  
Fits into 8mm Hole  
Pontiac G6 2005 - On

UNIT PACKAGE: 50



**2943**  
(4759145, 4761842, 4779348)

Front and Rear Fender and  
Door Peak Moulding Fastener  
GM

UNIT PACKAGE: 15



**14008**  
(14032200)  
Black Nylon

Grille Attachment Retainer  
Head Size: 3/4" x 19/32"  
Stem Length: 19/32"  
Fits into 5/16" Hole  
GM 1981-On

UNIT PACKAGE: 25



**19602**

Chevrolet Grille Bolt Kit  
For installing and attaching Grille on Chevrolet Cars  
Consists of: 50 pcs. 10-24 x 1/2" Machine Screws  
50 pcs. 10-24 Keps Nuts

UNIT PACKAGE: 50 Sets



**22041**  
(GM: 92139147)  
Black Nylon

Front & Rear Bumper Fascia  
Push-Type Retainer  
Head Size: 14mm x 21mm  
Stem Length: 16mm  
Fits into 8mm Hole  
Chevrolet Caprice and  
Pontiac G8 & GTO 2011 - 04

UNIT PACKAGE: 25



**14953**  
(GM: 15679091; Ford: N803494S)  
Black Nylon

Fascia, Trim & Grille Retainer  
Head Size: 15/32" x 15/32"  
Stem Length: 21/32"  
Fits into 1/4" Square Hole or Slot  
GM 1994 - On  
Ford 1985 - On

UNIT PACKAGE: 25

# GENERAL MOTORS CLIPS & FASTENERS

## Sec. 20



### 14001

(14039420)  
Black Nylon

Push-Type Retainer  
Head Diameter: 21/32"  
Stem Length: 19/32"  
Fits into 5/16" Hole  
GM (Including Saturn)

UNIT PACKAGE: 25



### 14697

(GM: 94198687;  
Honda: 90657-SA6-0030;  
Mazda: N304-13-356-A)  
Black Nylon

Push-Type Retainer  
Head Diameter: 14mm  
Stem Length: 11mm  
Fits into 7mm Hole

UNIT PACKAGE: 25



### 19726

(94858343)  
Black Nylon

Door Trim Panel Push-Type Retainer  
Head Diameter: 14mm  
Stem Length: 8mm (Excluding the Pin)  
Fits into 6mm Hole  
Geo Prizm 1998 - On

UNIT PACKAGE: 15



### 19645

(94858864)  
Nylon

Door Trim Panel  
Push-Type Retainer  
Head Diameter: 14mm  
Stem Length: 8mm (Excluding the Pin)  
Fits into 6mm Hole  
Geo Prizm 1998 - On

UNIT PACKAGE: 15

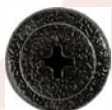

### 14260

(Toyota: 90467-06017;  
Mazda: 9926-50-625;  
GM: 20426301)  
Black Nylon

Push-Type Retainer  
Head Diameter: 15mm  
Stem Length: 12mm  
Fits into 7mm Hole

UNIT PACKAGE: 15



### 19243

(GM: 30008324; Suzuki: 09409-07325)  
Black Nylon

Push-Type Retainer  
Head Diameter: 16mm  
Stem Length: 10mm (Excluding the Pin)  
Fits into 9mm Hole  
Front & Rear Bumper Fascia  
Geo Metro 1989-On  
Radiator Grille  
Suzuki Esteem 1995-On

UNIT PACKAGE: 15



### 13457

(20451119)  
Black Nylon

Front Compartment Spare Tire Retainer  
Head Diameter: 43/64"  
Stem Length: 23/32"  
Fits into 5/16" Hole  
GM

UNIT PACKAGE: 10



### 20577

(GM: 88970494, 88973676;  
Toyota: 90467-07168)  
Black Nylon

Rocker Panel & Garnish  
Moulding Push-Type Retainer  
Head Diameter: 20mm  
Stem Length: 8mm  
Fits into 7mm Hole  
Pontiac Vibe 2003 - On  
Lexus & Toyota 2000 - On

UNIT PACKAGE: 15



### 19140

(Acura: 90505-SL0-003;  
GM: 94852368;  
Mitsubishi: MB888869;  
Toyota: 90467-08155)  
Black Nylon

Push-Type Retainer  
Head Diameter: 20mm  
Stem Length: 21mm  
Fits into 8mm Hole

Acura, Dodge Avenger, Eagle Talon, Geo Prizm  
Mitsubishi Eclipse & Galant and Toyota 1993-On

UNIT PACKAGE: 5



### 19242

(15672149)  
Black Nylon

Air Inlet Grille Panel Push-Type Retainer  
Head Diameter: 13/32"  
Stem Length: 11/16"  
Fits into 7/32" Hole

GM Jimmy, Blazer, S-10 & Bravada 1994-On

UNIT PACKAGE: 25

**Sec. 20**

**GENERAL MOTORS CLIPS & FASTENERS**



**17214**

(GM: 10089262, 21042098;  
Chry: 55075139)  
Black Nylon

Push-Type Retainer  
Head Diameter: 11mm (7/16")  
Stem Length: 18mm (11/16")  
Fits into 6mm (15/64") Hole

GM & Saturn 4 Door & Station Wagon 1987-On

UNIT PACKAGE: 25

**14987**

Same as 17214 except for unit package quantity

UNIT PACKAGE: 50



**14990**

(22538102)  
Black Nylon

Push-Type Retainer  
Head Diameter: 7/16"  
Stem Length: 15/32"  
Fits into 15/64" Hole  
GM 1987 - On

UNIT PACKAGE: 50



**19788**

(10246149; 22657634)  
Black Nylon

Rocker Panel Push-Type Retainer  
Head Diameter: 11mm  
Stem Length: 20mm  
Fits into 6mm Hole

Achieva, Cutlass, Grand Am & Malibu 1999 - On

UNIT PACKAGE: 25



**19787**

(22657634)  
Black Nylon

Fender & Rocker Panel  
Push-Type Retainer  
Head Diameter: 12mm  
Stem Length: 17mm  
Fits into 6mm Hole

Achieva, Cutlass, Grand Am & Malibu 1999 - On

UNIT PACKAGE: 25



**14995**

(GM: 10195515, Ford: N805026S;  
Chry: 4696488, 6503163)  
Black Nylon

Push-Type Retainer  
Head Diameter: 1/2"  
Stem Length: 1-13/64"  
Fits into 9/32" Hole

GM, Ford & Chrysler 1987 - On

UNIT PACKAGE: 25



**16859**

(Nissan: 66860-01W01;  
GM: 94051993)  
Black Nylon

Cowl Panel to Reinforcement  
Plate & Engine Splash  
Shield Retainer

Head Diameter: 14mm (9/16")  
Stem Length: 16mm (5/8")  
Fits into 6mm (1/4") Hole

Nissan 1980-On  
Geo Storm 1990-On

UNIT PACKAGE: 25



**20943**

(15014352)  
Black Nylon

Cowl Vent  
Push-Type Retainer  
Head Diameter: 14mm  
Stem Length: 23mm  
Fits into 7mm Hole  
Buick Lucerne 2006 - On

UNIT PACKAGE: 15



**21112**

(94530438)  
Black Nylon

Fender Liner  
Push-Type Retainer  
Head Diameter: 15mm  
Stem Length: 14mm  
Fits into 6mm Hole  
Chevrolet Aveo 2004 - On

UNIT PACKAGE: 25



**14997**

(10053182)  
Black Nylon

Push-Type Retainer  
Head Diameter: 19/32"  
Stem Length: 13/16"  
Fits into 5/16" Hole  
GM 1987 - On

UNIT PACKAGE: 25



# GENERAL MOTORS CLIPS & FASTENERS

## Sec. 20



### 14991

(GM: 10139822; 25680782;  
Ford: N808147S)  
Black Nylon

Push-Type Retainer  
Head Diameter: 11/16"  
Stem Length: 11/16"  
Fits into 1/4" Hole  
GM & Ford 1987 - On

UNIT PACKAGE: 25



### 20265

(25663903)  
Black Nylon

Radiator Support Sight Shield  
Push-Type Retainer  
Head Diameter: 1"  
Stem Length: 1"  
Fits into 1/4" Hole  
Cadillac DeVille & Seville 1998 - On

UNIT PACKAGE: 10



### 14753

(GM: 15773445, 20452072, 20664092;  
Ford: N804570S; Chry: 4638136)  
Black Nylon

Radiator Shroud & Trim Retainer  
Head Diameter: 11/16"  
Stem Length: 7/8"  
Fits into 1/4" Hole  
GM 1982-On  
Ford 1986-On  
Chrysler 1998 - On

UNIT PACKAGE: 25



### 17227

(21077405)  
Black Nylon

Door Handle to Door Hardware  
Attachment Push-Type Retainer  
Head Diameter: 7mm  
Stem Length: 10mm  
Fits into 5mm Hole  
2 Door & 4 Door Models GM Saturn 1991-On

UNIT PACKAGE: 25



### 14993

(22538004)  
Black Nylon

Push-Type Retainer  
Head Diameter: 11/16"  
Stem Length: 7/8"  
Fits into 1/4" Hole  
GM 1987 - On

UNIT PACKAGE: 25



### 17383

(GM: 94847334, 96057847;  
Toyota: 90467-07066;  
Suzuki: 09409-07313)  
Black Nylon

Radiator Grille & Trim Panel  
Push-Type Retainer  
Head Diameter: 11mm  
Stem Length: 14mm (Excluding the Pin)  
Fits into 7mm Hole  
Geo Tracker & Prizm 1992 - 89

UNIT PACKAGE: 10



### 16835

(GM: 10140480; Chry: 6502625)  
Black Nylon

Rear Bumper Fascia Retainer  
Head Diameter: 21mm (27/32")  
Shoulder Length: 3mm (1/8")  
Stem Length: 25mm (1")  
Fits into 12mm (1/2") Hole  
APV Vans 1990-On

UNIT PACKAGE: 25



### 11854

(14005089)  
Natural Nylon

Air Conditioning Vent &  
General Purpose Push-Type Retainer  
Head Diameter: 7/16"  
Stem Length: 9/32"  
Fits into 3/16" Hole  
GM 1979 - On

UNIT PACKAGE: 25



### 14998

(15672330, 15956470)  
Black Nylon

Push-Type Retainer  
Head Diameter: 27/32"  
Stem Length: 1"  
Fits into 13/32" Hole  
GM 1987 - On

UNIT PACKAGE: 25



### 21246

(22690838)  
Black Nylon

Door Trim Push-Type Retainer  
Head Diameter: 12mm  
Stem Length: 14mm (Excluding the Pin)  
Fits into 6mm Hole  
Chevrolet Malibu & Pontiac G6 2004 - On

UNIT PACKAGE: 25

**Sec. 20**

**GENERAL MOTORS CLIPS & FASTENERS**



**20666**

(22677979, 22677980)  
Gray Nylon

Door Trim Push-Type Retainer  
Head Diameter: 12mm  
Stem Length: 14mm (Excluding the Pin)  
Fits into 6mm Hole  
Chevrolet Malibu 2004 - On

UNIT PACKAGE: 25



**14011**

(14019226, 14071289)  
Black Nylon

Radiator Overflow Bottle/Windshield Washer Bottle Retainer  
Head Diameter: 21/32"  
Stem Length: 9/16"  
Fits into 5/16" Hole  
GM 1981 - On

UNIT PACKAGE: 25



**17162**

(GM: 96057846; Hyundai: 86155-22000;  
Toyota: 90467-07041)  
Black Nylon

Push-Type Retainer  
Head Diameter: 15mm  
Stem Length: 8mm (Excluding the Pin)  
Fits into 6.3mm Hole  
Geo Metro & Tracker 1989 - On

UNIT PACKAGE: 10



**12567**

(GM: 14019205, 14019206, 16514113;  
Chry: 34201621, 6504090)  
Black Nylon

Front Fender Mud Skirt & Fender Liner Push-Type Retainer  
Head Diameter: 11/16"  
Stem Length: 9/16"  
Fits into 1/4" Hole  
GM 1981 - On

UNIT PACKAGE: 25



**19297**

(11517824, 21035345)  
Black Nylon

Liftgate Upper Window & Lower Garnish Moulding Push-Type Retainer  
Head Diameter: 16mm  
Stem Length: 12mm (Excluding the Pin)  
Fits into 7mm Hole  
GM Saturn 1998 - 93

UNIT PACKAGE: 15



**21238**

(22718369)  
Black Nylon

Fuel Tank Shield & Miscellaneous Push-Type Retainer  
Head Diameter: 26mm  
Stem Length: 12mm  
Fits into 10mm Hole  
Chevrolet Malibu & Trail Blazer 2004 - On

UNIT PACKAGE: 25



**11699**

(GM: 472434; Chry: 6031390)  
Black Nylon

Cowl Ledge Weatherstrip & Fender Liner Push-Type Retainer  
Head Diameter: 11/16"  
Stem Length: 5/8"  
Fits into 1/4" Hole  
GM 1970-On  
Chrysler 1968-On

UNIT PACKAGE: 50



**19847**

(5973823)  
Blue Nylon

Fascia Retainer  
Head Diameter: 7/8"  
Shoulder Length: 5/32"  
Stem Length: 25/32"  
Fits into 1/2" Hole  
GM 1979-On

UNIT PACKAGE: 25



**19892**

(25695687)  
Black Nylon

Radiator Support Sight Shield Push-Type Retainer  
Head Diameter: 27mm  
Shoulder Length: 7mm  
Stem Length: 18mm  
Fits into 10mm Hole  
Cadillac DeVille & Seville 2000 - On

UNIT PACKAGE: 15



**14010**

(GM: 14045480; Chry: 6508746-AA)  
Black Nylon

Fascia Retainer  
Head Diameter: 1"  
Stem Length: 23/32"  
Fits into 3/8" Hole  
GM 1982 - On and Chrysler 2009 - On

UNIT PACKAGE: 25

# GENERAL MOTORS CLIPS & FASTENERS

## Sec. 20



**12757**  
(5973400)  
Black Nylon

Fascia Retainer  
Head Diameter: 1"  
Shoulder Length: 1/8"  
Stem Length: 3/4"  
Fits into 1/2" Hole  
GM 1979 - On

UNIT PACKAGE: 15

### 16265

Same as 12757 except for unit package quantity

UNIT PACKAGE: 50



**12756**  
(5973996)  
Brown Nylon

Fascia Retainer  
Head Diameter: 1"  
Shoulder Length: 1/4"  
Stem Length: 7/8"  
Fits into 1/2" Hole  
GM 1982 - On

UNIT PACKAGE: 15



**19854**  
(21097229)  
Black Nylon

Door Handle Push-Type Retainer  
Head Diameter: 7mm  
Stem Length: 10mm  
Fits into 5mm Hole  
Saturn 2 Door & 4 Door 1999 - On

UNIT PACKAGE: 25



**14016**  
(GM: 16500308; Chry: 6500787)  
Black Nylon

Tail Light Retainer  
Top Head Diameter: 3/8"  
Stem Length: 7/16"  
Fits into 3/16" Hole  
GM & Chrysler

UNIT PACKAGE: 25



**13999**  
(20363491)  
Black Nylon

Body Side Moulding Push-Type Retainer  
Top Head Diameter: 3/8"  
Stem Length: 1/2"  
Fits into 7/32" Hole  
GM 1979 - On

UNIT PACKAGE: 25



**19522**  
(22644361)  
Black Nylon

Door Sill Trim Plate  
Push-Type Retainer  
Head Diameter: 12mm  
Stem Length: 18mm  
Fits into 6mm Square Hole  
Chev. Malibu, Olds Achieva & Cutlass 1997 - On

UNIT PACKAGE: 15



**17106**  
(GM: 22566221; Chry: 6501577)  
Black Nylon

Headlight Door Push-Type Retainer  
Top Head Diameter: 1/2"  
Stem Length: 7/16"  
Fits into 3/16" Hole  
GM Blazer & Suburban 1991 - On  
Chrysler New Yorker Landau & 5th Avenue 1988 - On

UNIT PACKAGE: 50



**19355**  
(15960621)  
Black Nylon

Rear Door Radio Speaker  
Push-Type Retainer  
Head Diameter: 17/32"  
Stem Length: 1-5/64"  
Fits into 1/4" Hole  
GM Trucks C & K 1, 2 1995 - On

UNIT PACKAGE: 25



**16816**  
(21047094)  
Black Nylon

Push-Type Retainer  
Top Head Diameter: 14mm  
Stem Length: 14mm  
Fits into 6mm Hole  
GM Saturn 1991 - On

UNIT PACKAGE: 25



**17222**  
(GM: 21075686;  
Ford: F3LY-14570-B)  
Black Nylon

Push-Type Retainer  
Head Diameter: 15mm  
Stem Length: 20mm  
Fits into 8mm Hole  
Rocker Panel, Wheel Liner & Air Inlet Duct Applications  
GM Saturn 2 Door & 4 Door Models 1991-On  
Ford

UNIT PACKAGE: 25

**Sec. 20**

**GENERAL MOTORS CLIPS & FASTENERS**



**22347**  
(GM: 11561878)  
Black Nylon

Bumper, Fender Liner, Cowl, Grille,  
Air Inlet Duct, Rocker Panel, Wheel Liner,  
Quarter Panel & Upper Deflector  
Push-Type Retainer with Sealer  
Head Diameter: 15mm  
Stem Length: 21mm  
Fits into 8mm Hole  
Various Buick, Cadillac Chevrolet,  
GMC, Hummer, Saab &  
Saturn Models 1991 - On

UNIT PACKAGE: 25



**17103**  
(GM: 15681408;  
Ford: N803709S)  
Black Nylon

Fascia Retainer  
Head Diameter: 15mm  
Stem Length: 23mm  
Fits into 6mm Hole  
GM & Ford 1986 - On

UNIT PACKAGE: 50



**17226**  
(10207146, 21077323)  
Black Nylon

Rear Door Rocker Panel to Underbody  
Bracket Push-Type Retainer  
Head Diameter: 15mm  
Stem Length: 29mm  
Fits into 8mm Hole  
GM Saturn 4 Door Models 1991 - On

UNIT PACKAGE: 25



**19801**  
(GM: 21077123; Chry: 6509103AA  
Ford: W705436-S300)  
Black Nylon

Wheel Opening Moulding  
Push-Type Retainer  
Head Diameter: 19/32" (15mm)  
Stem Length: 3/4" (19mm)  
Fits into 1/4" (6mm) Hole  
Saturn 1991 - On  
Ford 2002 - On  
Chrysler 2010 - On

UNIT PACKAGE: 25



**20542**  
(15994165)  
Black Nylon

Bumper & Rear Wheel Apron  
Push-Type Retainer  
Head Diameter: 16.5mm  
Stem Length: 27mm  
Fits into 8mm Hole  
Saturn L Series 2000 - On

UNIT PACKAGE: 25



**19639**  
(GM: 15149708; Chry: 6506008AA)  
Black Nylon

Radiator, Wheelhouse, Fender & Front  
Bumper Cover Push-Type Retainer  
Head Diameter: 17mm  
Stem Length: 16mm  
Fits into 6mm Hole  
GM C & K Trucks 1999 - On  
Jeep Liberty 2002 - On

UNIT PACKAGE: 25



**16624**  
(1636632, 20687704)  
Black Nylon

Front Bumper Fascia Retainer  
Head Diameter: 17mm  
Shoulder Length: 2mm  
Stem Length: 18mm  
Fits into 9.5mm (3/8") Hole  
Buick Riviera/Reatta 1988 - On

UNIT PACKAGE: 25



**18030**  
(Chry: 6501925; GM: 10134407)  
Black Nylon

Push-Type Retainer  
Head Size: 11/16"  
Stem Length: 13/16"  
Fits into 1/4" Hole  
Chrysler Concorde & LHS  
Dodge Intrepid & Eagle Vision 1993-On  
Coolant Recovery Reservoir  
GM 1992-On

UNIT PACKAGE: 25



**13993**  
(GM: 20510029; Ford: N803362-S;  
Chry: 34202672)  
Black Nylon

Body Retainer  
Head Diameter: 11/16"  
Stem Length: 7/8"  
Fits into 1/4" Hole  
Ford, GM & Chrysler 1984 - On

UNIT PACKAGE: 25

# GENERAL MOTORS CLIPS & FASTENERS

## Sec. 20



### 13996

(20452072, 20590899)  
Black Nylon

Exterior Body Retainer  
Head Diameter: 11/16"  
Stem Length: 7/8"  
Fits into 9/32" Hole  
GM 1984-On

UNIT PACKAGE: 25



### 20869

(GM: 88970767;  
Toyota: 90467-10183)  
Black Nylon

Front Fender Liner  
Push-Type Retainer  
Head Diameter: 18mm  
Stem Length: 7.5mm Hole  
Fits into 7mm Hole

Pontiac Vibe, Lexus and Toyota 1999 - On

UNIT PACKAGE: 10



### 20365

(10301966, 10425306)  
Black Nylon

Cowl Vent Push-Type Retainer  
Head Diameter: 18mm  
Stem Length: 13mm  
Fits into 7.5mm Square Hole  
Pontiac Aztek 2001 - On

UNIT PACKAGE: 10



### 20988

(GM: 11589289; Chrysler: 6508863-AA)  
Black Nylon

Air Distributor & Windshield Defroster  
Push-Type Retainer  
Head Diameter: 18mm  
Stem Length: 17.5mm  
Panel Range: 2.0mm - 4.5mm  
Fits into 6.5mm Hole

Buick Enclave, Chevrolet Equinox,  
Chevrolet & GMC S & T Trucks, GMC  
Acadia and Pontiac Torrent 2002 - On

UNIT PACKAGE: 25



### 20888

(GM: 11561368; Chry: 6508712AA)  
Black Nylon

Fender, Wheel & Bumper  
Push-Type Retainer  
Head Diameter: 18mm  
Stem Length: 20mm  
Panel Range: 3.0mm - 5.8mm  
Fits into 9.5mm Hole  
Chevrolet Impala & Monte Carlo and  
Pontiac Grand Prix & Solstice 2004 - On  
Jeep Wrangler 2000 - On

UNIT PACKAGE: 25



### 20880

(GM: 11589290  
Chry: 6509049-AA;  
Ford: W714040-S300)  
Black Nylon

Air Inlet Grille, Bumper Fascia &  
Front Brake Caliper Cooling Duct  
Push-Type Retainer

Head Diameter: 18mm  
Stem Length: 20mm

Panel Range: 4.5mm - 7.0mm  
Fits into 6.5mm Hole

Buick Enclave, Cadillac CTS & STS,  
Chevrolet Cobalt, Equinox & SSR, GM  
Trucks and Pontiac G5 & Torrent 2002 - On  
Chrysler Charger & 300 2011 - On

UNIT PACKAGE: 50



### 21672

(11611110)  
Black Nylon

Cowl Vent Push-Type  
Retainer with Sealer  
Head Diameter: 18mm  
Stem Length: 20mm  
Fits into 6.3mm Hole  
Buick Allure & LaCrosse  
and Chevrolet Volt 2010 - On

UNIT PACKAGE: 15



### 20989

(GM: 11589291;  
Ford: W713331-S300)  
Black Nylon

Air Dam & Grille Push-Type Retainer  
Head Diameter: 18mm  
Stem Length: 22mm  
Panel Range: 7.0mm - 9.5mm  
Fits into 6.5mm Hole  
Cadillac CTS, SRX and STS 2003 - On

UNIT PACKAGE: 25



### 21529

(95230842)  
Black Nylon

Cowl Vent Push-Type  
Retainer with Sealer  
Head Diameter: 18mm  
Stem Length: 22mm  
Fits into 6.5mm Hole  
Chevrolet Cruze 2011 - On

UNIT PACKAGE: 15

**Sec. 20**

**GENERAL MOTORS CLIPS & FASTENERS**



**22219**  
(GM: 92138636)  
Black Nylon

Air Baffle Push-Type Retainer  
Head Diameter: 18mm  
Stem Length: 23mm  
Fits into 7.5mm Hole  
Chevrolet Caprice 2013 - 2012  
Pontiac G8 and GTO 2009 - 2004

UNIT PACKAGE: 25



**20990**  
(GM: 15296830;  
Chrysler: 5116530-AA)  
Black Nylon

Fascia & General Purpose  
Push-Type Retainer  
Head Diameter: 19mm  
Stem Length: 16mm  
Panel Range: 5.0mm - 7.0mm  
Fits into 8mm Hole  
GM 2007 - On

UNIT PACKAGE: 25



**16622**  
(10157900, 11517803, 15993201)  
Black Nylon

Front Bumper Fascia Retainer  
Head Diameter: 18mm  
Stem Length: 23mm  
Fits into 9.5mm (3/8") Hole  
Olds Cutlass 1990-On  
GM Lt. Truck 1996 - On

UNIT PACKAGE: 25



**18308**  
(3540858)  
Black Nylon

Radiator Air Baffle  
Push-Type Retainer  
Large Head Diameter: 3/4"  
Stem Length: 1-1/8"  
Fits into 1/4" Hole  
Cadillac Eldorado &  
Seville 1993-On

UNIT PACKAGE: 25



**20359**  
(11519444)  
Black Nylon

Bumper Cover Push-Type Retainer  
Head Diameter: 18mm  
Stem Length: 26mm  
Fits into 10mm Hole  
Oldsmobile Intrigue, Pontiac  
Aztek & Grand Prix 1997 - On

UNIT PACKAGE: 25



**19239**  
(GM: 11519949;  
Honda: 91512-SX0-003;  
Mitsubishi: MU000319)  
Black Nylon

Fender, Interior Trim & Washer Tank  
Push-Type Retainer  
Head Diameter: 20mm  
Stem Length: 11mm  
Fits into 8mm Hole  
Buick, Cadillac, Chevrolet &  
GMC 1997 - On

UNIT PACKAGE: 25



**20631**  
(11588988)  
Black Nylon

Front Bumper Cover Push-Type Retainer  
Head Diameter: 18mm  
Stem Length: 26mm  
Fits into 10mm Hole  
Pontiac Grand Prix 2004 - On

UNIT PACKAGE: 25



**20826**  
(11609417)  
Black Nylon

Fender Apron Push-Type Retainer  
Head Diameter: 19mm  
Stem Length: 14mm  
Panel Range: 2.7mm - 5.3mm  
Fits into 8.5mm Hole

Buick Enclave & LaCrosse, Cadillac CTS, SRX & STS,  
Chevrolet Cobalt, Equinox & Malibu, GM Trucks and  
Pontiac G5, G6 & Torrent 2003 - On

UNIT PACKAGE: 50



**22100**  
(GM: 11612035)  
Black Nylon

Front Fender & Body Side Liner  
Push-Type Retainer  
Head Diameter: 20mm  
Stem Length: 12mm  
Fits into 8.5mm Hole  
Chevrolet Colorado & SS and GMC  
Canyon 2014 - On

UNIT PACKAGE: 25

# GENERAL MOTORS CLIPS & FASTENERS

## Sec. 20



### 17216

(GM: 21030249; Ford: N807389S;  
Chry: 6503598)  
Black Nylon

Air Baffle to Under Carriage  
Push-Type Retainer  
Head Diameter: 20mm  
Stem Length: 20mm  
Fits into 8mm Hole

GM Saturn 2 Door & 4 Door Models 1991 - On

UNIT PACKAGE: 25



### 16625

(10108746)  
Black Nylon

Front Bumper Fascia Retainer  
Head Diameter: 20mm  
Stem Length: 20mm  
Fits into 10mm Hole

GM Station Wagons 1991 - On

UNIT PACKAGE: 25



### 20991

(11589292)  
Black Nylon

Bumper Fascia, Flares & Air Dam  
Push-Type Retainer  
Head Diameter: 20mm  
Stem Length: 20mm  
Panel Range: 2.0mm - 4.5mm  
Fits into 8.5mm Hole

Chevrolet & GMC, C & K Trucks 2007 - On

UNIT PACKAGE: 25



### 19615

(15153415)  
Black Nylon

Rear Bumper Cover  
Push-Type Retainer  
Top Head Diameter: 20mm  
Stem Length: 21mm  
Fits into 9mm Hole

C & K Trucks 1999 - On

UNIT PACKAGE: 25



### 20889

(GM: 11589293;  
Ford: W712196-S300)  
Black Nylon

Cowl Vent & Fender Push-Type Retainer  
Head Diameter: 20mm  
Stem Length: 22mm  
Panel Range: 4.5mm - 7.0mm  
Fits into 8.5mm Hole

Buick Century, LaCrosse & Regal, Cadillac, Chevrolet  
Equinox, GM Trucks, Hummer H3 and  
Pontiac Grand Prix & Torrent 1997 - On  
Ford 2006 - On

UNIT PACKAGE: 25



### 20992

(11589294)  
Black Nylon

Bumper Fascia, Fender and Toe/Floor  
Panel Push-Type Retainer  
Head Diameter: 20mm  
Stem Length: 24mm

Panel Range: 7.0mm - 10.0mm  
Fits into 8.5mm Hole

Buick Enclave & LaCrosse, Chevrolet &  
GMC C & K Trucks, GMC Acadia,  
Hummer H3 and Saturn Outlook 2005 - On

UNIT PACKAGE: 25



### 20632

(GM: 11518017)  
Ford: W708530-S300)  
Black Nylon

Bumper Cover & Fender Shield  
Push-Type Retainer  
Head Diameter: 20mm  
Stem Length: 26mm  
Fits into 8mm Hole

GM & Ford 1997 - On

UNIT PACKAGE: 15



### 18896

(21095797)  
Black Nylon

Bumper Fascia  
Push-Type Retainer  
Large Head Diameter: 20mm  
Stem Length: 28mm  
Fits into 8mm Hole

GM Saturn 1996 - On

UNIT PACKAGE: 25

## HAVE YOU VISITED US ONLINE?

Auveco's website has been completely renovated.  
Our new design is user friendly with easy  
navigation and ordering.

Product is searchable by car make, OEM number  
and category, as well as, several attribute drop  
downs within individual categories. All product  
also has stock availability listed.

Make sure to head over to

[www.auveco.com](http://www.auveco.com)

to receive up to date information on all our products.

**Sec. 20**

**GENERAL MOTORS CLIPS & FASTENERS**



**20863**  
(5480772)  
Black Nylon

Lower Rocker Moulding  
Push-Type Retainer  
Head Diameter: 22mm  
Stem Length: 13mm  
Fits into 15mm Hole  
Chevrolet Equinox 2005 - On

UNIT PACKAGE: 10



**15043**  
(14103461)  
Black Nylon

Bumper Fascia Retainer  
Head Diameter: 7/8"  
Shoulder Length: 5/32"  
Stem Length: 1-3/64"  
Fits into 1/2" Hole  
GM 1987 - On

UNIT PACKAGE: 25



**20993**  
(GM: 11589295;  
Ford: W712665-S300)  
Black Nylon

Fender, Flare, Gas Tank & Panel  
Attachment Push-Type Retainer  
Head Diameter: 25mm  
Stem Length: 20mm  
Panel Range: 3.0mm-6.0mm  
Fits into 10.5mm Hole  
Chevrolet Cobalt & HHR, GM C & K Trucks  
and Pontiac G5 2005 - On

UNIT PACKAGE: 25



**20994**  
(GM: 11589296)  
Black Nylon

Panel Attachment &  
General Purpose  
Push-Type Retainer  
Head Diameter: 25mm  
Stem Length: 23mm  
Panel Range: 6.0mm - 9.0mm  
Fits into 10.5mm Hole  
Buick Enclave and GMC Acadia 2007 - On

UNIT PACKAGE: 25



**14020**  
(GM: 14093088; Ford: N802781-S)  
Black Nylon

Splash Shield & Fascia Retainer  
Head Diameter: 1"  
Stem Length: 7/8"  
Fits into 1/4" Hole  
GM 1979 - On

UNIT PACKAGE: 25



**14147**  
(20547865)  
Black Nylon

Body Retainer  
Head Diameter: 1"  
Stem Length: 7/8"  
Fits into 1/4" Hole  
GM 1984 - On

UNIT PACKAGE: 25



**13994**  
(GM: 20570245, 20635065  
Ford: N804614S)  
Black Nylon

Splash Shield, Seat Cushion &  
Spare Tire Retainer  
Head Diameter: 1"  
Stem Length: 7/8"  
Fits into 5/16" Hole  
GM 1984 - On

UNIT PACKAGE: 25



**18310**  
(22587036)  
Black Nylon

Rear Bumper Fascia  
Push-Type Retainer  
Head Diameter: 1"  
Stem Length: 15/16"  
Fits into 3/8" Hole  
Chevrolet Cavalier &  
Pontiac Sunfire 1995 - On

UNIT PACKAGE: 25



**15702**  
(14101262)  
Black Nylon

Plastic Cover on Engine  
Compartment Retainer  
Head Diameter: 1"  
Shoulder Length: 1/8"  
Stem Length: 15/16"  
Fits into 1/2" Hole  
Buick, Olds & Pontiac 1988 - On

UNIT PACKAGE: 25





**15044**

(22535007)  
Black Nylon

Bumper Fascia Retainer  
Head Diameter: 1"  
Shoulder Length: 1/8"  
Stem Length: 1"  
Fits into 1/2" Hole  
GM 1987 - On

UNIT PACKAGE: 25



**15045**

(10053388, 22542705)  
Black Nylon

Bumper Fascia Retainer  
Head Diameter: 1"  
Shoulder Length: 1/8"  
Stem Length: 1-7/64"  
Fits into 1/2" Hole  
GM 1987-On

UNIT PACKAGE: 25



**15042**

(10077283)  
Black Nylon

Bumper Fascia Retainer  
Head Diameter: 1"  
Shoulder Length: 1/4"  
Stem Length: 1-1/8"  
Fits into 1/2" Hole  
GM 1982-On

UNIT PACKAGE: 25



**21361**

(GM: 11561874;  
Nissan: 622A2-9E000A)  
Black Nylon

Bumper Cover  
Push-Type Retainer  
Head Diameter: 25mm  
Stem Length: 29mm  
Fits into 7mm Hole  
Chevrolet Malibu, Pontiac G6  
and Saturn Aura 2007 - On  
Nissan Altima 1997 - On

UNIT PACKAGE: 15



**18268**

(15959832)  
Black Nylon

Front License Plate Bracket  
Push-Type Retainer  
Head Diameter: 1"  
Shoulder Length: 9/64"  
Stem Length: 1-5/8"  
Fits into 1/2" Hole  
GM Truck 1994-On

UNIT PACKAGE: 5



**18334**

(15959833)  
Gray Nylon

Front License Plate Bracket  
Push-Type Retainer  
Head Diameter: 1"  
Stem Length: 1-3/4"  
Fits into 1/2" Hole  
GM S-10 Truck  
with Decor Package  
1994-On

UNIT PACKAGE: 5



**17616**

(21077131)  
Black Nylon

Bumper Fascia  
Push-Type Retainer  
Head Diameter: 1-3/16"  
Stem Length: 2"  
Fits into 7/16" Hole  
GM Saturn 1991-On

UNIT PACKAGE: 10

**Sec. 20**

**GENERAL MOTORS CLIPS & FASTENERS**



**21176**

(10382313)  
Black Nylon

Sight Shield &  
Trim Push-Type Retainer  
Head Diameter: 24.5mm  
Stem Length: 13mm  
Fits into 9mm Hole  
Cadillac STS, Pontiac Solstice  
and Saturn Sky 2005 - On

UNIT PACKAGE: 10



**20244**

(25707329)  
Green Nylon

Push-Type Retainer with Sealer  
Head Diameter: 19mm  
Stem Length: 32mm  
Fits into 8mm Hole  
Buick LeSabre, Oldsmobile Aurora  
& Pontiac Bonneville 2000 - On

UNIT PACKAGE: 10



**20163**

(25099299)  
Black Nylon

Radiator Sight Shield &  
Air Filter Housing  
Push-Type Retainer  
Head Diameter: 12.5mm  
Stem Length: 17mm  
Fits into 6mm Hole  
1994 - On

UNIT PACKAGE: 15



**19417**

(Chry: 6503819, 6503401;  
GM: 25631448)  
Black Nylon

M7.5 x 35mm  
Square Drive Truss Head  
Head Diameter: 22mm  
Shoulder Diameter: 9mm  
Foam to Bumper Fascia  
Chrysler 1993 - On  
GM 1997 - On

UNIT PACKAGE: 15



**18353**

(15960325)  
White Nylon

Door Trim Panel  
Push-Type Retainer  
Head Diameter: 9/16"  
Stem length: 41/64"  
Fits into 1/4" Hole  
GM Trucks C, K, 1, 2, 3 1995-On

UNIT PACKAGE: 50



**21517**

(25705182)  
Black Nylon

M9.5 x 46mm  
Bumper Fascia Nylon Screw  
Head Diameter: 22mm  
Square Drive  
Cadillac Escalade & XLR,  
Chevrolet Avalanche & Tahoe and  
GMC Suburban, Yukon &  
Yukon Denali 2004 - On

UNIT PACKAGE: 25



**21400**

(10426555)  
Natural Nylon

Front Bumper  
Push-Type Retainer  
Top Head Diameter: 24.5mm  
Bottom Head Diameter: 23.5mm  
Stem Length: 36mm  
Fits into 10mm Hole  
Buick Allure & LaCrosse,  
Chevrolet Impala & Monte Carlo  
and Pontiac Grand Prix 2000 - On

UNIT PACKAGE: 15



**20970**

(Not Available from O.E.M.)  
Black Nylon

M14 x 34mm  
Bumper and Door Insulator  
Nylon Screw  
Head Outer Diameter: 22mm  
No. 3 Square Drive  
Fits into 12mm Hole  
GM, Ford & Chrysler 2005 - On

UNIT PACKAGE: 25



**19387**

(15989487)  
Nylon

Front & Rear Door Trim Panel Retainer  
Astro & Safari Mini-Van,  
S & T Trucks 1996-On

UNIT PACKAGE: 10

# GENERAL MOTORS CLIPS & FASTENERS

## Sec. 20



**13860**  
(20478294)  
Black Nylon

Carpet Retainer  
Head Diameter: 30mm  
Fits onto 6mm Stud  
GM 1984-On

UNIT PACKAGE: 25



**21377**  
(11609483)  
Black Nylon

Rear Hatch Sill Plate Retainer  
Top Head Diameter: 12mm  
Bottom Head Size: 17mm x 34mm  
Stem Length: 15mm  
Chevrolet HHR 2006 - On

UNIT PACKAGE: 10



**18691**  
(10186453)  
Black Nylon

Dash Sound Barrier Retainer  
Flange Diameter: 30mm  
Overall Length: 52mm  
Chevrolet Lumina APV,  
Olds Silhouette and  
Pontiac Trans Sport 1990-On

UNIT PACKAGE: 25



**21302**  
(11610748)  
Black Nylon

Grille Retainer Nut  
Hex: 13mm  
Washer Diameter: 25mm  
Overall Height: 7mm  
**Mates with Auveco 21301**  
Cadillac SRS & SRX and  
Chevrolet Camaro 2010 - On

UNIT PACKAGE: 25



**16953**  
(12337900, 14103435)  
Nylon

Upper Radiator Shield Retainer  
Chevrolet Corsica & Beretta 1987-On

UNIT PACKAGE: 10



**13856**  
(20461373)  
Nylon

Rear Speaker Nut  
Thread: M6 - 1.0  
GM 1984-On

UNIT PACKAGE: 25



**21164**  
(11610049)  
Black Nylon

Bumper Cover Turn & Lock Retainer  
Overall Length: 24.5mm  
Buick Enclave, Cadillac Escalade,  
Chevrolet Suburban & Traverse and  
GMC Acadia & Yukon 2007 - On

UNIT PACKAGE: 25



**13456**  
(20478295)  
Nylon

Carpet Retainer  
GM 1985-On

UNIT PACKAGE: 10



**19472**  
(GM: 25535963; Ford: N811772S)  
Nylon

Instrument Panel Insulation and  
Front Compartment Rear Sight  
Shield Turn Retainer  
Buick Electra, LeSabre, Park Ave. &  
Skylark, Cadillac DeVille, Oldsmobile  
Achieva, Cutlass, Delta 88, 88 Royale & 98  
Regency And Pontiac Bonneville  
& Grand Am 1991 - On  
Upper Deflector Shield  
Ford

UNIT PACKAGE: 25



**19440**  
(12040984)  
Black Nylon

Wire Loom Routing Clip  
Inner Diameter: 1/4"  
Outer Diameter: 3/8"

UNIT PACKAGE: 15



**19795**  
(12015631)  
Black Nylon

Wire Loom Routing Clip  
Inner Diameter: 1/4"  
Outer Diameter: 3/8"

UNIT PACKAGE: 15

**Sec. 20**

**GENERAL MOTORS CLIPS & FASTENERS**



**14544**

(8911473)  
Black Nylon

Wire Loom Routing Clip  
Inner Diameter: 1/32"  
Outer Diameter: 1/2"

UNIT PACKAGE: 25



**19851**

(12040983)  
Black Nylon

Wire Loom Routing Clip  
Inner Diameter: 1/2"  
Outer Diameter: 11/16"

UNIT PACKAGE: 15



**20471**

(8905794)  
Black Nylon

Wire Loom Routing Clip  
Inner Diameter: 10mm  
Outer Diameter: 13mm

UNIT PACKAGE: 15



**14547**

(3816659, 8917320)  
Black Nylon

Wire Loom Routing Clip  
Inner Diameter: 3/4"  
Outer Diameter: 1"

UNIT PACKAGE: 25



**20397**

(12160858)  
Gray Nylon

Wire Loom  
Routing Clip  
Inner Diameter: 10mm  
Outer Diameter: 13mm

UNIT PACKAGE: 15

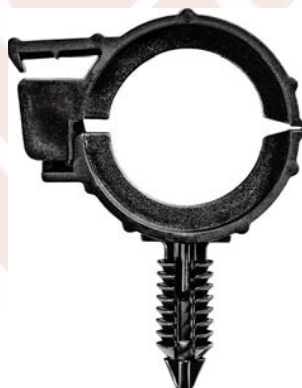

**20665**

(12160374)  
Black Nylon

Wire Loom Routing Clip  
Inner Diameter: 19mm  
Outer Diameter: 24mm

UNIT PACKAGE: 15



**14545**

(8911497)  
Black Nylon

Wire Loom Routing Clip  
Inner Diameter: 13/32"  
Outer Diameter: 19/32"

UNIT PACKAGE: 25



**16941**

(12015983)  
Black Nylon

Wire Loom  
Routing Clip  
Inner Dia.: 1"  
Outer Dia.: 1-9/32"

UNIT PACKAGE: 25



**14546**

(8911472)  
Black Nylon

Wire Loom Routing Clip  
Inner Diameter: 1/2"  
Outer Diameter: 11/16"

UNIT PACKAGE: 25

# GENERAL MOTORS CLIPS & FASTENERS

## Sec. 20



**20514**  
(12160857)  
Gray Nylon

Wiring Harness Clip  
Head Size: 9mm x 37mm  
Fits into 6.3mm (1/4") Hole  
GM

UNIT PACKAGE: 50



**19853**  
(12176844)  
Gray Nylon

Wiring Harness Clip  
Size: 3/8" x 2-1/2"  
Stem Length: 1/2"  
Fits into 1/4" Hole  
GM

UNIT PACKAGE: 25



**13858**  
(20430956)  
Nylon

Wire Clip  
Models with Sunroof  
GM 1984-On

UNIT PACKAGE: 25



**14217**  
(GM: 1257702, 20346654;  
Ford: 383207-S; AMC: 3693099)  
Nylon

Routing Clip  
GM, Ford & AMC

UNIT PACKAGE: 25



**21203**  
(Not Available from O.E.M.)  
Gray Nylon

*Photo not actual size*

Cable Tie  
Overall Length: 155mm (6-1/8")  
Width: 5mm (3/16")  
Maximum Bundle Diameter: 30mm (1-3/16")  
Fits into 6.3mm (1/4") Hole  
GM and Universal

UNIT PACKAGE: 25



**12729**  
(25512081)  
Nylon

Engine Compartment Wire Clip  
For 1/4" Diameter Tube  
Buick with V-6 Diesel 1985-On

UNIT PACKAGE: 25



**21284**  
(5482087)  
White Nylon

Grille Clip  
Overall Height: 14mm (9/16")  
Chevrolet Equinox 2005 - On

UNIT PACKAGE: 25



**18402**  
Phosphate & Green  
Weatherstrip Clip  
GM

UNIT PACKAGE: 25



**22065**  
(Not Available from O.E.M.)  
Black Phosphate

Door & Quarter Glass Channel Clip  
Width: 9mm  
Length: 16mm  
Overall Height: 13mm  
GM

UNIT PACKAGE: 50



**18395**  
Black Phosphate  
Weatherstrip Clip  
GM

UNIT PACKAGE: 50

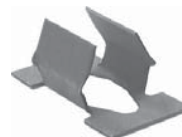

**11831**  
(554343, 562327; 1241972)

Bumper Fastener  
GM 1973-On

UNIT PACKAGE: 50



**14968**  
(10005510)

Bumper Impact Strip Retainer  
GM 1978-On

UNIT PACKAGE: 50

**Sec. 20**

**GENERAL MOTORS CLIPS & FASTENERS**



**21187**

(Chrysler: 4806226-AA; GM: 11562364)  
Zinc

Front & Rear Bumper  
and Grille Fastener  
Screw Size: #6  
Width: 10mm

Overall Height: 18mm  
Buick Lucerne and Cadillac CTS & STS 2005 - On  
Chrysler 300, Dodge Nitro  
and Jeep Commander 2005 - On

UNIT PACKAGE: 15



**20268**

(11588650, 15748479)  
Black

Garnish Moulding Fastener  
Width: 1/2"  
Height: 5/8"

GM Cars & Trucks 1994 - On

UNIT PACKAGE: 25



**11352**

(3920179,  
10013764)

Radiator Shroud Clip  
Chevrolet 1968-On

UNIT PACKAGE: 100



**20883**

(11588650)  
Zinc

Garnish, Interior Trim, Bezel  
& Scuff Plate Fastener  
Width: 15/32"  
Height: 11/16"

GM Cars & Light Trucks 2002 - On

UNIT PACKAGE: 10



**21387**

(15683327)  
Phosphate

Front Door Interior Trim &  
Instrument Panel Fastener  
Width: 13/16"  
Length: 15/16"

Chevrolet & GMC Trucks 2003 - On

UNIT PACKAGE: 10



**21745**

(GM: 11609651)  
Zinc

Windshield Garnish and Interior  
Trim Moulding Fastener  
Screw Size: M4.2 (#8)  
Stem Width: 13mm

Head Size: 13.5mm x 20.5mm  
Overall Length: 22mm

Buick Enclave & Encore; Cadillac CTS, Escalade,  
STS & XTS; Chevrolet Avalanche, Camaro, Cobalt,  
Corvette, HHR, Impala, Malibu, Monte Carlo,  
Silverado, Suburban, Tahoe & Traverse; Dodge Truck;  
Ford Flex & Taurus; GMC Sierra & Yukon;  
Kia Sorento & Soul; Pontiac G6 & G8;  
Saturn Outlook and Suzuki Grand Vitara 2004 - On

UNIT PACKAGE: 15



**20860**

(15078238)  
Black

Radiator Grille &  
Bumper Cover Fastener  
Width: 5/8"  
Length: 1"

Overall Height: 5/8"  
GM Trucks & Vans 1999 - On

UNIT PACKAGE: 15



**17356**

(96061863)  
Nylon

Radiator Grille Clip  
Geo Tracker 2 Wheel & 4 Wheel Drive 1989-On

UNIT PACKAGE: 5



**19519**

(GM: 16662182;  
Chrysler: 6502988)  
Zinc Organic

Windshield Garnish Moulding,  
Rear Side Door Garnish Moulding  
& Liftgate Trim Finish Panel Fastener  
Width: 1/2"  
Height: 9/16"

Chevrolet Camaro, Corvette, &  
Venture; Oldsmobile Silhouette and  
Pontiac Firebird, Grand Prix &  
Trans Sport 1993 - On  
Chrysler 1996 - On

UNIT PACKAGE: 15



**22025**

(GM: 13365058)  
Black Nylon

Engine Under Cover Retainer  
Head Size: 18mm x 20mm  
Stem Length: 30mm  
Overall Length: 32mm

Fits into 10mm x 10.5mm Hole  
Buick Lacrosse & Regal, Cadillac XTS and Chevrolet  
Impala, Malibu & Spark 2010 - On

UNIT PACKAGE: 15

# GENERAL MOTORS CLIPS & FASTENERS

## Sec. 20



**18262**

(15002520, 15682898)  
Zinc Organic

Radiator Grille Retainer  
GM Pickup, Van, Blazer,  
Jimmy 1994-On

UNIT PACKAGE: 25



**18748**

(22527147)  
Black Nylon

Radiator Grille Retaining Clip  
Oldsmobile Calais & Delta 88 Royale 1986  
Pontiac Bonneville 1991-88

UNIT PACKAGE: 15



**21027**

(11518531)  
Zinc Organic

Fender Bracket Interior Trim, Door,  
Bumper & Hood Retainer Nut  
Screw Size: #8 (M4.2-1.41)  
Buick Enclave & Lucerne, Chevrolet Equinox & Malibu,  
Hummer and Pontiac G5, G6, G8 & Solstice 2003 - On

UNIT PACKAGE: 15



**18153**

(11561448, 15686142)  
Zinc Phosphate

Radiator Grille Nut  
Screw Size: #8  
GM Trucks C & K, 1, 2 & 3 1993-On

UNIT PACKAGE: 25



**22289**

(GM: 11570654; Chrysler: 6509432AA  
Ford: W716529-S900)  
Magni-565 Blue Finish

Radiator Grille Nut  
Screw Size: M4.2-1.41 (#8)  
Head Size: 6mm x 16mm  
Overall Height: 7mm

Buick Allure, Enclave, Encore, LaCrosse,  
Lesabre, Lucerne, Rainer, Regal & Verano and  
Cadillac ATS, CTS, Deville, DTS, ELR,  
Escalade, SRX & STS 2000 - On  
Chrysler 200, 300, PT Cruiser, Sebring, Town &  
Country and Dodge Avenger, Caliber, Charger, Dart,  
Grand Caravan, Ram 2500 & Ram 3500 2015 - 2006  
Ford 250, 350, 450 & 550 Super Duty Trucks  
2015 - 2013

UNIT PACKAGE: 25



**21754**

(GM: 11609952)  
Magni-565 Plating

Front Bumper Specialty Nut  
Screw Size: M4.2-1.41 (#8)  
Head Size: 6mm x 16mm  
Overall Height: 7mm  
Cadillac Escalade, Chevrolet Tahoe  
and GMC Yukon 2007 - On

UNIT PACKAGE: 25



**21524**

(11610157)  
Zinc Organic

Center Console Door, Front Lights,  
Grille, Instrument Panel & Lift Gate  
Nut with Silicone Pad  
Screw Size: M4.2-1.41 (#8)  
Cadillac CTS, Chevrolet Corvette, Equinox,  
Malibu & Traverse, Hummer H3, Pontiac  
G6 and Saturn Ion 2003 - On

UNIT PACKAGE: 10



**21753**

(GM: 11562503)  
Zinc Organic

Specialty Nut with Plastisol Pad  
Screw Size: M6-1.0  
Head Size: 13mm x 13mm  
Stem Length: 8mm  
Chevrolet Truck & GMC 2008 - On

UNIT PACKAGE: 10



**14820**

(GM: 14083173,  
17988488, 17997722,  
Ford: N803685S)  
Phosphate

Dash Panel Nut  
Screw Size: #8 (M4.2-1.41)  
GM & Ford 1982-On

UNIT PACKAGE: 25



**22040**

(GM: 11610544)  
Zinc Organic

Front Fender Panel Nut  
Screw Size: M6-1.0  
Overall Height: 12mm  
Buick Allure, LaCrosse & Regal 2012 - On

UNIT PACKAGE: 10

**Sec. 20**

**GENERAL MOTORS CLIPS & FASTENERS**

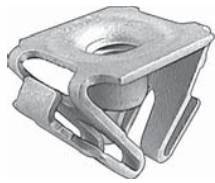

**19317**

(15707256)  
Zinc Organic

Front Fender Extension & License  
Plate Bracket Retainer Nut  
Screw Size: M6-1.0  
GM Express & Savanna 1996-On

UNIT PACKAGE: 10



**20742**

Zinc & Yellow

M4-.7 Specialty Insert  
Grip: 2mm - 3.3mm  
Head Diameter: 9.5mm  
Hex Size: 6.2mm

**Can be set with Auveco tool 11805**

UNIT PACKAGE: 15



**22117**

(GM: 11518937)  
Zinc Organic

Radiator Grille & Front End Panel Nut  
Thread Size: M6-1.0  
Overall Height: 11mm  
Buick Allure & LaCrosse, Chevrolet Impala &  
Monte Carlo, GMC Sierra & Yukon and  
Pontiac Grand Prix 2004 - On

UNIT PACKAGE: 10



**20678**

Zinc & Yellow

M5-.8 Specialty Insert  
Grip: .5mm - 3.3mm  
Head Diameter: 10mm  
Hex Size: 7mm

**Can be set with Auveco tool 11805**

UNIT PACKAGE: 15



**17508**

(15632790)  
Zinc Organic

Grille Clip  
GM S-10 & S-15  
Pick-Ups 1991-On

UNIT PACKAGE: 5



**19220**

(10237960)  
Zinc & Yellow

M6-1.0 Specialty Insert  
Grip: .7mm - 4.2mm  
Head Diameter: 12.5mm  
Inside Door Handle, Window Regulator &  
Air Bag Module Attachment  
Chevrolet Lumina, Monte  
Carlo & Pontiac Grand Prix 1995-On

**Can be set with Auveco tool 11805**

UNIT PACKAGE: 25



**22277**

(GM: 11547446)  
Black Finish

Door Panel Clip  
Head Size: 16.5mm x 25mm  
Stem Length: 13mm  
Chevrolet Colorado, Silverado,  
Suburban & Tahoe and GMC Canyon,  
Sierra & Yukon 2015 - On

UNIT PACKAGE: 10



**20415**

(GM: 15685099;  
Ford: N803763-S100)  
Zinc & Yellow

M6-1.0 Specialty Insert with Sealer  
Grip: .65mm - 2.0mm  
Head Diameter: 12mm  
Hex Size: 8mm  
Roof Rack, Tailgate & General Purpose GM APV Vans,  
C & K Trucks and Ford Explorer 1991 - On

**Can be set with Auveco tool 11805**

UNIT PACKAGE: 15



**17382**

(14100784)  
Phosphate

Bumper Valance Panel Retainer  
Cadillac Eldorado & Seville  
Chevrolet Lumina & Beretta 1987-On

UNIT PACKAGE: 25



**20395**

(10281487)  
Zinc & Yellow

M6-1.0 Specialty Insert  
Grip: .7mm-4.2mm  
Head Diameter: 13mm  
Hex Size: 9.5mm (3/8")  
Front Fender  
Buick, Cadillac, Corvette, L.D. Truck, Olds  
Aurora and Pontiac 1997 - On

**Can be set with Auveco tool 11805**

UNIT PACKAGE: 15



**20396**

Zinc & Yellow

1/4" - 20 Specialty Insert  
Grip: .030" - .165"  
Head Diameter: 1/2"  
Hex Size: 3/8"

**Can be set with Auveco tool 11805**

UNIT PACKAGE: 15





**20422**  
(11519952)  
Zinc

M6-1.0 Specialty Insert  
Grip: .7mm-4mm  
Head Diameter: 13mm  
Hex Size: 9.5mm (3/8")  
Front Core Support & General Purpose  
GM Envoy & Trailblazer 2002 - On  
**Can only be set with Pneumatic tool**

UNIT PACKAGE: 15



**22035**  
(GM: 11609292)  
Zinc

M6-1.0 Specialty Insert with Sealer  
Grip: .5mm - 4.2mm  
Head Diameter: 13mm  
Hex Size: 9.5mm  
Roof Rack & Luggage Carrier  
Buick, Chevrolet, GMC,  
Hummer & Saturn 2012 - 06  
**Can be set with Auveco tool 11805**

UNIT PACKAGE: 10



**22121**  
(GM: 11609836)  
Tin-Zinc Finish

Specialty Insert  
Thread Size: M8-1.25  
Grip Range: .70mm - 3.80mm  
Head Diameter: 17mm  
Hex Size: 12.5mm  
General Purpose  
Cadillac XLR &  
Chevrolet Corvette 1997 - On  
**Can only be set with Pneumatic tool**

UNIT PACKAGE: 10



**20423**  
(11519960)  
Zinc

M8-1.25 Specialty Insert  
Grip: .7mm-4mm  
Head Diameter: 17mm  
Hex Size: 12.5mm (1/2")  
Front Core Support & General Purpose  
GM Envoy & Trailblazer 2002 - On  
**Can only be set with Pneumatic tool**

UNIT PACKAGE: 15



**9367**  
(4495047)

Front Seat Arm Support  
Hinge Pin Retainer  
GM

UNIT PACKAGE: 100



**15459**  
(1247872, 15567924)

Throttle Rod Retaining Clip  
For 1/4" Rod with 5/32" Groove  
Outer Diameter: 19/32"  
GM 1975-On

UNIT PACKAGE: 50



**21351**  
(11588441)  
Zinc

Fender, Quarter Panel & Grille  
Push-On Retainer  
Stud Size: 6mm  
Outer Diameter: 24mm  
GM & Hummer 2002 - On

UNIT PACKAGE: 50

**21290**  
(15769308: Retainer, 15040331: Ring)  
Zinc

*Photos not actual size*

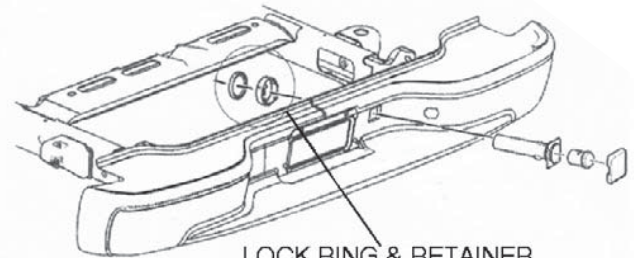

**LOCK RING & RETAINER**  
The retainer and ring are damaged  
whenever the bumper is removed.

Spare Tire Lock Cylinder Housing Retainer  
& Lock Ring Kit  
Retainer Outer Diameter: 72mm  
Lock Ring Outer Diameter: 57mm  
GM C/K, Denali, Sierra, Silverado, Suburban,  
Tahoe and Yukon 1999 - On

UNIT PACKAGE: 5 Kits

**Sec. 20**

**GENERAL MOTORS CLIPS & FASTENERS**



**20562**  
(9601750)

Door Lock Striker  
Bolt Assembly  
with PVC Plastic Bushing  
Thread: 1/2" - 13  
Overall Length: 2-1/4"  
GM Cars &  
Trucks 1991 - 73

UNIT PACKAGE: 1



**17069**  
(16606936, 16633853)  
White Nylon

Door Lock Rod Clip  
Rod Size: 4mm  
Head Diameter: 10mm  
GM 1982-On

UNIT PACKAGE: 100



Left-Hand Side



Right-Hand Side

**10262**  
Nylon

Door Lock Rod & Hood  
Latch Locking Push Rod Clip  
Rod Size: 5/32"  
Fits into 1/4" Hole  
Chrysler, Ford, GM & AMC

UNIT PACKAGE: 20 Pieces  
10 Rights - 10 Lefts



**20675**  
(AMC: 4003672R;  
Chry: 2945108R, 4658676;  
GM: 16627328, Ford: N805350S)  
White Nylon

Clip for Right-Hand Side Only

UNIT PACKAGE: 25



**14967**  
(AMC: 4003673L;  
Chry: 2945109L, 4658677;  
GM: 9815325, 16607593;  
Ford: D2VZ-6521952A, N804344S)  
Black Nylon

Clip for Left-Hand Side Only

UNIT PACKAGE: 50



**18392**  
(20582532)  
Black Nylon

Door Lock Rod Clip  
Rod Size: 5/32"  
Buick Regal & Roadmaster Chevrolet Caprice,  
Olds Custom Cruiser & Cutlass and  
Pontiac Grand Prix 1992-On

UNIT PACKAGE: 25



**18393**  
(20582533)  
Natural Nylon

Door Lock Rod Clip  
Rod Size: 5/32"  
Buick Regal & Roadmaster Chevrolet Caprice,  
Olds Custom Cruiser & Cutlass and  
Pontiac Grand Prix 1992-On

UNIT PACKAGE: 25



**15673**  
(GM: 8891031;  
Chrysler: 3454220, 4658676)  
Red Nylon

Door Lock Rod Clip  
Used on Right-Hand Side  
Rod Size: 5/32"  
GM C & K Pickups 2007 - 1999  
Chrysler 1972 - On

UNIT PACKAGE: 50



**15674**  
(GM: 8891030;  
Chrysler: 3454221, 4658677)  
Green Nylon

Door Lock Rod Clip  
Used on Left-Hand Side  
Rod Size: 5/32"  
GM C & K Pickups 2007 - 1999  
Chrysler 1972 - On

UNIT PACKAGE: 50



**21196**  
(16630688)  
White Nylon

Door Lock Rod Clip  
Used on Right-Hand Side  
Rod Size: 3/16" (5mm)  
GM Pick-Up Trucks 1999 - On

UNIT PACKAGE: 25

# GENERAL MOTORS CLIPS & FASTENERS

## Sec. 20



**21197**

(16630689)  
Black Nylon

Door Lock Rod Clip  
Used on Left-Hand Side  
Rod Size: 3/16" (5mm)  
GM Pick-Up Trucks 1999 - On

UNIT PACKAGE: 25



**18926**

(14037239, 15545178)  
Natural Nylon

Tailgate Rod Clip  
Rod Size: 3/16"  
GM Trucks C, K 1, 2, 3 1981-On

UNIT PACKAGE: 10



**19658**

(16629990, 16675980)  
Gray Nylon

Door Lock Rod Clip  
Rod Size: 5/32"  
Buick, Cadillac, Chevrolet, Oldsmobile,  
Pontiac & Trucks 1996 - On

UNIT PACKAGE: 15



**15518**

(4234830, 12337868)

Door Lock Rod Clip  
GM 1964-On

UNIT PACKAGE: 25



**15759**

(3998009, 9711304)

Door Lock Rod Clip  
GM 1956-On

UNIT PACKAGE: 50

**20872**

Stainless Steel  
Tailgate  
Support Straps



*Photo not actual size*

2004 - 1999 full size GM Pick-Up Trucks are equipped with galvanized, braided steel tailgate cables that may corrode, weaken and eventually break. Auveco's support straps are the ideal replacement. Our straps are stronger and more durable than cable. It mounts the same as the original cable, uses the same hardware and can be installed in 15 minutes. And can be used for both sides of the tailgate.

UNIT PACKAGE: 1

## GM Truck Door Hinge Pin & Bushing Repair Kits

Why bother with the hassle of cutting and grinding off a worn door hinge and welding on a new one when you can repair the bad hinge in a fraction of the time?

With our Door Hinge Pin & Bushing Repair Kits, fixing sagging doors caused by worn hinges due to pin failure is quick. It's easy. It works. And you don't have to repaint the welded heat flash area.

Each kit is designed to repair one hinge and contains all the pins, bushings and related hardware to do the job.

**Refer to Kit listings below and on following pages.**

*Photos not actual size.*



**20485**

(89025539)

Door Hinge Pin and Bushing Kit  
Cadillac Escalade 2006 - 2000  
Chevrolet Silverado & GMC Sierra:  
1500/2500, HD / 3500, HD  
2007 - 1999

Chevrolet Suburban  
1500/2500 &  
Tahoe 2006 - 2000  
GMC Yukon  
2006 - 2001

UNIT PACKAGE: 1 Kit



**21092**

(89025543)

Extended Cab Rear Door Hinge  
Pin and Bushing Kit  
Chevrolet Silverado & GMC Sierra:  
1500/2500/3500  
2005 - 1999

1500HD/2500HD/3500HD  
2005 - 2001  
1500/2500HD  
Classic Hybrid LT 2007 - 2006  
1500 Classic Hybrid 2007 - 2005

UNIT PACKAGE: 1 Kit

**Sec. 20**

**GENERAL MOTORS CLIPS & FASTENERS**

Door Hinge Pin & Bushing Repair Kits

*Photos not actual size*



**21740**  
(GM: 19302122)  
Greaseable  
Stainless Steel  
Door Hinge Pin &  
Bushing Kit  
Repairs One (Upper or  
Lower) Extended Cab,  
Rear Door Hinge  
GM Full-Size Pickups and  
SUV's 2006 - 1999

UNIT PACKAGE: 1 Kit



**21741**  
(GM: 19301966)  
Greaseable Stainless  
Steel Door Hinge Pin  
& Bushing Kit  
Repairs One (Upper or  
Lower) Right &  
Left Rear Door Hinge  
Chevrolet & GMC  
Full-Size Vans  
2014 - 1996

UNIT PACKAGE: 1 Kit



**21072**  
(89025546)  
Greaseable  
Stainless Steel  
Side Cargo Door  
Hinge Pin &  
Bushing Kit  
GM Savana Van &  
Express Van  
2008 - 1996

UNIT PACKAGE: 1 Kit

**21610**  
(12338074, 15562609, 15562610, 15653790, 15691493,  
15964971, 15964972, 16632192 & 16632193)



Door Hinge Pin & Bushing Kit  
Repairs one Hinge  
Contains one Auveco 19781 pin,  
one each of Auveco bushings  
16936 & 16937 and one of  
17976 pin retainer  
GM S & T Trucks 1994 - On

UNIT PACKAGE: 1 Kit

**21644**

(12338074, 15562609, 15562610, 15591860,  
15691493, 15691595, 15964971, 15964972, 15967691,  
16632192, 16632193, 88891731)



Door Hinge Pin & Bushing Kit  
Repairs One Hinge  
Contains one Auveco pin 19424, one each of  
Auveco bushings 16936 & 16937 and  
one of Auveco 17976 pin retainer  
GM C & K Trucks 1988 - On

UNIT PACKAGE: 1 Kit

**21403**

(19260060)



Greaseable Stainless Steel  
Door Hinge Pin, Bushing & Bracket Repair Kit  
Repairs One (Upper or Lower)  
Driver's Side Hinge  
Cadillac Escalade 2006 - 2002  
Chevrolet Avalanche 2006 - 2002  
Chevrolet Silverado 2006 - 1999  
Chevrolet Silverado Classic 2007  
Chevrolet Suburban 2006 - 2000  
Chevrolet Tahoe 2005 - 2000; GMC Sierra 2006 - 1999  
GMC Sierra Classic SLE 2007; GMC Yukon 2002  
GMC Yukon Denali 2004 - 2001  
GMC Yukon S 2006 - 2005; GMC Yukon SLE 2000

UNIT PACKAGE: 1

**All items available in  
bulk quantities.**

**Call customer service  
1-800-354-9816  
for a price quote**

# GENERAL MOTORS CLIPS & FASTENERS

## Sec. 20

Door Hinge Pin & Bushing Repair Kits

*Photos not actual size*



**21404**  
(19260058)  
Greaseable Stainless Steel  
Door Hinge Pin, Bushing & Bracket Repair Kit  
Repairs One (Upper or Lower)  
Passenger's Side Hinge

Cadillac Escalade 2006 - 2002  
Chevrolet Avalanche 2006 - 2002  
Chevrolet Silverado 2006 - 1999  
Chevrolet Silverado Classic 2007  
Chevrolet Suburban 2006 - 2000  
Chevrolet Tahoe 2005 - 2000; GMC Sierra 2006 - 1999  
GMC Sierra Classic SLE 2007; GMC Yukon 2002  
GMC Yukon Denali 2004 - 2001  
GMC Yukon S 2006 - 2005 ; GMC Yukon SLE 2000

UNIT PACKAGE: 1



**21406**  
(19260061)  
Greaseable Stainless Steel  
Door Hinge Pin & Bushing Repair Kit  
Repairs Two Hinges

Cadillac Escalade & Escalade ESV; Chevrolet  
Avalanche 4-door pickup/SUV, Silverado, Suburban  
4-door extended SUV, & Tahoe 4-door SUV;  
GMC Sierra, Yukon & Yukon XL 2013 - 2007

UNIT PACKAGE: 1



**21405**  
Stainless Steel  
Door Hinge Pin & Bushing Repair Kit  
Repairs Two Hinges

Cadillac Escalade & Escalade ESV; Chevrolet  
Avalanche 4-door pickup/SUV, Silverado, Suburban  
4-door extended SUV, & Tahoe 4-door SUV;  
GMC Sierra, Yukon & Yukon XL 2013 - 2007

UNIT PACKAGE: 1



**21582**  
(GM: 19260663)

Greaseable Stainless Steel  
Door Hinge Pin & Bushing Repair Kit  
Repairs Two Side Cargo Door Hinges  
Chevrolet Express & GMC Savana Van 2013 - 2009

UNIT PACKAGE: 1



**21444**  
(19260063)  
Greaseable Stainless Steel  
Door Hinge Roller Pin Kit  
Repairs one  
Driver's or Passenger's Side  
Lower Hinge  
Chevrolet Silverado  
2013 - 2007  
GMC Sierra 2013 - 2007  
and Related Suv's (T-900)

UNIT PACKAGE: 1

Sec. 20

GENERAL MOTORS CLIPS & FASTENERS

Door Hinge Pin & Bushing Repair Kits

Photos not actual size



21487  
(19260056)

Greaseable Stainless Steel  
Door Hinge Pin &  
Bushing Repair Kit  
Repairs One Front  
(Upper or Lower)  
Door Hinge  
Buick Rainier,  
Chevrolet Trailblazer  
and GMC Envoy  
2011 - 02

UNIT PACKAGE: 1

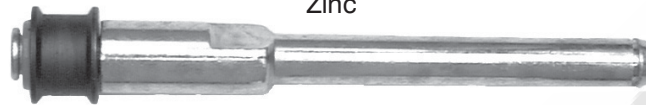

19782  
(15672183)  
Zinc

Door Hinge Roller Pin Assembly  
Pin Diameter: 25/64"  
Overall Length: 5-1/16"  
Roller Outer Diameter: 3/4"  
Roller Groove Diameter: 5/8"

Use with Auveco 8829 E-Type Retaining Ring  
Rear Door Upper Hinge S & T Trucks 1994 - On

UNIT PACKAGE: 1



22174  
(GM: 19332887)

Greaseable Stainless Steel  
Door Hinge Pin and Bushing Repair Kit  
Repairs Two Hinges  
GMC Full Size Pick-Ups & SUV's 1998 - 1988

UNIT PACKAGE: 1



19781  
(15653790)  
Zinc & Yellow

Door Hinge Pin  
Length: 4-1/8"  
Pin Diameter: 11/32"  
Shoulder Outer Diameter: 3/8"  
Head Outer Diameter: 1/2"

Use with Auveco Bushings 16936,  
16937 & Pin Retainer 17976  
S & T Trucks 1994 - On

UNIT PACKAGE: 2

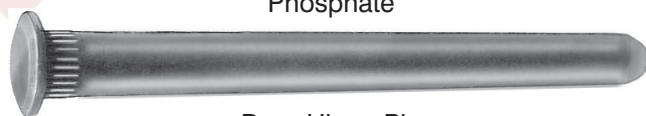

14559  
(GM: 6271989, 20046147)  
Phosphate

Door Hinge Pin  
Length: 4-1/16"  
Pin Diameter: 11/32"  
Head Outer Diameter: 9/16"

**Buick:** Estate Wagon & LeSabre Wagon 90-82,  
Electra 82, Regal 87-82, Riviera 85-82,  
and all exc. Skyhawk 77-76;

**Cadillac:** Cimarron 88-82, Eldorado & Seville 85-82,  
Fleetwood Brougham 92-82;

**Chevrolet:** Camaro 81-78, C & K Trucks 84 - 73  
Monte Carlo, Malibu & El Camino 88-76,  
Impala & Caprice 90-82, Nova 79-77;

**Oldsmobile:** Cutlass Supreme, Calais &  
Cruiser 88-76, Delta 88 90-77, Omega 79-77,  
Toronado 85-82, 98 Recency 82-77;

**Pontiac:** Firebird 81-78, Grand Prix 87-77, LeMans &  
Grand Am 81-77 Phoenix & Ventura 79-77,  
Safari & Parisienne 89-83

UNIT PACKAGE: 10



19725  
(Not Available from O.E.M.)  
Zinc

Door Hinge Roller Pin Assembly  
Diameter: 9/16"  
Length: 5-1/2"  
Roller Outer Diameter: 3/4"  
Roller Groove Diameter: 5/8"  
Knurl Diameter: 19/32"  
GM C & K Light Duty Trucks 2000 - 88

UNIT PACKAGE: 1

# GENERAL MOTORS CLIPS & FASTENERS

**Sec. 20**

*Photos not actual size*

## 19183

(GM: 20043351)  
Phosphate



Door Hinge Pin  
Length: 4"  
Pin Diameter: 11/32"  
Head Outer Diameter: 7/16"

**Buick:** Skyhawk 88-82, Skylark 85-82;  
**Chevrolet:** Cavalier 94-82, Celebrity 90-82,  
Chevette 87-78, and Citation 85-80  
**Oldsmobile:** Cutlass Ciera 95-82,  
Firenza 88-82, Omega 84-80,  
**Pontiac:** Phoenix 84-80, Sunbird 94-82,  
T-1000 87-82 and 6000 91-82

UNIT PACKAGE: 10

## 19424

(15591860; 15691595;  
5967691; 88891731)  
Stainless Steel



Door Hinge Pin  
Length: 5-1/4"  
Pin Diameter: 11/32"  
Shoulder Outer Diameter: 3/8"  
Head Outer Diameter: 9/16"  
GM Trucks

**Use with Auveco Bushings 16936 & 16937  
& Pin Retainer 17976**  
C-K Models 1988-On

UNIT PACKAGE: 4

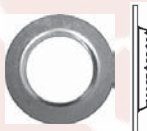

## 17976

(15562610)  
400 Series  
Stainless Steel

*Photo actual size*

Door Hinge Pin Retainer  
Inner Diameter: 21/64"  
Outer Diameter: 9/16"  
Thickness: 1/64"  
**Used with 19424 &  
19781 Door Hinge Pin**  
GM Trucks C-K 1988-On

UNIT PACKAGE: 50

## 17437

(12338015, 14066728)  
Zinc & Yellow



Door Hinge Pin  
Length: 4-5/32"  
Pin Diameter: 11/32"  
Head Outer Diameter: 15/32"  
GM Astro Van, Safari Van & S-10 1982-On

UNIT PACKAGE: 5



## 14548

(9822198)

*Photo actual size*

Inner Diameter: 3/8"  
Outer Diameter: 1/2"  
Height: 15/32"

Flange Outer Diameter: 5/8"  
Buick 1975-42

Chevrolet: Monza & Vega 1980-76,  
All (Exc. Corvette) 1975-62, Olds Starfire 1980-76  
Pontiac: Astre & Sunbird 1980-76 and All 1975-49

UNIT PACKAGE: 25



## 14549

(9716926, 20345137)

*Photo actual size*

Thick Bushing  
Inner Diameter: 11/32"  
Outer Diameter: 1/2"  
Height: 3/8"

Flange Outer Diameter: 19/32"  
Buick 1976-On

Cadillac 1980-On  
Chevrolet: All 1976-On, Corvette 1982-73  
Olds (Exc. Starfire) 1980-On  
Pontiac: Exc. Astre & Sunbird 1980-On

UNIT PACKAGE: 25



## 14550

(GM: 9721917;  
Ford: D1AZ-6522841A)

*Photo actual size*

Inner Diameter: 11/32"  
Outer Diameter: 27/64"  
Height: 19/64"

Flange Outer Diameter: 19/32"  
Buick (Exc. Skyhawk) 1967-On  
Cadillac 1946-On

Chevrolet: Exc. Monza & Vega 1962-On,  
Corvette 1956-On, GM C & K Trucks 1993 - 79  
Olds Exc. Starfire 1949-On  
Pontiac: Exc. Astre & Sunbird 1932-On

UNIT PACKAGE: 25



**14553**

(20429500)

Inner Diameter: 11/32"  
Outer Diameter: 31/64"  
Height: 23/64"  
Flange Outer Diameter: 19/32"  
Splined Outer Diameter  
All GM (Including Pick-Ups & Vans)  
1968-On

UNIT PACKAGE: 25



**16936**

(12338074, 15691493,  
15964971 & 16632193)

Inner Diameter: 11/32"  
Outer Diameter: 1/2"  
Height: 23/64"  
Flange Outer Diameter: 43/64"  
Splined Outer Diameter  
Side Door Upper Hinge  
GM Trucks C-K Models 1988-On

UNIT PACKAGE: 25



**16937**

(15562609, 15964972  
& 16632192)

Inner Diameter: 25/64"  
Outer Diameter: 17/32"  
Height: 23/64"  
Flange Outer Diameter: 11/16"  
Splined Outer Diameter  
Side Door Lower Hinge  
GM Trucks C-K Models 1988-On

UNIT PACKAGE: 25



**12314**

(20037597)

*Photo not actual size*  
Clear Knob  
GM 1952-On

UNIT PACKAGE: 1



**12315**

(1732326)

*Photo not actual size*  
Black Knob  
GM 1952-On

UNIT PACKAGE: 1



**12316**

(458030)

*Photo not actual size*  
GM Trucks 1977-On

UNIT PACKAGE: 1

**TIPS FOR NAVIGATING THE CATALOG**

• **Color Coded Pages**

- Yellow-** New Items
- Blue-** Metric Items
- Brown-** Electric Accessories
- Green-** Assortments, Cabinets, Bins and Racks
- Gray-** Key Blanks & Accessories
- Pink-** Import Car Body Hardware

• **Specification Charts**

- Body Bolts-** Pages: 88 & 121-122
- Special Tapping Screws-** Pages: 91-94 & 128-130
- License Plate Screws-** Pages: 105-106
- Retainers-** Pages: 475-489
- Push-Type Retainers-** Pages: 534-545

• **Indexes. Located in the front**

- Pictorial**
- Alphabetical**
- Numerical**

- Images are actual size unless noted otherwise
- OEM Part Cross Reference: Indexed according to OEM number and Part Number. Located in the back

*Located in the front after the numerical index*

- Screw Identification charts: head styles, driving recesses, point styles and sizing.
- List of common terminology with brief descriptions
- Plating and finish types with brief descriptions



# FORD MOTORS CLIPS & FASTENERS

## Sec. 20

**15968**  
(E6DZ-13032A)



Adjusting Screw Assembly  
Hex & Slotted Drives  
Taurus & Sable 1988-86

UNIT PACKAGE: 10

**15966**  
(E7SZ-13032-D)

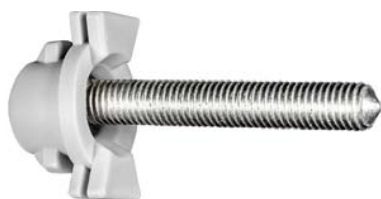

#12 -28 x 1-1/2"  
Adjusting Screw Assembly  
R.H. Upper, L.H. Lower  
Phillips Drive  
T-Bird, Cougar & Continental 1988-87

UNIT PACKAGE: 5



**16399**  
(E9TZ-13032B,  
E97B-13A093BA)  
Black Screw

Bronco & Ranger 1989-On

UNIT PACKAGE: 5

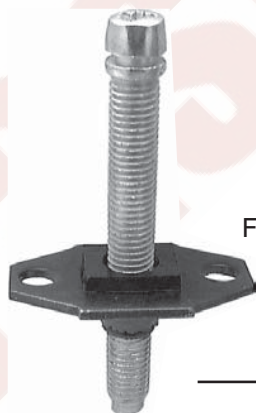

**11660**  
(DOZB-13A-093-AA)  
Zinc Screw & Phosphate Plate

1/4"-28 x 2"  
Headlight Adjusting Screw  
& Nut Assembly  
Ford Cars & Medium Duty Trucks  
1973-On

UNIT PACKAGE: 10

**11661**

Same as 11660 except for unit package quantity

UNIT PACKAGE: 25



**12228**  
(FDA13021-A)  
Zinc-Nylon Nut

Thread: 1/4"-28  
Headlight Adjusting  
Nut Mount  
Ford 1980-On

UNIT PACKAGE: 10



**21185**  
(W710793-S439)  
Zinc Organic

Headlight Mounting Clip  
Thread: M6-1.0  
Ford Super Duty Pick-Up  
2009 - 08

UNIT PACKAGE: 10



**18899**  
(F1CZ-13A147A)  
Black Nylon

Headlight Pivot Socket  
Escort & Tracer  
1991-On

UNIT PACKAGE: 25



**15940**  
(E9DB-13N020AA,  
E9DZ-13N129A)

Headlight Component  
Pivot Retaining Clip  
Ford Taurus & T-Bird and  
Mercury Cougar & Sable  
1989-On

UNIT PACKAGE: 25



**18263**  
(F37Z-13N129-A)  
Black

Headlight Component  
Retaining Clip  
Mustang & Ranger 1993-On

UNIT PACKAGE: 25

**Sec. 20**

**FORD MOTORS CLIPS & FASTENERS**



**18155**  
(N803768-S)  
Natural Nylon

Door Arm Rest Nut  
Screw Size: #8  
Mustang & Capri 1987-On

UNIT PACKAGE: 15



**10305**  
White Nylon

Nylon Nut  
Screw Size: #8

UNIT PACKAGE: 50



**9862**  
(379830-S)  
White Nylon

Headlight Door, Grille & Mirror Nut  
Screw Size: #8 or #10  
Fits into 1/4" Square Hole  
Ford

UNIT PACKAGE: 50



**14755**  
(379830-S)  
White Nylon

Screw Size: #8  
Width: 3/8"  
Length: 3/8"  
Fits into 1/4" Square Hole  
Ford 1986-On

UNIT PACKAGE: 25



**14756**  
(Ford: 379830-S; Chry: 6033677)  
Black Nylon

Screw Size: #8  
Width: 3/8"  
Length: 3/8"  
Fits into 9/32" x 9/32" Hole  
Panel Thickness: 1/4"  
Ford & Chrysler 1986-On

UNIT PACKAGE: 25



**20245**  
(N806334-S,  
W707157-S300)  
Natural Nylon

Nylon Nut  
Screw Size: M4.2 (#8)  
Head Size: 10mm x 10mm  
Fits into 6mm Square Hole  
Ford 1999 - On

UNIT PACKAGE: 50



**18383**  
(W700566-S300)  
Natural Nylon

Screw Size: #12  
Back Panel Attachment  
Contour & Mystique 1995-On

UNIT PACKAGE: 25



**11865**  
(GM: 1255823; Ford: 389360S)  
Natural Nylon

Tail Light Nut  
Screw Size: #6 or #8  
Ford 1981-On  
Front End Bezel Nut  
GM 1979-On

UNIT PACKAGE: 50



**12569**

(Ford: N801706-S; Chry: 6501773)  
Black Nylon

Screw Size: #12  
Ford 1981-On

UNIT PACKAGE: 25



**14754**

(N802376-S)  
Blue Nylon

Screw Size: #8  
Width: 3/8"  
Length: 1/4"  
Panel Thickness: 5/32"  
Fits into 1/4" Square Hole  
Ford

UNIT PACKAGE: 25



**20927**

(N811478-S100)  
Black Nylon

License Plate & Rear Bumper  
Nylon Nut with Sealer  
Screw Size: M6.3 (#14)  
Head Size: 16mm x 16mm  
Stem Length: 8mm  
Fusion & Mustang 2005 - On

UNIT PACKAGE: 15



**21368**

(W711079-S300)  
Black Nylon

Tail Light Grommet  
Head Size: 13mm x 17mm  
Stem Length: 10mm  
Explorer, Mountaineer & Pick-Up Trucks  
2006 - On

UNIT PACKAGE: 25

# FORD MOTORS CLIPS & FASTENERS

## Sec. 20



**19277**  
(N804765-S)  
Natural Nylon

Wheel Opening Screw Grommet  
Screw Size: #8 (M4.2)  
Head Size: 3/8" x 3/8"  
Stem Length: 7/8"  
Mustang, T-Bird, Cougar &  
Continental 1993-On

UNIT PACKAGE: 50



**20425**  
(F5RZ-17K657-A)  
Natural Nylon

Windshield Washer Reservoir  
Mounting Screw Grommet  
Screw Size: #12  
Head Diameter: 1/2"  
Overall Length: 13/16"  
Fits into 3/8" Sq. Hole  
Ford Contour, Focus & Mystique 1995 - On

UNIT PACKAGE: 25



**21362**  
(W708580-S300)  
Black Nylon

Side Marker Tail Light &  
Bumper Screw Grommet  
Screw Size: M4.2 (#8)  
Head Size: 11.5mm x 11.5mm  
Stem Length: 18mm  
Expedition, Fusion, Milan, MKZ &  
Navigator 2006 - On

UNIT PACKAGE: 25



**19326**  
(N807706-S)  
Natural Nylon

Front Bumper Fascia Grommet  
Escort, Explorer & Mustang 1996-On

UNIT PACKAGE: 25



**21239**  
(W708319-S300)  
White Nylon

Front Bumper Screw  
Grommet with Sealer  
Screw Size: M4.8 (#10)  
Head Diameter: 16mm  
Stem Length: 24mm  
Fusion 2009 - On

UNIT PACKAGE: 25



**21826**  
(Ford: W711031-S300)  
Black Nylon

License Plate & Tail Light  
Screw Grommet with Sealer  
Screw Size: M6.3 - 1.81 (#14)  
Head Size: 15mm x 15mm  
Stem Length: 22mm  
Ford Edge, Explorer, Fiesta,  
Flex, Focus, Fusion & Lincoln 2014 - 06

UNIT PACKAGE: 15



**20532**  
(W708045-S300)  
Black Rubber

Rear Bumper Cover Grommet  
Head Diameter: 15mm  
Stem Length: 21mm  
Fits into 9.5mm Hole  
**Use with Auveco 20531**  
Ford Expedition 2003 - On

UNIT PACKAGE: 25



**20393**  
(W706575-S300)  
Natural Nylon

Door Panel Screw Grommet  
Screw Size: M4.2 (#8)  
Stem Length: 20mm  
Fits into 10mm Square Hole  
Ford Escape 2001 - On

UNIT PACKAGE: 50



**11841**  
(N-800503S)  
Black Nylon

Grille Attachment Nut  
Screw Size: #6  
Ford 1978-On

UNIT PACKAGE: 50

**Sec. 20**

**FORD MOTORS CLIPS & FASTENERS**



**21165**

(W712160-S300)  
Black Nylon

Headlight Grommet  
Screw Size: M6 (#14, 1/4")  
Head Size: 22mm x 23.5mm  
Overall Height: 18mm  
Expedition, F150 and  
Navigator 2003 - On

UNIT PACKAGE: 15



**20264**

(N806363-S)  
White Nylon

Kick Panel Grommet  
Head Diameter: 23mm  
Overall Length: 24mm  
**Used with Auveco Retainer 19760**  
Ford Ranger 1993-On

UNIT PACKAGE: 25



**20466**

(GM: 25649667;  
Ford: W705590-S300,  
W710549-S300)  
Natural Nylon

Screw Grommet  
With Sealer  
Screw Size: M4.2 (#8)  
Head Size: 13mm x 22mm  
Stem Length: 18mm  
Back Glass Moulding & Interior Trim  
Cadillac & Ford Windstar 1998 - On

UNIT PACKAGE: 15



**21304**

(Ford: 3M8Z-16K262-A;  
Mazda: GJ6A-50-ES1)  
Black Nylon

Rear Bumper Grommet with Sealer  
Head Size: 27mm x 30mm  
Stem Length: 32mm  
Fits into 17mm x 20mm Hole  
Ford Fusion, Milan, MKS, MKZ  
& Zephyr and Mazda 6 2003 - On

UNIT PACKAGE: 5



**17317**

(F1CZ-8A188-A)  
Black Nylon

Radiator Grille Spacer  
Ford Escort &  
Mercury Tracer 1991-On

UNIT PACKAGE: 25



**21300**

(Ford: 3M8Z-17C432-A;  
Mazda: GK2A-50-798)  
White Nylon

Cowl Vent Screw  
Grommet with Sealer  
Screw Size: M4.8 (#10)  
Head Size: 15mm x 27mm  
Stem Length: 13mm  
Fusion, Milan, MKZ & Zephyr  
and Mazda 6 2003 - On

UNIT PACKAGE: 5



**20530**

(Not Available from O.E.M.)  
Black Nylon

Radiator Shroud  
Air Deflector Retainer  
Head Diameter: 20mm  
Stem Diameter: 13mm  
Stem Length: 16mm  
Ford Expedition 2003 - On

UNIT PACKAGE: 50



**21224**

(Ford: F50Y-14603-A)  
Black Nylon

Headlight and  
Tail Light Grommet  
Head Size: 18.5mm x 21.5mm  
Stem Length: 18mm  
Fits into 9.5mm x 21.5mm Hole  
Explorer, Navigator and  
Super Duty Pick-Up 2003 - On

UNIT PACKAGE: 25



**17195**

(Isuzu: 8942180270)  
Black Nylon

Grille Clip  
Width: 13mm  
Length: 22mm  
Ford Escort, Honda, Isuzu,  
Mitsubishi & Plymouth Laser

UNIT PACKAGE: 25

# FORD MOTORS CLIPS & FASTENERS



**20171**  
(N807189-S100, N811353-S100)  
White Nylon

Cowl Vent Grommet  
Screw Size: M4.2 (#8)  
Fits into 10mm x 14mm Hole  
F150 Pickup, Expedition  
& Windstar 1995 - On

UNIT PACKAGE: 10



**19138**  
(Ford: F1CZ-5802316A;  
Mazda: BW0A-50-792)  
Black Nylon

Cowl Top Vent Grille Retainer  
Ford Escort & Tracer and  
Mazda 1991-On

UNIT PACKAGE: 15



**19238**  
(F6DZ-5402316-AA)  
Natural Nylon

Cowl Top Vent Grille Grommet  
**Use with Auveco 19237**  
Ford Taurus & Sable 1996-On



UNIT PACKAGE: 50



**19237**  
(W701649-S, W704881-S300)  
Black Nylon

#10 x 1-1/32"  
Cowl Top Vent Grille Nylon Screw  
Head Outer Diameter: 9/16"  
**Use with Auveco 19238**  
Ford Taurus & Sable 1996-On

UNIT PACKAGE: 50



**17551**  
(Mazda: GJ21-50-H81)  
Natural Nylon

Cowl Screen Grommet  
Ford Probe and  
Mazda 626 & MX6 1988-On

UNIT PACKAGE: 25



**17552**  
(Mazda: GJ21-50-H82)  
Natural Nylon

Cowl Screen Grommet  
Ford Probe and  
Mazda 626 & MX6 1988-On

UNIT PACKAGE: 25



**17553**  
(Mazda: KA01-50-H16)  
Yellow Nylon

Rear Hatch Grommet  
**Use with Auveco 17554**  
Ford Probe and Mazda MX 6 1988-On

UNIT PACKAGE: 25



**17554**  
(Mazda: KA01-50-H15A)  
Black Nylon

Rear Hatch Retainer  
**Use with Auveco 17553**  
Ford Probe and Mazda MX6 1988-On

UNIT PACKAGE: 25



**18816**  
(N807994-S)  
Black Nylon

Grille & Side Marker Light Grommet  
Fits into 10mm Hole  
Ford 1994-On

UNIT PACKAGE: 50



**17667**  
Green Nylon

Tubular Nut  
Hole Size: 3/8"  
Lower Body Side Moulding  
Lincoln Town Car 1990-On

UNIT PACKAGE: 25



**19526**  
(N807247-S)  
Natural Nylon

Rear Door & Back Window  
Trim Panel Grommet  
Screw Size: #12 - 24  
Fits into 1/2" Hole  
Lincoln Town Car 1990 - On

UNIT PACKAGE: 25



**19783**  
(N811169S, W705550-S300)  
White Nylon

Park & Turn Signal Housing Grommet  
Stud Size: 7/32"  
Head Diameter: 13mm  
Stem Length: 9mm  
Fits into 11mm Hole  
F250 - F550 Trucks 1999 - On

UNIT PACKAGE: 50

**Sec. 20**

**FORD MOTORS CLIPS & FASTENERS**



**22359**

(Ford: W702438-S300)  
Black Nylon

Radiator Grille Screw Grommet  
Screw Size: M4.8 (#10)  
Head Diameter: 20mm  
Stem Length: 11mm  
Fits into 11.5mm x 7.5mm Slot  
Ford C-Max, Escape, Fiesta, Focus,  
Fusion, Transit Connect and Lincoln  
MKC & MKZ 2015 - 2010

UNIT PACKAGE: 25



**21507**

(Not Available from O.E.M.)  
White Nylon

Belt Moulding Clip  
Width: 25mm  
Length: 36mm  
Overall Height: 27mm  
Edge 2009 - On

UNIT PACKAGE: 15

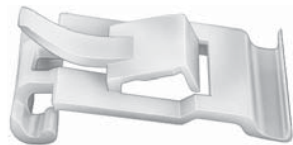

**19752**

(Not Available from O.E.M.)  
White Nylon

Door Belt Moulding Clip  
Taurus, Sable Contour &  
Mystique 1998 - 95

UNIT PACKAGE: 15



**18377**

(W701430-S300)  
Black Nylon

Door Trim Retaining Clip  
Contour & Mystique 1995-On

UNIT PACKAGE: 10



**20400**

(YF4Z-8194-AA)  
Nylon

Radiator Grille Clip  
Width: 11/32"  
Length: 1-9/32"  
Mercury Sable 2000 - On

UNIT PACKAGE: 15



**21790**

(Ford: W709688-S300)  
Black Nylon

Hood Insulation Retainer  
Head Size: 28mm x 30mm  
Stem Length: 14mm  
Overall Height: 16mm  
Ford Focus & Lincoln MKZ  
2012 - On

UNIT PACKAGE: 25



**19154**

(E2EB-61290C62-AA)  
Nylon

Body Side  
Moulding Clip  
Escort & Lynx 1981-On

UNIT PACKAGE: 25



**20862**

(4L3Z-1510182-AA)  
Black Nylon

Roof Garnish Moulding Clip  
Tip to Tip: 42mm  
Front to Back: 12mm  
Height: 21mm  
Ford F-150 2005 - On

UNIT PACKAGE: 15



**17451**

(Mazda: H001-68-719B)  
Nylon

Rocker Scuff  
Plate Retainer  
Ford Probe and Mazda MX6 1988-On

UNIT PACKAGE: 25



**21306**

(Not Available from O.E.M.)  
White Nylon

Belt Moulding Clip  
Width: 18mm  
Length: 37mm  
Taurus 2010 - On

UNIT PACKAGE: 10



**21506**

(Not Available from O.E.M.)  
Black & White Nylon

Windshield Moulding Clip with Sealer  
Top Head Size: 13mm x 13.5mm  
Bottom Head Size: 12mm x 14mm  
Stem Length: 9mm  
Explorer 2011 - On

UNIT PACKAGE: 10