

RIVETS

Auveco Klamp-Tite Rivets

- Largest Blind Head
 - Fills hole tightly
 - High Clamp-Up
- Water Tight Capability
 - Fully Cored
- Structural- Self Plugging
- Head Style- Protruding

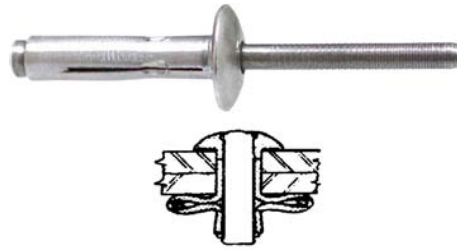

Mandrel breaks flush with top of rivet head anywhere within grip range.

Material: Rivet 5056 Aluminum, Mandrel 7075 Aluminum
Finish: Wax (Do Not Remove)

Note: For use with pneumatic tool using 13808 (3/16") nose piece on page 296.

Auveco Part No.	Unit Pkg.	Rivet Diameter	Grip Range	Hole & Drill Size	Mandrel Diameter	Head Diameter	Head Thickness	Rivet Length Max
13766	50	3/16	3/64" - 1/4"	.204-.209 (#5)	.103	.445	.088	.890
13767			3/16" - 3/8"					.985
13768			3/8" - 9/16"					1.045
13769	25	1/4	3/64" - 1/4"	.252-.262 (F)	.136	.560	.113	.920
13770			3/16" - 3/8"					1.045

Blind Tacking Rivets

- Steel Rivet: Plated
- Non-Structural: Break mandrel rivets
 - Steel Mandrel: Coated
- Conform to IFI-114 Standards

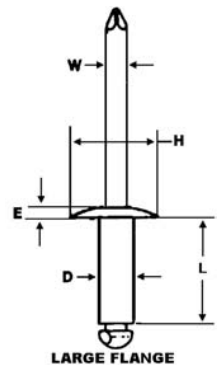
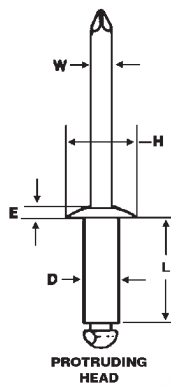

Nom. Rivet Diameter	Hole Size & Drill Number	W Mandrel Diameter	D Rivet Diameter	Protruding Head		Large Flange Head	
				H Head Diameter	E Max.	H Head Diameter	E Max.
1/4"	.257-.261 (F)	.151	.250	.500	.080	.750	.107

Auveco Part No.	Head Style	Rivet Diameter	Grip	Rivet Length L	Unit Pkg.
13796	Large Flange	1/4"	1/2" - 5/8"	13/16"	25

Large Secondary Head Rivets



Rivets that fasten securely into thick and thin materials. Will pull soft or brittle materials. Can be used in an oversized hole.

Auveco Part No.	Head (Flange) Type & Diameter	Rivet Diameter	Grip Range	Rivet Length Excluding Flange	Unit Pkg.
Aluminum Rivet & Mandrel					
17471*	Dome 5/16"	1/8"	5/64"-3/8"	31/32"	25
19062	Dome 5/16"	5/32"	0-1/4"	23/32"	25

* Not a Split Type

Sec. 14

RIVETS

Monobolt® Fastening System

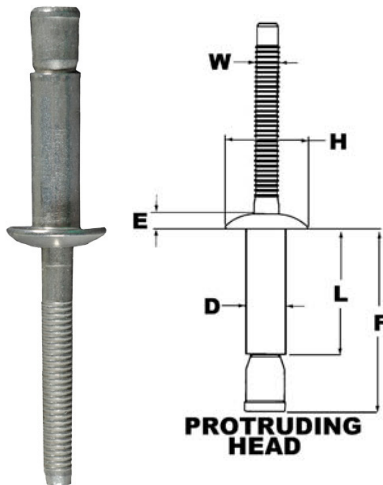

Nom. Rivet Diameter	Hole Size & Drill Number	W Mandrel Diameter	D Rivet Diameter	Protruding Head	
				H Head Diameter	E Head Max.
3/16	.191-.201 (#11)	.118	.187	.390	.070
1/4	.261-.272(G)	.157	.257	.515	.100

Typical Rivet Shear and Tensile Strength (lbs) and Mandrel push-out when installed in Nominal Grip.

Rivet Diameter	Aluminum Rivet & Mandrel			Steel Rivet & Mandrel		
	Shear	Tensile	Mandrel Push-out	Shear	Tensile	Mandrel Push-out
3/16	625	500	50	1300	1000	100
1/4	1300	890	100	2400	2150	250

Auveco Part No.	Diameter	Grip	DIM "L"	DIM "F"	Head Style	Material	Unit Pkg.
12080	3/16"	.062/.270	.406	.748	Protruding	Steel-Zinc Plated	25
12088	3/16"	.062/.270	.406	.748	Protruding	Steel-Zinc Plated	100
12081	3/16"	.214/.420	.531	.882	Protruding	Steel-Zinc Plated	25
12089	3/16"	.214/.420	.531	.882	Protruding	Steel-Zinc Plated	100
12084	1/4"	.080/.375	.550	.971	Protruding	Steel-Zinc Plated	25
12092	1/4"	.080/.375	.550	.971	Protruding	Steel-Zinc Plated	100
12085	1/4"	.350/.625	.855	1.123	Protruding	Steel-Zinc Plated	25
12093	1/4"	.350/.625	.855	1.123	Protruding	Steel-Zinc Plated	100
12086	1/4"	.080/.375	.550	.961	Protruding	Aluminum	25
12094	1/4"	.080/.375	.550	.961	Protruding	Aluminum	100
13773	1/4"	.350/.625	.810	1.174	Protruding	Aluminum	25
13774	1/4"	.350/.625	.810	1.174	Protruding	Aluminum	100

The System

Blind Installation: The single side installation feature of the Auveco Monobolt System allows one operator to produce high quality structural joints in seconds. Use of the Monobolt power tool does not require special skill or training, because the tool completely controls the installation cycle.

Multi-Grip: One size Monobolt fastener will function effectively in a wide range of material thicknesses (Example: .080" to .375"). This versatility decreases the potential for production errors and reduces fastener inventory requirements.

Uniform Clamping Action: Monobolt fasteners are engineered to draw materials together by developing positive clamping action.



Its Advantages

Structural Fastening: An installed Monobolt fastener yields high shear and tensile values. Conventional fasteners can be replaced by Monobolt without compromising structural requirements.

Positive Stem Retention: At the completion of the installation cycle, the stem is mechanically locked into the Monobolt shell, creating a vibration-proof joint of assured structural quality.

Flush Break Stem: Within the specific grip range for each size, Monobolt fastener, the stem is designed to break flush with the low profile head. Secondary finishing operations, such as grinding or milling, are not necessary to achieve good product appearance.

Complete Hole Fill: During installation, the Monobolt shell expands into 360° contact with the walls of the parent material. This feature, in conjunction with positive stem retention, produces weather resistant joints.

Quiet, Safe Installation: The Monobolt System, operating at 85db ("A" Weighted), complies with OSHA regulation governing plant noise levels and operator safety

How it Works



1. The Monobolt fastener is loaded into the nose of the placing tool and inserted in a prepared hole. As the tool is actuated, the pulling jaws grip the Monobolt stem.



2. An axial pull draws the stem through the shell, expanding it radially. During this phase, the hole is completely filled and work pieces are drawn together.



3. When the stem reaches a pre-determined position within the Monobolt shell, it separates flush with the head profile regardless of work piece thickness. Simultaneously, the stem section remaining in the shell is mechanically locked in place by the Monobolt tool.

RIVETS

Interlock® Dome Head High Strength Rivets



High strength Interlock® rivets feature a positive mechanical locking system that provides superior holding power. This system also guarantees 100% mandrel retention that's visually verifiable. Can be set with Auveco Rivet Gun 11817.

Auveco Part No.	Rivet Diameter	Grip Range	Rivet Body Length	Head Diameter	Unit Pkg.	Conversion				
						Interlock®	Cherry Monobolt	Avdel Monobolt	Huck Magna-lock	
Aluminum Rivet & Mandrel										
17421	3/16"	1/16" - 17/64"	13/32"	3/8"	25	AD6270UG	BAPV-64	2774-0613	MGLP-B6-4	
17422	3/16"	1/16" - 7/16"	9/16"	3/8"	25	AD6437UGX		2774-0617	MGLP-B6-E	
17423	1/4"	5/64" - 3/8"	9/16"	1/2"	25	AD8375UG	BAPV-86	2774-0817	MGLP-B8-6	
17424	1/4"	5/64" - 5/8"	13/16"	1/2"	15	AD8625UGX		2774-0824	MGLP-B8-E	
Steel Rivet & Mandrel										
17425	3/16"	1/16" - 17/64"	13/32"	3/8"	25	SD6270UG	SSPV-64	2771-0613	MGLP-R6-4	
17427	1/4"	5/64" - 3/8"	9/16"	1/2"	25	SD8375UG	SSPV-86	2771-0817	MGLP-R8-6	
17428	1/4"	5/64" - 5/8"	13/16"	1/2"	15	SD8625UGX		2771-0824	MGLP-R8-E	
Stainless Steel Rivet & Mandrel										
17429	3/16"	1/16" - 17/64"	13/32"	3/8"	10	SSD6270UG	CCPV64	2711-0613	MGLP-U6-4	



Closed - End Rivets

Can be set with Auveco Rivet Gun 7915

Auveco Part No.	Head (Flange) Type	Head Diameter	Rivet Diameter	Grip Range	Rivet Length Excluding Flange	Unit Pkg.
Black Aluminum Rivet & Mandrel						
17408	Dome	15/64"	1/8"	13/64" - 9/32"	15/32"	50
17410	Dome	3/8"	3/16"	3/8" - 1/2"	11/16"	25
Aluminum Rivet & Mandrel						
17419	Dome	3/8"	3/16"	1/16" - 1/8"	11/32"	50
17420	Dome	3/8"	3/16"	1/8" - 1/4"	15/32"	50
Aluminum Rivet & Steel Mandrel						
17411	Dome	15/64"	1/8"	1/16" - 1/8"	5/16"	50
19065	Countersunk	5/16"	5/32"	1/8" - 3/16"	13/32"	100
17415	Dome	3/8"	3/16"	1/8" - 1/4"	15/32"	50
17416	Dome	3/8"	3/16"	1/4" - 3/8"	19/32"	50

“PEEL - TYPE” SPECIALTY RIVETS

Use 11817 Rivet Gun with 11853 Nose Piece (Page 295) to set all 1/4" "Peel-Type" Rivets



19414
(W525170-S417)

“Peel-Type” Rivet
Diameter: 3/16"
Grip: 1/32"-1/4"
Flange Diameter: 1/2"
Aluminum Rivet (Black) & Steel Mandrel (Zinc)
Side Door Lock Attachment
Mercury Villager 1995 - On

UNIT PACKAGE: 25



11620

(GM: 9436175;
Ford: 385189-S100;
Chry: 6031115)

“Peel-Type” Rivet
Diameter: 1/4"
Grip: 1/32" - 9/64"
Flange Diameter: 1/2"
Aluminum Rivet & Steel Mandrel
Window Regulators
GM, Ford & Chrysler 1971 - On

UNIT PACKAGE: 25

16837

Same as 11620 except for unit package quantity

UNIT PACKAGE: 50

Sec. 14

“PEEL - TYPE” SPECIALTY RIVETS

Use 11817 Rivet Gun with 11853 Nose Piece
(Page 295) to set all 1/4” “Peel-Type” Rivets



19110
(W525172-S)

“Peel-Type” Rivet
Diameter: 1/4”
Grip: 1/32”-7/32”
Flange Diameter: 1/2”
Aluminum Rivet & Steel Mandrel (Zinc)
Glass, Regulator Assembly
& Remote Latch Assembly
Ford Mustang & Lincoln Continental 1994 - On

UNIT PACKAGE: 25



15684
(20713843)

“Peel-Type” Rivet
Diameter: 1/4”
Grip: 7/64” - 11/64”
Flange Diameter: 1/2”
Recess under Head
Aluminum Rivet & Steel Mandrel
Used on Window Regulators
& Door Lock Assemblies
GM A & J Cars

UNIT PACKAGE: 25



19461
(W525172-S417)

“Peel-Type” Rivet
Diameter: 1/4”
Grip: 1/32”-7/32”
Flange Diameter: 1/2”
Aluminum Rivet (Black) & Steel Mandrel (Zinc)
Outside Door Handle
Ford Crown Victoria, Econoline, Explorer,
Grand Marquis, Ranger, Sable,
Taurus & Windstar 1995 - On

UNIT PACKAGE: 15



12655
(GM: 9437486;
Chry: 6032926)

“Peel-Type” Rivet
Diameter: 1/4”
Grip: 9/64” - 3/16”
Flange Diameter: 1/2”
Aluminum Rivet & Steel Mandrel
Window Regulators
GM 1981 - On

UNIT PACKAGE: 25



11852
(Ford: 388047-S100;
GM: 14078435)

“Peel-Type” Rivet
Diameter: 1/4”
Grip: 5/64” - 7/64”
Flange Diameter: 1/2”
Recess under Head
Aluminum Rivet & Steel Mandrel
Attaches Outside Door Handle
Ford 1978 - On
Heat Shield Attachment
GM

UNIT PACKAGE: 25



14486
(GM: 9437486;
Chry: 6032926)

“Peel-Type” Rivet
Diameter: 1/4”
Grip: 9/64” - 3/16”
Flange Diameter: 1/2”
Aluminum Rivet & Steel Mandrel
Used on Window Regulators,
Quarter Vent Handle Assemblies &
Electrical Door Lock Linkage
GM & Chrysler 1981 - On

UNIT PACKAGE: 25



12653
(388047-S102)

“Peel-Type” Rivet
Diameter: 1/4”
Grip: 3/32”-1/8”
Flange Diameter: 1/2”
Aluminum Rivet (Black) & Steel Mandrel
Door Handle Assembly
Ford 1981 - On

UNIT PACKAGE: 25



20402
(9437643)

“Peel-Type” Rivet
Diameter : 1/4”
Grip: 3/16” - 1/4”
Flange Diameter: 1/2”
Aluminum Rivet & Steel Mandrel (Zinc)
Window Regulator
Saturn 1993 - On

UNIT PACKAGE: 25

“PEEL - TYPE” SPECIALTY RIVETS

Use 11817 Rivet Gun with 11853 Nose Piece
(Page 295) to set all 1/4” “Peel-Type” Rivets

11621

(Ford: 385323-S100; Chry: 6031091; GM: 9437938)



“Peel-Type” Rivet
Diameter: 1/4”
Grip: 33/64” - 19/32”
Flange Diameter: 1/2”
Aluminum Rivet & Steel Mandrel
Window Regulator
GM, Ford & Chrysler 1976 - On

UNIT PACKAGE: 10

16838

Same as 11621 except for unit package quantity

UNIT PACKAGE: 25

12658

(GM: 12338153, 20184399; Ford: 389268-S100)



“Peel-Type” Rivet
Diameter: 1/4”
Grip: 11/16” - 3/4”
Flange Diameter: 1/2”
Aluminum Rivet & Steel Mandrel
Window Regulator
GM & Ford 1979 - On

UNIT PACKAGE: 25

18396

(N808594-S100)
Zinc & Yellow



“Peel-Type” Rivet
Diameter: 1/4”
Grip: 1/8”-5/16”
Flange Diameter: 5/8”
Aluminum Rivet & Steel Mandrel
Door Lock Actuator
Ford

UNIT PACKAGE: 25

19420

(W525174S)



“Peel-Type” Rivet
Diameter : 1/4”
Grip: 13/64”-13/32”
Flange Diameter: 5/8”
Aluminum Rivet & Steel Mandrel (Zinc)
Door Handle
Ford Ranger 1997 - On

UNIT PACKAGE: 25

19456

(W525175-S)



“Peel-Type” Rivet
Diameter: 1/4”
Grip: 25/64” - 21/32”
Flange Diameter: 5/8”
Aluminum Rivet & Steel Mandrel (Zinc)
Front Door Window
Ford Continental, Crown Victoria, Explorer, Grand
Marquis, Mark VIII, Mustang, Ranger, Sable, Taurus,
Town Car & Windstar 1996 - On

UNIT PACKAGE: 15

18167

(Ford: N804193-S100;
GM: 9441592, 15672713)

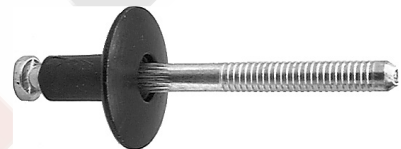

“Peel-Type” Rivet
Diameter: 1/4”
Grip: 3/32”-9/64”
Flange Diameter: 3/4”
Aluminum Rivet (Black) & Steel Mandrel
Front Door Handle & Door Lock Actuator
Tempo, Topaz, T-Bird & Cougar 1984 - On
Rocker Panel Moulding
Chevrolet Beretta & Corsica 1996 - 92

UNIT PACKAGE: 25

19458

(N808689-S417)



“Peel-Type” Rivet
Diameter: 1/4”
Grip: 1/8”-21/64”
Flange Diameter: 3/4”
Aluminum Rivet (Black) & Aluminum Mandrel
Door Lock Actuator
Ford Continental, Crown Victoria,
F Series Truck, Grand Marquis, Mark VII, Mustang,
Ranger, Sable, Taurus, Town Car & Windstar 1995 - On

UNIT PACKAGE: 10

Sec. 14

SPECIALTY RIVETS



10658

Diameter: 3/32"
Grip: 1/8"-1/4"
Flange Diameter: 3/16"
Aluminum Rivet & Mandrel

Replaces welded studs on body panels.

UNIT PACKAGE: 100



18499

Diameter: 1/8"
Grip: 1/8"-3/16"
Flange Diameter: 3/16"
Aluminum Rivet & Mandrel
Trim Moulding Attachment

UNIT PACKAGE: 100



18500

Diameter: 1/8"
Grip: 3/16"-1/4"
Flange Diameter: 3/16"
Aluminum Rivet & Mandrel
Trim Moulding Attachment

UNIT PACKAGE: 100



11104

(Ford: 383229-S)

Diameter: 1/8"
Grip: 3/16"-1/4"
Flange Diameter: 3/16"

Stainless Steel Rivet & Steel Mandrel

Replaces welded studs on body panels.

Use Auveco Rivet Gun 7915 & Nose Piece 7981

UNIT PACKAGE: 100

11105

Same as 11104 except for unit package quantity

UNIT PACKAGE: 500

11106

Same as 11104 except for unit package quantity

UNIT PACKAGE: 1000



7981

Rivet Gun Nose Piece
**Used to set Auveco Rivet 11104
with Rivet Gun 7915**

UNIT PACKAGE: 1



20788

(90269-04051,
90269-A0006)

Diameter: 1/8" (3.2mm)
Grip: 3/64" - 1/8" (1.2mm - 3.4mm)
Flange Diameter: 15/64" (6mm)
Aluminum Rivet with Plastic Cap
Steel Mandrel

Lexus 1998 - On

UNIT PACKAGE: 10



17408

(N803933-S101)

Diameter: 1/8"
Grip: 13/64"-9/32"
Flange Diameter: 15/64"
Closed End
Black Aluminum Rivet & Mandrel
Luggage Rack
Ford

UNIT PACKAGE: 50



17469

(375936-S)

Diameter: 1/8"
Grip: 1/32"-1/8"
Flange Diameter: 1/4"
Stainless Steel Rivet & Mandrel
Attaches Body Side Mouldings
Sets flush, does not leave a raised stud

UNIT PACKAGE: 100



21418

(6508540-AA)

Diameter: 1/8"
Grip: 1/32" - 3/16"
Flange Diameter: 1/4"
Black Aluminum Rivet & Steel Mandrel (Zinc)
Chrysler General Purpose

UNIT PACKAGE: 25



18303

Diameter: 1/8"
Grip: 1/16"-1/8"
Flange Diameter: 1/4"
Aluminum Rivet (Black) & Aluminum Mandrel
Attachment of Rear Window Trim Moulding
Ford Explorer 1990-On

UNIT PACKAGE: 50



17470

(378527)

Diameter: 1/8"
Grip: 1/8"-3/16"
Flange Diameter: 1/4"
Aluminum Rivet & Mandrel
Attaches Climate Controls
Ford

UNIT PACKAGE: 50



17467

(375203S)

Diameter: 1/8"
Grip: 1/8"-3/16"
Flange Diameter: 1/4"
Stainless Steel Rivet & Steel Mandrel
Attaches Body Side Moulding Retainer
Sets flush, does not leave a raised stud
Ford

UNIT PACKAGE: 100

SPECIALTY RIVETS

Sec. 14



21114
(11610210)

Diameter: 1/8"
Grip: 5/32" - 5/16"
Flange Diameter: 1/4"
Aluminum Rivet & Mandrel
Rear Bumper Fascia
Chevrolet Equinox 2005 - On

UNIT PACKAGE: 50



19406
(6035414)

Diameter: 1/8"
Grip: 1/16" - 1/4"
Flange Diameter: 5/16"
Aluminum Rivet & Steel Mandrel (Zinc)
Cladding to Fender Attachment
Chrysler Concorde, Eagle & Intrepid
1997 - On

UNIT PACKAGE: 50



19202

Diameter: 1/8"
Grip: 3/16" - 1/4"
Flange Diameter: 1/4"
Aluminum Rivet (Black) & Aluminum Mandrel
GM & General Purpose

UNIT PACKAGE: 100



12656
(20325696)

Diameter: 1/8"
Grip: 1/8" - 3/16"
Flange Diameter: 5/16"
Aluminum Rivet & Steel Mandrel
Rear Window Gasket Attachment
GM 1981 - On

UNIT PACKAGE: 50



19657
(6034848)
Zinc & Yellow

Diameter: 1/8"
Grip: 1/32" - 3/16"
Flange Diameter: 5/16"
Aluminum Rivet & Steel Mandrel
Rocker Panel & Cladding
Chrysler LH Series 1993 - On

UNIT PACKAGE: 50



20628
(90269-04050)

Diameter: 1/8" (3.2mm)
Grip: 5/32" - 5/16" (4mm - 8mm)
Flange Diameter: 5/16" (8mm)
Aluminum Rivet with Plastic Cap
Steel Mandrel
Windshield, Side & Trunk Moulding
Lexus GS300, 400, 430 & SC430
1998 - On

UNIT PACKAGE: 15



20787
(90269-04006)

Diameter: 1/8" (3.2mm)
Grip: 3/64" - 5/32" (1.2mm - 4.0mm)
Flange Diameter: 5/16" (8mm)
Aluminum Rivet with Plastic Cap
Steel Mandrel
Lexus 1998 - On

UNIT PACKAGE: 10



17615
(6032856)

Diameter: 1/8"
Grip: 3/16" - 3/8"
Flange Diameter: 5/16"
Aluminum Rivet (Black) & Steel Mandrel
Body Side Moulding
& Universal Applications
Chrysler

UNIT PACKAGE: 50



20627
(90269-04053)

Diameter: 1/8" (3.2mm)
Grip: 3/64" - 3/16" (1mm - 4.8mm)
Flange Diameter: 5/16" (8mm)
Aluminum Rivet (Black) with Plastic Cap
Steel Mandrel (Black)
Mouldings
Toyota Land Cruiser 1998 - On

UNIT PACKAGE: 10



18304

Diameter: 1/8"
Grip: 1/16" - 1/8"
Flange Diameter: 3/8"
Aluminum Rivet (Black) & Steel Mandrel
Attachment of Door Glass Moulding
Ford 1993 - On

UNIT PACKAGE: 50

Sec. 14

SPECIALTY RIVETS



21320
(90269-03064)

Diameter: 3.2mm (1/8")
Grip: 1.6mm-3.2mm (1/16"-1/8")
Flange Diameter: 9.5mm (3/8")
Aluminum Rivet & Mandrel
Black Flange
Rocker Moulding
Lexus ES 300 & Others 2002 - On

UNIT PACKAGE: 15



16834
(N805759-S100)

Diameter: 1/8"
Grip: 1/8"-3/16"
Flange Diameter: 3/8"
Aluminum Rivet (Black) & Aluminum Mandrel
Windshield Side Rail
Ford T-Bird & Mercury Cougar 1989-On

UNIT PACKAGE: 50



16686
(9432552)

Multi-Purpose Rivet
Diameter: 1/8"
Grip: 1/8" - 3/16"
Flange Diameter: 3/8"
Aluminum Rivet & Steel Mandrel
Large Flange
GM 1978-On

UNIT PACKAGE: 100



19419
(N811460-S100)

Diameter: 1/8"
Grip: 1/8"-3/16"
Flange Diameter: 3/8"
Steel Rivet (Black) & Steel Mandrel
Door Moulding
Ford Taurus 1996-On

UNIT PACKAGE: 15



21082
(75547-51021)

Diameter: 1/8" (3.2mm)
Nylon Shoulder Diameter: 1/4" (6.3mm)
Grip: 1/32" - 1/16" (.8mm - 1.5mm)
Flange Diameter: 13/32" (10.3mm)
Aluminum Rivet with Plastic Cap
Steel Mandrel
Windshield
Lexus IS 250, IS 350 & IS F 2006 - On
Toyota 2002 - On

UNIT PACKAGE: 15



21714
(Lexus: 90269-04060)

Specialty Rivet
Diameter: 5/32" (4mm)
Grip: 3/64" - 9/32" (1mm - 7mm)
Flange Diameter: 15/64" (6mm)
Steel Rivet & Mandrel
Lexus GS 300, GS 350, GS 430, GS 450h
& GS 460 2006 - On

UNIT PACKAGE: 25



22089
(GM: 92139150)

Front Bumper & Grille Specialty Rivet
Diameter: 5/32" (4mm)
Grip Range: 11/64" - 11/32" (4.4mm - 8.5mm)
Flange Diameter: 9/32" (7.1mm)
Aluminum Rivet & Stainless Steel Mandrel
Chevrolet Camaro 2012 - On

UNIT PACKAGE: 25



22173
(GM: 11611651)
Zinc & Clear Trivalent

Door & Exterior Trim Specialty Rivet
Diameter: 5/32" (4mm)
Grip Range: 3/64" - 5/32" (1mm - 4mm)
Flange Diameter: 5/16" (8mm)
Steel Rivet & Mandrel
Cadillac ATS, CTS, CTS-V & Escalade,
Chevrolet Avalanche, Camaro & Equinox and
GMC Terrain 2010 - On

UNIT PACKAGE: 50



22332
(Subaru: 905920039;
Toyota: 76879-48010)

Roof, Liftgate & Exterior Trim
Specialty Rivet with Plastic Cap
Rivet Diameter: 4mm (5/32")
Diameter of Plastic Cap: 5mm
Flange Diameter: 8mm (5/16")
Plastic Cap Flange Diameter:
10mm (Top), 12mm (Bottom)
Grip Range: .8mm - 2.4mm (.031" - .094")
Aluminum Rivet, Steel Mandrel
Subaru Forester, Impreza, Legacy,
Outback & XV Crosstrek 2015 - 2009
Toyota Prius 2009 - 2004

UNIT PACKAGE: 10

SPECIALTY RIVETS

18461

(Ford: N807620-S100; GM: 10131511)



Split-Type Rivet
 Diameter: 5/32"
 Grip: 3/64"-1/4"
 Flange Diameter: 5/16"
 Aluminum Rivet (Black) & Aluminum Mandrel
 Wheel Openings
 Lincoln 1994-On
 Bumper Cover, Grille & Rocker Moulding
 GM 1997 - On

UNIT PACKAGE: 25

20971

(Mazda: BBM450-355;
 Mercedes-Benz: 003-990-94-97)



Split-Type Rivet
 Diameter: 5/32" (4mm)
 Grip: 3/64" - 9/32" (1mm - 7mm)
 Flange Diameter: 5/16" (8mm)
 Aluminum Rivet & Mandrel
 Mazda 2012 - On
 Mercedes-Benz 2004 - On

UNIT PACKAGE: 25

21113

(01515-0009U)



Split-Type Rivet
 Diameter: 5/32" (4mm)
 Grip: 3/64" - 9/32" (1mm - 7mm)
 Flange Diameter: 5/16" (8mm)
 Aluminum Rivet (Black) & Aluminum Mandrel
 Bumper
 Nissan Pathfinder 2006 - On

UNIT PACKAGE: 25

20383

(90084-26002)



Diameter: 5/32" (4mm)
 Grip: 1/16" - 1/4" (1.6mm - 6.3mm)
 Flange Diameter: 5/16" (8mm)
 Aluminum Rivet & Mandrel
 Door Window Moulding
 Toyota Camry 1997 - On

UNIT PACKAGE: 50

16687

(GM: 9432137;
 Chry: 6032138)



Diameter: 5/32"
 Grip: 1/8" - 3/16"
 Flange Diameter: 5/16"
 Aluminum Rivet & Steel Mandrel
 Countersunk Head
 Trunk Lock Swivel Emblem Rivet
 GM 1973-On

UNIT PACKAGE: 25

21864

(Ford: W713819-S900)



Specialty Rivet
 Diameter: 5/32" (4mm)
 Grip: 3/64" - 1/8" (1.2mm - 3.2mm)
 Flange Diameter: 3/8" (9mm)
 Aluminum Rivet (Black) with Plastic Cap
 Steel Mandrel
 Cab & Exterior Trim
 Ford F-150 2014 - 2009

UNIT PACKAGE: 25

20629

(6036148-AA)



Split-Type Rivet
 Diameter: 5/32"
 Grip: 3/64" - 1/4"
 Flange Diameter: 7/16"
 Aluminum Rivet (Black) & Aluminum Mandrel
 Front Bumper, Trim Panel,
 Instrument Panel & Running Boards
 Chrysler 1999 - On

UNIT PACKAGE: 25

22088

(GM: 9132667)



Front & Rear Bumper Specialty Rivet
 Diameter: 5/32" (4mm)
 Grip Range: 9/64" - 3/8" (3.6mm - 9.5mm)
 Flange Diameter: 7/16" (11.1mm)
 Aluminum Rivet & Stainless Steel Mandrel
 Buick Regal & Verano; Chevrolet Avalanche, Camaro,
 Cruze, Malibu, Sonic & Volt 2010 - On

UNIT PACKAGE: 25

17468

(16715497)



Diameter: 5/32"
 Grip: 3/64"-1/4"
 Flange Diameter: 15/32"
 Aluminum Rivet & Steel Mandrel
 Attaches Support Rails to Load Floor
 GM

UNIT PACKAGE: 50

Sec. 14

SPECIALTY RIVETS



21742

(Toyota: 90269-06054)

Specialty Rivet
 Diameter: 5/32" (4mm)
 Grip: 3/64" - 3/8" (1mm - 9.5mm)
 Flange Diameter: 15/32" (12mm)
 Aluminum Rivet (Black) & Steel Mandrel (Black)
 European Toyota and Universal

UNIT PACKAGE: 25



18169

(15956062)

Diameter: 3/16"
 Grip: 1/8"-1/4"
 Flange Diameter: 11/32"
 Aluminum Rivet & Steel Mandrel
 Door Assembly
 GM Trucks C, K Models 1994-On

UNIT PACKAGE: 25



21715

(Toyota: 90269-04047)

Specialty Rivet
 Diameter: 5/32" (4mm)
 Grip: 3/64" - 15/32" (1mm - 12mm)
 Flange Diameter: 15/32" (12mm)
 Aluminum Rivet & Steel Mandrel (Black)
 Black Flange
 Toyota RAV4 & 4Runner 1996 - On

UNIT PACKAGE: 25



19514

(10125439, 10201332)

Split-Type Rivet
 Diameter: 3/16"
 Grip: 3/64"-15/64"
 Flange Diameter: 3/8"
 Aluminum Rivet (Black) & Aluminum Mandrel
 Door Actuator, Door, Body & Fender
 Moulding and Dash Panel Insulation
 Buick Regal, Chevrolet Lumina APV, K & T Trucks,
 Olds Silhouette and Pontiac Trans Sport 1990 - On

UNIT PACKAGE: 25



19376

(979878-6)

Diameter: 5/32" (4mm)
 Grip: 1/8"-11/32" (3mm-8.5mm)
 Flange Diameter: 15/32" (12mm)
 Aluminum Rivet (Black Polyethylene Coating)
 Aluminum Mandrel
 Bumper & Wheel Housing
 Volvo 1993-On

UNIT PACKAGE: 15



16864

(10125439)

Split-Type Rivet
 Diameter: 3/16"
 Grip: 3/64"-11/32"
 Flange Diameter: 3/8"
 Aluminum Rivet (Black) & Aluminum Mandrel
 Moulding Attachment
 APV Vans 1990 - On

UNIT PACKAGE: 25



17006

(N900-845-01)

Diameter: 5/32"
 Grip: 1/4" - 3/8"
 Flange Diameter: 15/32"
 Aluminum Rivet (Black) & Steel Mandrel
 Wheel Opening Moulding Attachment
 Jetta, Rabbit & Golf

UNIT PACKAGE: 25



22333

(Ford: W717984-S417)

Cab & Exterior Trim Countersunk
 Closed End Specialty Rivet
 Diameter: 4.8mm (3/16")
 Flange Diameter: 9.5mm (3/8")
 Grip Range: 1.6mm - 3.18mm (.063" - .125")
 Black Aluminum Rivet & Mandrel
 Ford F-150 2015 - On

UNIT PACKAGE: 15



15187

(N804583S)
 Black Nylon

Cowl Vent Grille
 Retainer Rivet
 Diameter: 5/32" (4mm)
 Grip: 15/64" - 13/32" (6mm-10.5mm)
 Flange Size: 11/32" x 5/8" (8.5mm x 15.5mm)
 Ford Aerostar 1986-On

UNIT PACKAGE: 25



20830

(N-904-374-01)

Diameter: 3/16" (4.8mm)
 Grip: 1/16" - 1/4" (1.6mm-6.4mm)
 Flange Diameter: 3/8" (10mm)
 Aluminum Rivet & Steel Mandrel
 Inner Fender
 Volkswagen

UNIT PACKAGE: 25

SPECIALTY RIVETS

Sec. 14



18912
(22585836, 22641917)

Diameter: 3/16"
Grip: 1/16" - 17/64"
Flange Diameter: 3/8"
Steel Rivet (Black) & Steel Mandrel (Zinc)
Rear Side Door Outside Handle Attachment
Cadillac DeVille & Seville, Chevrolet Cavalier and
Pontiac Sunfire 1994 - On

UNIT PACKAGE: 25



17410
(390428-S100)

Diameter: 3/16"
Grip: 3/8" - 1/2"
Flange Diameter: 3/8"
Closed End
Black Aluminum Rivet & Mandrel
Luggage Rack
Ford

UNIT PACKAGE: 25



19459
(384432-S)

Diameter: 3/16"
Grip: 1/16" - 1/8"
Flange Diameter: 3/8"
Aluminum Rivet & Steel Mandrel
Outer Moulding
Ford F Series & Villager
and Nissan Quest 1995 - On

UNIT PACKAGE: 25



19515
(15704030)

Diameter: 3/16"
Grip: 3/16" - 3/8"
Flange Diameter: 25/64"
Aluminum Rivet (Black)
Steel Mandrel (Zinc & Yellow)
Body Moulding, Bumper Fascia,
Hood Prop Rod and Window Hinge
Chev. Beretta, Camaro, Corsica &
Trucks, Olds Silhouette, Pontiac Firebird,
Grand Am and Trans Sport 1992 - On

UNIT PACKAGE: 25



21184
(003-990-24-97)

Door Handle, Air Bag, Rocker Moulding &
Window Regulator Rivet
Diameter: 3/16" (4.8mm)
Grip: 1/16" - 1/8" (1.6mm - 3.2mm)
Flange Diameter: 3/8" (9.5mm)
Steel Rivet & Mandrel
Mercedes-Benz 1998 - On

UNIT PACKAGE: 100



17121
(GM: 25618730;
Ford: N805592-S100)

Split-Type Rivet
Diameter: 3/16"
Grip: 5/64" - 15/64"
Flange Diameter: 7/16"
Aluminum Rivet (Black) & Aluminum Mandrel
Wheel House Moulding & General Purpose

UNIT PACKAGE: 25



21439

Diameter: M4.8 (3/16")
Grip: 1.5mm - 6mm (1/16" - 15/64")
Flange Diameter: 9mm (3/8")
Steel Rivet & Mandrel
Cadillac CTS; Chevrolet Colorado &
Equinox and GMC Canyon & Terrain 2004 - On

UNIT PACKAGE: 50



18927
(22569178,
22579423)



18329
(3828472)

Diameter: 3/16"
Grip: 1/4" - 3/8"
Flange Diameter: 3/8"
Aluminum Rivet (Black) & Aluminum Mandrel
Attachment of Front Fender Lower Rocker Moulding
Chevrolet Astro & GMC Safari Mini-Vans 1995 - On

UNIT PACKAGE: 50

Split-Type Rivet
Diameter: 3/16"
Grip: 5/16" - 7/16"
Flange Diameter: 7/16"
Aluminum Rivet & Steel Mandrel (Zinc)
Front & Rear Door Window Sash Attachment
Buick Skylark, Chevrolet Cavalier,
Olds Achieva & Pontiac Grand Am 1992-On

UNIT PACKAGE: 25

Sec. 14

SPECIALTY RIVETS



18244
(GM:
15614774)

Split-Type Rivet
Diameter: 3/16"
Grip: 3/16"-3/8"
Flange Diameter: 29/64"
Aluminum Rivet (Black) & Aluminum Mandrel
For Camper Style Mirrors on GM Trucks

UNIT PACKAGE: 10



20834
(90269-06013)

Diameter: 3/16" (4.8mm)
Grip: 1/16" - 1/4" (1.6mm - 6.35mm)
Flange Diameter: 9/16" (14mm)
Aluminum Rivet with Plastic Cap
Steel Mandrel
Gas Filler Door
Toyota Camry & Lexus IS300 2001 - On

UNIT PACKAGE: 15



21713
(Toyota: 90269-05034,
90269-05056)

Specialty Rivet
Diameter: 3/16" (5mm)
Grip: 3/64" - 15/32" (1mm - 12mm)
Flange Diameter: 1/2" (13mm)
Aluminum Rivet with Plastic Cap
Steel Mandrel
Lexus IS 300 and Toyota Celica, Corolla,
Matrix, Prius, RAV4, Tercel & Yaris 2000 - On

UNIT PACKAGE: 25



20626
(90269-05054)

Diameter: 3/16" (5mm)
Grip: 1/8" - 5/16" (3mm - 8mm)
Flange Diameter: 9/16" (14mm)
Aluminum Rivet with Plastic Cap
Steel Mandrel
Windshield Side Moulding & Gas Filler Cap
Toyota Camry & Sienna 1997 - On

UNIT PACKAGE: 10



21046
(90269-05065)

Diameter: 3/16" (5mm)
Grip: 5/32" - 9/32" (4mm - 7mm)
Flange Diameter: 1/2" (13mm)
Aluminum Rivet with Plastic Cap
Steel Mandrel
Bumpers & General Purpose
Lexus 2004 - On

UNIT PACKAGE: 10

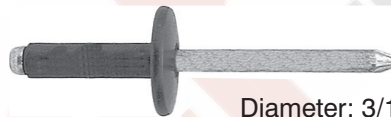

14127
(388664-S100)

Diameter: 3/16"
Grip: 3/8"-1/2"
Flange Diameter: 9/16"
Aluminum Rivet (Black) & Aluminum Mandrel
Fascia & Bumper
Ford 1982 - On

UNIT PACKAGE: 25



17641
(9442361, 25609048)

Diameter: 3/16"
Grip: 3/64"-13/64"
Flange Diameter: 9/16"
Aluminum Rivet (Black) & Steel Mandrel (Zinc)
Used in place of screws when attaching
new Catalytic Converter Heat Shield
Buick LeSabre & Roadmaster, Cadillac Brougham
and Oldsmobile 98 & 88 1986 - On

UNIT PACKAGE: 25

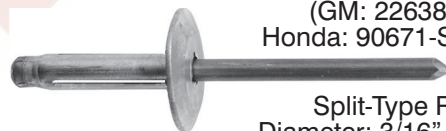

20740
(GM: 22638717;
Honda: 90671-SDA-A01)

Split-Type Rivet
Diameter: 3/16" (4.8mm)
Grip Range: 3/64" - 23/64" (1mm - 9mm)
Flange Diameter: 5/8" (16mm)
Aluminum Rivet & Mandrel
Bumper Fascia & General Purpose
GM 1987 - On
Honda Civic 2016 - On

UNIT PACKAGE: 25



18749
(9439559,
21021319)

Diameter: 3/16"
Grip: 1/16"-1/4"
Flange Diameter: 9/16"
Aluminum Rivet (Black) & Steel Mandrel
Rocker Panel Cover
GM Saturn 1991 - On

UNIT PACKAGE: 50

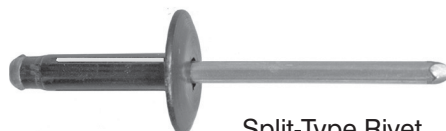

20741
(11516807)

Split-Type Rivet
Diameter: 3/16" (4.8mm)
Grip: 3/64" - 23/64" (1mm-9mm)
Flange Diameter: 5/8" (16mm)
Aluminum Rivet (Black) & Aluminum Mandrel
Bumper Fascia & General Purpose
GM 1990 - On

UNIT PACKAGE: 25

SPECIALTY RIVETS

Sec. 14



21799
 Split-Type Rivet
 Diameter: 3/16"
 Grip Range: 7/64" - 3/8"
 Flange Diameter: 5/8"
 Aluminum Rivet & Mandrel
 General Purpose
 UNIT PACKAGE: 15



19460
 (385974-S)
 Diameter: 3/16"
 Grip: 3/16"-1/4"
 Flange Diameter: 5/8"
 Aluminum Rivet & Steel Mandrel
 General Purpose
 Ford Econoline & Windstar 1995 - On
 UNIT PACKAGE: 50



22264
 (Ford:W714004-S900)
 Liftgate, Exterior Trim & Quarter Panel Specialty Rivet
 Diameter: 3/16" (4.8mm)
 Grip Range: 3/16" - 3/8" (4.75mm - 9.53mm)
 Flange Diameter: 7/16" (11mm)
 Black Aluminum Rivet & Aluminum Mandrel
 Ford Explorer & Flex 2009 - On
 UNIT PACKAGE: 25



18168
 (9433186)
 Diameter: 3/16"
 Grip 1/4"-3/8"
 Flange Diameter: 5/8"
 Steel Rivet (Zinc) & Steel Mandrel
 Front & Rear Bumper
 GM Saturn 1991 - On
 UNIT PACKAGE: 50



12657
 (9439719)
 Diameter: 3/16"
 Grip: 1/4"-3/8"
 Flange Diameter: 5/8"
 Steel Rivet (Black) & Steel Mandrel
 Attaches Fascia to Underside Bumper
 GM 1981 - On
 UNIT PACKAGE: 50



16940
 (GM: 2085119, 3533539, 3540161;
 Not Supplied by Chrysler O.E.M.)
 Diameter: 3/16"
 Grip: 1/2" - 5/8"
 Flange Diameter: 5/8"
 Aluminum Rivet & Mandrel
 Glass Stop/Roller Rivet
 Chrysler
 Front Bumper Fascia Lower Deflector
 Cadillac 1993 - 87
 UNIT PACKAGE: 25



17466
 (N905150-S)
 Diameter: 3/16"
 Grip: 1/2"-5/8"
 Flange Diameter: 5/8"
 Aluminum Rivet & Steel Mandrel
 Attaches License Plate Bracket
 Ford
 UNIT PACKAGE: 25



18935
 (10160960)
 Diameter: 3/16"
 Grip: 1/2" - 25/32"
 Flange Diameter: 5/8"
 Aluminum Rivet & Steel Mandrel (Zinc)
 Liftgate Strut Gate Side Bracket
 Lumina APV, Silhouette & Trans Sport 1992 - On
 UNIT PACKAGE: 25



17977
 (Not Supplied by O.E.M.)
 Diameter: 3/16"
 Grip: 5/8"-3/4"
 Flange Diameter: 5/8"
 Aluminum Rivet & Mandrel
 Glass Stop/Roller Rivet
 Chrysler
 UNIT PACKAGE: 25



19111
 (N807168-S)
 Diameter: 3/16"
 Grip: 11/16"-13/16"
 Flange Diameter: 3/4"
 Aluminum Rivet & Mandrel
 Grille & Bumper
 Ford Windstar 1995 - On
 UNIT PACKAGE: 25

Sec. 14

SPECIALTY RIVETS

22122

(Mercedes: 003-990-35-97)



Specialty Rivet
Diameter: 6.3mm (1/4")
Grip Range: 1.0mm - 8.5mm (.039" - .335")
Flange Diameter: 11mm (7/16")
Aluminum Rivet & Steel Mandrel
Mercedes 2012 - 1990

UNIT PACKAGE: 15

21124

(11610383)



Diameter: 1/4"
Grip: 1/64" - 1/8"
Flange Outer Diameter: 1/2"
Steel Rivet (Zinc) & Steel Mandrel
Step Bumper
GM Silverado & Sierra Pick-Ups 2007 - On

UNIT PACKAGE: 25

22266

(GM: 11561334)
Zinc



Rear Compartment, Rocker & Wheelhouse Specialty Rivet
Diameter: 1/4" (6.3mm)
Grip Range: .059" - .138" (1.48mm - 3.50mm)
Flange Diameter: 1/2" (12.70mm)
Steel Rivet & Mandrel
Various GM Models, Cadillac CTS & SRX 2015 - 2009
Cadillac CT6 2016 - On

UNIT PACKAGE: 15

HAVE YOU VISITED US ONLINE?

Auveco's website has been completely renovated. Our new design is user friendly with easy navigation and ordering.

Product is searchable by car make, OEM number and category, as well as, several attribute drop downs within individual categories. All product also has stock availability listed.

Make sure to head over to www.auveco.com to receive up to date information on all our products.

22067

(Ford: W707638-S900C)
Zinc



Cab, Rear Body, Floor, Door, Box, Wheel House & Back Panel Specialty Rivet
Diameter: 1/4" (6.3mm)
Grip: .060"-.138" (1.5mm - 3.5mm)
Flange Diameter: 1/2" (13mm)
Steel Rivet & Mandrel
Ford F-150 Trucks with Aluminum Body 2015 - On

UNIT PACKAGE: 10

18889

(22643056)
Zinc & Yellow Dichromate



Diameter: 1/4"
Grip: 1/16" - 5/32"
Flange Diameter: 1/2"
Steel Rivet & Mandrel
Door Window Regulator
Buick Skylark, Chevrolet Cavalier, Olds Achieva & Aurora, and Pontiac Grand Am & Sunfire 1995-On

UNIT PACKAGE: 25

21315

(90269-A0005,
90269-06017)



Diameter: 1/4" (6.3mm)
Grip: 1/16" - 3/16" (1.6mm - 4.8mm)
Flange Diameter: 1/2" (13mm)
Aluminum Rivet (Black) & Steel Mandrel
Fuel Door & General Purpose
Toyota and Lexus 2000 - On
Scion 2005 - On

UNIT PACKAGE: 10

18938

(2024778)
Zinc



Diameter: 1/4"
Grip: 1/16"-1/4"
Flange Diameter: 1/2"
Steel Rivet & Mandrel
Front Side Door Window Regulator
Chevrolet Lumina APV, Olds Silhouette & Pontiac Trans Sport 1990 - On

UNIT PACKAGE: 25

SPECIALTY RIVETS

16939

(10157547)

Yellow Dichromate Coated



Diameter: 1/4"
Grip: 5/64" - 3/8"
Flange Diameter: 1/2"
Aluminum Rivet & Steel Mandrel
Front Door Window Regulator
GM APV Vans 1990 - On

UNIT PACKAGE: 10

18810

(6033688)

Zinc & Yellow



Diameter: 1/4"
Grip: 7/64" - 3/16"
Flange Diameter: 1/2"
Steel Rivet & Mandrel
Glass & Frame Assembly and
Floor Pan Reinforcement Attachment
Dodge Shadow, Plymouth Sundance
& Jeep Cherokee 1991 - On

UNIT PACKAGE: 25

22023

(Ford: W702512-S900C)

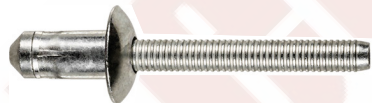

Fender, Sill & Radiator Support Specialty Rivet
Diameter: 1/4" (6.3mm)
Grip: .110" - .189" (2.79mm - 4.8mm)
Flange Diameter: 1/2" (13mm)
Steel Rivet & Mandrel
Ford F-150 Trucks with Aluminum Body 2015

UNIT PACKAGE: 10

12654

(372820-S36, S40)



Diameter: 1/4"
Grip: 1/8" - 1/4"
Flange Diameter: 1/2"
Steel Rivet (Zinc & Gold Chrome) & Steel Mandrel
Front Bumper Assembly
Ford 1979 - On

UNIT PACKAGE: 25

22265

(Mercedes: 000-991-59-32)



Front & Rear Door Specialty Rivet
Diameter: 6.3mm (1/4")
Grip Range: 3.5mm - 6.5mm (.138" - .265")
Flange Diameter: 16mm (5/8")
Aluminum Rivet & Steel Mandrel
Mercedes-Benz CLA & GLA Class 2014 - On

UNIT PACKAGE: 15

21286

(Ford: W708777-S900C;
Mercedes: 004-990-16-97)
Zinc



Specialty Rivet
Diameter: 1/4" (6.3mm)
Grip: 3/16" - 17/64" (4.80mm - 6.80mm)
Flange Diameter: 1/2" (13mm)
Steel Rivet & Mandrel
Cab, Radiator, Rail, Floor, Door, Pillar,
Cowl, Box & Back Panel
Ford F-150 Trucks with Aluminum Body 2015 - On
Mercedes Benz 2008 - On

UNIT PACKAGE: 10

22066

(Ford: W702554-S900C)
Zinc



Cab, Floor, Door, Pillar, Box &
Cowl Specialty Rivet
Diameter: 1/4" (6.3mm)
Grip: .268" - .346" (6.8mm - 8.8mm)
Flange Diameter: 1/2" (13mm)
Steel Rivet & Mandrel
Ford F-150 Trucks with
Aluminum Body 2015 - On

UNIT PACKAGE: 10

Sec. 14

SPECIALTY RIVETS

21245
(W705297-S300)

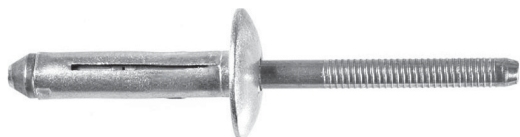

Split-Type Rivet
Diameter: 1/4"
Grip Range: 3/16" - 3/8"
Flange Diameter: 11/16"
Aluminum Rivet & Mandrel
Bumper Cover
Ford Fusion 2009 - On

UNIT PACKAGE: 15

21440
(Not Available from O.E.M.)



Closed End Rivet
Diameter: 1/4"
Grip Range: 1/4" - 3/8"
Flange Diameter: 1/2"
Aluminum Rivet & Steel Mandrel
General Purpose

UNIT PACKAGE: 25

18170
(10204266)



Diameter: 1/4"
Grip: 3/4"-1"
Flange Diameter: 1/2"
Aluminum Rivet & Mandrel
Trunk Lock Cylinder
Pontiac Firebird 1994 - On

UNIT PACKAGE: 10

19516
(N804851-S100)

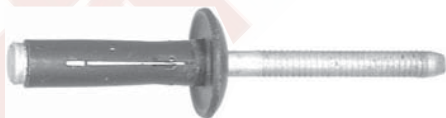

Split-Type Rivet
Diameter: 1/4"
Grip: 3/64"-1/4"
Flange Diameter: 9/16"
Aluminum Rivet (Black) & Aluminum Mandrel
Front Bumper
Ford Taurus 1996 - On

UNIT PACKAGE: 15

17639
(Ford: N806830-S100;
Chry: 6035201)



Split-Type Rivet
Diameter: 1/4"
Grip: 3/16"-3/8"
Flange Diameter: 11/16"
Aluminum Rivet & (Black) Aluminum Mandrel
Attachment of Bumper Cover to Bumper &
Front License Plate Bracket to Bumper Cover
Ford 1992 - On
Air Dam to Fascia
Chrysler 1993 - On

UNIT PACKAGE: 15

19263

Same as 17639 except for unit package quantity

UNIT PACKAGE: 25

18331

(N805995-S100,
W701566-S417)



Diameter: 1/4"
Grip: 1/32"-7/32"
Flange Diameter: 3/4"
Aluminum Rivet (Black) & Aluminum Mandrel (Yellow)
Attachment of Power Door Lock Actuator
Mustang & Lincoln Continental 1994-On

UNIT PACKAGE: 10

12652
(388442-S100)



Diameter: 1/4"
Grip: 1/8"-1/4"
Flange Diameter: 3/4"
Steel Rivet (Black) & Steel Mandrel
Bumper Assembly
Escort & Lynx 1981 - On

UNIT PACKAGE: 25

DRILLS & DRILL SETS

Straight Shank 135° Split Point Black Finish



Auveco Part No.	Unit Pkg.	Size	Dec. Equiv.	Flute Length	Overall Length
13039	5	3/32"	.0938	1-1/4"	2-1/4"
13040	5	7/64"	.1094	1-1/2"	2-5/8"
13041	5	1/8"	.1250	1-5/8"	2-3/4"
13095	5	30	.1285	1-5/8"	2-3/4"
13042	5	9/64"	.1406	1-3/4"	2-7/8"
13043	5	5/32"	.1562	2"	3-1/8"
13044	5	11/64"	.1719	2-1/8"	3-1/4"
13045	5	3/16"	.1875	2-5/16"	3-1/2"
13046	5	13/64"	.2031	2-7/16"	3-5/8"
13047	5	7/32"	.2188	2-1/2"	3-3/4"
13048	5	15/64"	.2344	2-5/8"	3-7/8"
13049	5	1/4"	.2500	2-3/4"	4"
13050	5	17/64"	.2656	2-7/8"	4-1/8"
13051	5	9/32"	.2812	2-15/16"	4-1/4"
13052	5	19/64"	.2969	3-1/16"	4-3/8"
13053	5	5/16"	.3125	3-3/16"	4-1/2"
13054	5	21/64"	.3281	3-5/16"	4-5/8"
13055	5	11/32"	.3438	3-7/16"	4-3/4"
13056	5	23/64"	.3594	3-1/2"	4-7/8"
13057	5	3/8"	.3750	3-5/8"	5"
13058	5	25/64"	.3906	3-3/4"	5-1/8"
13059	5	13/32"	.4062	3-7/8"	5-1/4"
13060	5	27/64"	.4219	3-15/16"	5-3/8"
13061	5	7/16"	.4375	4-1/16"	5-1/2"
13062	5	29/64"	.4531	4-3/16"	5-5/8"
13063	5	15/32"	.4688	4-5/16"	5-3/4"
13064	5	31/64"	.4844	4-3/8"	5-7/8"
13065	3	1/2"	.5000	4-1/2"	6"

Cobalt Steel Spot Weld Drills



Auveco Part No.	Unit Pkg.	Size	Flute Length	Overall Length
20479	3	8mm (5/16")	27mm (1-1/16")	58mm (2-1/4")
20480	3	10mm (3/8")	27mm (1-1/16")	58mm (2-1/4")

High Speed Jobber Length Drill Set Metal Drill Indexes



13136

Jobbers Length Straight Shank
135° Split Point
Sizes 1/16" thru 1/2" by 64th
29 Pieces

UNIT PACKAGE: 1 Set

Screw Machine Length Drills 135° Split Point Straight Shank • Black Finish



Auveco Part No.	Unit Pkg.	Size	Dec. Equiv.	Flute Length	Overall Length
13120	5	1/16"	.0625	5/8"	1-5/8"
13121	5	5/64"	.0781	11/16"	1-11/16"
13124*	5	1/8"	.1250	7/8"	1-7/8"
13128	5	3/16"	.1875	1-1/8"	2-3/16"
13132	5	1/4"	.2500	1-3/8"	2-1/2"
13133	5	5/16"	.3125	1-5/8"	2-13/16"
13134	2	3/8"	.3750	1-13/16"	3-1/8"

* For 1/8" Pop Rivets

12676

Black Finish



Double-End Drill Bit
135° Split Point
Diameter: 1/8" (.125)
Length: 2"

UNIT PACKAGE: 5

Sec. 15

RETAIL MERCHANDISER

AuvecoPak AP448 Retail Merchandiser

AuvecoPak part numbers are the same as standard Auveco part numbers with an "AP" prefix. Thus AP11146 is the AuvecoPak version of 11146.

AP448S (Starter Merchandiser): One package each of 448 part numbers

AP448L (Large Merchandiser): Two packages each of the 224 most popular items and one package each of the other 224 part numbers for a total of 672 packages.



The AuvecoPak merchandisers (AP448S and AP448L) provide 448 of the fastest moving, most popular automotive body hardware and specialty fasteners.

Each of the 7 panels contains 32 part numbers per side.

The AP448S (Starter Merchandiser) consists of one package each of the 448 part numbers. The AP448L (Large Assortment) includes two packages each of the 224 most popular items and one package each of the other 224 part numbers for a total of 672 packages.

Two header signs identify the AP448 as an Auveco merchandiser, along with the phrase automotive body hardware and specialty fasteners. Eye-catching color scheme and graphics make the merchandiser visually appealing and portray the contents of the merchandiser.

Initial set-up is easy. The panels come "pre-dressed" with the AuvecoPaks already in place. Simply position the top and bottom brackets on a gondola or pegboard wall. Insert the panels into the brackets.

An individual panel measures 6-1/2" (wide) x 17-1/2" (front to back) x 44-1/2" (high). Merchandisers (AP448S and AP448L) fit on a gondola with 48" x 48" of pegboard or on any pegboard wall.

A gondola is not included with the AP448S or the AP448L. Auveco customer service reps can recommend a source for gondolas.

AuvecoPak packages feature, contemporary graphics with all the necessary application and descriptive information in trilingual verbiage (English, Spanish and French-Canadian).

Re-ordering is a breeze, the AuvecoPak part number and UPC-A bar code are on the panel back-up boards beneath each hook. Restocking the merchandiser is also quick and easy with the AuvecoPak packages' locator codes identifying their specific location on the panels.



Refer to contents listing for each panel on following pages

AuvecoPak AP448 Retail Merchandiser Contents

Sec. 15

AuvecoPak part numbers are the same as standard Auveco part numbers with an "AP" prefix. Thus AP11146 is the AuvecoPak version of 11146. *Photos not actual size.*

Panel T1 Retainers

AP10832	AP11831	AP11146	AP17664
AP20192	AP11120	AP14921	AP14021
AP11612	AP11721	AP15367	AP17612
AP11679	AP19837	AP16818	AP12731
AP18301	AP14032	AP14036	AP12766
AP15543	AP20366	AP20316	AP11351
AP20362	AP12137	AP15481	AP15480
AP12571	AP12909	AP15479	AP15998



Panel T2 Retainers & Trim Panel Fasteners

AP15457	AP12759	AP15456	AP11130
AP17649	AP12565	AP13470	AP18848
AP11671	AP15970	AP12992	AP19386
AP18915	AP11797	AP18930	AP17075
AP19270	AP16695	AP15461	AP11678
AP11672	AP13461	AP10621	AP12737
AP11796	AP808	AP11863	AP2310
AP2309	AP12134	AP19682	AP18114



Panel U1 Retaining Clips & Retainers

AP19114	AP14356	AP19729	AP20543
AP14355	AP14291	AP18297	AP14736
AP14737	AP19113	AP18842	AP17975
AP19655	AP14738	AP17004	AP14163
AP17339	AP19171	AP18877	AP18033
AP14328	AP10744	AP8853	AP14016
AP17162	AP16782	AP16784	AP11705
AP11699	AP20248	AP11706	AP18353



Panel U2 Push-Type Retainers

AP12567	AP14011	AP14010	AP12757
AP20335	AP20869	AP20908	AP20349
AP19239	AP19118	AP20955	AP18888
AP19274	AP20247	AP20986	AP19453
AP19233	AP19246	AP20327	AP20564
AP19801	AP19639	AP17222	AP20888
AP17103	AP16622	AP13996	AP13993
AP20931	AP20458	AP19615	AP20889



Panel V1 Push-Type Retainers

AP18873	AP20632	AP19422	AP17216
AP13994	AP15044	AP14019	AP14020
AP15042	AP14696	AP14697	AP14260
AP17379	AP16000	AP17632	AP17267
AP14997	AP16858	AP20348	AP17439
AP14992	AP14753	AP17472	AP17057
AP19140	AP19739	AP17143	AP16835
AP18119	AP14994	AP17144	AP19613



Panel V2 Rivets

AP13748	AP13755	AP14023	AP18108
AP13751	AP13750	AP17101	AP13752
AP13753	AP20788	AP20627	AP20834
AP16834	AP17615	AP17006	AP18461
AP20629	AP19376	AP16864	AP17121
AP17410	AP20741	AP14127	AP12652
AP17639	AP8309	AP8925	AP8931
AP5753	AP8311	AP8301	AP8313



Panel W1 Rivets, Specialty Nuts & Nylon Nuts

AP11620	AP11621	AP12655	AP12653
AP18167	AP13007	AP13009	AP13008
AP13004	AP13010	AP16253	AP16251
AP13014	AP13016	AP13017	AP13232
AP15326	AP12595	AP15335	AP18153
AP11855	AP9829	AP10330	AP11691
AP9862	AP13450	AP13960	AP13933
AP13932	AP14274	AP14313	AP3682



Panel W2 Nylon Nuts, Screw Grommets, Thread Cutting Nuts, Push-On Retainers & Pushnut Bolt Retainers

AP11719	AP8435	AP14695	AP20954
AP19194	AP19756	AP20440	AP19721
AP14267	AP19614	AP12255	AP15711
AP3403	AP2895	AP8855	AP3404
AP2896	AP2897	AP3405	AP10733
AP2557	AP8863	AP8864	AP8865
AP8868	AP8869	AP10374	AP10086
AP10087	AP9297	AP9299	AP12127



Sec. 15

AuvecoPak AP448 Retail Merchandiser Contents

AuvecoPak part numbers are the same as standard Auveco part numbers with an "AP" prefix. Thus AP11146 is the AuvecoPak version of 11146. *Photos not actual size.*

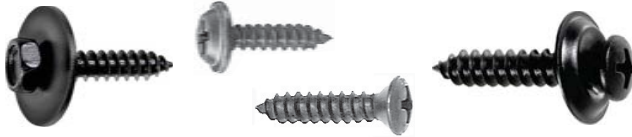

Panel X1
Black Tapping Screws

AP12213	AP12214	AP12215	AP12216
AP12217	AP12218	AP12953	AP12954
AP12957	AP11788	AP11789	AP11791
AP11792	AP15774	AP13026	AP17650
AP12820	AP12060	AP18340	AP17459
AP20259	AP20455	AP16323	AP10165
AP10167	AP10181	AP10182	AP11922
AP12741	AP12742	AP15775	AP15373



Panel X2
License Plate Screws, Body Bolts & Zinc/Chrome Tapping Screws

AP18354	AP16421	AP12351	AP12339
AP10823	AP9480	AP10362	AP11320
AP5711	AP11109	AP11110	AP12324
AP12693	AP12067	AP12160	AP12065
AP12066	AP11633	AP13613	AP12348
AP13614	AP10642	AP2805	AP12095
AP13708	AP15172	AP2806	AP13027
AP2710	AP1799	AP2713	AP1483



Panel Y1
License Plate Screws, Zinc/Chrome Tapping Screws & Body Bolts, Bumper Bolts & Headlight Adjusting Screws

AP1717	AP2730	AP2775	AP2771
AP2751	AP2772	AP2773	AP3466
AP3467	AP17098	AP17980	AP19777
AP11369	AP9603	AP16960	AP14473
AP17315	AP17316	AP16826	AP15170
AP17034	AP12335	AP9615	AP11914
AP8443	AP9355	AP3099	AP3102
AP3178	AP11655	AP11826	AP11243



Panel Y2
Moulding Clips, Clips & Fasteners and Door Hinge Pins & Bushings

AP2744	AP19626	AP2619	AP2752
AP19807	AP19378	AP9965	AP15695
AP20687	AP20390	AP20391	AP20688
AP14642	AP11152	AP19800	AP19757
AP20607	AP20774	AP20328	AP20377
AP19822	AP19821	AP8941	AP11067
AP9633	AP9639	AP9749	AP14559
AP14550	AP14553	AP16936	AP16937



Panel Z1
Extruded U-Nuts, Cage Nuts, Spring Type U-Nuts, Fender & Bumper Cover Nut and Retainer

AP10048	AP15677	AP8359	AP10051
AP10053	AP8814	AP10054	AP10055
AP11625	AP11626	AP16846	AP12669
AP16842	AP16322	AP12575	AP11628
AP11629	AP11630	AP11631	AP14750
AP5586	AP5589	AP5170	AP20758
AP10064	AP10065	AP9880	AP20757
AP9879	AP10066	AP15752	AP10067



Panel Z2
U-Nuts, Flat Nuts, Tubular Nuts, Cable Straps, Wire Loom Clips, Rubber Bumpers, Sheet Metal Plugs, Vacuum Caps, Shims & Miscellaneous

AP10666	AP13225	AP11292	AP5197
AP2293	AP2099	AP2103	AP1903
AP2611	AP2595	AP5195	AP10073
AP2288	AP15518	AP14298	AP20380
AP14546	AP14547	AP19440	AP20397
AP11746	AP4233	AP4188	AP4474
AP9288	AP4440	AP4439	AP2453
AP5076	AP5077	AP3155	AP3156

AuvecoPak AP448

Retail Merchandiser Contents

Sec. 15

Part Number Location Chart

Auveco Pak No.	Location			Auveco Pak No.	Location		
AP808	Panel T2	Row 7	Position 2	AP8301	Panel V2	Row 8	Position 3
AP1483	Panel X2	Row 8	Position 4	AP8309	Panel V2	Row 7	Position 2
AP1717	Panel Y1	Row 1	Position 1	AP8311	Panel V2	Row 8	Position 2
AP1799	Panel X2	Row 8	Position 2	AP8313	Panel V2	Row 8	Position 4
AP1903	Panel Z2	Row 2	Position 4	AP8359	Panel Z1	Row 1	Position 3
AP2099	Panel Z2	Row 2	Position 2	AP8435	Panel W2	Row 1	Position 2
AP2103	Panel Z2	Row 2	Position 3	AP8443	Panel Y1	Row 7	Position 1
AP2288	Panel Z2	Row 4	Position 1	AP8814	Panel Z1	Row 2	Position 2
AP2293	Panel Z2	Row 2	Position 1	AP8853	Panel U1	Row 6	Position 3
AP2309	Panel T2	Row 8	Position 1	AP8855	Panel W2	Row 4	Position 3
AP2310	Panel T2	Row 7	Position 4	AP8863	Panel W2	Row 6	Position 2
AP2453	Panel Z2	Row 7	Position 4	AP8864	Panel W2	Row 6	Position 3
AP2557	Panel W2	Row 6	Position 1	AP8865	Panel W2	Row 6	Position 4
AP2595	Panel Z2	Row 3	Position 2	AP8868	Panel W2	Row 7	Position 1
AP2611	Panel Z2	Row 3	Position 1	AP8869	Panel W2	Row 7	Position 2
AP2619	Panel Y2	Row 1	Position 3	AP8925	Panel V2	Row 7	Position 3
AP2710	Panel X2	Row 8	Position 1	AP8931	Panel V2	Row 7	Position 4
AP2713	Panel X2	Row 8	Position 3	AP8941	Panel Y2	Row 6	Position 3
AP2730	Panel Y1	Row 1	Position 2	AP9288	Panel Z2	Row 7	Position 1
AP2744	Panel Y2	Row 1	Position 1	AP9297	Panel W2	Row 8	Position 2
AP2751	Panel Y1	Row 2	Position 1	AP9299	Panel W2	Row 8	Position 3
AP2752	Panel Y2	Row 1	Position 4	AP9355	Panel Y1	Row 7	Position 2
AP2771	Panel Y1	Row 1	Position 4	AP9480	Panel X2	Row 2	Position 2
AP2772	Panel Y1	Row 2	Position 2	AP9603	Panel Y1	Row 4	Position 2
AP2773	Panel Y1	Row 2	Position 3	AP9615	Panel Y1	Row 6	Position 3
AP2775	Panel Y1	Row 1	Position 3	AP9633	Panel Y2	Row 7	Position 1
AP2805	Panel X2	Row 6	Position 3	AP9639	Panel Y2	Row 7	Position 2
AP2806	Panel X2	Row 7	Position 3	AP9749	Panel Y2	Row 7	Position 3
AP2895	Panel W2	Row 4	Position 2	AP9829	Panel W1	Row 6	Position 2
AP2896	Panel W2	Row 5	Position 1	AP9862	Panel W1	Row 7	Position 1
AP2897	Panel W2	Row 5	Position 2	AP9879	Panel Z1	Row 8	Position 1
AP3099	Panel Y1	Row 7	Position 3	AP9880	Panel Z1	Row 7	Position 3
AP3102	Panel Y1	Row 7	Position 4	AP9965	Panel Y2	Row 2	Position 3
AP3155	Panel Z2	Row 8	Position 3	AP10048	Panel Z1	Row 1	Position 1
AP3156	Panel Z2	Row 8	Position 4	AP10051	Panel Z1	Row 1	Position 4
AP3178	Panel Y1	Row 8	Position 1	AP10053	Panel Z1	Row 2	Position 1
AP3403	Panel W2	Row 4	Position 1	AP10054	Panel Z1	Row 2	Position 3
AP3404	Panel W2	Row 4	Position 4	AP10055	Panel Z1	Row 2	Position 4
AP3405	Panel W2	Row 5	Position 3	AP10064	Panel Z1	Row 7	Position 1
AP3466	Panel Y1	Row 2	Position 4	AP10065	Panel Z1	Row 7	Position 2
AP3467	Panel Y1	Row 3	Position 1	AP10066	Panel Z1	Row 8	Position 2
AP3682	Panel W1	Row 8	Position 4	AP10067	Panel Z1	Row 8	Position 4
AP4188	Panel Z2	Row 6	Position 3	AP10073	Panel Z2	Row 3	Position 4
AP4233	Panel Z2	Row 6	Position 2	AP10086	Panel W2	Row 7	Position 4
AP4439	Panel Z2	Row 7	Position 3	AP10087	Panel W2	Row 8	Position 1
AP4440	Panel Z2	Row 7	Position 2	AP10165	Panel X1	Row 6	Position 4
AP4474	Panel Z2	Row 6	Position 4	AP10167	Panel X1	Row 7	Position 1
AP5076	Panel Z2	Row 8	Position 1	AP10181	Panel X1	Row 7	Position 2
AP5077	Panel Z2	Row 8	Position 2	AP10182	Panel X1	Row 7	Position 3
AP5170	Panel Z1	Row 6	Position 3	AP10330	Panel W1	Row 6	Position 3
AP5195	Panel Z2	Row 3	Position 3	AP10362	Panel X2	Row 2	Position 3
AP5197	Panel Z2	Row 1	Position 4	AP10374	Panel W2	Row 7	Position 3
AP5586	Panel Z1	Row 6	Position 1	AP10621	Panel T2	Row 6	Position 3
AP5589	Panel Z1	Row 6	Position 2	AP10642	Panel X2	Row 6	Position 2
AP5711	Panel X2	Row 3	Position 1	AP10666	Panel Z2	Row 1	Position 1
AP5753	Panel V2	Row 8	Position 1	AP10733	Panel W2	Row 5	Position 4

Sec. 15

AuvecoPak AP448

Retail Merchandiser Contents

Part Number Location Chart

Auveco Pak No.	Location			Auveco Pak No.	Location		
AP10744	Panel U1	Row 6	Position 2	AP12137	Panel T1	Row 7	Position 2
AP10823	Panel X2	Row 2	Position 1	AP12160	Panel X2	Row 4	Position 3
AP10831	Panel T1	Row 1	Position 2	AP12213	Panel X1	Row 1	Position 1
AP10832	Panel T1	Row 1	Position 1	AP12214	Panel X1	Row 1	Position 2
AP11067	Panel Y2	Row 6	Position 4	AP12215	Panel X1	Row 1	Position 3
AP11109	Panel X2	Row 3	Position 2	AP12216	Panel X1	Row 1	Position 4
AP11110	Panel X2	Row 3	Position 3	AP12217	Panel X1	Row 2	Position 1
AP11120	Panel T1	Row 2	Position 2	AP12218	Panel X1	Row 2	Position 2
AP11130	Panel T2	Row 1	Position 4	AP12255	Panel W2	Row 3	Position 3
AP11146	Panel T1	Row 1	Position 3	AP12324	Panel X2	Row 3	Position 4
AP11152	Panel Y2	Row 4	Position 2	AP12335	Panel Y1	Row 6	Position 2
AP11243	Panel Y1	Row 8	Position 4	AP12339	Panel X2	Row 1	Position 4
AP11292	Panel Z2	Row 1	Position 3	AP12348	Panel X2	Row 5	Position 4
AP11320	Panel X2	Row 2	Position 4	AP12351	Panel X2	Row 1	Position 3
AP11351	Panel T1	Row 6	Position 4	AP12565	Panel T2	Row 2	Position 2
AP11369	Panel Y1	Row 4	Position 1	AP12567	Panel U2	Row 1	Position 1
AP11612	Panel T1	Row 3	Position 1	AP12571	Panel T1	Row 8	Position 1
AP11620	Panel W1	Row 1	Position 1	AP12575	Panel Z1	Row 4	Position 3
AP11621	Panel W1	Row 1	Position 2	AP12595	Panel W1	Row 5	Position 2
AP11625	Panel Z1	Row 3	Position 1	AP12652	Panel V2	Row 6	Position 4
AP11626	Panel Z1	Row 3	Position 2	AP12653	Panel W1	Row 1	Position 4
AP11628	Panel Z1	Row 4	Position 4	AP12655	Panel W1	Row 1	Position 3
AP11629	Panel Z1	Row 5	Position 1	AP12669	Panel Z1	Row 3	Position 4
AP11630	Panel Z1	Row 5	Position 2	AP12693	Panel X2	Row 4	Position 1
AP11631	Panel Z1	Row 5	Position 3	AP12731	Panel T1	Row 4	Position 4
AP11633	Panel X2	Row 5	Position 2	AP12737	Panel T2	Row 6	Position 4
AP11655	Panel Y1	Row 8	Position 2	AP12741	Panel X1	Row 8	Position 1
AP11671	Panel T2	Row 3	Position 1	AP12742	Panel X1	Row 8	Position 2
AP11672	Panel T2	Row 6	Position 1	AP12757	Panel U2	Row 1	Position 4
AP11678	Panel T2	Row 5	Position 4	AP12759	Panel T2	Row 1	Position 2
AP11679	Panel T1	Row 4	Position 1	AP12766	Panel T1	Row 5	Position 4
AP11691	Panel W1	Row 6	Position 4	AP12820	Panel X1	Row 5	Position 1
AP11699	Panel U1	Row 8	Position 1	AP12909	Panel T1	Row 8	Position 2
AP11705	Panel U1	Row 7	Position 4	AP12953	Panel X1	Row 2	Position 3
AP11706	Panel U1	Row 8	Position 3	AP12954	Panel X1	Row 2	Position 4
AP11719	Panel W2	Row 1	Position 1	AP12957	Panel X1	Row 3	Position 1
AP11721	Panel T1	Row 3	Position 2	AP12992	Panel T2	Row 3	Position 3
AP11746	Panel Z2	Row 6	Position 1	AP13004	Panel W1	Row 3	Position 1
AP11788	Panel X1	Row 3	Position 2	AP13007	Panel W1	Row 2	Position 2
AP11789	Panel X1	Row 3	Position 3	AP13008	Panel W1	Row 2	Position 4
AP11791	Panel X1	Row 3	Position 4	AP13009	Panel W1	Row 2	Position 3
AP11792	Panel X1	Row 4	Position 1	AP13010	Panel W1	Row 3	Position 2
AP11796	Panel T2	Row 7	Position 1	AP13014	Panel W1	Row 4	Position 1
AP11797	Panel T2	Row 4	Position 2	AP13016	Panel W1	Row 4	Position 2
AP11826	Panel Y1	Row 8	Position 3	AP13017	Panel W1	Row 4	Position 3
AP11855	Panel W1	Row 6	Position 1	AP13026	Panel X1	Row 4	Position 3
AP11863	Panel T2	Row 7	Position 3	AP13027	Panel X2	Row 7	Position 4
AP11914	Panel Y1	Row 6	Position 4	AP13225	Panel Z2	Row 1	Position 2
AP11922	Panel X1	Row 7	Position 4	AP13232	Panel W1	Row 4	Position 4
AP12060	Panel X1	Row 5	Position 2	AP13450	Panel W1	Row 7	Position 2
AP12065	Panel X2	Row 4	Position 4	AP13461	Panel T2	Row 6	Position 2
AP12066	Panel X2	Row 5	Position 1	AP13470	Panel T2	Row 2	Position 3
AP12067	Panel X2	Row 4	Position 2	AP13613	Panel X2	Row 5	Position 3
AP12095	Panel X2	Row 6	Position 4	AP13614	Panel X2	Row 6	Position 1
AP12127	Panel W2	Row 8	Position 4	AP13708	Panel X2	Row 7	Position 1
AP12134	Panel T2	Row 8	Position 2	AP13748	Panel V2	Row 1	Position 1

AuvecoPak AP448

Retail Merchandiser Contents

Sec. 15

Part Number Location Chart

Auveco Pak No.	Location			Auveco Pak No.	Location		
AP13750	Panel V2	Row 2	Position 2	AP15367	Panel T1	Row 3	Position 3
AP13751	Panel V2	Row 2	Position 1	AP15373	Panel X1	Row 8	Position 4
AP13752	Panel V2	Row 2	Position 4	AP15456	Panel T2	Row 1	Position 3
AP13753	Panel V2	Row 3	Position 1	AP15457	Panel T2	Row 1	Position 1
AP13755	Panel V2	Row 1	Position 2	AP15461	Panel T2	Row 5	Position 3
AP13932	Panel W1	Row 8	Position 1	AP15479	Panel T1	Row 8	Position 3
AP13933	Panel W1	Row 7	Position 4	AP15480	Panel T1	Row 7	Position 4
AP13960	Panel W1	Row 7	Position 3	AP15481	Panel T1	Row 7	Position 3
AP13993	Panel U2	Row 7	Position 4	AP15518	Panel Z2	Row 4	Position 2
AP13994	Panel V1	Row 2	Position 1	AP15543	Panel T1	Row 6	Position 1
AP13996	Panel U2	Row 7	Position 3	AP15677	Panel Z1	Row 1	Position 2
AP14010	Panel U2	Row 1	Position 3	AP15695	Panel Y2	Row 2	Position 4
AP14011	Panel U2	Row 1	Position 2	AP15711	Panel W2	Row 3	Position 4
AP14016	Panel U1	Row 6	Position 4	AP15752	Panel Z1	Row 8	Position 3
AP14019	Panel V1	Row 2	Position 3	AP15774	Panel X1	Row 4	Position 2
AP14020	Panel V1	Row 2	Position 4	AP15775	Panel X1	Row 8	Position 3
AP14021	Panel T1	Row 2	Position 4	AP15970	Panel T2	Row 3	Position 2
AP14023	Panel V2	Row 1	Position 3	AP15998	Panel T1	Row 8	Position 4
AP14032	Panel T1	Row 5	Position 2	AP16000	Panel V1	Row 4	Position 2
AP14036	Panel T1	Row 5	Position 3	AP16251	Panel W1	Row 3	Position 4
AP14127	Panel V2	Row 6	Position 3	AP16253	Panel W1	Row 3	Position 3
AP14163	Panel U1	Row 4	Position 4	AP16322	Panel Z1	Row 4	Position 2
AP14260	Panel V1	Row 3	Position 4	AP16323	Panel X1	Row 6	Position 3
AP14267	Panel W2	Row 3	Position 1	AP16421	Panel X2	Row 1	Position 2
AP14274	Panel W1	Row 8	Position 2	AP16622	Panel U2	Row 7	Position 2
AP14291	Panel U1	Row 2	Position 2	AP16695	Panel T2	Row 5	Position 2
AP14298	Panel Z2	Row 4	Position 3	AP16782	Panel U1	Row 7	Position 2
AP14313	Panel W1	Row 8	Position 3	AP16784	Panel U1	Row 7	Position 3
AP14328	Panel U1	Row 6	Position 1	AP16818	Panel T1	Row 4	Position 3
AP14355	Panel U1	Row 2	Position 1	AP16826	Panel Y1	Row 5	Position 3
AP14356	Panel U1	Row 1	Position 2	AP16834	Panel V2	Row 4	Position 1
AP14473	Panel Y1	Row 4	Position 4	AP16835	Panel V1	Row 7	Position 4
AP14546	Panel Z2	Row 5	Position 1	AP16842	Panel Z1	Row 4	Position 1
AP14547	Panel Z2	Row 5	Position 2	AP16846	Panel Z1	Row 3	Position 3
AP14550	Panel Y2	Row 8	Position 1	AP16858	Panel V1	Row 5	Position 2
AP14553	Panel Y2	Row 8	Position 2	AP16864	Panel V2	Row 5	Position 3
AP14559	Panel Y2	Row 7	Position 4	AP16936	Panel Y2	Row 8	Position 3
AP14642	Panel Y2	Row 4	Position 1	AP16937	Panel Y2	Row 8	Position 4
AP14695	Panel W2	Row 1	Position 3	AP16960	Panel Y1	Row 4	Position 3
AP14696	Panel V1	Row 3	Position 2	AP17004	Panel U1	Row 4	Position 3
AP14697	Panel V1	Row 3	Position 3	AP17006	Panel V2	Row 4	Position 3
AP14736	Panel U1	Row 2	Position 4	AP17034	Panel Y1	Row 6	Position 1
AP14737	Panel U1	Row 3	Position 1	AP17057	Panel V1	Row 6	Position 4
AP14738	Panel U1	Row 4	Position 2	AP17075	Panel T2	Row 4	Position 4
AP14750	Panel Z1	Row 5	Position 4	AP17098	Panel Y1	Row 3	Position 2
AP14753	Panel V1	Row 6	Position 2	AP17101	Panel V2	Row 2	Position 3
AP14921	Panel T1	Row 2	Position 3	AP17103	Panel U2	Row 7	Position 1
AP14992	Panel V1	Row 6	Position 1	AP17121	Panel V2	Row 5	Position 4
AP14994	Panel V1	Row 8	Position 2	AP17143	Panel V1	Row 7	Position 3
AP14997	Panel V1	Row 5	Position 1	AP17144	Panel V1	Row 8	Position 3
AP15042	Panel V1	Row 3	Position 1	AP17162	Panel U1	Row 7	Position 1
AP15044	Panel V1	Row 2	Position 2	AP17216	Panel V1	Row 1	Position 4
AP15170	Panel Y1	Row 5	Position 4	AP17222	Panel U2	Row 6	Position 3
AP15172	Panel X2	Row 7	Position 2	AP17267	Panel V1	Row 4	Position 4
AP15326	Panel W1	Row 5	Position 1	AP17315	Panel Y1	Row 5	Position 1
AP15335	Panel W1	Row 5	Position 3	AP17316	Panel Y1	Row 5	Position 2

Sec. 15

AuvecoPak AP448 Retail Merchandiser Contents

Part Number Location Chart

Auveco Pak No.	Location			Auveco Pak No.	Location		
AP17339	Panel U1	Row 5	Position 1	AP19655	Panel U1	Row 4	Position 1
AP17379	Panel V1	Row 4	Position 1	AP19682	Panel T2	Row 8	Position 3
AP17410	Panel V2	Row 6	Position 1	AP19721	Panel W2	Row 2	Position 4
AP17439	Panel V1	Row 5	Position 4	AP19729	Panel U1	Row 1	Position 3
AP17459	Panel X1	Row 5	Position 4	AP19739	Panel V1	Row 7	Position 2
AP17472	Panel V1	Row 6	Position 3	AP19756	Panel W2	Row 2	Position 2
AP17612	Panel T1	Row 3	Position 4	AP19757	Panel Y2	Row 4	Position 4
AP17615	Panel V2	Row 4	Position 2	AP19777	Panel Y1	Row 3	Position 4
AP17632	Panel V1	Row 4	Position 3	AP19800	Panel Y2	Row 4	Position 3
AP17639	Panel V2	Row 7	Position 1	AP19801	Panel U2	Row 6	Position 1
AP17649	Panel T2	Row 2	Position 1	AP19807	Panel Y2	Row 2	Position 1
AP17650	Panel X1	Row 4	Position 4	AP19821	Panel Y2	Row 6	Position 2
AP17664	Panel T1	Row 1	Position 4	AP19822	Panel Y2	Row 6	Position 1
AP17975	Panel U1	Row 3	Position 4	AP19837	Panel T1	Row 4	Position 2
AP17980	Panel Y1	Row 3	Position 3	AP20192	Panel T1	Row 2	Position 1
AP18033	Panel U1	Row 5	Position 4	AP20247	Panel U2	Row 4	Position 2
AP18108	Panel V2	Row 1	Position 4	AP20248	Panel U1	Row 8	Position 2
AP18114	Panel T2	Row 8	Position 4	AP20259	Panel X1	Row 6	Position 1
AP18119	Panel V1	Row 8	Position 1	AP20316	Panel T1	Row 6	Position 3
AP18153	Panel W1	Row 5	Position 4	AP20327	Panel U2	Row 5	Position 3
AP18167	Panel W1	Row 2	Position 1	AP20328	Panel Y2	Row 5	Position 3
AP18297	Panel U1	Row 2	Position 3	AP20335	Panel U2	Row 2	Position 1
AP18301	Panel T1	Row 5	Position 1	AP20348	Panel V1	Row 5	Position 3
AP18340	Panel X1	Row 5	Position 3	AP20349	Panel U2	Row 2	Position 4
AP18353	Panel U1	Row 8	Position 4	AP20362	Panel T1	Row 7	Position 1
AP18354	Panel X2	Row 1	Position 1	AP20366	Panel T1	Row 6	Position 2
AP18461	Panel V2	Row 4	Position 4	AP20377	Panel Y2	Row 5	Position 4
AP18842	Panel U1	Row 3	Position 3	AP20380	Panel Z2	Row 4	Position 4
AP18848	Panel T2	Row 2	Position 4	AP20390	Panel Y2	Row 3	Position 2
AP18873	Panel V1	Row 1	Position 1	AP20391	Panel Y2	Row 3	Position 3
AP18877	Panel U1	Row 5	Position 3	AP20397	Panel Z2	Row 5	Position 4
AP18888	Panel U2	Row 3	Position 4	AP20440	Panel W2	Row 2	Position 3
AP18915	Panel T2	Row 4	Position 1	AP20455	Panel X1	Row 6	Position 2
AP18930	Panel T2	Row 4	Position 3	AP20458	Panel U2	Row 8	Position 2
AP19113	Panel U1	Row 3	Position 2	AP20543	Panel U1	Row 1	Position 4
AP19114	Panel U1	Row 1	Position 1	AP20564	Panel U2	Row 5	Position 4
AP19118	Panel U2	Row 3	Position 2	AP20607	Panel Y2	Row 5	Position 1
AP19140	Panel V1	Row 7	Position 1	AP20627	Panel V2	Row 3	Position 3
AP19171	Panel U1	Row 5	Position 2	AP20629	Panel V2	Row 5	Position 1
AP19194	Panel W2	Row 2	Position 1	AP20632	Panel V1	Row 1	Position 2
AP19233	Panel U2	Row 5	Position 1	AP20687	Panel Y2	Row 3	Position 1
AP19239	Panel U2	Row 3	Position 1	AP20688	Panel Y2	Row 3	Position 4
AP19246	Panel U2	Row 5	Position 2	AP20741	Panel V2	Row 6	Position 2
AP19270	Panel T2	Row 5	Position 1	AP20757	Panel Z1	Row 7	Position 4
AP19274	Panel U2	Row 4	Position 1	AP20758	Panel Z1	Row 6	Position 4
AP19376	Panel V2	Row 5	Position 2	AP20774	Panel Y2	Row 5	Position 2
AP19378	Panel Y2	Row 2	Position 2	AP20788	Panel V2	Row 3	Position 2
AP19386	Panel T2	Row 3	Position 4	AP20834	Panel V2	Row 3	Position 4
AP19422	Panel V1	Row 1	Position 3	AP20869	Panel U2	Row 2	Position 2
AP19440	Panel Z2	Row 5	Position 3	AP20888	Panel U2	Row 6	Position 4
AP19453	Panel U2	Row 4	Position 4	AP20889	Panel U2	Row 8	Position 4
AP19613	Panel V1	Row 8	Position 4	AP20908	Panel U2	Row 2	Position 3
AP19614	Panel W2	Row 3	Position 2	AP20931	Panel U2	Row 8	Position 1
AP19615	Panel U2	Row 8	Position 3	AP20954	Panel W2	Row 1	Position 4
AP19626	Panel Y2	Row 1	Position 2	AP20955	Panel U2	Row 3	Position 3
AP19639	Panel U2	Row 6	Position 2	AP20986	Panel U2	Row 4	Position 3

BODY HARDWARE MASTER ASSORTMENTS

6000 & 6500 series Fix-Kits are listed on pages 343-363

Sec. 15

**A great introduction to prospective accounts or
an exciting new program to increase sales with existing customers**

Free Cabinet
when you buy
4 different assortments

The Most Popular
Body Hardware &
Specialty Fasteners



The Body Hardware Master Program, 6600BHM is based on Auveco's **DB-428 Display Boards**.

We have developed 20 large metal drawer assortments, which contain 428 of the most popular domestic and foreign body hardware clips and fasteners. Items come in heavy gauge steel, pre-labeled and pre-loaded large drawers and cabinets.

Each drawer is set up to accommodate the Auveco unit package quantity. No more problems with refills.

6650BHM: Buy a combination of any four different 6600BHM series individual drawer assortments and you'll receive one FREE 2-96 four drawer cabinet

Assortments Based on DB-428 Display Boards

Photos not actual size



6601BHM
Small Retainers &
Retaining Clips
24 Varieties, 840 Pieces

Contains the following
Auveco part numbers:
**10621, 11612, 11796, 12565,
12737, 12992, 13470, 14021, 14291,
14328, 14736, 14737, 15367, 15970,
17339, 18033, 18114, 18297, 18848,
18877, 19114, 19682, 19729 & 20543**



6603BHM
Hood Insulation Retainers,
Trim Panel Fasteners &
Rubber Vacuum Caps
16 Varieties, 440 Pieces

Contains the following
Auveco part numbers:
**4439, 4440, 11863, 11130, 12134, 12209,
12210, 12907, 12908, 14163, 15456,
19613, 19614, 19655, 20757 & 20758**



6602BHM
Large Retainers
22 Varieties, 965 Pieces

Contains the following
Auveco part numbers:
**10831, 12137, 12571, 12731, 12759,
12766, 12909, 14036, 14738, 15414,
15479, 15543, 15998, 16818, 17004,
17612, 17664, 17975, 19837, 20192,
20362 & 20366**



6604BHM
Push-Type Retainers
24 Varieties, 445 Pieces

Contains the following
Auveco part numbers:
**14260, 14753, 14992, 14997,
16000, 16858, 17057, 17143,
17144, 17267, 17379, 17472,
17632, 18119, 18888, 19118,
19239, 19739, 20335, 20348,
20349, 20869, 20908 & 20955**

Sec. 15

BODY HARDWARE MASTER ASSORTMENTS

Based on DB-428 Display Boards • *Photos not actual size*



6605BHM
Push-Type Retainers
24 Varieties, 492 Pieces

Contains the following
Auveco part numbers:
12757, 13993, 13996, 14010,
14019, 14020, 17216, 17222,
18873, 19233, 19246, 19274,
19422, 19453, 19615, 19639,
19801, 20247, 20327,
20564, 20632, 20889,
20931 & 20986



6606BHM
Push-Type Retainers,
Nylon Rivets
& Specialty Rivets
24 Varieties, 680 Pieces

Contains the following
Auveco part numbers:
12567, 12652, 13748, 13750,
13751, 13753, 13755, 14011,
14023, 14127, 16834, 16864,
17006, 17121, 17410, 17615,
17639, 18108, 18167, 18353,
18461, 19376, 20629 & 20741

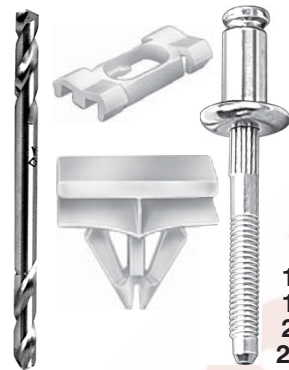

6607BHM
Specialty Rivets, Double End
Drill & Moulding Clips
24 Varieties, 925 Pieces

Contains the following
Auveco part numbers:
8301, 8311, 8313, 8925,
8931, 12653, 12655, 12658,
12676, 14642, 16837, 16838,
19757, 19821, 19822, 20328,
20377, 20523, 20607, 20626,
20627, 20774, 20788 & 20834



6608BHM
Moulding Clips & Fasteners,
Plug Buttons &
Wire Loom Clips
22 Varieties, 840 Pieces

Contains the following
Auveco part numbers:
2619, 2744, 2752, 8941,
9288, 9633, 9749, 9965,
11746, 14545, 14546,
14547, 19378, 19626, 19807,
20390, 20391, 20392, 20397,
20429, 20687 & 20688



6609BHM
Phillips Oval Head, Phillips Pan
Head & Specialty Tapping Screws
(Chrome & Zinc)
24 Varieties, 2400 Pieces

Contains the following
Auveco part numbers:
1423, 1483, 1717, 1794, 1796, 1799, 1940, 1943,
2027, 2365, 2366, 2367, 2710, 2713, 2728, 2730,
2731, 3079, 3090, 9603, 9605, 12095, 15172 & 19777



6610BHM
Phillips Oval Head Sems® (Chrome
& Black Phosphate) & Hex Washer
Head (Zinc and Zinc & Yellow)
Tapping Screws
24 Varieties, 1825 Pieces

Contains the following
Auveco part numbers:
2751, 2772, 2773, 2775, 3466, 3467, 9611, 9615,
11369, 11450, 11451, 11455, 11456, 11788, 11789,
11790, 11791, 11792, 11914, 15170, 16828,
16960, 17098 & 17980



6611BHM
Phillips Oval Head (Black Oxide),
Phillips Pan Head (Black Oxide) &
Specialty Tapping Screws
(Black E-Coat)
24 Varieties, 2175 Pieces

Contains the following Auveco part numbers:
10162, 10164, 10165, 10166, 10167, 10168, 10180,
10181, 10182, 11086, 11087, 11088, 11089, 11917,
11921, 11922, 11923, 12796, 12797, 12799,
12820, 12957, 16323 & 20259



6612BHM
Phillips Flat Top Washer Head (Black),
Hex Head Sems® (Black) &
Hex Slotted Head (Black)
Tapping Screws
23 Varieties, 1750 Pieces

Contains the following
Auveco part numbers:
12060, 12213, 12214, 12215, 12216, 12217, 12218,
12339, 12351, 12738, 12742, 12953, 12954, 13026,
15373, 15774, 15775, 16421, 17459, 17650,
18340, 18354 & 20455



6613BHM
Hex Head Sems & Hex Washer
Head Body Bolts (Black)
21 Varieties, 810 Pieces

Contains the following
Auveco part numbers:
9480, 10362, 10823, 11109,
11110, 11320, 11641, 12065,
12066, 12160, 12232, 12324, 12336,
12343, 12693, 13613, 13614, 13618,
13619, 18416 & 18769

BODY HARDWARE MASTER ASSORTMENTS

Based on DB-428 Display Boards • *Photos not actual size*

Sec. 15



6614BHM
Hex Head Sems® & Hex Washer Head Body Bolts (Zinc), Bumper Bolts & Specialty Fasteners
12 Varieties, 445 Pieces

Contains the following Auveco part numbers:
4474, 5242, 5246, 8443, 11295, 12335, 14473, 14976, 16826, 17316, 18262 & 19339



6619BHM
Nylon Nuts & Screw Grommets
23 Varieties, 860 Pieces

Contains the following Auveco part numbers:
3682, 8435, 9829, 9862, 11368, 11691, 11719, 13450, 13932, 13933, 13960, 14031, 14267, 14268, 14274, 14275, 14695, 18153, 19194, 19721, 19756, 20440 & 20954



6615BHM
Spin Lock Nuts, Hex Flange Nuts, Free Spinning Washer Nuts, Jack Nuts & Well Nuts
23 Varieties, 705 Pieces

Contains the following Auveco part numbers:
11644, 11645, 12595, 12596, 12995, 12999, 13004, 13007, 13008, 13009, 13010, 13014, 13016, 14855, 15326, 15329, 15334, 15335, 16470, 16769, 16830, 16883 & 20415



6620BHM
Door Hinge Pins & Bushings, Headlight Hardware, Door Lock Rod Clips, Window Crank Handle Retainer Clips & Cable Straps
14 Varieties, 336 Pieces

Contains the following Auveco part numbers:
2288, 3178, 11243, 14298, 14550, 14553, 14559, 15518, 15940, 16936, 16937, 19424, 19781 & 20380



6616BHM
J-Nuts, Spring Type U-Nuts & Extruded U-Nuts
23 Varieties, 965 Pieces

Contains the following Auveco part numbers:
5586, 5589, 8359, 8814, 9879, 9880, 10051, 10053, 10054, 10055, 10064, 10065, 10066, 10067, 11628, 11629, 11630, 11631, 12575, 12669, 14750, 15677 & 15752

6649BHM
Small Size • Grade 5 USS • Cap Screws, Nuts & Washers
12 Varieties, 150 Pieces

Auveco Part No.	Size
5434*	1/4"-20 x 1/2"
5436*	1/4"-20 x 3/4"
5438*	1/4"-20 x 1"
5449*	5/16"-18 x 3/4"
5451*	5/16"-18 x 1"
5452*	5/16"-18 x 1-1/4"
5453	5/16"-18 x 1-1/2"
5455	5/16"-18 x 2"
15586	1/4"-20 Hex Nut
15587	5/16"-18 Hex Nut
8606	1/4" USS Washer
8607	5/16" USS Washer

*Threaded to the head



6617BHM
Flat Nuts, U-Nuts, Tubular Nuts & Shims
11 Varieties, 950 Pieces

Contains the following Auveco part numbers:
1903, 2089, 2099, 2293, 2595, 3155, 3156, 5076, 5077, 5196 & 11292

6634BHM
Large Size • Metric Cap Screws, Nuts & Washers
12 Varieties, 380 Pieces

Auveco Part No.	Size
14430	M10-1.5 x 20mm
14431	M10-1.5 x 25mm
14432	M10-1.5 x 30mm
14433	M10-1.5 x 35mm
14434	M10-1.5 x 40mm
14436	M10-1.5 x 50mm
14438	M10-1.5 x 60mm
14439	M10-1.5 x 70mm
14441	M12-1.75 x 30mm
14442	M12-1.75 x 35mm
14443	M12-1.75 x 40mm
14445	M12-1.75 x 50mm
14454	M10-1.5 Hex Nut
14455	M12-1.75 Hex Nut
17395	10mm Flat Washer
10583	12mm Flat Washer



6618BHM
Washer Lock Nuts, Thread Cutting Nuts, Push-On Retainers & Pushnut Bolt Retainers
23 Varieties, 2300 Pieces

Contains the following Auveco part numbers:
2555, 2557, 2896, 2897, 3404, 3405, 8863, 8864, 8865, 8868, 8869, 9297, 9299, 10086, 10087, 10374, 10733, 12123, 12127, 12253, 12255, 12259 & 14980

Sec. 15

BODY HARDWARE MASTER ASSORTMENTS

Based on DB-428 Display Boards • *Photos not actual size*

6642BHM

Large Size • Grade 5 USS • Cap Screws, Nuts & Washers
8 Varieties, 650 Pieces



Auveco Part No.	Size
5463	3/8"-16 x 3/4
5465	3/8"-16 x 1"
5466	3/8"-16 x 1-1/4"
5467	3/8"-16 x 1-1/2"
5469	3/8"-16 x 2"
5471	3/8"-16 x 2-1/2"
5476	7/16"-14 x 1"
5477	7/16"-14 x 1-1/4
15588	3/8"-16 Hex Nut
15589	7/16"-14 Hex Nut
8608	3/8" USS Washer
8609	7/16" USS Washer

6629BHM

J.I.S. Hex Flange Bolts & Spin Lock Nuts
21 Varieties, 550 Pieces



Auveco Part No.	Size
17315	M6-1.0 x 12mm
17316	M6-1.0 x 16mm
18807	M6-1.0 x 20mm
21048	M6-1.0 x 25mm
18808	M6-1.0 x 30mm
18809	M6-1.0 x 40mm
18980	M8-1.25 x 12mm
17387	M8-1.25 x 16mm
17388	M8-1.25 x 20mm
21051	M8-1.25 x 25mm
17389	M8-1.25 x 30mm
21052	M8-1.25 x 35mm
17390	M8-1.25 x 40mm
21053	M8-1.25 x 45mm
17188	M10-1.25 x 16mm
17189	M10-1.25 x 20mm
21054	M10-1.25 x 25mm
17190	M10-1.25 x 30mm
21055	M10-1.25 x 35mm
17191	M10-1.25 x 40mm
21056	M10-1.25 x 45mm
16769	M6-1.0 Nut
16830	M8-1.25 Nut
16470	M10-1.25 Nut

6635BHM

Small Size • Metric Cap Screws, Nuts & Washers
14 Varieties, 925 Pieces



Auveco Part No.	Size
14403	M5-.8 x 16mm
14404	M5-.8 x 20mm
14407	M6-1.0 x 12mm
14408	M6-1.0 x 16mm
14409	M6-1.0 x 20mm
14410	M6-1.0 x 25mm
14411	M6-1.0 x 30mm
14419	M8-1.25 x 16mm
14420	M8-1.25 x 20mm
14421	M8-1.25 x 25mm
14422	M8-1.25 x 30mm
14423	M8-1.25 x 35mm
14424	M8-1.25 x 40mm
14426	M8-1.25 x 50mm
14449	M5-.8 Hex Nut
14450	M6-1.0 Hex Nut
14452	M8-1.25 Hex Nut
10578	5mm Flat Washer
17393	6mm Flat Washer
17394	8mm Flat Washer

6630BHM

Nylon Connectors & Rubber Vacuum Caps
24 Varieties, 310 Pieces

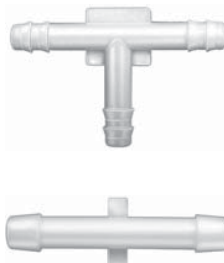

Auveco Part No.	Size	
Nylon Connectors		
12929	1/8" x 1/8"	Straight
12930	1/8" x 3/16"	Straight
12936	1/8" x 1/4"	Straight
12937	3/16" x 3/16"	Straight
12935	1/4" x 3/16"	Straight
12931	1/4" x 1/4"	Straight
12946	5/16" x 5/16"	Straight
12923	1/8" x 1/8" x 1/8"	Tee
12926	3/16" x 3/16" x 1/8"	Tee
12918	3/16" x 3/16" x 3/16"	Tee
12919	1/4" x 3/16" x 3/16"	Tee
11738	1/4" x 1/4" x 3/16"	Tee
17629	1/4" x 1/4" x 1/4"	Tee
12920	5/16" x 5/16" x 5/16"	Tee
12927	3/16" x 3/16" x 3/16"	Y
12943	1/4" x 1/4" x 1/4"	Y
12932	3/16" x 3/16"	Elbow
12939	3/16"	Cross

Rubber Caps



12209	For 1/8" O. D. Tube
4440	For 3/16" O. D. Tube
4439	For 1/4" O. D. Tube
12907	For 5/16" O. D. Tube
12210	For 3/8" O. D. Tube
12908	For 1/2" O. D. Tube

6631BHM

Krimp and Seal Terminals & Connectors
24 Varieties, 240 Pieces



Auveco Part No.	Description
13656	Ring Type, 22-18 Ga.
13657	Ring Type, 22-18 Ga.
13658	Spade Type, 22-18 Ga.
13659	Butt Conn., 22-18 Ga.
13660	Female Q. C., 22-18 Ga.
13661	Male Q. C., 22-18 Ga.
13662	Ring Type, 16-14 Ga.
13663	Ring Type, 16-14 Ga.
13664	Ring Type, 16-14 Ga.
13665	Ring Type, 16-14 Ga.
13666	Ring Type, 16-14 Ga.
13669	Butt Conn., 16-14 Ga.
13670	Female Q. C., 16-14 Ga.
13671	Male Q. C., 16-14 Ga.
13672	Female Q. C., 16-14 Ga.
13673	Male Q. C., 16-14 Ga.
13681	Female Plug, 16-14 Ga.
13682	Male Plug, 16-14 Ga.
13674	Ring Type, 12-10 Ga.
13675	Ring Type, 12-10 Ga.
13676	Ring Type, 12-10 Ga.
13678	Butt Conn., 12-10 Ga.
13679	Female Q. C., 12-10 Ga.
13680	Male Q. C., 12-10 Ga.

6699BHM

High Performance Imported
Miniature & Halogen Bulbs
71 Varieties, 494 Pieces



Contains Auveco Assortments
6643BHM, 6644BHM,
6645BHM,
1-924 24 Compartment Empty
Drawer and 2-96
Four Drawer Cabinet.

BODY HARDWARE MASTER ASSORTMENTS

Based on DB-428 Display Boards • *Photos not actual size*

Sec. 15



6643BHM

High Performance
Imported Miniature Bulbs
24 Varieties, 240 Pieces

Contain the following
Auveco Part Numbers:
**B24, B24A, B53, B57, B67,
B67A, B68, B89, B97, B168,
B194, B194A, B906, B906A,
B912, B916, B916A, B921,
B921A, B1141, B1156,
B1156A, B1157 & B1157A**



6644BHM

High Performance
Imported Miniature Bulbs
23 Varieties, 230 Pieces

Contain the following
Auveco Part Numbers:
**B1893, B1895, B2057,
B2057A, B2357, B2357A,
B3057, B3057A, B3156,
B3156A, B3157, B3157A,
B3357, B3357A, B3457,
B3457A, B4114K, B4157,
B4157K, B7440, B7440A,
B7443 & B7443A**



6645BHM

High Performance
Imported Halogen Bulbs
24 Varieties, 24 Pieces

Contain the following
Auveco Part Numbers:
**B880, B881, B884, B885,
B886, B889, B890, B891,
B893, B894, B896, B899,
B9004, B9005, B9006,
B9007, BH1, BH3, BH7, BH9,
BH10, BH11, BH13 & BD2C**



6641BHM

Cable Ties & Straps
10 Varieties, 575 Pieces

Auveco Part No.	Description
8550	2-1/4" Long, 7/16" Wide
14298	140mm Long, 8mm Wide
15144	4" Long, 3/32" Wide
15145	5-1/2" Long, 1/8" Wide
15146	7" Long, 3/16" Wide
15147	11" Long, 3/16" Wide
15148	14" Long, 5/16" Wide
15753	14" Long, 3/16" Wide
20380	200mm Long, 5mm Wide
21203	155mm Long, 5mm Wide



6628BHM

Oil Drain Plugs & Gaskets
24 Varieties, 105 Pieces

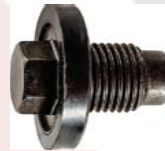

Auveco Part No.	Size
14196	1/2"-20
18373	1/2"-20
19130	1/2"-20
19365	1/2"-20, Magnetic
15527	M12-1.25
19588	M12-1.25
14677	M12-1.75
18023	M12-1.75
18374	M12-1.75
20347	M12-1.75
21047	M12-1.75
18024	M14-1.25
14678	M14-1.5
16308	M14-1.5
18025	M14-1.5
18375	M14-1.5
19141	M14-1.5
19279	M14-1.5
19620	M14-1.5 Single Oversize
19773	M14-1.5
20426	M14-1.5
15528	M16.4-1.33
15529	M18-1.5
15530	M20-1.5

6637BHM

Nylon Rivets
16 Varieties, 475 Pieces



Auveco Part No.	Size	Grip
20754	6mm	2.5mm-4.8mm
13746	3/16"	1/16"-9/64"
13747	13/64"	1/16"-11/64"
13748	13/64"	1/8"-15/64"
13755	13/64"	15/64"-25/64"
14004	15/64"	11/64"-11/32"
13752	17/64"	3/32"-3/16"
13753	17/64"	3/32"-3/16"
18502	1/4"	5/32"-1/4"
13750	1/4"	5/32"-13/32"
17101	1/4"	5/16"-15/32"
18108	1/4"	5/32"-3/8"
21028	1/4"	5/32"-3/8"
13751	1/4"	5/32"-13/32"
15490	9/32"	3/32"-15/64"
14023	15/64"	5/32"-5/16"

Sec. 15

BODY HARDWARE MASTER ASSORTMENTS

Based on DB-428 Display Boards • *Photos not actual size*

6633BHM

Metal Specialty Rivets
24 Varieties - 850 Pieces



Auveco Part No.	Size
1/8" (3.2mm) Diameter	
20788	Grip: 3/64" - 1/8"
20627	Grip: 3/64" - 3/16"
16834	Grip: 1/8" - 3/16"
8931	Grip: 3/16" - 1/4"
17615	Grip: 3/16" - 3/8"
5/32" (4mm) Diameter	
18461	Grip: 3/64" - 1/4"
20629	Grip: 3/64" - 1/4"
20971	Grip: 3/64" - 9/32"
19376	Grip: 1/8" - 11/32"
17006	Grip: 1/4" - 3/8"
3/16" (4.8mm) Diameter	
16864	Grip: 3/64" - 11/32"
20741	Grip: 3/64" - 23/64"
17121	Grip: 5/64" - 15/64"
8311	Grip: 1/8" - 1/4"
17410	Grip: 3/8" - 1/2"
14127	Grip: 3/8" - 1/2"
1/4" (6.4mm) Diameter	
16837	Grip: 1/32" - 9/64"
12653	Grip: 3/32" - 1/8"
18167	Grip: 3/32" - 9/64"
12652	Grip: 1/8" - 1/4"
12655	Grip: 9/64" - 3/16"
17639	Grip: 3/16" - 3/8"
8313	Grip: 1/4" - 3/8"
16838	Grip: 33/64" - 19/32"

6632BHM

GM, Ford & Chrysler
Push-Type Retainers
12 Varieties - 400 Pieces



Contains the following
Auveco part numbers:
17216, 20889, 20888, 20991,
20826, 20992, 20880, 20988,
20989, 20990, 20993 & 20994

6622BHM

BMW Clips & Fasteners
14 Varieties - 565 Pieces



Auveco Part No.	Description
13158	Moulding Clip
13162	U-Nut
13215	U-Nut
13216	U-Nut
13218	U-Nut
13223	U-Nut
18156	M4.8-1.59 x 16mm L.P. Screw
20186	Grommet
20234	Push-Type Retainer
20248	Push-Type Retainer
20253	Trim Panel Retainer
20270	Push-Type Retainer
20734	Push-Type Retainer
20754	Nylon Rivet

6624BHM

Honda & Acura
Push-Type Retainers
24 Varieties - 360 Pieces



Contains the following
Auveco part numbers:
14696, 14697, 16000, 16782,
17057, 17143, 17144, 17267,
17379, 18119, 19118, 19140,
19231, 19233, 19239, 19416,
19453, 20247, 20352, 20564,
20608, 20986, 21173 & 21297

6638BHM

GM Moulding Clips
24 Varieties - 415 Pieces



Contains the following
Auveco part numbers:
10617, 14642, 19757, 19800,
19820, 19821, 19822, 20280,
20318, 20328, 20353, 20377,
20607, 20756, 20774, 20808,
20865, 20884, 20934, 20952,
20972, 20976, 21128 &
21374

6623BHM

Honda & Acura
Retainers & Retaining Clips
24 Varieties - 595 Pieces



Contains the following
Auveco part numbers:
14289, 14291, 14328, 15998, 16775,
16776, 16779, 17205, 18114, 18294,
18746, 18877, 19114, 19116, 19145,
19171, 19470, 19506, 19682, 20334,
20609, 20610, 20882 & 21107

6639BHM

Hyundai & Kia
Clips & Fasteners
20 Varieties - 455 Pieces



Auveco Part No.	Description
20543	Hood Ins. Retainer
20566	Moulding Clip
20567	Moulding Clip
20568	Moulding Clip
20680	L. P. Screw
21064	Moulding Clip
21067	Bumper & Grille Retainer
21068	Nylon Nut
21070	Trim Panel Retainer
21136	Moulding Clip
21146	Push-Type Retainer
21188	Trim Panel Retainer
21244	Moulding Clip
21312	Moulding Clip
21321	Moulding Clip
21328	Push-Type Retainer
21360	Trim Panel Retainer
21378	Nylon U-Nut
21381	Hood Seal Retainer
21382	Cowl & Grille Retainer

BODY HARDWARE MASTER ASSORTMENTS

Based on DB-428 Display Boards • *Photos not actual size*

Sec. 15

6621BHM

Mercedes-Benz
Clips & Fasteners
24 Varieties - 665 Pieces



Auveco Part No.	Description
13215	U-Nut
13216	U-Nut
13218	U-Nut
13220	U-Nut
13223	U-Nut
13224	U-Nut
13230	Push-Type Retainer
16124	Tubular Type Nut
20187	Push-Type Retainer
20188	Trim Panel Retainer
20203	Push-Type Retainer
20205	Moulding Insert
20314	Push-Type Retainer
20636	Push-Type Retainer
20637	Push-Type Retainer
20638	Push-Type Retainer
20642	Door Panel Ret. Clip
20645	Carpet Retainer
20650	U-Nut
20735	Door Panel Retainer
20897	Moulding Clip
20909	Push-Type Retainer
20971	Rivet
21105	Hood Ins. Retainer

6625BHM

Nissan & Infiniti
Retainers & Push-Type Retainers
24 Varieties - 525 Pieces



Contains the following
Auveco part numbers:
14355, 14696, 14737, 16000,
16776, 16782, 16784, 16858, 16859,
17237, 17347, 17452, 17472, 18166, 18948,
19246, 19274, 19684, 20327, 20348,
20349, 20672, 20953 & 21192

6646BHM

Subaru
Clips & Fasteners
24 Varieties - 450 Pieces



Auveco Part No.	Description
21322	Panel Retainer
21420	Push-Type Retainer
21421	Hood Ins. Retainer
21422	Push-Type Retainer
21500	Push-Type Retainer
21501	Push-Type Retainer
21502	Panel Retainer
21530	Push-Type Retainer
21531	Cowl Panel Vent Cap
21563	Push-Type Retainer
21566	Push-Type Retainer
21570	Push-Type Retainer
21571	Push-Type Retainer
21572	Grille Clip
21574	Trim Retainer
21576	Push-Type Retainer
21580	Push-Type Retainer
21581	Moulding Clip
21584	Panel Retainer
21585	Push-Type Retainer
21591	Moulding Clip
21592	Push-Type Retainer
21593	Push-Type Retainer
21594	Push-Type Retainer

6640BHM

Volkswagen & Audi
Clips & Fasteners
24 Varieties - 595 Pieces



Auveco Part No.	Description
13173	Door Panel Clip
13475	Trim Panel Retainer
17006	Moulding Rivet
19195	Push-Type Retainer
20341	Trim Panel Retainer
20924	Screw Grommet
20925	Screw Grommet
21144	Trim Panel Retainer
21145	Hood Ins. Retainer
21251	Push-Type Retainer
21392	Cowl & Grille Retainer
21393	Trim Retainer
21394	Moulding Clip
21395	Moulding Clip
21396	Moulding Clip
21397	Moulding Clip Grommet
21398	Trim Panel Retainer
21399	Screw Grommet
21449	Moulding Clip
21478	Moulding Clip
21479	Push-Type Retainer
21512	Moulding Clip
21513	Push-On Retainer
21515	Fender & Bumper Retainer

6626BHM

Toyota & Lexus
Retainers & Retaining Clips
24 Varieties - 550 Pieces



Contains the following
Auveco part numbers:
14269, 14736, 14737, 14738, 15709, 18297, 18692,
18842, 18844, 18876, 18878, 19112, 19113, 19210,
19257, 19729, 19749, 19842, 20437, 20443,
20633, 20757, 20758 & 21102

6627BHM

Toyota & Lexus
Push-Type Retainers
24 Varieties - 316 Pieces



Contains the following
Auveco part numbers:
14260, 16784, 17162, 17439,
18270, 18873, 18888, 19140,
19416, 19552, 19739, 20335,
20349, 20577, 20869, 20908,
20931, 20955, 21010, 21011,
21103, 21123, 21201 & 21294

Sec. 15

BODY HARDWARE MASTER ASSORTMENTS

Based on DB-428 Display Boards • *Photos not actual size*

6647BHM

Mazda Clips & Fasteners
24 Varieties - 560 Pieces



Auveco Part No.	Description
14260	Push-Type Retainer
14274	Nylon Nut
14313	Nylon Nut
14367	Trim Panel Retainer
14695	Screw Grommet
14697	Push-Type Retainer
16000	Push-Type Retainer
16858	Push-Type Retainer
17632	Push-Type Retainer
18206	Push-Type Retainer
18458	Hood Insulation Clip
18692	Weatherstrip Retainer
18824	Trim Panel Retainer
19315	Push-Type Retainer
19481	Weatherstrip Retainer
19747	Push-Type Retainer
20465	Push-Type Retainer
20755	Push-Type Retainer
20923	Push-Type Retainer
20932	Trim Panel Retainer
20983	Trim Panel Retainer
21024	Push-Type Retainer
21171	Moulding Clip
21307	Retaining Clip

6648BHM

Mitsubishi Clips & Fasteners
24 Varieties - 520 Pieces



Auveco Part No.	Description
13932	Nylon Nut
14255	Nylon Nut
14275	Screw Grommet
14695	Screw Grommet
17195	Grille Clip
17351	Push-Type Retainer
17472	Push-Type Retainer
18951	Push-Type Retainer
19140	Push-Type Retainer
19239	Push-Type Retainer
19320	Retainer
19323	Retainer
19325	Retainer
19334	Retainer
19485	Nylon Nut
20247	Push-Type Retainer
20556	Tapping Screw
20557	Tapping Screw
20565	Grommet
20571	Retainer
20580	Push-Type Retainer
21118	Retainer
21140	Push-Type Retainer
21658	Push-Type Retainer

SMALL EMPTY DRAWERS AND CABINETS

Small cabinet and drawers with plastic inserts are made of sturdy heavy gauge steel. The kits are designed with scoop compartments and slide easily onto the cabinet slide. All items are available in unit packages. For refills, order by Auveco number on lid label.

Empty Drawers

(13-5/16" Wide x 9-1/4" Deep x 2" High)
With Locking Latch:

- 2-608: 8 Compartment
- 2-612: 12 Compartment
- 2-616: 16 Compartment
- 2-620: 20 Compartment
- 2-621: 21 Compartment
- 2-624: 24 Compartment



4-60

Empty Cabinet. Holds 4 Small Drawers.
15-1/4" Wide x 11-3/4" Deep x 11-1/4" High
Finish: Light Green Enamel
Drawer Size: 13-5/16" Wide x 9-1/4" Deep x 2" High



6-60

Cabinet & 6 Empty Small Drawers
24 Compartment Drawers with Locking Latches
15-1/4" W x 11-3/4" D x 16-3/8" H
Finish: Light Green Enamel
Drawer Size: 13-5/16" Wide x 9-1/4" Deep x 2" High

3-60

Empty Cabinet. Holds 6 Small Drawers

LARGE EMPTY DRAWERS AND CABINETS

Photos not actual size

Sec. 15



3-96

Empty Cabinet. Holds 2 Large Drawers.
20" Wide x 15-3/4" Deep x 8" High
Finish: Light Green Enamel
Drawer Size: 18" Wide x 12" Deep x 3" High



4-96

Cabinet & 4 Empty Large Drawers
24 Compartment Drawers with Locking Latches
20" Wide x 15-3/4" Deep x 14-1/2" High
Finish: Light Green Enamel
Drawer Size: 18" Wide x 12" Deep x 3" High

2-96

Empty Cabinet. Holds 4 Large Drawers
Base B-3 for cabinets 3-96, 4-96 and 2-96 is pictured on page 352



1-900
Steel with Locking Latch

18 x 12 x 3
Adjustable
Compartment
Empty Drawer with
3 Vertical &
3 Horizontal
Dividers

UNIT PACKAGE: 1

Empty Drawers
(18" Wide x 12" Deep x 3" High)
With Locking Latches:
1-912: 12 Compartment
1-916: 16 Compartment
1-920: 20 Compartment
1-924: 24 Compartment
1-932: 32 Compartment



Empty Plastic Tray Inserts

1-916INSERT: 16 Compartment for Drawer 1-916
1-920INSERT: 20 Compartment for Drawer 1-920
1-924INSERT: 24 Compartment for Drawer 1-924

UNIT PACKAGE: 1 case per insert
Only available in Master Case of 4 - Not sold separately.



1-901
Steel with Locking Latch

18 x 12 x 3
Adjustable
Compartment
Empty Drawer
with 9 dividers

UNIT PACKAGE: 1



1-901 DIVIDERS

2-15/16" x 4-5/16"
Divider
for 1-901 Drawer



1-902
Steel with Locking Latch

18 x 12 x 3
Adjustable
Compartment
Empty Drawer with
6 fixed horizontal
compartments and
12 movable
dividers adjustable
on 1" centers.

UNIT PACKAGE: 1

Sec. 15

FIX-IT LID LABELS & CABINETS

Photos not actual size

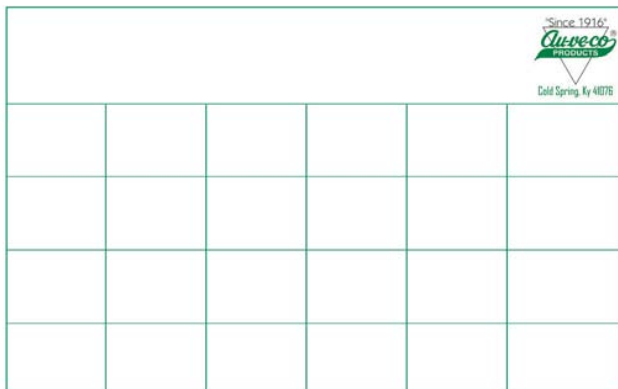

Printed lid labels in 12, 16, 20 and 24 compartment layouts (small and large drawer sizes). Same size and layout as Fix-Kit lid labels. Labels have a peel-away liner and self-adhesive backing for permanent adhesion.

Large Drawer Lid Labels

1-900L

Assortment of 1 each of 1-912L, 1-916L, 1-920L & 1-924L.

UNIT PACKAGE: 1 Set

1-912L

Large Drawer 12 Compartment Lid Label

UNIT PACKAGE: 5

1-916L

Large Drawer 16 Compartment Lid Label

UNIT PACKAGE: 5

1-920L

Large Drawer 20 Compartment Lid Label

UNIT PACKAGE: 5

1-924L

Large Drawer 24 Compartment Lid Label

UNIT PACKAGE: 5

Small Drawer Lid Labels

2-600L

Assortment of 1 each of 2-612L, 2-616L, 2-620L & 2-624L

UNIT PACKAGE: 1 Set

2-612L

Small Drawer 12 Compartment Lid Label

UNIT PACKAGE: 5

2-616L

Small Drawer 16 Compartment Lid Label

UNIT PACKAGE: 5

2-620L

Small Drawer 20 Compartment Lid Label

UNIT PACKAGE: 5

2-624L

Small Drawer 24 Compartment Lid Label

UNIT PACKAGE: 5



1-MBC

Miniature Bulb Cabinet

19" Wide x 4" Deep x 26-3/4" High
Ideal for the storage and organization of automotive miniature bulbs, fuses, etc. Features 4 durable plastic tilt-out trays with 28 adjustable dividers allowing for the creation of 4 to 32 compartments. Back-up storage shelves are located behind the hinged cover. Can be hung on wall using keyholes punched in the back. Constructed of prime cold rolled steel with gray powder coat finish.

Can be shipped via UPS



1-HTWD

Hose, Tubing and Wire Dispenser

19-9/16" Wide x 7-1/2" Deep x 11-15/16" High (front), 13-3/32" High (back)
Holds up to 6 reels of hose, tubing or wire. 1" diameter grommets in the front assure smooth, tangle free dispensing. Can be hung on wall using keyholes punched in the back. Constructed of prime cold rolled steel with gray powder coat finish.

Can be shipped via UPS

RACKS

Photos not actual size



1-WSR
Wire Spool Rack

26-1/8" Wide x 6" Deep x 37-1/8" High
Four sturdy steel rods provide secure and convenient storage for reels as large as 11" in diameter. Heavy duty steel with enamel finish. Does not include wire. Weight: 20 lbs.

Can be shipped via UPS



2-WSR
Wire Spool Rack

26" Wide x 5-3/4" Deep x 18" High
Two sturdy steel rods for storing and dispensing spools of wire. May be counter, wall or vehicle mounted. Shipping Weight 15 lbs.

Can be shipped via UPS



1-TR
Threaded Rod Rack

24" Wide x 6-7/8" Deep x 24-3/8" High
Separates and protects threaded rods, in 18 separate compartments, 2-1/8" (54.0mm) in diameter. Does not include threaded rod stock. Heavy duty steel with enamel finish. Weight: 14 lbs.

Can be shipped via UPS

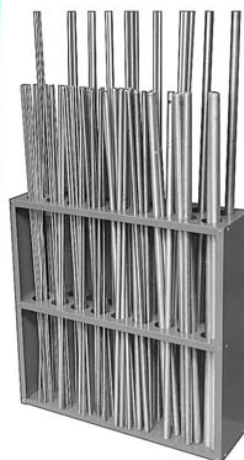

Sec. 15

RACKS AND BINS

Photos not actual size

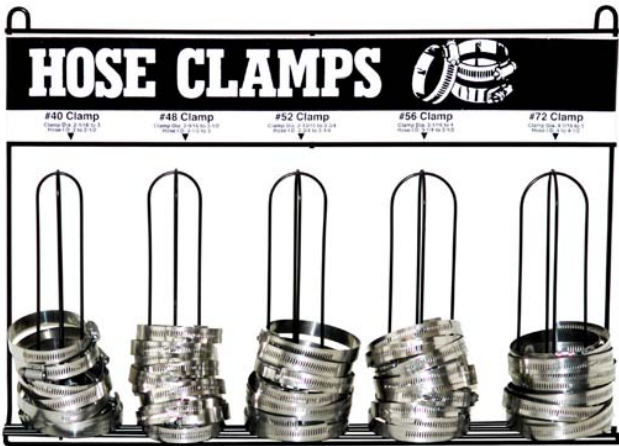

5-HCR

5 Loop Hose Clamp Rack

23-1/4" Wide x 5-3/8" Deep x 16-1/8" High
 Holds 5 sizes of clamp diameters: #40 (2-1/16" to 3"),
 #48 (2-9/16" to 3-1/2"), #52 (2-13/16" to 3-3/4"),
 #56 (3-1/16" to 4") and #72 (4-1/16" - 5").

Can be set on counter top or hung on a wall using the built-in hanger loops. Durable black powder coat finish with black and white sign panel.

Can be shipped via UPS

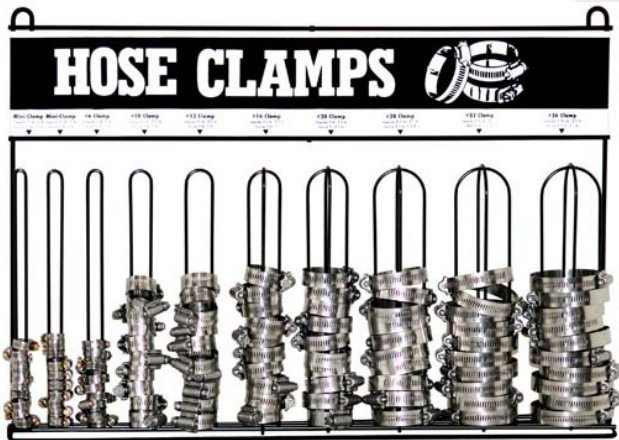

10-HCR

10 Loop Hose Clamp Rack

23-1/4" Wide x 5-3/8" Deep x 16-1/8" High
 Holds 10 sizes of clamp diameters:
 Mini-clamp (7/32" - 5/8"), Mini-clamp (5/16" - 7/8"),
 #6 (3/8" to 7/8"), #10 (9/16" to 1-1/16"),
 #12 (9/16" to 1-1/4"), #16 (11/16" to 1-1/2"),
 #20 (3/4" to 1-3/4"), #28 (1-5/16" to 2-1/4"),
 #32 (1-9/16" to 2-1/2") and #36 (1-13/16" to 2-3/4").

Can be set on counter top or hung on a wall using the built-in hanger loops. Durable black powder coat finish with black and white sign panel.

Can be shipped via UPS



P277

40 Compartment Bin

33-3/4" Wide x 12" Deep x 24" High
 Color: green or gray enamel finish
 Packing: 1 set up unit per carton
 Shipping Weight: 47 lbs.

Can be shipped via UPS

P40-S

40 Compartment Bin

33-3/4" Wide x 9" Deep x 24" High
 Color: green enamel finish
 Packing: 1 set up unit per carton
 Shipping Weight: 38 lbs.

Can be shipped via UPS

72B-9

72 Compartment Bin

33-3/4" Wide x 9" Deep x 42" High
 Color: green enamel finish
 Packing: 1 set up in two cartons
 Shipping Weight: 75 lbs.
 (Sold as a set only)

Can be shipped via UPS

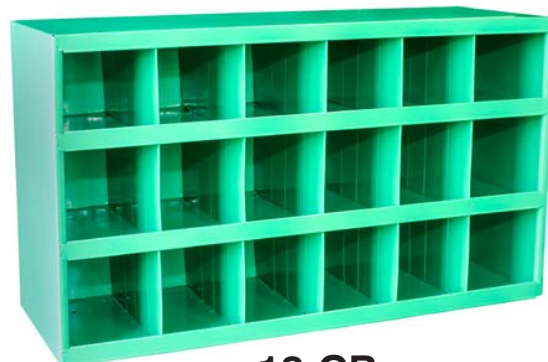

18-CB

18 Compartment Bin
 33-3/4" Wide x 12" Deep x 19-1/4" High
 Shipping Weight: 38 lbs.

Can be shipped via UPS

BINS, CABINETS AND ACCESSORIES

Photos not actual size

Sec. 15

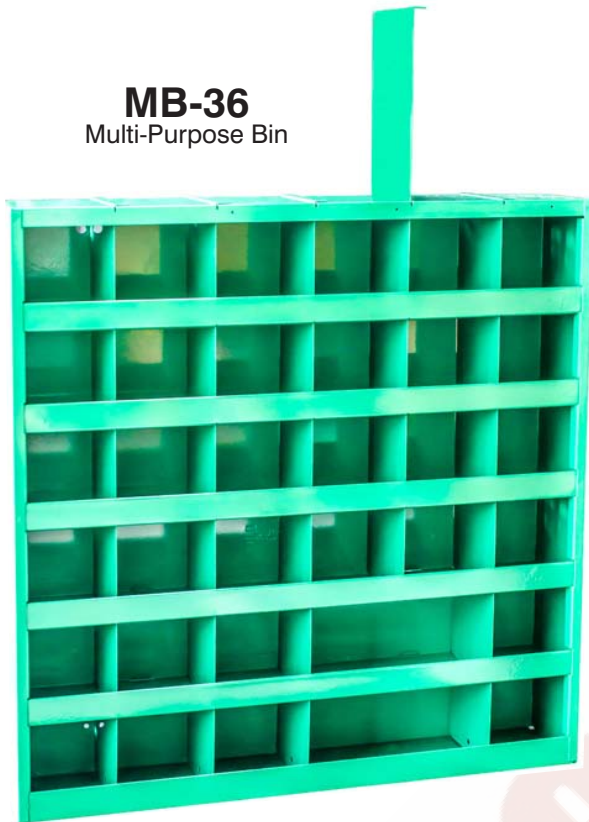

MB-36
Multi-Purpose Bin

23-5/8" Wide x 4-3/4" Deep x 23-5/8" High.
Removable vertical dividers allow the creation of double-width openings, each with scoops.
Keyhole slots are provided for wall mounting.
Shipping Weight: 25 lbs.

Can be shipped via UPS

Bin Bases

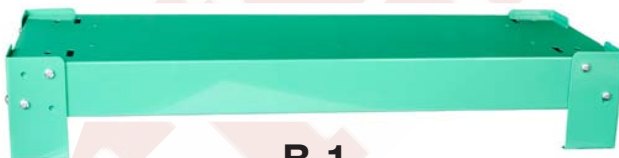

B-1
Base for Bins P277 & 18-D

Raises units 4 or 8 inches off the floor
Color: green enamel finish

UNIT PACKAGE: 1
Can be shipped via UPS

B-2
Base for Bin P40-S & 72B-9

Raises unit 4 or 8 inches off the floor
Color: green enamel finish

UNIT PACKAGE: 1
Can be shipped via UPS



18-D
18 Drawer Cabinet (with 36 Dividers)

34" Wide x 11-1/4" Deep x 11" High
Color: Green enamel finish
Shipping Weight: 47 lbs.

Can be shipped via UPS



9-D
9 Drawer Cabinet
(with 18 Dividers)

17-1/4" Wide x 11-5/8" Deep x 10-7/8" High
Shipping Weight 28 lbs.

Can be shipped via UPS



Dividers
For 18-D and 9-D

Plastic
2-1/2" x 5-3/16"

UNIT PACKAGE: 1



1-ACC
Aerosol Can Caddy

21-1/2" Wide x 3-1/8" Deep x 5-1/4" High
Holds 6 cans with a maximum can diameter of 3"
Holes are provided for wall mounting.

Does not include cans.
Shipping Weight: 2 lbs.

Can be shipped via UPS

Sec. 15

BIN LABELS

Photos not actual size

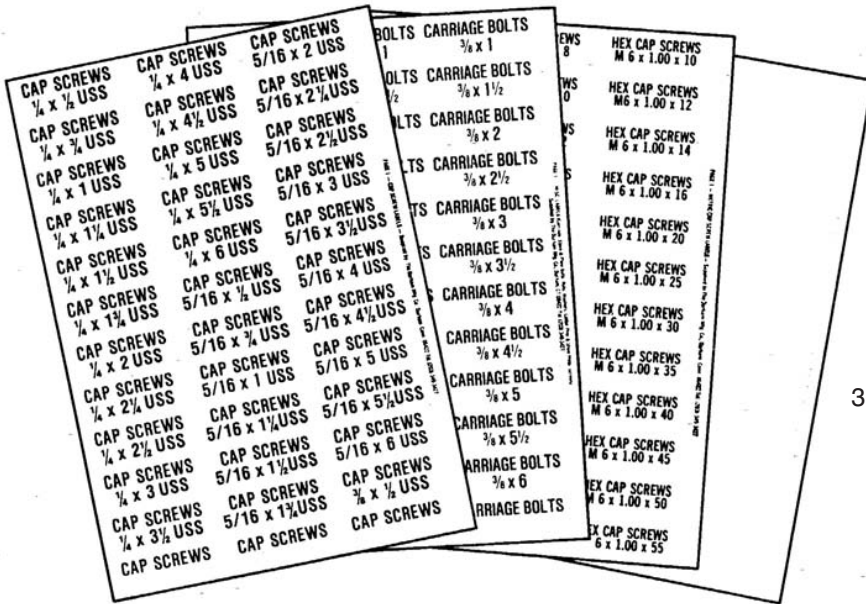

2" x 3/4" Pressure Sensitive Bin Labels Covering Popular Size U.S.S., S.A.E. and Metric Fasteners. 36 Labels per each 6-1/4" x 9" page.

15531

U.S.S. Fastener Labels for Cap Screws, Nuts, Lock Washers, Flat Washers and Blanks

Diameters: 1/4", 5/16", 3/8", 7/16", 1/2", 9/16", 5/8", 3/4", 7/8", & 1"
Lengths: 1/2" thru 6"
Total of 6 pages

UNIT PACKAGE: 1 Set

15532

S.A.E. Fastener Labels for Cap Screws, Nuts, Lock Washers, Flat Washers and Blanks

Diameters: 1/4", 5/16", 3/8", 7/16", 1/2", 9/16", 5/8", 3/4", 7/8", & 1"
Lengths: 1/2" thru 6"
Total of 6 pages

UNIT PACKAGE: 1 Set

15533

Bin Labels Assortment
Consists of 1 set each of 15531, 15532, 14774 & 14775

UNIT PACKAGE: 1 Set

14774

Metric Fastener Labels for Hex Cap Screws (Regular & Fine Thread), Hex Nuts, Nylon Insert Lock Nuts, Split Lock Washers, Flat Washers, Wave Washers, Socket Cap Screws and Socket Set Screws

Diameters: 4mm, 5mm, 6mm, 7mm, 8mm, 10mm, 12mm, 14mm, 16mm, 20mm & 24mm.
Total of 9 pages

UNIT PACKAGE: 1 Set

14775

Blank Labels
5 pages of labels to be written on with a ball point pen.

UNIT PACKAGE: 1 Set

DB-428L

Body Shop Bin Labels

Self-adhesive, pre-printed labels for 428 very popular Auveco body shop items. These labels are based on the contents of our DB-428 Display Boards, which are the items that we recommend everyone stock.

Each label measures 2-13/16" x 1" and contains an Auveco part number, description, OEM number, photograph and unit package quantity. Included are 22 blank labels for future new items. There are 15 pages in one set.

UNIT PACKAGE: 1 Set



BODY SHOP BIN ASSORTMENTS

Photos not actual size

Sec. 15



Having the right part for the job is easy with our assortments for domestic and import vehicle applications. Each assortment contains 36 of the top selling retainers and clips along with a pre-labeled Auveco MB-36 bin.

This 36 compartment bin measures 23-5/8" wide x 4-3/4" deep x 23-5/8" high. In addition to showing the Auveco part number and bar code, the labels include O.E.M. numbers as well.

Can be shipped via UPS

Domestic Vehicle "Xmas Tree" & Push-Type Retainers

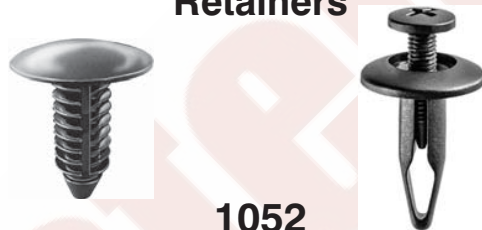

1052

1 box each (1,130 pieces) of the following parts and a MB-36 bin:

10831	12909	16818
11130	13993	17216
11146	13996	17222
11612	14010	17339
12137	14020	17612
12565	14021	17664
12567	14036	18033
12571	14753	18353
12731	14992	19422
12757	15456	19639
12759	15479	20192
12766	15543	20632

1053

Same as 1052 except without MB-36 bin.

Import Vehicle Retaining Clips, Push-Type Retainers & Screw Grommets



1054

1 box each (601 pieces) of the following parts and a MB-36 bin:

14260	18877	19729
14267	18888	20247
14737	19114	20327
16000	19118	20349
16858	19194	20380
17143	19233	20440
17379	19239	20564
17472	19246	20869
17632	19274	20908
18114	19453	20931
18297	19552	20955
18873	19721	20986

1055

Same as 1054 except without MB-36 bin.

Sec. 15

FASTENER CABINET ASSORTMENTS

Photos not actual size



Auveco offers one-price package assortments of popular U.S.S. and metric fasteners.

Each assortment contains one box each of 60 different fasteners that are all priced the same.

The assortments come in a sturdy, 5 shelf steel cabinet (15-1/2" x 32-1/2" x 4-1/4") that sits on a bench or can be wall mounted.

The assortments are shipped with the product already placed in the cabinet which is labeled with the fastener part numbers for easy re-stocking. Dimensions are clearly printed on the box labels to aid in quick selection of the proper part. All parts are available individually.

70000

U.S.S. Coarse Thread Fasteners

Contains one box each of the 60 numbers listed below. Includes cabinet.

Part No.	Size	U.P. Qty.	Part No.	Size	U.P. Qty.
GRADE 5 U.S.S. CAP SCREWS			U.S.S. HEX NUTS		
70100	1/4-20 x 1/2	27	70132	1/4-20	42
70101	1/4-20 x 3/4	23	70133	5/16-18	34
70102	1/4-20 x 1	20	70134	3/8-16	26
70103	1/4-20 x 1-1/4	17	70135	7/16-14	15
70104	1/4-20 x 1-1/2	14	70136	1/2-13	10
70105	1/4-20 x 2	10	LOCK WASHERS		
70106	5/16-18 x 3/4	17	70137	1/4"	100
70107	5/16-18 x 1	14	70138	5/16"	85
70108	5/16-18 x 1-1/4	11	70139	3/8"	50
70109	5/16-18 x 1-1/2	10	70140	7/16"	40
70110	5/16-18 x 1-3/4	9	70141	1/2"	23
70111	5/16-18 x 2	7	S.A.E. WASHERS		
70112	5/16-18 x 2-1/2	6	70142	1/4"	90
70113	5/16-18 x 3	5	70143	5/16"	80
70114	3/8-16 x 3/4	11	70144	3/8"	60
70115	3/8-16 x 1	10	70145	7/16"	50
70116	3/8-16 x 1-1/4	9	70146	1/2"	27
70117	3/8-16 x 1-1/2	7	U.S.S. WASHERS		
70118	3/8-16 x 1-3/4	7	70147	1/4"	80
70119	3/8-16 x 2	6	70148	5/16"	50
70120	3/8-16 x 2-1/4	6	70149	3/8"	40
70121	3/8-16 x 2-1/2	5	70150	7/16"	20
70122	3/8-16 x 3	4	70151	1/2"	15
70123	7/16-14 x 1	7	COTTER PINS		
70124	7/16-14 x 1-1/4	6	70152	1/16 x 1	125
70125	7/16-14 x 1-1/2	5	70153	3/32 x 1	100
70126	7/16-14 x 2	4	70154	3/32 x 1-1/2	80
70127	7/16-14 x 2-1/2	4	70155	1/8 x 1-1/2	50
70128	1/2-13 x 1-1/2	4	70156	1/8 x 2	35
70129	1/2-13 x 2	3	70157	5/32 x 1-1/2	30
70130	1/2-13 x 2-1/2	3	70158	5/32 x 2	25
70131	1/2-13 x 3	2	70159	3/16 x 2	20

71000

Metric Standard Pitch & Fine Pitch Fasteners

Contains one box each of the 60 numbers listed below. Includes cabinet.

Part No.	Size	U.P. Qty.	Part No.	Size	U.P. Qty.
STANDARD PITCH CAP SCREWS			LOCK WASHERS		
71101	M5-.80 x 12MM	25	71134	5MM	60
71102	M5-.80 x 25MM	20	71135	6MM	45
71103	M6-1.0 x 10MM	20	71136	8MM	25
71104	M6-1.0 x 12MM	20	71137	10MM	20
71105	M6-1.0 x 16MM	18	FLAT WASHERS		
71106	M6-1.0 x 20MM	17	71138	5MM	60
71107	M6-1.0 x 25MM	16	71139	6MM	50
71108	M6-1.0 x 30MM	14	71140	8MM	42
71109	M6-1.0 x 40MM	13	71141	10MM	24
71110	M6-1.0 x 45MM	11	COTTER PINS		
71111	M8-1.25 x 12MM	12	71142	2MM x 20MM	82
71112	M8-1.25 x 16MM	12	71143	3MM x 25MM	60
71113	M8-1.25 x 20MM	12	71144	5MM x 45MM	20
71114	M8-1.25 x 25MM	11	STUDS		
71115	M8-1.25 x 30MM	10	71145	M8-1.25 x 35MM	3
71116	M8-1.25 x 35MM	9	71146	M8-1.25 x 45MM	3
71117	M8-1.25 x 40MM	8	FINE PITCH CAP SCREWS		
71118	M8-1.25 x 45MM	7	71147	M8-1.0 x 40MM	6
71119	M8-1.25 x 50MM	7	71148	M8-1.0 x 50MM	5
71120	M8-1.25 x 60MM	6	71149	M10-1.0 x 30MM	4
71121	M8-1.25 x 75MM	5	71150	M10-1.0 x 50MM	3
71122	M10-1.5 x 20MM	6	71151	M10-1.25 x 20MM	5
71123	M10-1.5 x 25MM	6	71152	M10-1.25 x 25MM	4
71124	M10-1.5 x 30MM	5	71153	M10-1.25 x 30MM	4
71125	M10-1.5 x 35MM	5	71154	M10-1.25 x 35MM	4
71126	M10-1.5 x 40MM	5	71155	M10-1.25 x 40MM	3
71127	M10-1.5 x 50MM	4	71156	M10-1.25 x 50MM	3
71128	M10-1.5 x 60MM	4	71157	M10-1.25 x 60MM	2
71129	M10-1.5 x 70MM	3	FINE PITCH HEX NUTS		
STANDARD PITCH HEX NUTS			71158	M8-1.00	17
71130	M5-.80	41	71159	M10-1.00	12
71131	M6-1.0	25	71160	M10-1.25	9
71132	M8-1.25	17			
71133	M10-1.5	15			

FASTENER ASSORTMENTS

Photos not actual size

Sec. 15



Bin P40-S

Each assortment includes an Auveco 40 compartment bin P40-S (33-3/4" Wide x 9" Deep x 24" High). The reorder labels contain the fastener part number, size, description and bar code. All parts are certified to meet or exceed the proper S.A.E. specifications both physically and chemically.

Can be shipped via UPS

1020

Grade 5 U.S.S. (Coarse Thread) Fastener Assortment.

Over 2,800 pieces of Grade 5 U.S.S. cap screws, hex nuts, high alloy lock washers and high alloy S.A.E. flat washers.

Diameters: 1/4"-20, 5/16"-18, 3/8"-16, 7/16"-14 and 1/2"-13.

Lengths: 1/2" through 3".

All fasteners are zinc plated.

Refer to contents listing on next page.

1021

Same as 1020 except without P40-S bin. Includes planogram and reorder labels.

1030

Grade 8 U.S.S. (Coarse Thread) Fastener Assortment.

Over 2,000 pieces of Grade 8 U.S.S. cap screws, hex nuts, high alloy lock washers and high alloy S.A.E. flat washers.

Diameters: 1/4"-20, 5/16"-18, 3/8"-16, 7/16"-14, 1/2"-13 and 5/8"-11.

Lengths: 1/2" through 4".

All fasteners are zinc and yellow dichromate plated.

Refer to contents listing on next page.

1031

Same as 1030 except without P40-S bin. Includes planogram and reorder labels.

METRIC FASTENER ASSORTMENTS

1040

Metric Fastener (Regular Pitch) Assortment.

Over 1,200 metric cap screws, hex nuts, lock washers and flat washers.

Assortment comes with a pre-labeled Auveco 40 compartment bin, P40-S (33-3/4" Wide x 9" Deep x 24" High). The reorder labels contain the fastener part number, size, description and bar code.

Diameters: 6mm-1.00, 8mm-1.25, 10mm-1.50 and 12mm-1.75.

Lengths: 10mm through 50mm.

All fasteners are zinc plated.

Refer to contents listing on next page.

Can be shipped via UPS

1041

Same as 1040 except without P40-S Bin. Includes planogram and reorder labels.

1042

Metric Fastener (Regular & Fine Pitch) Assortment.

Over 1,995 metric cap screws, hex nuts, lock washers and flat washers.

Assortment comes with a pre-labeled Auveco 72 compartment bin, 72B-9, (33-3/4" wide x 9" deep x 42" high). The reorder labels contain the fastener part number, size, description and bar code.

Diameters: M5-.8, M6-1.0, M8-1.25, M8-1.0, M10-1.5, M10-1.25, M10-1.0 & M12-1.75.

Lengths: 10mm through 75mm.

All fasteners are zinc plated except fine pitch cap screws which have a black finish.

Refer to contents listing on following pages.

Can be shipped via UPS

1043

Same as 1042 except without 72-9 Bin. Includes planogram and reorder labels.

Sec. 15

FASTENER ASSORTMENTS CONTENTS

1020 & 1021

Grade 5 U.S.S. (Coarse Thread) Fastener Assortments. Contains 1 box each of:

5434	1/4"-20 x 1/2" Cap Screw	5480	7/16"-14 x 2" Cap Screw
5436	1/4"-20 x 3/4" Cap Screw	5488	1/2"-13 x 1-1/2" Cap Screw
5438	1/4"-20 x 1" Cap Screw	5490	1/2"-13 x 2" Cap Screw
5439	1/4"-20 x 1-1/4" Cap Screw	5491	1/2"-13 x 2-1/2" Cap Screw
5440	1/4"-20 x 1-1/2" Cap Screw	5492	1/2"-13 x 3" Cap Screw
5442	1/4"-20 x 2" Cap Screw	11925	1/4" High Alloy Lock Washer
5449	5/16"-18 x 3/4" Cap Screw	11926	5/16" High Alloy Lock Washer
5451	5/16"-18 x 1" Cap Screw	11927	3/8" High Alloy Lock Washer
5452	5/16"-18 x 1-1/4" Cap Screw	11928	7/16" High Alloy Lock Washer
5453	5/16"-18 x 1-1/2" Cap Screw	11929	1/2" High Alloy Lock Washer
5455	5/16"-18 x 2" Cap Screw	12781	1/4" High Strength SAE Washer
5463	3/8"-16 x 3/4" Cap Screw	12782	5/16" High Strength SAE Washer
5465	3/8"-16 x 1" Cap Screw	12783	3/8" High Strength SAE Washer
5466	3/8"-16 x 1-1/4" Cap Screw	12784	7/16" High Strength SAE Washer
5467	3/8"-16 x 1-1/2" Cap Screw	12785	1/2" High Strength SAE Washer
5468	3/8"-16 x 1-3/4" Cap Screw	15586	1/4"-20 Grade 5 Hex Nut
5469	3/8"-16 x 2" Cap Screw	15587	5/16"-18 Grade 5 Hex Nut
5471	3/8"-16 x 2-1/2" Cap Screw	15588	3/8"-16 Grade 5 Hex Nut
5476	7/16"-14 x 1" Cap Screw	15589	7/16"-14 Grade 5 Hex Nut
5478	7/16"-14 x 1-1/2" Cap Screw	15590	1/2"-13 Grade 5 Hex Nut

1030 & 1031

Grade 8 U.S.S. (Coarse Thread) Fastener Assortments. Contains 1 box each of:

9118	1/4"-20 x 1/2" Cap Screw	17499	5/8"-11 x 3-1/2" Cap Screw
9119	1/4"-20 x 3/4" Cap Screw	9164	5/8-11 x 4" Cap Screw
9120	1/4"-20 x 1" Cap Screw	11925	1/4" High Alloy Lock Washer
9122	1/4"-20 x 1-1/2" Cap Screw	11926	5/16" High Alloy Lock Washer
9128	5/16"-18 x 3/4" Cap Screw	11927	3/8" High Alloy Lock Washer
9129	5/16"-18 x 1" Cap Screw	11928	7/16" High Alloy Lock Washer
9131	5/16"-18 x 1-1/2" Cap Screw	11929	1/2" High Alloy Lock Washer
9137	3/8"-16 x 1" Cap Screw	11931	5/8" High Alloy Lock Washer
9138	3/8"-16 x 1-1/4" Cap Screw	12781	1/4" High Strength SAE Washer
9139	3/8"-16 x 1-1/2" Cap Screw	12782	5/16" High Strength SAE Washer
9140	3/8"-16 x 2" Cap Screw	12783	3/8" High Strength SAE Washer
9141	3/8"-16 x 2-1/2" Cap Screw	12784	7/16" High Strength SAE Washer
9146	7/16"-14 x 1-1/2" Cap Screw	12785	1/2" High Strength SAE Washer
9147	7/16"-14 x 2" Cap Screw	12787	5/8" High Strength SAE Washer
9153	1/2"-13 x 1-1/2" Cap Screw	15640	1/4"-20 Grade 8 Hex Nut
9155	1/2"-13 x 2" Cap Screw	15641	5/16"-18 Grade 8 Hex Nut
9156	1/2"-13 x 2-1/2" Cap Screw	15642	3/8"-16 Grade 8 Hex Nut
9157	1/2"-13 x 3" Cap Screw	15643	7/16"-14 Grade 8 Hex Nut
9161	5/8"-11 x 2" Cap Screw	15644	1/2"-13 Grade 8 Hex Nut
9163	5/8"-11 x 3" Cap Screw	15645	5/8"-11 Grade 8 Hex Nut

1040 & 1041

Metric Fastener (Regular Pitch) Assortments. Contains 1 box each of:

14584	6mm-1.00 x 10mm Cap Screw (DIN 933)	14434	10mm-1.50 x 40mm Cap Screw (DIN 931)
14407	6mm-1.00 x 12mm Cap Screw (DIN 933)	14435	10mm-1.50 x 45mm Cap Screw (DIN 931)
14408	6mm-1.00 x 16mm Cap Screw (DIN 933)	14436	10mm-1.50 x 50mm Cap Screw (DIN 931)
14409	6mm-1.00 x 20mm Cap Screw (DIN 933)	14440	12mm-1.75 x 25mm Cap Screw (DIN 933)
14410	6mm-1.00 x 25mm Cap Screw (DIN 933)	14441	12mm-1.75 x 30mm Cap Screw (DIN 933)
14411	6mm-1.00 x 30mm Cap Screw (DIN 931)	14442	12mm-1.75 x 35mm Cap Screw (DIN 933)
14412	6mm-1.00 x 35mm Cap Screw (DIN 931)	14443	12mm-1.75 x 40mm Cap Screw (DIN 933)
14413	6mm-1.00 x 40mm Cap Screw (DIN 931)	14445	12mm-1.75 x 50mm Cap Screw (DIN 931)
14419	8mm-1.25 x 16mm Cap Screw (DIN 933)	14450	6mm-1.00 Hex Nut (DIN 934)
14420	8mm-1.25 x 20mm Cap Screw (DIN 933)	14452	8mm-1.25 Hex Nut (DIN 934)
14421	8mm-1.25 x 25mm Cap Screw (DIN 933)	14454	10mm-1.50Hex Nut (DIN 934)
14422	8mm-1.25 x 30mm Cap Screw (DIN 933)	14455	12mm-1.75Hex Nut (DIN 934)
14423	8mm-1.25 x 35mm Cap Screw (DIN 931)	10579	6mm Flat Washer (DIN 125)
14424	8mm-1.25 x 40mm Cap Screw (DIN 931)	10581	8mm Flat Washer (DIN 125)
14425	8mm-1.25 x 45mm Cap Screw (DIN 931)	10582	10mm Flat Washer (DIN 125)
14426	8mm-1.25 x 50mm Cap Screw (DIN 931)	10583	12mm Flat Washer (DIN 125)
14430	10mm-1.50 x 20mm Cap Screw (DIN 933)	10586	6mm Lock Washer (DIN 127)
14431	10mm-1.50 x 25mm Cap Screw (DIN 933)	10588	8mm Lock Washer (DIN 127)
14432	10mm-1.50 x 30mm Cap Screw (DIN 933)	10589	10mm Lock Washer (DIN 127)
14433	10mm-1.50 x 35mm Cap Screw (DIN 933)	10590	12mm Lock Washer (DIN 127)

FASTENER ASSORTMENTS CONTENTS**Sec. 15****1042 & 1043**

Metric Fastener (Regular Pitch & Fine Pitch) Assortments. Contains 1 box each of:

Cap Screw			Hex Nut		
14583	5mm-.8 x 12mm	(DIN 933)	14449	5mm-.8	(DIN 934)
14403	5mm-.8 x 16mm	(DIN 933)	14450	6mm-1.0	(DIN 934)
14404	5mm-.8 x 20mm	(DIN 933)	14452	8mm-1.25	(DIN 934)
14405	5mm-.8 x 25mm	(DIN 933)	14454	10mm-1.5	(DIN 934)
14406	5mm-.8 x 30mm	(DIN 933)	14455	12mm-1.75	(DIN 934)
15512	5mm-.8 x 40mm	(DIN 933)			
14584	6mm-1.0 x 10mm	(DIN 933)	Flat Washer		
14407	6mm-1.0 x 12mm	(DIN 933)	10578	5mm	(DIN 125)
14408	6mm-1.0 x 16mm	(DIN 933)	10579	6mm	(DIN 125)
14409	6mm-1.0 x 20mm	(DIN 933)	10581	8mm	(DIN 125)
14410	6mm-1.0 x 25mm	(DIN 933)	10582	10mm	(DIN 125)
14411	6mm-1.0 x 30mm	(DIN 931)	10583	12mm	(DIN 125)
14412	6mm-1.0 x 35mm	(DIN 931)	Lock Washer		
14413	6mm-1.0 x 40mm	(DIN 931)	10585	5mm	(DIN 127)
14585	6mm-1.0 x 50mm	(DIN 931)	10586	6mm	(DIN 127)
14588	8mm-1.25 x 12mm	(DIN 933)	10588	8mm	(DIN 127)
14419	8mm-1.25 x 16mm	(DIN 933)	10589	10mm	(DIN 127)
14420	8mm-1.25 x 20mm	(DIN 933)	10590	12mm	(DIN 127)
14421	8mm-1.25 x 25mm	(DIN 933)	Fine Cap Screw		
14422	8mm-1.25 x 30mm	(DIN 933)	11257	8mm-1.0 x 25mm	(DIN 961)
14423	8mm-1.25 x 35mm	(DIN 931)	14604	8mm-1.0 x 50mm	(DIN 960)
14424	8mm-1.25 x 40mm	(DIN 931)	14605	10mm-1.25 x 20mm	(DIN 961)
14425	8mm-1.25 x 45mm	(DIN 931)	11265	10mm-1.25 x 25mm	(DIN 961)
14426	8mm-1.25 x 50mm	(DIN 931)	11266	10mm-1.25 x 30mm	(DIN 961)
14428	8mm-1.25 x 60mm	(DIN 931)	11267	10mm-1.25 x 35mm	(DIN 961)
14429	8mm-1.25 x 70mm	(DIN 933)	11268	10mm-1.25 x 40mm	(DIN 961)
14589	8mm-1.25 x 75mm	(DIN 931)	11269	10mm-1.25 x 50mm	(DIN 961)
14430	10mm-1.5 x 20mm	(DIN 933)	14606	10mm-1.25 x 60mm	(DIN 961)
14431	10mm-1.5 x 25mm	(DIN 933)	11262	10mm-1.0 x 30mm	(DIN 961)
14432	10mm-1.5 x 30mm	(DIN 933)	11264	10mm-1.0 x 50mm	(DIN 961)
14433	10mm-1.5 x 35mm	(DIN 933)	Fine Pitch Hex Nut		
14434	10mm-1.5 x 40mm	(DIN 931)	14453	8mm-1.0	(DIN 934)
14435	10mm-1.5 x 45mm	(DIN 931)	14457	10mm-1.25	(DIN 934)
14436	10mm-1.5 x 50mm	(DIN 931)	14456	10mm-1.0	(DIN 934)
14438	10mm-1.5 x 60mm	(DIN 931)			
14439	10mm-1.5 x 70mm	(DIN 931)			
14440	12mm-1.75 x 25mm	(DIN 933)			
14441	12mm-1.75 x 30mm	(DIN 933)			
14442	12mm-1.75 x 35mm	(DIN 933)			
14443	12mm-1.75 x 40mm	(DIN 933)			
14445	12mm-1.75 x 50mm	(DIN 931)			
14446	12mm-1.75 x 60mm	(DIN 931)			
14447	12mm-1.75 x 70mm	(DIN 931)			

Sec. 15

“6000” SERIES SMALL DRAWER FIX-KITS

Photos not actual size



Auveco offers more than 40 prepackaged Fix-Kits in the 6000 series small drawer. Each drawer measures 13-5/16” wide x 9-1/4” deep x 2” high.

Printed lid labels identify the correct Auveco part number for ordering refills.

“6000” Series Small Drawer Fix-Kit Numeric Listing

Refer to contents listing on following pages

Auveco Part No.	Description
6003	Phillips Oval Head Tapping Screws
6004	Special Tapping Screws
6007	Tubular, Flat, U & J-Nuts
6011	Round Head Machine Screws & Nuts
6038	Phillips Pan Head Tapping Screws
6043	Thread Cutting & Washer Lock Nuts
6051	Cotter Pins
6062	Plug Buttons
6065	Woodruff Keys
6070	Internal & External Lock Washers
6073	Socket Head Set Screws
6085	O-Rings
6086	Throttle Rod Clips & E-Clips
6112	Cotter Pins
6116	Internal & External Retaining Rings
6123	E-Rings
6124	Spring Pins
6125	Spring Pins

Auveco Part No.	Description
6128	Grease Fittings
6133	Insulated Closed Clamps
6144	Teks® Tapping Screws
6158	Metric Cotter Pins
6160	Metric Cap Screws & Nuts
6162	“Xmas Tree” Retainers
6164	Pushnut Bolt Retainers
6166	Body & Fender Shims
6167	Tee Connectors
6168	Hose Connectors
6172	Metric Pushnut Bolt & Push-On Retainers
6173	Solderless Terminals
6175	Solderless Terminals
6176	Thread Repair Inserts
6178	O.E.M. Electrical Terminals
6182	Phillips Washer Head Tapping Screws
6186	Oil Drain Plugs & Gaskets
6187	Metric Grease Fittings

“6000” Series/ “6500” Series Kit Cross Reference

The 6600 Series Body Hardware Master Assortments are listed on pages 324-331

6000 Kit	6500 Kit
6003	6501
6007	6502
6011	6503
6065	6504
6085	6505
6112	6506
6116	6507
6123	6058

6000 Kit	6500 Kit
6124	6509
6125	6510
6128	6511
6144	6536
6160	6513
6178	6543
6182	6530
6186	6534

"6000" SERIES SMALL DRAWER FIX-KITS

Photos not actual size

Sec. 15



6003 Fix-Kit

Phillips Oval Head Tapping Screws
Zinc & Chrome Plated
24 Varieties - 540 Pieces

Auveco Part No.	Size	Head
3069	#4 x 3/4"	
1793	#6 x 5/8"	
1794	#6 x 3/4"	
1796	#6 x 1"	
1797	#6 x 1-1/4"	
2024	#8 x 3/8"	No. 6
2358	#8 x 1/2"	
2027	#8 x 1/2"	No. 6
1421	#8 x 5/8"	No. 6
1799	#8 x 3/4"	No. 6
2359	#8 x 3/4"	
1801	#8 x 1"	No. 6
1802	#8 x 1-1/8"	No. 6
2361	#8 x 1-1/4"	
1803	#8 x 1-1/4"	No. 6
2362	#8 x 1-1/2"	
1932	#8 x 1-1/2"	No. 6
1933	#8 x 1-3/4"	No. 6
1717	#10 x 3/4"	No. 8
2728	#10 x 3/4"	
1804	#10 x 1"	No. 6
1807	#10 x 1-1/8"	
2046	#10 x 1-1/2"	No. 6
2665	#10 x 2"	No. 8



6038 Fix-Kit

Phillips Pan Head Tapping Screws
Zinc Plated
20 Varieties - 1385 Pieces

Auveco Part No.	Size
3071	#4 x 1/4"
3072	#4 x 3/8"
3073	#4 x 1/2"
3074	#4 x 3/4"
3075	#4 x 1"
1935	#6 x 1/4"
1936	#6 x 3/8"
1937	#6 x 1/2"
5621	#6 x 5/8"
2364	#6 x 3/4"
3076	#6 x 1"
3077	#6 x 1-1/4"
3078	#6 x 1-1/2"
1939	#8 x 3/8"
1940	#8 x 1/2"
5625	#8 x 5/8"
2365	#8 x 3/4"
3079	#8 x 1"
3080	#8 x 1-1/4"
3081	#8 x 1-1/2"



6004 Fix-Kit

Phillips Specialty Tapping Screws
Zinc Plated
24 Varieties - 795 Pieces



Auveco Part No.	Size	Head
1936	#6 x 3/8"	
1937	#6 x 1/2"	
2364	#6 x 3/4"	
1939	#8 x 3/8"	
10642	#8 x 3/8"	
2805	#8 x 7/16"	
1940	#8 x 1/2"	
12095	#8 x 1/2"	
14859	#8 x 1/2"	
15171	#8 x 1/2"	
15172	#8 x 1/2"	
1712	#8 x 3/4"	No. 6
2365	#8 x 3/4"	
3079	#8 x 1"	
2178	#10 x 3/8"	
1943	#10 x 1/2"	
2808	#10 x 5/8"	
13709	#10 x 3/4"	
2366	#10 x 3/4"	
3082	#10 x 1"	
2367	#12 x 3/4"	
3086	#12 x 1"	
3089	#14 x 1/2"	
3090	#14 x 3/4"	



6182 Fix-Kit

Phillips Flat Top Washer Head
Tapping Screws
Black E-Coat & Zinc Plated
12 Varieties - 1790 Pieces

Auveco Part No.	Size	Plating
12950	#6 x 1/2"	Black E-Coat
12951	#6 x 3/4"	Black E-Coat
12213	#8 x 1/2"	Black E-Coat
12214	#8 x 5/8"	Black E-Coat
12215	#8 x 3/4"	Black E-Coat
12216	#8 x 1"	Black E-Coat
12217	#8 x 1-1/4"	Black E-Coat
12218	#8 x 1-1/2"	Black E-Coat
12953	#10 x 3/4"	Black E-Coat
12954	#10 x 1"	Black E-Coat
14859	#8 x 1/2"	Zinc
14861	#8 x 3/4"	Zinc

Sec. 15

“6000” SERIES SMALL DRAWER FIX-KITS

Photos not actual size

6144 Fix-Kit

Teks® Self-Drilling Screws
Phillips Pan Head
Hex Washer Head
Zinc Plated
16 Sizes - 365 Pieces



Auveco Part No.	Size	Head
9605	#8 x 1/2"	Pan
9606	#8 x 3/4"	Pan
9607	#10 x 1/2"	Pan
9608	#10 x 3/4"	Pan
11905	#12 x 1"	Pan
9611	#8 x 1/2"	Hex
9612	#8 x 3/4"	Hex
9613	#10 x 1/2"	Hex
9614	#10 x 5/8"	Hex
9615	#10 x 3/4"	Hex
9616	#10 x 1"	Hex
11911	#12 x 1"	Hex
9620	#14 x 3/4"	Hex
11914	#14 x 1"	Hex
11915	#14 x 1-1/4"	Hex
11916	#14 x 1-1/2"	Hex

6011 Fix-Kit

Slotted Round Head
Machine Screws
Zinc Plated
19 Varieties of Screws
5 Varieties of Nuts - 1110 Pieces



Auveco Part No.	Size
Nut	
727	6-32
728	8-32
729	10-32
730	10-24
731	12-24
Screw	
2530	6-32 x 1/2"
2531	6-32 x 3/4"
2532	6-32 x 1"
2533	8-32 x 1/2"
2534	8-32 x 3/4"
2535	8-32 x 1"
2536	10-32 x 1/2"
2537	10-32 x 3/4"
2538	10-32 x 1"
2539	10-32 x 1-1/4"
2540	10-32 x 1-1/2"
2541	10-24 x 1/2"
2542	10-24 x 3/4"
2543	10-24 x 1"
2544	10-24 x 1-1/4"
2545	10-24 x 1-1/2"
2546	12-24 x 1/2"
2548	12-24 x 1"
2550	12-24 x 1-1/2"

6160 Fix-Kit

Metric Regular Pitch • DIN 933
Cap Screws & Nuts
Zinc Plated
12 Varieties of Screws
4 Varieties of Nuts - 236 Pieces



Auveco Part No.	Size
Screw	
14400	M4-.7 x 16mm
14401	M4-.7 x 20mm
14402	M5-.8 x 10mm
14403	M5-.8 x 16mm
14404	M5-.8 x 20mm
14405	M5-.8 x 25mm
14408	M6-1.0 x 16mm
14409	M6-1.0 x 20mm
14410	M6-1.0 x 25mm
14420	M8-1.25 x 20mm
14421	M8-1.25 x 25mm
14422	M8-1.25 x 30mm
Nut	
14448	M4-.7
14449	M5-.8
14450	M6-1.0
14452	M8-1.25

6073 Fix-Kit

Socket Head Set Screws
47 Varieties Screws - 540 Pieces



Auveco Part No.		Size
USS	SAE	
5366		6-32 x 1/4"
5367		6-32 x 5/16"
5368		6-32 x 3/8"
5370		8-32 x 1/4"
5371		8-32 x 5/16"
5372		8-32 x 3/8"
5373		8-32 x 1/2"
Auveco Part No.		Size
5374	5394	10 x 3/16"
5375	5395	10 x 1/4"
5376	5396	10 x 5/16"
5377	5397	10 x 3/8"
5378	5398	10 x 1/2"
5379	5399	1/4 x 1/4"
5380	5400	1/4 x 5/16"
5381	5401	1/4 x 3/8"
5382	5402	1/4 x 7/16"
5383	5403	1/4 x 1/2"
5384	5404	5/16 x 1/4"
5385	5405	5/16 x 5/16"
5386	5406	5/16 x 3/8"
5387	5407	5/16 x 7/16"
5388	5408	5/16 x 1/2"
5389	5409	3/8 x 5/16"
5390	5410	3/8 x 3/8"
5391	5411	3/8 x 7/16"
5392	5412	3/8 x 1/2"
5393	5413	3/8 x 5/8"

"6000" SERIES SMALL DRAWER FIX-KITS

Photos not actual size

Sec. 15



6007 Fix-Kit

Tubular, Flat, U & J Nuts
24 Varieties - 515 Pieces

Auveco Part No.	Size	Type
1903	1/4"-20	Flat
2089	#6-32	Flat
2092	#10-24	Flat
2099	1/8" Stud	Flat
2103	3/16" Stud	Flat
2105	1/4" Stud	Flat
2293	1/4"-20	U-Nut
2346	#8	J-Nut
2422	#10	U-Nut
2595	1/8" Stud	Tubular
2611	1/8" Stud	Tubular
5170	3/8"-16	J Cage
5197	#10-24	U-Nut
5586	1/4"-20	J Cage
5589	5/16"-18	J Cage
9879	#8	Spring U
9880	#8	Spring U
10064	#6	Spring U
10065	#8	Spring U
10066	#10	Spring U
10067	#14	Spring U
10666	#8	U-Nut
11292	#8	U-Nut
11429	#10	U-Nut



6070 Fix-Kit

Shakeproof
Lock Washers
(External,
Internal & Countersunk)
Zinc Plated
24 Varieties - 1450 Pieces



Auveco Part No.	Size	Type
5249	#4	External
5259	#4	Internal
5250	#6	External
5260	#6	Internal
5270	#6	Countersunk
5251	#8	External
5261	#8	Internal
5271	#8	Countersunk
5252	#10	External
5262	#10	Internal
5272	#10	Countersunk
5253	#12	External
5263	#12	Internal
5254	1/4"	External
5264	1/4"	Internal
5255	5/16"	External
5265	5/16"	Internal
5256	3/8"	External
5266	3/8"	Internal
5257	7/16"	External
5267	7/16"	Internal
5258	1/2"	External
5268	1/2"	Internal
5274	1/4"	Countersunk



6186 Fix-Kit

Oil Drain Plugs & Gaskets
12 Varieties - 80 Pieces

Auveco Part No.

Size

14196	1/2"-20
18373	1/2"-20
18121	1/2"-20
Double Oversize	
15527	M12-1.25
14677	M12-1.75
18374	M12-1.75
21047	M12-1.75
14678	M14-1.5
16308	M14-1.5
19279	M14-1.5
19773	M14-1.5
15529	M18-1.5



6043 Fix-Kit

Washer Lock Nuts
& Thread Cutting Nuts
16 Varieties - 1235 Pieces



Auveco Part No.

Size

2554	#6-32
2555	#8-32
2556	#10-32
2557	#10-24
2560	#12-24
2561	1/4"-20
2562	1/4"-20
2895	1/8" Stud
2896	3/16" Stud
2897	1/4" Stud
3403	1/8" Stud
3404	3/16" Stud
3405	1/4" Stud
8855	5/32" Stud
10733	5/16" Stud
12253	5mm Stud



6164 Fix-Kit

Pushnut Bolt Retainer
8 Sizes - 1350 Pieces

Auveco Part No.

For Bolt Diameter

16851	9/64" (#6)
10085	5/32" (#8)
16852	3/16" (#10)
10086	1/4"
10087	5/16"
9297	3/8"
9298	7/16"
9299	1/2"

Sec. 15

“6000” SERIES SMALL DRAWER FIX-KITS

Photos not actual size



6172 Fix-Kit

Metric Pushnut Bolt Retainers & Push-On Retainers
10 Sizes - 745 Pieces



Auveco Part No.	Bolt or Stud Size
12119	4.0mm Stud
12122	M5-.8
12123	M6-1.0
14980	M6-1.0
12124	M6.3-1.0
12125	M8-1.25
12259	M8-1.25
12126	M10-1.50
12260	M10-1.50
12127	M12-1.75



6086 Fix-Kit

Rod End Clips & E-Clips
16 Varieties - 560 Pieces

Auveco Part No.	Shaft Diameter	
Rod End Clips		
3609	5/32"	Right Side
3610	5/32"	Left Side
3611	3/16"	Right Side
3612	3/16"	Left Side
3613	1/4"	Right Side
3614	1/4"	Left Side
E-Clips		
3165	1/8"	
3166	3/16"	
3167	1/4"	
3824	5/16"	Small O.D.
3628	5/16"	Large O.D.
5600	3/8"	
2672	7/16"	
5602	1/2"	
5601	9/16"	
5603	5/8"	

FasTrack Web recently underwent a complete renovation.

One of it's newest features includes several pre-loaded kits used for collision repairs.

FasTrack is Auveco's body cost recovery system.

Go to www.auveco.com to learn more and start saving your body shop money



6123 Fix-Kit

E & Reinforced E-Rings
Groove Required
24 Varieties - 1500 Pieces



Auveco Part No.	Shaft Diameter	Type
8824	1/16"	E-Type
8825	3/32"	E-Type
8836	3/32"	Reinforced E
3165	1/8"	Reinforced E
8826	1/8"	E-Type
3166	3/16"	Reinforced E
8827	3/16"	E-Type
3167	1/4"	Reinforced E
8828	1/4"	E-Type
3628	5/16"	Reinforced E
3824	5/16"	E-Type
5600	3/8"	Reinforced E
8829	3/8"	E-Type
2672	7/16"	Reinforced E
8830	7/16"	E-Type
8837	1/2"	Reinforced E
5602	1/2"	E-Type
5601	9/16"	Reinforced E
5603	5/8"	E-Type
8831	3/4"	E-Type
8832	7/8"	E-Type
8833	1"	E-Type
8834	1-3/16"	E-Type
8835	1-3/8"	E-Type

6112 Fix-Kit

Hammer-lock Cotter Pins
Bright Zinc Chromate
16 Varieties - 1500 Pieces



Auveco Part No.	Size
8477	1/16" x 1/2"
8478	1/16" x 3/4"
8479	1/16" x 1"
8480	1/16" x 1-1/2"
8481	3/32" x 3/4"
8482	3/32" x 1"
8484	3/32" x 1-1/2"
8485	3/32" x 2"
8486	1/8" x 1"
8487	1/8" x 1-1/4"
8488	1/8" x 1-1/2"
8490	1/8" x 2"
8491	1/8" x 1-1/2"
8492	5/32" x 1"
8493	5/32" x 1-1/2"
8494	5/32" x 2"

"6000" SERIES SMALL DRAWER FIX-KITS

Photos not actual size

Sec. 15

6051 Fix-Kit

Hammer-lock Cotter Pins
Plain Steel
18 Varieties - 2790 Pieces

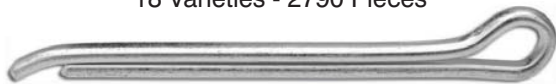

Auveco Part No.	Size
3502	1/16" x 1/2"
3503	1/16" x 3/4"
3504	1/16" x 1"
3505	1/16" x 1-1/4"
3506	1/16" x 1-1/2"
3508	1/16" x 2"
3509	3/32" x 1/2"
8481*	3/32" x 3/4"
3511	3/32" x 1"
3512	3/32" x 1-1/4"
3513	3/32" x 1-1/2"
3515	3/32" x 2"
3519	1/8" x 3/4"
3520	1/8" x 1"
3521	1/8" x 1-1/4"
3522	1/8" x 1-1/2"
8489*	1/8" x 1-3/4"
3524	1/8" x 2"

*Plated

6158 Fix-Kit

Metric Cotter Pins
12 Sizes - 580 Pieces



Auveco Part No.	Size
10553	2 x 18mm
10554	2 x 20mm
10556	2 x 25mm
10558	3 x 25mm
10559	3 x 30mm
10560	3 x 35mm
10562	4 x 30mm
10563	4 x 35mm
10564	4 x 40mm
10566	5 x 35mm
10567	5 x 40mm
10568	5 x 45mm



6116 Fix-Kit

Basic Internal & External Rings
Zinc Plated
24 Varieties - 1000 Pieces



Auveco Part No.	Shaft Diameter
Internal Type	
8688	1/4"
8689	5/16"
8690	3/8"
8691	7/16"
8692	1/2"
8693	9/16"
8694	5/8"
8695	3/4"
8696	7/8"
8697	1"
8698	1-1/8"
8699	1-1/4"
External Type	
8701	1/4"
8702	5/16"
8703	3/8"
8704	7/16"
8705	1/2"
8706	9/16"
8707	5/8"
8708	3/4"
8709	7/8"
8710	1"
8711	1-1/8"
8712	1-1/4"



6085 Fix-Kit

Rubber O-Rings
20 Varieties - 300 Pieces

Auveco Part No.	Inside Diameter	Outside Diameter
4305	1/8"	1/4"
4306	5/32"	9/32"
4307	3/16"	5/16"
4308	7/32"	11/32"
4309	1/4"	3/8"
4310	5/16"	7/16"
4311	3/8"	1/2"
4312	3/8"	9/16"
4313	7/16"	5/8"
4314	1/2"	11/16"
4315	9/16"	3/4"
4316	5/8"	13/16"
4317	11/16"	7/8"
4318	3/4"	15/16"
4319	3/4"	1"
4320	13/16"	1-1/16"
4321	7/8"	1-1/8"
4322	15/16"	1-3/16"
4323	1"	1-1/4"
4324	1-1/16"	1-5/16"

Sec. 15

“6000” SERIES SMALL DRAWER FIX-KITS

Photos not actual size

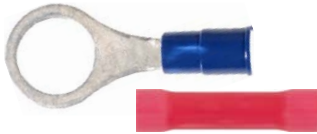

6175 Fix-Kit
Vinyl Insulated
Solderless Terminals
24 Varieties - 164 Pieces

Auveco Part No.	Gauge	Wire Size	Stud Type
5023	22-18	#8 - #10	Ring
5026	16-14	#8 - #10	Ring
5027	16-14	#12 - 1/4"	Ring
5028	12-10	#8 - #10	Ring
5029	12-10	#12 - 1/4"	Ring
5030	12-10	1/4" - 5/16"	Ring
5031	12-10	5/16" - 3/8"	Ring
5047	22-18		Butt Connector
5048	16-14		Butt Connector
5049	12-10		Butt Connector
5067	16-14		Male Quick-Connect
5068	16-14		Female Quick-Connect
8781	16-14		Female Quick-Connect
9481	18-14		Electrical Connector
10719	16-14		Female Bullet Plug
11602	16-14		Female Bullet Plug
11605	16-14		Male Quick-Connect
11606	16-14		Female Quick-Connect
12144	16-14	5/16" - 3/8"	Ring
12154	22-18		Male Quick-Connect
12155	22-18		Female Quick-Connect
12156	12-10		Male Quick-Connect
12157	12-10		Female Quick-Connect
12161	18-14		Tap Connector



6173 Fix-Kit
Insulated Solderless Terminals
24 Varieties - 128 Pieces

Auveco Part No.	Gauge	Wire Size	Stud Type
5791	22-16		Butt Connector
5792	16-14		Butt Connector
5793	12-10		Butt Connector
9052	16-14	#4 - #6	Nylon Insulated Ring
9055	16-14	#8 - #10	Nylon Insulated Ring
9056	16-14	#12 - 1/4"	Nylon Insulated Ring
9057	16-14	1/4" - 5/16"	Nylon Insulated Ring
9060	16-14	#8 - #10	Nylon Insulated Spade
9481	18-14		Electrical Connector
10719	16-14		Female Snap Plug
11602	16-14		Female Snap Plug
11605	16-14		Male Quick Slide
11606	16-14		Female Quick Slide
12145	16-14		Nylon Bullet Connector
12146	16-14		Nylon Bullet Connector
12147	18-14		Nylon Male Quick Connect
12148	16-14		Nylon Female Quick Connect
12149	22-18	#6	Nylon Insulated Ring
12150	22-18	#10	Nylon Insulated Ring
12151	12-10	#10	Nylon Insulated Ring
12152	12-10	1/4"	Nylon Insulated Ring
12153	12-10	3/8"	Nylon Insulated Ring
12161	18-14		Tap Connector
12791	22-18		Tap Connector

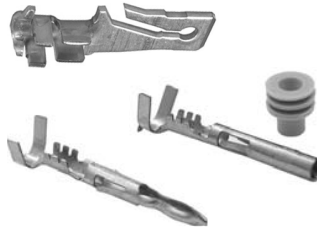

6178 Fix-Kit
O.E.M. Electrical
Terminals & Tools
GM, Ford & Chrysler
24 Varieties - 149 Pieces

Contains the following Auveco Part Numbers:
8774, 8776, 11948, 14153, 14154 14462, 14880, 14881, 14882, 14883, 14884, 14885, 14887, 14888, 14889, 14892, 15497, 15498, 15499, 15504, 15935, 16004, 20815 & 20816

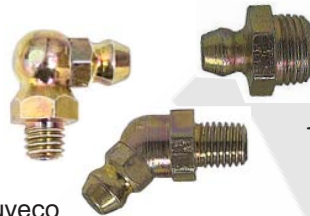

6128 Fix-Kit
Grease Fittings
12 Varieties - 145 Pieces

Auveco Part No.	Size	Type
9257	1/4" -28	Thread, Straight (Short)
9258	1/4" -28	Thread, Straight (Long)
9259	1/4" -28	Thread, Straight (Extra Long)
9260	1/4" -28	Thread, 45°
9261	1/4" -28	Thread, 90°
9262	1/8" Pipe	Thread, Straight
9264	1/8" Pipe	Thread, 45°
9265	1/8" Pipe	Thread, 65°-1/2
9266	1/8" Pipe	Thread, 90°
9267	1/8" Pipe	Thread, Straight (Extra Long)
15060	3/16"	Drive Fit, Straight
15066	1/8" Pipe	Thread, Straight (Self-Tapping)

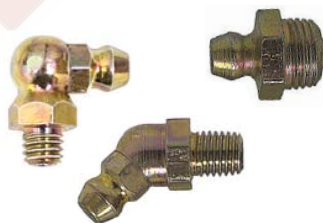

6187 Fix-Kit
Metric Grease Fittings
12 Varieties - 165 Pieces

Auveco Part No.	Size
11097	6mm-1.00, Straight
11775	6mm-1.00, 45°
11776	6mm-1.00, 90°
11098	8mm-1.00, Straight
11777	8mm-1.00, 45°
11099	8mm-1.00, 90°
11778	8mm-1.25, Straight
11779	8mm-1.25, 45°
11780	8mm-1.25, 90°
11100	10mm-1.00, Straight
15067	10mm-1.00, 45°
11101	10mm-1.00, 90°

"6000" SERIES SMALL DRAWER FIX-KITS

Photos not actual size

Sec. 15

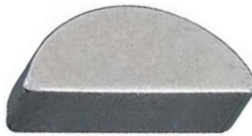

6065 Fix-Kit

Woodruff Keys
1035 Carbon Steel
20 Varieties - 383 Pieces

Auveco Part No.	Size	Key No.
3877	1/8" x 1/2"	No. 3
3878	1/8" x 5/8"	No. 5
3879	1/8" x 3/4"	No. 7
3880	3/32" x 5/8"	No. 4
3881	5/32" x 5/8"	No. 6
3882	5/32" x 3/4"	No. 8
3883	5/32" x 7/8"	No. 10
3884	3/16" x 3/4"	No. 9
3885	3/16" x 7/8"	No. 11
3886	3/16" x 1"	No. 13
3887	3/16" x 1-1/8"	No. 16
3888	7/32" x 7/8"	No. 12
3889	7/32" x 1"	No. 14
3890	7/32" x 1-1/8"	No. 17
3891	1/4" x 7/8"	No. A
3892	1/4" x 1"	No. 15
3893	1/4" x 1-1/8"	No. 18
3894	1/4" x 1-1/4"	No. 21
3895	5/16" x 1"	No. B
3896	5/16" x 1-1/8"	No. C



6125 Fix-Kit

Spring Pins
Zinc Plated
20 Varieties - 600 Pieces

Auveco Part No.	Size
9013	5/32" x 1/2"
9015	5/32" x 3/4"
9016	5/32" x 1"
9017	5/32" x 1-1/4"
9018	5/32" x 1-1/2"
9019	3/16" x 1/2"
9021	3/16" x 3/4"
9022	3/16" x 1"
9023	3/16" x 1-1/4"
9024	3/16" x 1-1/2"
9025	3/16" x 1-3/4"
9026	3/16" x 2"
9030	1/4" x 5/8"
9031	1/4" x 3/4"
9033	1/4" x 1"
9034	1/4" x 1-1/4"
9035	1/4" x 1-1/2"
9036	1/4" x 1-3/4"
9037	1/4" x 2"
9038	1/4" x 2-1/4"



6124 Fix-Kit

Spring Pins
Zinc Plated
24 Varieties - 1475 Pieces

Auveco Part No.	Size
8981	1/16" x 3/16"
8983	1/16" x 1/2"
8985	1/16" x 3/4"
8987	1/16" x 1"
8988	5/64" x 1/4"
8989	5/64" x 1/2"
8991	5/64" x 3/4"
8992	5/64" x 1"
8993	5/64" x 1-1/4"
8994	5/64" x 1-1/2"
8995	3/32" x 5/16"
8996	3/32" x 1/2"
8998	3/32" x 3/4"
9000	3/32" x 1"
9001	3/32" x 1-1/4"
9002	3/32" x 1-1/2"
9003	1/8" x 3/8"
9004	1/8" x 1/2"
9006	1/8" x 3/4"
9008	1/8" x 1"
9009	1/8" x 1-1/4"
9010	1/8" x 1-1/2"
9011	1/8" x 1-3/4"
9012	1/8" x 2"

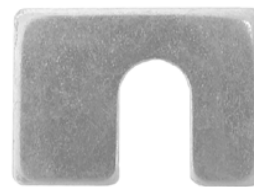

6166 Fix-Kit

Body and Fender Shims
Zinc Plated
4 Varieties - 400 Pieces

Auveco Part No.	Size	Slot
2452	1-3/4" x 1-1/4" x 1/16" Thick	1/2"
2453	1-3/4" x 1-1/4" x 1/8" Thick	1/2"
3155	1-1/4" x 1-1/8" x 1/16" Thick	3/8"
3156	1-1/4" x 1-1/8" x 1/8" Thick	3/8"



6162 Fix-Kit

"Xmas Tree" Retainers
GM-Ford-Chrysler
8 Varieties - 320 Pieces



Contains the following
Auveco Part Numbers:
**10621, 11146, 11351, 11678, 11721,
11797, 12137 & 12565**

Sec. 15

“6000” SERIES SMALL DRAWER FIX-KITS

Photos not actual size



6062 Fix-Kit
 Plug Buttons
 Nickel Plated
 9 Varieties - 270 Pieces

Auveco Part No.	Hole Size
3750	1/4"
3751	3/8"
3752	1/2"
3753	5/8"
3754	3/4"
3755	7/8"
3756	1"
10231	1-1/4"
10232	1-1/2"



6133 Fix-Kit
 Steel Tubing Clamps
 Vinyl Coated
 Galvanized
 8 Varieties - 200 Pieces

Auveco Part No.	Tube Diameter	Hole Diameter	Width
9381	1/4"	9/32"	1/2"
9382	5/16"	9/32"	1/2"
9383	3/8"	9/32"	1/2"
9384	1/2"	9/32"	1/2"
9385	5/8"	9/32"	1/2"
9386	3/4"	9/32"	1/2"
9387	7/8"	9/32"	1/2"
9388	1"	9/32"	1/2"



6176 Fix-Kit
 Thread Repair Inserts & Installation Tool
 12 Varieties - 40 Pieces

Auveco Part No.	Internal Thread Size
12374	#10-24
12375	#10-32
12376	1/4"-20
12377	1/4"-28
12378	5/16"-18
12379	5/16"-24
12380	3/8"-16
12381	3/8"-24
12382	7/16"-14
12383	7/16"-20
12384	1/2"-13
12385	1/2"-20
12404	Installation Tools



6168 Fix-Kit
 Hose Connectors
 Barbed on all sides
 8 Sizes - 155 Pieces

Auveco Part No.	Size
10101	1/8" x 1/8"
10102	3/16" x 3/16"
10103	1/4" x 1/4"
10104	5/16" x 5/16"
10105	3/8" x 3/8"
10106	1/4" x 3/16"
10107	3/8" x 1/4"
16961	1/2" x 1/2"



6167 Fix-Kit
 Tee Connectors
 Barbed on all sides
 7 Sizes - 84 Pieces

Auveco Part No.	Hose Size
10697	1/8"
10108	5/32"
10109	3/16"
10110	1/4"
14813	5/16"
11228	3/8"
11229	1/2"

STAY UP TO DATE WITH US

For the most up to date information on all Auveco items, including new items, stock availability and online ordering please visit www.auveco.com

LARGE DRAWER FIX-KIT

Photos not actual size



3-96

Empty Cabinet. Holds 2 Large Drawers.
20" Wide x 15-3/4" Deep x 8" High
Finish: Light Green Enamel
Drawer Size: 18" Wide x 12" Deep x 3" High



4-96

Cabinet & 4 Empty Large Drawers
24 Compartment Drawers with Locking Latches
20" Wide x 15-3/4" Deep x 14-1/2" High
Finish: Light Green Enamel
Drawer Size: 18" Wide x 12" Deep x 3" High

2-96

Empty Cabinet. Holds 4 Large Drawers



B-3

Base for 2-96,
3-96 & 4-96
Raises unit 15" off floor for easier bottom drawer use
Finish: Light Green Enamel

UNIT PACKAGE: 1

Empty Drawers

(18" Wide x 12" Deep x 3" High)
With Locking Latches:
1-912: 12 Compartment
1-916: 16 Compartment
1-920: 20 Compartment
1-924: 24 Compartment
1-932: 32 Compartment



Empty Plastic Tray Inserts

1-916INSERT: 16 Compartment for Drawer 1-916
1-920INSERT: 20 Compartment for Drawer 1-920
1-924INSERT: 24 Compartment for Drawer 1-924

UNIT PACKAGE: 1 case per insert
Only available in Master Case of 4 - Not sold separately.



1-900

Steel with Locking Latch

18 x 12 x 3
Adjustable
Compartment
Empty Drawer with
3 Vertical &
3 Horizontal
Dividers

UNIT PACKAGE: 1



1-901

Steel with Locking Latch

18 x 12 x 3
Adjustable
Compartment
Empty Drawer
with 9 dividers

UNIT PACKAGE: 1



1-902

Steel with Locking Latch

18 x 12 x 3
Adjustable
Compartment
Empty Drawer with
6 fixed horizontal
compartments and
12 movable
dividers adjustable
on 1" centers.

UNIT PACKAGE: 1

Sec. 15

“6500” SERIES LARGE DRAWER FIX-KITS

Photos not actual size



Auveco offers more than 46 prepackaged Fix-Kits in the 6500 series large drawer.

Each drawer measures 18" wide x 12" deep x 3" high.

Each drawer's compartment is designed to hold the entire contents of one or more standard Auveco unit packages.

Printed lid labels identify the correct Auveco part number for ordering refills.

“6500” Series Large Drawer Fix-Kit Numeric Listing

Refer to contents listing on following pages

Auveco Part No.	Description
6501	Phillips Oval Head Tapping Screws
6502	Tubular, Flat, U & J-Nuts
6503	Round Head Machine Screws & Nuts
6504	Woodruff Keys
6505	O-Rings
6506	Cotter Pins
6507	Internal & External Retaining Rings
6508	E-Rings
6509	Spring Pins
6510	Spring Pins
6511	Grease Fittings
6513	Metric Cap Screws & Nuts
6514	Metric Cap Screws & Nuts
6517	Nylon Nuts
6519	GM “Xmas Tree” Retainers
6520	Ford “Xmas Tree” Retainers
6522	“Xmas Tree” Retainers
6523	Tee Connectors & Rubber Caps
6524	Well-Nuts® & Jack Nuts®
6525	Nylon Rivets
6530	Phillips Washer Head Tapping Screws
6532	Stainless Steel Screws, Nuts & Washers
6533	Stainless Steel Tapping Screws
6534	Oil Drain Plugs
6535	Extension Springs
6536	Teks® Tapping Screws

Auveco Part No.	Description
6537	Door Hinge Pins & Bushings
6538	Cylinder Head & Manifold Studs
6539	Phillips Pan Head Machine Screws & Nuts
6540	Metric Body Bolts & Nuts
6541	Small Size U.S.S. Grade 5 Cap Screws & Nuts
6542	GM Ford & Chrysler Push-Type Retainers
6543	O.E.M. Terminals & Tools
6544	Krimp & Seal Terminals
6545	GM Moulding Clips
6546	Hyundai & Kia Clips & Fasteners
6547	Volkswagen & Audi Clips & Fasteners
6548	Honda & Acura Retainers & Retaining Clips
6549	Honda & Acura Push-Type Retainers
6550	Nissan & Infiniti Retainers & Push-Type Retainers
6551	Toyota & Lexus Retainers & Retaining Clips
6552	Toyota & Lexus Push-Type Retainers
6553	Oil Drain Plugs & Gaskets
6554	J.I.S. Hex Flange Bolts & Spin Lock Nuts
6555	Mercedes-Benz Clips & Fasteners
6556	BMW Clips & Fasteners
6557	Metal Rivets
6558	Cable Ties & Harness Straps

“6500” Series/ “6000” Series Kit Cross Reference

The 6600 Series Body Hardware Master Assortments are listed on pages 324-331

6500 Kit	6000 Kit
6501	6003
6502	6007
6503	6011
6504	6065
6505	6085
6506	6112
6507	6116
6058	6123

6500 Kit	6000 Kit
6509	6124
6510	6125
6511	6128
6513	6160
6530	6182
6534	6186
6536	6144
6543	6178

"6500" SERIES LARGE DRAWER FIX-KITS

Photos not actual size

Sec. 15



6501 Fix-Kit

Phillips Oval Head Tapping Screws
Zinc & Chrome Plated
24 Varieties - 540 Pieces

Auveco Part No.	Size	Head
3069	#4 x 3/4"	
1793	#6 x 5/8"	
1794	#6 x 3/4"	
1796	#6 x 1"	
1797	#6 x 1-1/4"	
2024	#8 x 3/8"	No.6
2358	#8 x 1/2"	
2027	#8 x 1/2"	No. 6
1421	#8 x 5/8"	No. 6
1799	#8 x 3/4"	No. 6
2359	#8 x 3/4"	
1801	#8 x 1"	No. 6
1802	#8 x 1-1/8"	No. 6
2361	#8 x 1-1/4"	
1803	#8 x 1-1/4"	No. 6
2362	#8 x 1-1/2"	
1932	#8 x 1-1/2"	No. 6
1933	#8 x 1-3/4"	No. 6
1717	#10 x 3/4"	No. 8
2728	#10 x 3/4"	
1804	#10 x 1"	No. 6
1807	#10 x 1-1/8"	
2046	#10 x 1-1/2"	No. 6
2665	#10 x 2"	No. 8



6530 Fix-Kit

Phillips Flat Top Washer Head Tapping Screws
Black E-Coat Plated
12 Varieties - 1790 Pieces

Auveco Part No	Size	Plating
12950	#6 x 1/2"	Black E-Coat
12951	#6 x 3/4"	Black E-Coat
12213	#8 x 1/2"	Black E-Coat
12214	#8 x 5/8"	Black E-Coat
12215	#8 x 3/4"	Black E-Coat
12216	#8 x 1"	Black E-Coat
12217	#8 x 1-1/4"	Black E-Coat
12218	#8 x 1-1/2"	Black E-Coat
12953	#10 x 3/4"	Black E-Coat
12954	#10 x 1"	Black E-Coat
14859	#8 x 1/2"	Zinc
14861	#8 x 3/4"	Zinc



6539 Fix-Kit

Phillips Pan Head Machine Screws & Nuts
Zinc Plated
12 Varieties of Screws
4 Varieties of Nuts
2160 Pieces

Auveco Part No.	Size
Hex Nut	
728	#8-32
729	#10-32
730	#10-24
733	1/4"-20
Screw	
15381	#8-32 x 1/2"
15382	#8-32 x 3/4"
15383	#8-32 x 1"
15387	#10-24 x 1/2"
15388	#10-24 x 3/4"
15389	#10-24 x 1"
15393	#10-32 x 1/2"
15394	#10-32 x 3/4"
15395	#10-32 x 1"
15398	1/4"-20 x 1/2"
15399	1/4"-20 x 3/4"
15400	1/4"-20 x 1"



6533 Fix-Kit

Stainless Steel Phillips Head Tapping Screws
24 Varieties - 1600 Pieces

Auveco Part No.	Size	Head
9399	#6 x 1/2"	Oval
9400	#6 x 3/4"	Oval
9401	#6 x 1"	Oval
9403	#8 x 1/2"	Oval
9404	#8 x 3/4"	Oval
9405	#8 x 1"	Oval
9406	#8 x 1-1/4"	Oval
9407	#8 x 1-1/2"	Oval
9409	#10 x 3/4"	Oval
9410	#10 x 1"	Oval
9412	#10 x 1-1/2"	Oval
13265	#6 x 1/2"	Pan
13266	#6 x 3/4"	Pan
13267	#6 x 1"	Pan
13269	#8 x 1/2"	Pan
13270	#8 x 3/4"	Pan
13271	#8 x 1"	Pan
13272	#8 x 1-1/4"	Pan
13273	#8 x 1-1/2"	Pan
13274	#10 x 1/2"	Pan
13275	#10 x 3/4"	Pan
13276	#10 x 1"	Pan
13277	#10 x 1-1/4"	Pan
13278	#10 x 1-1/2"	Pan

Sec. 15

“6500” SERIES LARGE DRAWER FIX-KITS

Photos not actual size



6503 Fix-Kit

Slotted Round Head
Machine Screws
Zinc Plated
19 Varieties of Screws
5 Varieties of Nuts
1110 Pieces

Auveco Part No.	Size
Nut	
727	#6-32
728	#8-32
729	#10-32
730	#10-24
731	#12-24
Screw	
2530	#6-32 x 1/2"
2531	#6-32 x 3/4"
2532	#6-32 x 1"
2533	#8-32 x 1/2"
2534	#8-32 x 3/4"
2535	#8-32 x 1"
2536	#10-32 x 1/2"
2537	#10-32 x 3/4"
2538	#10-32 x 1"
2539	#10-32 x 1-1/4"
2540	#10-32 x 1-1/2"
2541	#10-24 x 1/2"
2542	#10-24 x 3/4"
2543	#10-24 x 1"
2544	#10-24 x 1-1/4"
2545	#10-24 x 1-1/2"
2546	#12-24 x 1/2"
2548	#12-24 x 1"
2550	#12-24 x 1-1/2"



6536 Fix-Kit

Teks® Self-Drilling Screws
Phillips Pan Head
Hex Washer Head
Zinc Plated
16 Varieties - 365 Pieces



Auveco Part No.	Size	Head
9605	#8 x 1/2"	Pan
9606	#8 x 3/4"	Pan
9607	#10 x 1/2"	Pan
9608	#10 x 3/4"	Pan
11905	#12 x 1"	Pan
9611	#8 x 1/2"	Hex
9612	#8 x 3/4"	Hex
9613	#10 x 1/2"	Hex
9614	#10 x 5/8"	Hex
9615	#10 x 3/4"	Hex
9616	#10 x 1"	Hex
11911	#12 x 1"	Hex
9620	#14 x 3/4"	Hex
11914	#14 x 1"	Hex
11915	#14 x 1-1/4"	Hex
11916	#14 x 1-1/2"	Hex

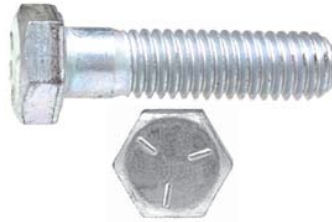

6541 Fix-Kit

U.S.S. Grade 5
Cap Screws with Nuts
Zinc Plated
12 Varieties of Screws
3 Varieties of Nuts
540 Pieces

Auveco Part No.	Size
Screw	
5434	1/4"-20 x 1/2"
5436	1/4"-20 x 3/4"
5438	1/4"-20 x 1"
5440	1/4"-20 x 1-1/2"
5449	5/16"-18 x 3/4"
5451	5/16"-18 x 1"
5453	5/16"-18 x 1-1/2"
5455	5/16"-18 x 2"
5465	3/8"-16 x 1"
5466	3/8"-16 x 1-1/4"
5467	3/8"-16 x 1-1/2"
5469	3/8"-16 x 2"
Hex Nut	
15586	1/4"-20
15587	5/16"-18
15588	3/8"-16



6514 Fix-Kit

DIN 931 & DIN 933
Metric Regular Pitch
Cap Screws & Nuts
Zinc Plated
15 Varieties - 128 Pieces

Auveco Part No.	Size
Screw	
14424	M8-1.25 x 40mm
14425	M8-1.25 x 45mm
14426	M8-1.25 x 50mm
14431	M10-1.50 x 25mm
14432	M10-1.50 x 30mm
14433	M10-1.50 x 35mm
14434	M10-1.50 x 40mm
14436	M10-1.50 x 50mm
14440	M12-1.75 x 25mm
14441	M12-1.75 x 30mm
14442	M12-1.75 x 35mm
14443	M12-1.75 x 40mm
Nut	
14452	M8-1.25
14454	M10-1.50
14455	M12-1.75

"6500" SERIES LARGE DRAWER FIX-KITS

Photos not actual size

Sec. 15



6540 Fix-Kit

Metric Body Bolts & Nuts
10 Varieties of Bolts
5 Varieties of Extruded U-Nuts
3 Varieties of Free Spinning Washer Nuts
2 Varieties of Hex Flange Nuts
254 Pieces

Auveco Part No.	Size	Type
12693	M6-1.0 x 20mm	Bolt
12324	M6-1.0 x 20mm	Bolt
12160	M6-1.0 x 22mm	Bolt
12065	M6-1.0 x 25mm	Bolt
12066	M6-1.0 x 25mm	Bolt
12335	M6-1.0 x 28mm	Bolt
17388	M8-1.25 x 20mm	Bolt
13613	M8-1.25 x 25mm	Bolt
13614	M8-1.25 x 30mm	Bolt
11641	M10-1.50 x 40mm	Bolt
11644	M8-1.25	Hex Flange Nut
11645	M10-1.5	Hex Flange Nut
12595	M6-1.0	Free Spin Washer Nut
15329	M6-1.0	Free Spin Washer Nut
15335	M8-1.25	Free Spin Washer Nut
12669	M6-1.0	Extruded U-Nut
12575	M6-1.0	Extruded U-Nut
11630	M8-1.25	Extruded U-Nut
11629	M8-1.25	Extruded U-Nut
11631	M10-1.5	Extruded U-Nut

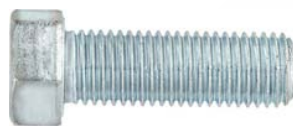

6513 Fix-Kit

DIN 933
Metric Regular Pitch
Cap Screws & Nuts
Zinc Plated
16 Varieties - 236 Pieces

Auveco Part No.	Size
Screws	
14400	M4-.7 x 16mm
14401	M4-.7 x 20mm
14402	M5-.8 x 10mm
14403	M5-.8 x 16mm
14404	M5-.8 x 20mm
14405	M5-.8 x 25mm
14408	M6-1.0 x 16mm
14409	M6-1.0 x 20mm
14410	M6-.10 x 25mm
14420	M8-1.25 x 20mm
14421	M8-1.25 x 25mm
14422	M8-1.25 x 30mm
Nut	
14448	M4-.7
14449	M5-.8
14450	M6-1.0
14452	M8-1.25



6532 Fix-Kit

Stainless Steel Cap Screws,
Nuts & Washers
24 Varieties - 660 Pieces

Auveco Part No.	Size	Type
13346	1/4"-20 x 1/2"	Screw
13347	1/4"-20 x 3/4"	Screw
13348	1/4"-20 x 1"	Screw
13349	1/4"-20 x 1-1/4"	Screw
13350	1/4"-20 x 1-1/2"	Screw
13352	1/4"-20 x 2"	Screw
13354	5/16"-18 x 3/4"	Screw
13355	5/16"-18 x 1"	Screw
13356	5/16"-18 x 1-1/4"	Screw
13357	5/16"-18 x 1-1/2"	Screw
13359	5/16"-18 x 2"	Screw
13364	3/8"-16 x 1"	Screw
13365	3/8"-16 x 1-1/4"	Screw
13366	3/8"-16 x 1-1/2"	Screw
13368	3/8-16 x 2"	Screw
13234	1/4"-20	Hex Nut
13235	5/16"-18	Hex Nut
13236	3/8"-16	Hex Nut
13395	Bolt Size: 1/4"	Flat Washer
13396	Bolt Size: 5/16"	Flat Washer
13397	Bolt Size: 3/8"	Flat Washer
13403	Bolt Size: 1/4"	Lock Washer
13404	Bolt Size: 5/16"	Lock Washer
13405	Bolt Size: 3/8"	Lock Washer



6554 Fix-Kit

J.I.S. Hex Flange Bolts
& Spin Lock Nuts
21 Varieties - 322 Pieces

Auveco Part No.	Size
Bolts	
17315	M6-1.0 x 12mm
17316	M6-1.0 x 16mm
18807	M6-1.0 x 20mm
21048	M6-1.0 x 25mm
18808	M6-1.0 x 30mm
18809	M6-1.0 x 40mm
18980	M8-1.25 x 12mm
17387	M8-1.25 x 16mm
17388	M8-1.25 x 20mm
21051	M8-1.25 x 25mm
17389	M8-1.25 x 30mm
21052	M8-1.25 x 35mm
17390	M8-1.25 x 40mm
21053	M8-1.25 x 45mm
17188	M10-1.25 x 16mm
17189	M10-1.25 x 20mm
21054	M10-1.25 x 25mm
17190	M10-1.25 x 30mm
21055	M10-1.25 x 35mm
17191	M10-1.25 x 40mm
21056	M10-1.25 x 45mm
Nut	
16769	M6-1.0
16830	M8-1.25
16470	M10-1.25

Sec. 15

“6500” SERIES LARGE DRAWER FIX-KITS

Photos not actual size

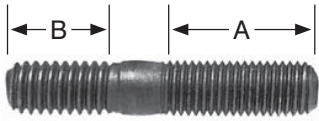

6538 Fix-Kit
Cylinder Head & Manifold Studs
24 Varieties - 120 Pieces

Auveco Part No.	Dimensions A B
9667	A: 1/4"-28 x 7/16" B: 1/4"-20 x 7/16"
9669	A: 1/4"-28 x 3/4" B: 1/4"-20 x 1/2"
9674	A: 5/16"-24 x 5/8" B: 5/16"-18 x 1/2"
9675	A: 5/16"-24 x 5/8" B: 5/16"-18 x 3/4"
9676	A: 5/16"-24 x 7/8" B: 5/16"-18 x 9/16"
9677	A: 5/16"-24 x 1" B: 5/16"-18 x 9/16"
9679	A: 5/16"-18 x 7/8" B: 5/16"-18 x 7/16"
9683	A: 3/8"-24 x 3/4" B: 3/8"-16 x 1/2"
9684	A: 3/8"-24 x 3/4" B: 3/8"-16 x 1/2"
9686	A: 3/8"-24 x 1" B: 3/8"-16 x 5/8"
9687	A: 3/8"-16 x 1-1/8" B: 3/8"-16 x 5/8"
14827	A: 3/8"-16 x 1-1/2" B: 3/8"-16 x 7/16"
9689	A: 3/8"-24 x 1" B: 3/8"-16 x 3/4"
9690	A: 3/8"-24 x 2" B: 3/8"-16 x 5/8"
9699	A: 7/16"-20 x 3/4" B: 7/16"-14 x 9/16"
9701	A: 7/16"-20 x 7/8" B: 7/16"-14 x 3/4"
9705	A: 7/16"-20 x 3/4" B: 7/16"-14 x 3/4"
9711	A: 7/16"-14 x 1-1/4" B: 7/16"-14 x 3/4"
9715	A: 7/16"-20 x 1-13/16" B: 7/16"-14 x 3/4"
9728	A: 1/2"-20 x 15/16" B: 1/2"-13 x 13/16"
9731	A: 1/2"-20 x 1" B: 1/2"-13 x 3/4"
9732	A: 1/2"-20 x 2" B: 1/2"-13 x 3/4"
11982	A: M8-1.25 x 22mm B: M8-1.25 x 10mm 40mm Overall
11983	A: M8-1.25 x 22mm B: M8-1.25 x 10mm 45mm Overall



6524 Fix-Kit
Special Purpose Well Nuts® & Jack Nuts® (O.E.M. Application) GM, Ford, Chrysler & AMC
12 Varieties - 170 Pieces



Contains the following Auveco Part Numbers:
12995, 12999, 13004, 13007, 13008, 13009, 13010, 13014, 13016, 13017, 13231 & 16253

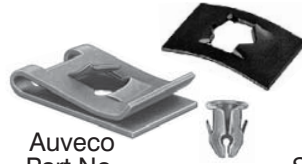

6502 Fix-Kit
Tubular, Flat, U & J-Nuts
24 Varieties - 515 Pieces

Auveco Part No.	Size	Type
1903	1/4"-20	Flat
2089	#6-32	Flat
2092	#10-24	Flat
2099	1/8" Stud	Flat
2103	3/16" Stud	Flat
2105	1/4" Stud	Flat
2293	1/4"-20	U-Nut
2346	#8	J-Nut
2422	#10	U-Nut
2595	1/8" Stud	Tubular
2611	1/8" Stud	Tubular
5170	3/8"-16	J Cage
5197	#10-24	U-Nut
5586	1/4"-20	J Cage
5589	5/16"-18	J Cage
9879	#8	Spring U
9880	#8	Spring U
10064	#6	Spring U
10065	#8	Spring U
10066	#10	Spring U
10067	#14	Spring U
10666	#8	U-Nut
11292	#8	U-Nut
11429	#10	U-Nut



6507 Fix-Kit
Basic Internal & External Retaining Rings
Zinc Plated
24 Varieties - 1000 Pieces



Auveco Part No.	Shaft Diameter
Internal Type	
8688	1/4"
8689	5/16"
8690	3/8"
8691	7/16"
8692	1/2"
8693	9/16"
8694	5/8"
8695	3/4"
8696	7/8"
8697	1"
8698	1-1/8"
8699	1-1/4"
External Type	
8701	1/4"
8702	5/16"
8703	3/8"
8704	7/16"
8705	1/2"
8706	9/16"
8707	5/8"
8708	3/4"
8709	7/8"
8710	1"
8711	1-1/8"
8712	1-1/4"

“6500” SERIES LARGE DRAWER FIX-KITS

Photos not actual size

Sec. 15



6508 Fix-Kit
E & Reinforced E-Rings
Groove Required
24 Varieties - 1500 Pieces



Auveco Part No.	Shaft Diameter	Type
8824	1/16"	E-Type
8825	3/32"	E-Type
8836	3/32"	Reinforced E
3165	1/8"	Reinforced E
8826	1/8"	E-Type
3166	3/16"	Reinforced E
8827	3/16"	E-Type
3167	1/4"	Reinforced E
8828	1/4"	E-Type
3628	5/16"	Reinforced E
3824	5/16"	E-Type
5600	3/8"	Reinforced E
8829	3/8"	E-Type
2672	7/16"	Reinforced E
8830	7/16"	E-Type
8837	1/2"	Reinforced E
5602	1/2"	E-Type
5601	9/16"	Reinforced E
5603	5/8"	E-Type
8831	3/4"	E-Type
8832	7/8"	E-Type
8833	1"	E-Type
8834	1-3/16"	E-Type
8835	1-3/8"	E-Type

6535 Fix-Kit

Extension & Compression Springs
12 Varieties - 94 Pieces



Auveco Part No.	Length
14074	1-1/4"
14072	1-7/16"
14096	2-1/2"
14070	2-21/32"
14063	3-1/4"
14064	4"
14067	4"
14066	4-1/16"
14065	4-1/2"
14068	5-1/4"
14059	6-7/16"
14060	6-1/2"

6506 Fix-Kit

Hammer-lock Cotter Pins
Bright Zinc Chromate
16 Varieties - 1500 Pieces

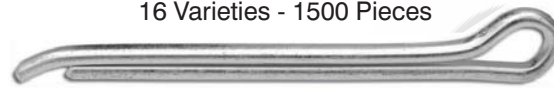

Auveco Part No.	Size
8477	1/16" x 1/2"
8478	1/16" x 3/4"
8479	1/16" x 1"
8480	1/16" x 1-1/2"
8481	3/32" x 3/4"
8482	3/32" x 1"
8484	3/32" x 1-1/2"
8485	3/32" x 2"
8486	1/8" x 1"
8487	1/8" x 1-1/4"
8488	1/8" x 1-1/2"
8490	1/8" x 2"
8491	1/8" x 2-1/2"
8492	5/32" x 1"
8493	5/32" x 1-1/2"
8494	5/32" x 2"

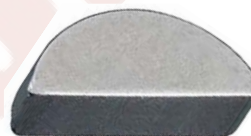

6504 Fix-Kit

Woodruff Keys
1035 Carbon Steel
20 Varieties - 383 Pieces

Auveco Part No.	Size	Key No.
3877	1/8" x 1/2"	No. 3
3878	1/8" x 5/8"	No. 5
3879	1/8" x 3/4"	No. 7
3880	3/32" x 5/8"	No. 4
3881	5/32" x 5/8"	No. 6
3882	5/32" x 3/4"	No. 8
3883	5/32" x 7/8"	No. 10
3884	3/16" x 3/4"	No. 9
3885	3/16" x 7/8"	No. 11
3886	3/16" x 1"	No. 13
3887	3/16" x 1-1/8"	No. 16
3888	7/32" x 7/8"	No. 12
3889	7/32" x 1"	No. 14
3890	7/32" x 1-1/8"	No. 17
3891	1/4" x 7/8"	No. A
3892	1/4" x 1"	No. 15
3893	1/4" x 1-1/8"	No. 18
3894	1/4" x 1-1/4"	No. 21
3895	5/16" x 1"	No. B
3896	5/16" x 1-1/8"	No. C

Sec. 15

“6500” SERIES LARGE DRAWER FIX-KITS

Photos not actual size



6510 Fix-Kit
Spring Pins
Zinc Plated
20 Varieties - 600 Pieces

Auveco Part No.	Size
9013	5/32" x 1/2"
9015	5/32" x 3/4"
9016	5/32" x 1"
9017	5/32" x 1-1/4"
9018	5/32" x 1-1/2"
9019	3/16" x 1/2"
9021	3/16" x 3/4"
9022	3/16" x 1"
9023	3/16" x 1-1/4"
9024	3/16" x 1-1/2"
9025	3/16" x 1-3/4"
9026	3/16" x 2"
9030	1/4" x 5/8"
9031	1/4" x 3/4"
9033	1/4" x 1"
9034	1/4" x 1-1/4"
9035	1/4" x 1-1/2"
9036	1/4" x 1-3/4"
9037	1/4" x 2"
9038	1/4" x 2-1/4"



6509 Fix-Kit
Spring Pins
Zinc Plated
24 Varieties - 1475 Pieces

Auveco Part No.	Size
8981	1/16" x 3/16"
8983	1/16" x 1/2"
8985	1/16" x 3/4"
8987	1/16" x 1"
8988	5/64" x 1/4"
8989	5/64" x 1/2"
8991	5/64" x 3/4"
8992	5/64" x 1"
8993	5/64" x 1-1/4"
8994	5/64" x 1-1/2"
8995	3/32" x 5/16"
8996	3/32" x 1/2"
8998	3/32" x 3/4"
9000	3/32" x 1"
9001	3/32" x 1-1/4"
9002	3/32" x 1-1/2"
9003	1/8" x 3/8"
9004	1/8" x 1/2"
9006	1/8" x 3/4"
9008	1/8" x 1"
9009	1/8" x 1-1/4"
9010	1/8" x 1-1/2"
9011	1/8" x 1-3/4"
9012	1/8" x 2"



6523 Fix-Kit
Nylon Connectors &
Rubber Caps
24 Varieties - 320 Sizes

Auveco Part No.	Size	Type
Nylon Connectors		
12929	1/8" x 1/8"	Straight
12930	1/8" x 3/16"	Straight
12936	1/8" x 1/4"	Straight
12937	3/16" x 3/16"	Straight
12935	1/4" x 3/16"	Straight
12931	1/4" x 1/4"	Straight
12946	5/16" x 5/16"	Straight
12923	1/8" x 1/8" x 1/8"	Tee
12916	1/8" x 1/8" x 3/16"	Tee
12926	3/16" x 1/8" x 3/16"	Tee
12918	3/16" x 3/16" x 3/16"	Tee
12919	1/4" x 3/16" x 3/16"	Tee
11738	1/4" x 3/16" x 1/4"	Tee
12921	3/8" x 1/4" x 3/8"	Tee
12920	5/16" x 5/16" x 5/16"	Tee
12927	3/16" x 3/16" x 3/16"	Y
12943	1/4" x 1/4" x 1/4"	Y
12932	3/16" x 3/16"	Elbow
12939	3/16"	Cross
Rubber Caps		
12209	For 1/8" O.D. Tube	
4440	For 3/16" O.D. Tube	
4439	For 1/4" O.D. Tube	
12907	For 5/16" O.D. Tube	
12210	For 3/8" O.D. Tube	

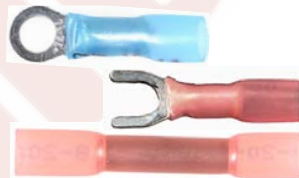

6544 Fix-Kit
Krimp & Seal Terminals
Featuring 3 - 1 Ratio
Heat Shrink Tubing
24 Varieties - 204 Pieces

Auveco Part No.	Description
13656	Ring Type, 22-18 Gauge
13657	Ring Type, 22-18 Gauge
13658	Spade Type, 22-18 Gauge
13659	Butt Conn., 22-18 Gauge
13660	Female Q.C., 22-18 Gauge
13661	Male Q.C., 22-18 Gauge
13662	Ring Type, 16-14 Gauge
13663	Ring Type, 16-14 Gauge
13664	Ring Type, 16-14 Gauge
13665	Ring Type, 16-14 Gauge
13666	Ring Type, 16-14 Gauge
13669	Butt Conn., 16-14 Gauge
13670	Female Q.C., 16-14 Gauge
13671	Male Q.C., 16-14 Gauge
13672	Female Q.C., 16-14 Gauge
13673	Male, Q.C., 16-14 Gauge
13674	Ring Type, 12-10 Gauge
13675	Ring Type, 12-10 Gauge
13676	Ring Type, 12-10 Gauge
13678	Butt Conn., 12-10 Gauge
13679	Female Q.C., 12-10 Gauge
13680	Male Q.C., 12-10 Gauge
13681	Female Plug, 16-14 Gauge
13682	Male Plug, 16-14 Gauge

"6500" SERIES LARGE DRAWER FIX-KITS

Photos not actual size

Sec. 15



6543 Fix-Kit

O.E.M. Electrical
Terminals & Tools
GM, Ford & Chrysler
24 Varieties - 263 Pieces

Contains the following Auveco Part Numbers:
**8774, 8776, 14150, 14151, 14152, 14462, 14880,
14881, 14883, 14884, 14885, 14892, 15497, 15498,
15499, 15504, 15937, 15948, 15955, 18324,
18325, 18326, 20583 & 20618**



6558 Fix-Kit

Cable Ties & Straps
10 Varieties - 339 Pieces

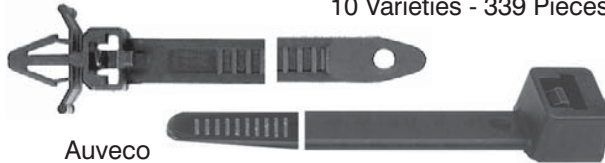

Auveco Part No.	Size
8550	2-1/4" Long, 7/16" Wide
14298	140mm Long, 8mm Wide
15144	4" Long, 3/32" Wide
15145	5-1/2" Long, 1/8" Wide
15146	7" Long, 3/16" Wide
15147	11" Long, 3/16" Wide
15148	14" Long, 5/16" Wide
15753	14" Long, 3/16" Wide
20380	200mm Long, 5mm Wide
21203	155mm Long, 5mm Wide



6534 Fix-Kit

Oil Drain Plugs & Gaskets
12 Varieties - 86 Pieces

Auveco Part No.	Size
14196	1/2"-20
18373	1/2"-20
18121	1/2"-20 Double Oversize
15527	M12-1.25
14677	M12-1.75
18374	M12-1.75
21047	M12-1.75
14678	M14-1.5
16308	M14-1.5
19279	M14-1.5
19773	M14-1.5
15529	M18-1.5



6553 Fix-Kit

Oil Drain Plugs &
Gaskets
24 Varieties
55 Pieces

Auveco Part No.	Size
14196	1/2"-20
18373	1/2"-20
19130	1/2"-20
19365	1/2"-20, Magnetic
15527	M12-1.25
19588	M12-1.25
14677	M12-1.75
18023	M12-1.75
18374	M12-1.75
20347	M12-1.75
21047	M12-1.75
18024	M14-1.25
14678	M14-1.5
16308	M14-1.5
18025	M14-1.5
18375	M14-1.5
19141	M14-1.5
19279	M14-1.5
19620	M14-1.5 Single Oversize
19773	M14-1.5
20426	M14-1.5
15528	M16.4-1.33
15529	M18-1.5
15530	M20-1.5



6511 Fix-Kit

Grease Fittings
12 Varieties - 145 Pieces



Auveco Part No.	Type
9257	1/4" - 28 Thread, Straight (Short)
9258	1/4" - 28 Thread, Straight (Long)
9259	1/4" - 28 Thread, Straight (Extra Long)
9260	1/4" - 28 Thread - 45°
9261	1/4" - 28 Thread - 90°
9262	1/8" Pipe Thread - Straight
9264	1/8" Pipe Thread - 45°
9265	1/8" Pipe Thread - 65°
9266	1/8" Pipe Thread - 90°
9267	1/8" Pipe Thread, Straight (Extra Long)
15060	3/16" Drive Fit, Straight
15066	1/8" Pipe, Straight (Self-Tapping)

Sec. 15

“6500” SERIES LARGE DRAWER FIX-KITS

Photos not actual size



6525 Fix-Kit

Black Nylon Blind Rivets
16 Varieties - 400 Pieces

Auveco Part No.	Diameter	Grip
13746	3/16"	1/16"-9/64"
13747	13/64"	1/16"-11/64"
14005	13/64"	1/8"-5/32"
13748	13/64"	1/8"-15/64"
13755	13/64"	15/64"-25/64"
14004	15/64"	11/64"-11/32"
14023	15/64"	5/32"-5/16"
18502	1/4"	5/32"-1/4"
18108	1/4"	5/32"-3/8"
13751	1/4"	5/32"-13/32"
13750	1/4"	5/32"-13/32"
15491	1/4"	19/64"-27/64"
17101	1/4"	5/16"-15/32"
13752	17/64"	3/32"-3/16"
13753	17/64"	3/32"-3/16"
15490	9/32"	3/32"-15/64"



6557 Fix-Kit

Metal Specialty Rivets
24 Varieties - 624 Pieces

Auveco Part No.	Grip
20788	3/64" - 1/8"
20627	3/64" - 3/16"
16834	1/8" - 3/16"
8931	3/16" - 1/4"
17615	3/16" - 3/8"

1/8" (3.2mm) Diameter

20788	3/64" - 1/8"
20627	3/64" - 3/16"
16834	1/8" - 3/16"
8931	3/16" - 1/4"
17615	3/16" - 3/8"

5/32" (4mm) Diameter

18461	3/64" - 1/4"
20629	3/64" - 1/4"
20971	3/64" - 9/32"
19376	1/8" - 11/32"
17006	1/4" - 3/8"

3/16" (4.8mm) Diameter

16864	3/64" - 11/32"
20741	3/64" - 23/64"
17121	5/64" - 15/64"
8311	1/8" - 1/4"
17410	3/8" - 1/2"
14127	3/8" - 1/2"

1/4" (6.4mm) Diameter

16837	1/32" - 9/64"
12653	3/32" - 1/8"
18167	3/32" - 9/64"
12652	1/8" - 1/4"
12655	9/64" - 3/16"
17639	3/16" - 3/8"
8313	1/4" - 3/8"
16838	33/64" - 19/32"



6505 Fix-Kit

Rubber O-Rings
20 Varieties - 300 Pieces

Auveco Part No.	Inner Diameter	Outer Diameter
4305	1/8"	1/4"
4306	5/32"	9/32"
4307	3/16"	5/16"
4308	7/32"	11/32"
4309	1/4"	3/8"
4310	5/16"	7/16"
4311	3/8"	1/2"
4312	3/8"	9/16"
4313	7/16"	5/8"
4314	1/2"	11/16"
4315	9/16"	3/4"
4316	5/8"	13/16"
4317	11/16"	7/8"
4318	3/4"	15/16"
4319	3/4"	1"
4320	13/16"	1-1/16"
4321	7/8"	1-1/8"
4322	15/16"	1-3/16"
4323	1"	1-1/4"
4324	1-1/16"	1-5/16"

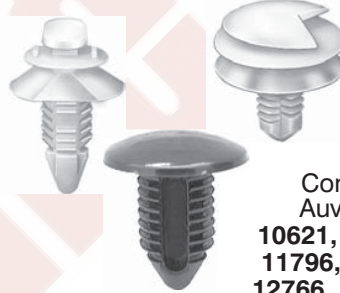

6519 Fix-Kit

"Xmas Tree" Retainers
GM
12 Varieties - 500 Pieces

Contains the following
Auveco Part Numbers:
**10621, 10831, 11146, 11678,
11796, 12137, 12731, 12737,
12766, 15970, 16818 & 17664**



6522 Fix-Kit

"Xmas Tree" Retainers
GM, Ford & Chrysler
12 Varieties - 550 Pieces

Contains the following
Auveco Part Numbers:
**10831, 11146, 11796, 12137,
12565, 12737, 12766, 12909,
16818, 17339, 17612 & 17664**



6520 Fix-Kit

"Xmas Tree" Retainers
Ford
12 Varieties - 465 Pieces

Contains the following
Auveco Part Numbers:
**10831, 11136, 11146, 11351,
11671, 12565, 12571, 12909,
14757, 17339, 17664 & 20192**

"6500" SERIES LARGE DRAWER FIX-KITS

Photos not actual size

Sec. 15



6517 Fix-Kit

Nylon Nuts
16 Varieties - 850 Pieces

Contains the following Auveco Part Numbers:
2625, 3682, 5228, 8435, 9829, 9851, 9862,
10330, 11368, 11691, 11719, 11838, 11855,
13450, 13933 & 18816



6545 Fix-Kit

GM Moulding Clips
24 Varieties
234 Pieces

Contains the following Auveco Part Numbers:
10617, 14642, 19757, 19800, 19820, 19821, 19822,
20280, 20318, 20328, 20353, 20377, 20607, 20756,
20774, 20808, 20865, 20884, 20934, 20952,
20972, 20976, 21128 & 21374



6556 Fix-Kit

BMW Clips & Fasteners
14 Varieties
416 Pieces

Auveco Part No.

Description

13158	Moulding Clip
13162	U-Nut
13215	U-Nut
13216	U-Nut
13218	U-Nut
13223	U-Nut
18156	M4.8-1.59 x 16mm L.P. Screw
20186	Grommet
20234	Push-Type Retainer
20248	Push-Type Retainer
20253	Trim Panel Retainer
20270	Push-Type Retainer
20734	Push-Type Retainer
20754	Nylon Rivet



6542 Fix-Kit

GM, Ford & Chrysler Push-Type Retainers
11 Varieties - 325 Pieces

Contains the following Auveco Part Numbers:
20826, 20880, 20888, 20889, 20988, 20989,
20990, 20991, 20992, 20993 & 20994



6548 Fix-Kit

Honda & Acura Retainers & Retaining Clips
24 Varieties - 404 Pieces

Contains the following Auveco part numbers:
14289, 14291, 14328, 15998, 16775, 16776, 16779,
17205, 18114, 18294, 18746, 18877, 19114, 19116,
19145, 19171, 19470, 19506, 19682, 20334,
20609, 20610, 20882 & 21107



6549 Fix-Kit

Honda & Acura Push-Type Retainers
24 Varieties - 254 Pieces

Contains the following Auveco part numbers:
14696, 14697, 16000, 16782, 17057,
17143, 17144, 17267, 17379, 18119, 19118,
19140, 19231, 19233, 19239, 19416, 19453, 20247,
20352, 20564, 20608, 20986, 21173 & 21297

6537 Fix-Kit

Door Hinge Pins & Bushings
15 Varieties - 221 Pieces



Bushings
14548, 14549, 14550, 14551,
14552, 14553, 16936, 16937, 17167 & 17434



Pins
14559, 19183, 19424 & 19781



6546 Fix-Kit

Hyundai & Kia Clips & Fasteners
20 Varieties
375 Pieces

Auveco Part No.

Description

20543	Hood Insulation Retainer
20566	Moulding Clip
20567	Moulding Clip
20568	Moulding Clip
20680	M6-1.0 L.P. Screw
21064	Moulding Clip
21067	Bumper & Grille Retainer
21068	Nylon Nut
21070	Trim Panel Retainer
21136	Moulding Clip
21146	Push-Type Retainer
21188	Trim Panel Retainer
21244	Moulding Clip
21312	Moulding Clip
21321	Moulding Clip
21328	Push-Type Retainer
21360	Trim Panel Retainer
21378	Nylon U-Nut
21381	Hood Seal Retainer
21382	Cowl Vent & Grille Retainer

Sec. 15

“6500” SERIES LARGE DRAWER FIX-KITS

Photos not actual size



6555 Fix-Kit

Mercedes-Benz
Clips & Fasteners
24 Varieties - 488 Pieces

Auveco Part No.	Description
13215	U-Nut
13216	U-Nut
13218	U-Nut
13220	U-Nut
13223	U-Nut
13224	U-Nut
13230	Push-Type Retainer
16124	Tubular Type Nut
20187	Push-Type Retainer
20188	Trim Panel Retainer
20203	Push-Type Retainer
20205	Moulding Insert
20314	Push-Type Retainer
20636	Push-Type Retainer
20637	Push-Type Retainer
20638	Push-Type Retainer
20642	Door Panel Retainer Clip
20645	Carpet Retainer
20650	U-Nut
20735	Door Panel Retainer
20897	Moulding Clip
20909	Push-Type Retainer
20971	Rivet
21105	Hood Insulation Retainer



6550 Fix-Kit

Nissan & Infiniti
Retainers &
Push-Type Retainers
24 Varieties - 369 Pieces

Contains the following
Auveco part numbers:

14355, 14696, 14737, 16000, 16776, 16782, 16784,
16858, 16859, 17237, 17347, 17452, 17472, 18166,
18948, 19246, 19274, 19684, 20327, 20348,
20349, 20672, 20953 & 21192



6551 Fix-Kit

Toyota & Lexus
Retainers
& Retaining Clips
24 Varieties - 361 Pieces

Contains the following
Auveco part numbers:

14269, 14736, 14737, 14738, 15709, 18297, 18692,
18842, 18844, 18876, 18878, 19112, 19113, 19210,
19257, 19729, 19749, 19842, 20437, 20443,
20633, 20757, 20758 & 21102



6552 Fix-Kit

Toyota & Lexus
Push-Type Retainers
24 Varieties - 229 Pieces

Contains the following
Auveco part numbers:

14260, 16784, 17162, 17439,
18270, 18873, 18888, 19140, 19416, 19552,
19739, 20335, 20349, 20577, 20869, 20908, 20931,
20955, 21010, 21011, 21103, 21123, 21201 & 21294



6547 Fix-Kit

Volkswagen & Audi
Clips &
Fasteners
24 Varieties
385 Pieces

Auveco
Part No.

Description

13173	Door Panel Clip
13475	Trim Panel Retainer
17006	Moulding Rivet
19195	Push-Type Retainer
20341	Trim Panel Retainer
20924	Screw Grommet
20925	Screw Grommet
21144	Trim Panel Retainer
21145	Hood Insulation Retainer
21251	Push-Type Retainer
21392	Cowl Vent & Grille Retainer
21393	Trim Retainer
21394	Moulding Clip
21395	Moulding Clip
21396	Moulding Clip
21397	Moulding Clip Grommet
21398	Trim Panel Retainer
21399	Screw Grommet
21449	Moulding Clip
21478	Moulding Clip
21479	Push-Type Retainer
21512	Moulding Clip
21513	Push-On Retainer
21515	Fender & Bumper Retainer

"6900" SERIES QUIK-SELECT II ASSORTMENTS

Sec. 15

Photos not actual size



A Great Marketing Concept for New or Existing Accounts

Looking to provide more variety of coverage and be sure that there is enough product to finish the job, Quik-Select II is your answer.

Auveco's Quik-Select II features a polypropylene box that's larger than our 6800 series Quik-Select assortments. It also has a larger variety of parts in each assortment and a greater number of each part per compartment.

The assortments come in 12, 18 and 24 compartment, translucent, durable polypropylene boxes. Box lid labels have O.E.M. numbers, sizes, product pictures, code 128 barcodes and Auveco part numbers for ordering refills.

"6900" Series Quik-Select II Numeric Listing

Refer to contents listing on following pages

Auveco Part No.	Description
6901	GM Retainers
6902	Ford Retainers
6903	Chrysler Retainers
6904	GM Push-Type Retainers
6905	Ford Push-Type Retainers
6906	Chrysler Push-Type Retainers
6907	GM Nylon Nuts
6908	Ford Nylon Nuts
6910	Toyota & Lexus Retainers & Retaining Clips
6911	Honda & Acura Retainers & Retaining Clips
6912	Nissan & Infiniti Retainers & Retaining Clips
6913	Toyota & Lexus Push-Type Retainers
6914	Honda & Acura Push-Type Retainers
6915	Nissan & Infiniti Push-Type Retainers
6916	Toyota & Lexus Nylon Nuts & Screw Grommets
6917	Honda & Acura Nylon Nuts & Screw Grommets
6918	Nissan & Infiniti Nylon Nuts & Screw Grommets

Auveco Part No.	Description
6919	GM, Ford & Chrysler Push-Type Retainers
6920	Black Tapping Screws
6921	Teks® Screws
6923	Extruded U-Nuts
6924	Washer Lock Nuts, Thread Cutting Nuts, Push-On & Pushnut Retainers
6929	Rubber & Vinyl Vacuum Caps
6930	Nylon Connectors
6931	Oil Drain Plug Gaskets
6933	Rubber Grommets
6934	Door Lock Rod Clips
6935	BMW Clips & Fasteners
6936	Mercedes-Benz Clips & Fasteners
6937	Hyundai & Kia Clips & Fasteners
6938	Weatherstrip & Trim Panel Retainers
6939	Rocker Panel & Moulding Clips
6940	Asian Bumper Retainers
6941	Import Fender Retainers
6942	Ford F-150 Clips & Fasteners

Empty Compartment Boxes

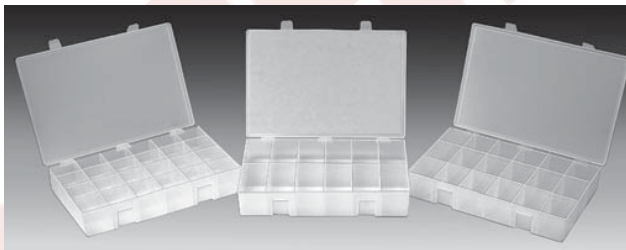

Translucent Durable Polypropylene Boxes with Locking Tabs
13-1/16" Wide x 8-13/16" Deep x 2-1/4" High

12 Compartment Box

69-12: UNIT PACKAGE: 1
69-112: UNIT PACKAGE: 10

18 Compartment Box

69-18: UNIT PACKAGE: 1
69-118: UNIT PACKAGE: 10

24 Compartment Box

69-24: UNIT PACKAGE: 1
69-124: UNIT PACKAGE: 10

Quik-Select II Rack



69-RACK

Empty Cabinet: Holds 5 Quik-Select II Assortments.
13-1/2" Wide x 9-1/8" Deep x 13-1/4" High
Finish: Gray Enamel
Keyhole slots are furnished for wall mounting.
A handle is provided and bolt holes permits stacking.

UNIT PACKAGE: 1

Sec. 15

“6900” SERIES QUIK-SELECT II ASSORTMENTS

Photos not actual size



6920
Black Tapping Screws
24 Varieties - 490 Pieces

Auveco Part No.	Size
Black Oxide Phillips Oval Head	
12897	#4 x 1"
12796	#6 x 3/4"
10162	#8 x 1/2" with #6 HD
10164	#8 x 3/4" with #6 HD
10165	#8 x 3/4"
10166	#8 x 1" with #6 HD
10167	#8 x 1"
Black Oxide Phillips Pan Head	
11917	#6 x 1/2"
10180	#8 x 1/2"
10181	#8 x 3/4"
10182	#8 x 1"
12799	#8 x 1-1/2"
11921	#10 x 1/2"
11922	#10 x 3/4"
11923	#10 x 1"
Black E-Coat Phillips Flat Washer Head	
12213	#8 x 1/2"
12214	#8 x 5/8"
12215	#8 x 3/4"
12216	#8 x 1"
12217	#8 x 1-1/4"
12218	#8 x 1-1/2"
12953	#10 x 3/4"
12954	#10 x 1"
Black Phosphate Phillips Pan Head Sems®	
12820	#8 x 3/4"



6923
Extruded U-Nuts
18 Varieties - 125 Pieces

Auveco Part No.	Size	Center of Hole to Edge
10048	#8-32	3/8"
15677	#10-24	15/32"
8359	1/4"-20	17/32"
10051	1/4"-20	25/32"
10053	5/16"-18	9/16"
8814	5/16"-18	27/32"
10054	3/8"-16	3/4"
10055	3/8"-16	1-1/8"
11625	M4-7	13.5mm
11626	M5-8	15.8mm
16846	M6-1.0	12mm
16842	M6-1.0	13.5mm
12669	M6-1.0	13.5mm
12575	M6-1.0	19.5mm
11628	M6.3-1.0	13.5mm
11629	M8-1.25	14.5mm
11630	M8-1.25	20mm
11631	M10-1.5	19mm



6921
Teks® Screws
18 Varieties - 520 Pieces



Auveco Part No.	Size
Phillips Pan Head	
9605	#8 x 1/2"
9606	#8 x 3/4"
9608	#10 x 3/4"
Hex Washer Head	
9611	#8 x 1/2"
9612	#8 x 3/4"
9613	#10 x 1/2"
9615	#10 x 3/4"
9616	#10 x 1"
11911	#12 x 1"
11914	#14 x 1"
Specialty Screws	
12095	#8 x 1/2"
15172	#8 x 1/2"
15774	#8 x 1/2"
17460	#8 x 3/4"
17650	#8 x 3/4"
18261	M4.2-1.41 x 16mm
15775	M4.2-1.41 x 20mm
19006	M4.2-1.41 x 25mm



6929
Vacuum Caps
12 Varieties - 332 Pieces



Auveco Part No.	Size
Rubber Vacuum Caps	
12209	Fits 1/8" O.D. Tube
4440	Fits 3/16" O.D. Tube
4439	Fits 1/4" O.D. Tube
19001	Fits 1/4" O.D. Tube
12907	Fits 5/16" O.D. Tube
19002	Fits 5/16" O.D. Tube
12210	Fits 3/8" O.D. Tube
12908	Fits 1/2" O.D. Tube
Vinyl Vacuum Caps	
18202	Fits 3/16" O.D. Tube
18203	Fits 1/4" O.D. Tube
18204	Fits 5/16" O.D. Tube
18205	Fits 3/8" O.D. Tube

"6900" SERIES QUIK-SELECT II ASSORTMENTS

Photos not actual size

Sec. 15



6924
Washer Lock Nuts,
Thread Cutting Nuts,
Push-On Retainers &
Pushnut Bolt Retainers
24 Varieties - 489 Pieces

Auveco Part No.	Size
Thread Cutting Nuts	
12253	5mm Stud Size
3403	1/8" Stud Size
3404	3/16" Stud Size
2896	3/16" Stud Size
2897	1/4" Stud Size
3405	1/4" Stud Size
10733	5/16" Stud Size
Washer Lock Nuts	
2557	#10-24 1/2 O.D.
2558	#10-24 3/4 O.D.
Push-On Retainers	
8863	1/8" Stud Size
8864	5/32" Stud Size
8865	3/16" Stud Size
8868	1/4" Stud Size
8869	5/16" Stud Size
10374	3/8" Stud Size
Pushnut Bolt Retainers	
10086	1/4" Bolt Size
10087	5/16" Bolt Size
9297	3/8" Bolt Size
9299	1/2" Bolt Size
12122	M5-.8 Bolt Size
12123	M6-1.0 Bolt Size
12125	M8-1.25 Bolt Size
12127	M12-1.75 Bolt Size
14980	M14-2.0 Bolt Size



6931
Oil Drain Plug Gaskets
18 Varieties
153 Pieces



Auveco Part No.	Size	Type
8277	1/2"	Nylon
15918	1/2"	Copper
15919	9/16"	Copper
16026	1/2"	Steel & Rubber
16682	14mm	Black Fibre
16955	18mm	Aluminum
16956	14mm	Aluminum
16996	1/2"	Nylon
17261	12mm	Copper
17262	14mm	Copper
17264	18mm	Copper
17265	20mm	Copper
18299	14mm	Steel & Rubber
18665	11mm	Rubber
18726	12mm	Black Fibre
19601	12mm	Aluminum
19630	11mm	Rubber
20453	13mm	Rubber

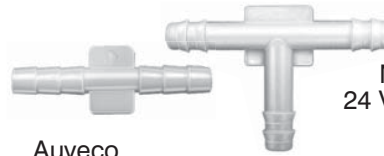

6930
Nylon Connectors
24 Varieties - 215 Pieces

Auveco Part No.	Size	Type
10101	1/8" x 1/8"	Straight
12929	1/8" x 1/8"	Straight
12930	1/8" x 3/16"	Straight
12936	1/8" x 1/4"	Straight
10102	3/16" x 3/16"	Straight
12937	3/16" x 3/16"	Straight
10103	1/4" x 1/4"	Straight
12935	3/16" x 1/4"	Straight
12931	1/4" x 1/4"	Straight
10104	5/16" x 5/16"	Straight
12946	5/16" x 5/16"	Straight
10105	3/8" x 3/8"	Straight
12923	1/8" x 1/8" x 1/8"	Tee
10108	5/32" x 5/32" x 5/32"	Tee
12926	3/16" x 1/8" x 3/16"	Tee
10109	3/16" x 3/16" x 3/16"	Tee
12918	3/16" x 3/16" x 3/16"	Tee
12919	1/4" x 3/16" x 3/16"	Tee
10110	1/4" x 1/4" x 1/4"	Tee
12921	3/8" x 1/4" x 3/8"	Tee
12920	5/16" x 5/16" x 5/16"	Tee
11228	3/8" x 3/8" x 3/8"	Tee
12927	3/16" x 3/16" x 3/16"	Y
12932	3/16" x 3/16"	Elbow



6933
Rubber Grommets
24 Varieties - 252 Pieces

Auveco Part No.	Bore Diameter	Width
4408	1/8"	3/32"
4410	5/32"	1/16"
4413	3/16"	1/16"
4414	3/16"	3/32"
4415	3/16"	1/4"
16454	1/4"	1/16"
4417	1/4"	1/16"
4419	5/16"	1/16"
4420	5/16"	1/16"
4421	5/16"	1/8"
4422	5/16"	1/4"
4423	3/8"	1/16"
16456	3/8"	1/16"
4425	3/8"	1/16"
4426	3/8"	1/4"
4428	1/2"	3/32"
4429	1/2"	3/32"
16458	1/2"	1/8"
4430	1/2"	1/4"
4431	5/8"	1/8"
4432	5/8"	1/16"
4433	3/4"	1/16"
4434	3/4"	1/16"
4436	3/4"	1/4"

Sec. 15

"6900" SERIES QUIK-SELECT II ASSORTMENTS

Photos not actual size



6901

GM Retainers
18 Varieties - 373 Pieces

Contains the following
Auveco part numbers:

10831, 11130, 11146, 11612, 11796, 12137,
12731, 12737, 12759, 12766, 12992, 14036, 15456,
15543, 15970, 16818, 17664 & 17975



6919

GM, Ford & Chrysler
Push-Type Retainers
11 Varieties - 215 Pieces

Contains the following
Auveco part numbers:

20826, 20880, 20888, 20889,
20988, 20989, 20990, 20991,
20992, 20993 & 20994



6904

GM Push-Type Retainers
18 Varieties - 233 Pieces

Contains the following
Auveco part numbers:

12567, 12757, 13993, 13994, 13996,
14010, 14011, 14020, 14753, 14997, 15044,
16622, 16835, 17216, 17222, 18353, 19639 & 19801



6942

Ford F-150 (Aluminum Body)
Clips & Fasteners
17 Varieties - 167 Pieces



Contains the following
Auveco part numbers:

11146, 17664, 19338, 19801, 20530, 20766,
20880, 20889, 21169, 21286, 21703, 22023,
22058, 22066, 22067, 22154 & 22180



6902

Ford Retainers
18 Varieties - 350 Pieces

Contains the following
Auveco part numbers:

10831, 11136, 11146, 11351,
11612, 11671, 12565, 12571,
12909, 13470, 14021, 14163, 15479,
17339, 17612, 17664, 19655 & 20192



6934

Door Lock Rod Clips
18 Varieties - 152 Pieces



Contains the following Auveco part numbers:

10262, 14359, 14365, 14967, 15518, 15673, 15674,
15675, 15759, 17122, 18392, 18393, 18926, 19658,
20469, 20470, 20534 & 20535



6903

Chrysler Retainers
18 Varieties - 338 Pieces

Contains the following
Auveco part numbers:

10831, 11129, 11136, 11146, 11351, 11678,
14921, 15481, 15543, 16818, 17004, 17612,
17664, 17975, 18033, 18862, 18915 & 19386



6905

Ford Push-Type Retainers
12 Varieties - 219 Pieces

Contains the following
Auveco part numbers:

13994, 14018, 14019, 14020,
14753, 14953, 14991, 14992,
14994, 17103, 17216 & 18894



6914

Honda & Acura
Push-Type Retainers
18 Varieties - 163 Pieces

Contains the following
Auveco part numbers:

14696, 14697, 14698, 16000, 16782,
17057, 17143, 17144, 17267, 17379, 18119,
19118, 19140, 19233, 19239, 19453, 20247 & 20564



6906

Chrysler Push-Type Retainers
12 Varieties - 205 Pieces

Contains the following
Auveco part numbers:

11699, 11704, 12567, 13993,
14016, 14019, 14992, 16835,
17216, 18030, 18269 & 19422



6907

GM Nylon Nuts
12 Varieties - 480 Pieces



Contains the following Auveco part numbers:
3682, 8435, 9829, 11424, 11691, 11719, 11838,
12735, 13450, 13933, 13960 & 14031

"6900" SERIES QUIK-SELECT II ASSORTMENTS

Photos not actual size

Sec. 15



6935

BMW Clips & Fasteners
12 Varieties
212 Pieces

Auveco Part No.	Description
13158	Moulding Clip
13162	U-Nut
13215	U-Nut
13218	U-Nut
13223	U-Nut
18156	License Plate Screw M4.8 X 16mm
20234	Nylon Rivet
20248	Push -Type Retainer
20253	Trim Panel Retainer
20270	Push -Type Retainer
20734	Push -Type Retainer
20754	Nylon Rivet



6917

Honda & Acura
Nylon Nuts & Screw Grommets
12 Varieties - 224 Pieces

Contains the following Auveco part numbers:
14255, 14268, 14274, 14281, 14288, 14313, 14695,
17058, 18415, 19454, 19734 & 19741

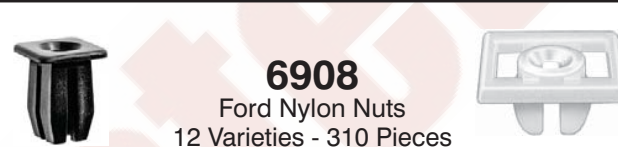

6908

Ford Nylon Nuts
12 Varieties - 310 Pieces

Contains the following Auveco part numbers:
9862, 11368, 11841, 12569, 14754, 14755, 14756,
18816, 19277, 19326, 19783 & 20245



6911

Honda & Acura
Retainers & Retaining Clips
24 Varieties - 334 Pieces

Contains the following Auveco part numbers:
14282, 14289, 14291, 14328, 15998, 16775, 16776,
16779, 17205, 18114, 18294, 18746, 18818, 18877,
19114, 19116, 19145, 19171, 19470, 19483,
19506, 19682, 20334 & 20609



6937

Hyundai & Kia
Clips & Fasteners
18 Varieties
114 Pieces

Auveco Part No.	Description
20543	Hood Insulation Retainer
20566	Moulding Clip
20567	Moulding Clip
20568	Moulding Clip
20680	M6-1.0 L. P. Screw
21064	Moulding Clip
21067	Bumper & Grille Retainer
21068	Nylon Nut
21070	Trim Panel Retainer
21136	Moulding Clip
21146	Push-Type Retainer
21188	Trim Panel Retainer
21244	Moulding Clip
21312	Moulding Clip
21321	Moulding Clip
21328	Push-Type Retainer
21378	Nylon U-Nut
21382	Cowl Vent & Grille Retainer



6936

Mercedes-Benz
Clips & Fasteners
24 Varieties
106 Pieces

Auveco Part No.	Description
13215	U-Nut
13216	U-Nut
13218	U-Nut
13220	U-Nut
13223	U-Nut
13224	U-Nut
13230	Push-Type Retainer
16124	Tubular Type Nut
20187	Push-Type Retainer
20188	Trim Panel Retainer
20203	Push-Type Retainer
20205	Moulding Insert
20314	Push-Type Retainer
20636	Push-Type Retainer
20637	Push-Type Retainer
20638	Push-Type Retainer
20642	Door Panel Retainer Clip
20645	Carpet Retainer
20650	U-Nut
20735	Door Panel Retainer
20897	Moulding Clip
20909	Push-Type Retainer
20971	Rivet
21105	Hood Insulation Retainer

Sec. 15

"6900" SERIES QUIK-SELECT II ASSORTMENTS

Photos not actual size



6910

Toyota & Lexus
Retainers & Retaining Clips
24 Varieties - 280 Pieces

Contains the following Auveco part numbers:
14144, 14269, 14270, 14736, 14737, 14738, 15707,
15709, 16779, 18297, 18692, 18842, 18844, 18876,
18878, 19112, 19113, 19124, 19210, 19257,
19729, 19749, 19842 & 20443



6912

Nissan & Infiniti
Retainers & Retaining Clips
12 Varieties - 335 Pieces

Contains the following Auveco part numbers:
14349, 14352, 14353, 14355, 14356, 14723,
14737, 16775, 16776, 17237, 17452 & 18166



6913

Toyota & Lexus
Push-Type Retainers
18 Varieties - 149 Pieces

Contains the following Auveco part numbers:
14260, 16784, 17162, 17206, 17439, 17988, 17992,
18270, 18873, 18888, 18939, 19013, 19128,
19140, 19219, 19416, 19739 & 20335



6915

Nissan & Infiniti
Push-Type Retainers
18 Varieties - 179 Pieces

Contains the following Auveco part numbers:
14696, 14727, 16000, 16725, 16782, 16783, 16784,
16843, 16858, 16859, 17347, 17472, 18265,
19246, 19274, 20327, 20348 & 20349



6918

Nissan & Infiniti
Nylon Nuts & Screw Grommets
12 Varieties - 235 Pieces

Contains the following Auveco part numbers:
13930, 13931, 14274, 14275, 14313, 14331, 14335,
14695, 14724, 17196, 17342 & 19293



6916

Toyota & Lexus
Nylon Nuts & Screw Grommets
18 Varieties - 230 Pieces

Contains the following Auveco part numbers:
13932, 14256, 14258, 14265, 14267, 14268, 14271,
14273, 14274, 14275, 14277, 14281, 14695,
19194, 19721, 19756, 19783 & 20440



6938

Weatherstrip &
Trim Panel Retainers
23 Varieties - 315 Pieces

Contains the following Auveco part numbers:
11796, 12565, 12992, 14269, 14328, 14921, 17669,
18033, 18353, 18848, 18877, 19171, 19386, 19850,
20563, 21102, 21334, 21705, 21707, 21795,
21822, 22027 & 22107



6939

Rocker Panel &
Moulding Clips
23 Varieties
171 Pieces

Contains the following Auveco part numbers:
15695, 17612, 19820, 19821, 19822, 20318, 20353,
20568, 20607, 20756, 20757, 20774, 20865, 20926,
21158, 21226, 21241, 21244, 21285, 21683,
21793, 22015 & 22068



6940

Asian Bumper Retainers
24 Varieties - 179 Pieces

Contains the following Auveco part numbers:
17206, 18119, 18873, 19233,
19246, 19470, 20184, 20349, 20564, 20608, 20878,
20931, 20953, 20986, 21173, 21682, 21706, 21836,
21856, 22042, 22077, 22096, 22125 & 22160



6941

Import Fender Retainers
24 Varieties - 199 Pieces

Contains the following Auveco part numbers:
16000, 17379, 17385, 19118, 19239, 19721, 20390,
20391, 20429, 20688, 20757, 20764, 20869, 20954,
21017, 21111, 21685, 21687, 21706, 21780,
22014, 22017, 22054 & 22141

"6800" SERIES QUIK-SELECT ASSORTMENTS

Sec. 15



Photos not actual size

Fast moving body hardware and specialty fasteners in convenient, translucent, durable polypropylene boxes.

Our Quik-Select Assortments offer popular coverage in an economical package that makes choosing the correct part fast and easy.

Assortments come in 6, 12 and 18 compartment layouts complete with O.E.M. numbers, sizes, specifications and the proper Auveco part number for ordering refills.

"6800" Series Quik-Select Numeric Listing

Refer to contents listing on following pages

Auveco Part No.	Description	Auveco Part No.	Description	Auveco Part No.	Description
6801	GM "Xmas Tree" Retainers	6826	Rubber Vacuum Caps	6852	Stainless Steel Tapping Screws
6802	Ford "Xmas Tree" Retainers	6827	Rubber Grommets	6853	Specialty Screws
6803	Chrysler "Xmas Tree" Retainers	6829	Honda Body Hardware	6854	Metric Specialty Screws
6804	GM Push-Type Retainers	6830	Hair Pin Cotters	6856	External & Internal Lock Washers
6805	Ford Push-Type Retainers	6831	Plastic Plug Buttons	6857	Thread Cutting & Washer Lock Nuts
6806	Nylon Rivets	6834	Toyota Body Hardware	6858	Pushnut Bolt Retainers
6807	Nylon Nuts	6835	Rubber O-Rings	6859	Hose Connectors
6808	License Plate Hardware	6836	Nylon Connectors	6861	Spring Pins
6809	Window Reveal Moulding Clips	6837	Honda Body Hardware	6862	E-Type Retaining Rings
6810	Sems® Screws	6838	Nissan Body Hardware	6863	External & Internal Retaining Rings
6811	Specialty Screws	6839	Toyota Body Hardware	6864	Door Lock Rod Clips
6812	Black Tapping Screws	6840	Pan'l Blind Rivets	6865	Weatherstrip Retainers
6813	Teks® Screws	6841	Specialty Rivets	6866	Rubber Bumpers
6814	Body Bolts	6842	Nylon Insulated Terminals	6867	Wire Loom Clips
6815	Tubular, Flat, U & J-Nuts	6843	Vinyl Insulated Terminals	6868	Shims
6816	Extruded U-Nuts	6845	GM "Xmas Tree" Retainers	6869	Fender Washers
6817	Washer Type Nuts & Push-On Retainers	6846	Ford "Xmas Tree" Retainers	6870	GM, Ford & Chrysler Push-Type Retainers
6818	Cotter Pins	6847	Chrysler "Xmas Tree" Retainers	6871	Hyundai & Kia Clips & Fasteners
6820	Oil Drain Plug Gaskets	6848	Chrome Phillips Oval Head Tapping Screws		
6821	Glass Shop Rivets	6850	Black Phillips Oval Head Tapping Screws		
6822	GM Window Guides	6851	Zinc & Black Phillips Pan Head Tapping Screws		
6825	Oil Drain Plug Gaskets				

Empty Compartment Boxes



Translucent Durable Polypropylene Boxes with Locking Tabs
6-3/4" Wide x 11" Deep x 1-3/4" High

6 Compartment Box

68-6: UNIT PACKAGE: 1

12 Compartment Box

68-12: UNIT PACKAGE: 1
68-112: UNIT PACKAGE: 10

18 Compartment Box

68-18: UNIT PACKAGE: 1
68-118: UNIT PACKAGE: 10

Quik-Select Rack



68-RACK

Empty Cabinet: Holds 5 Quik-Select Assortments.
11-1/4" Wide x 6-3/4" Deep x 10-3/4" High
Finish: Gray Enamel
Keyhole slots are furnished for wall mounting.
A handle is provided and bolt holes permits stacking.

UNIT PACKAGE: 1

Sec. 15

“6800” SERIES QUIK-SELECT ASSORTMENTS

Photos not actual size



6848

Phillips Oval Head Tapping Screws
Chrome Plated
18 Varieties - 200 Pieces

Auveco Part No.	Size
2698	#6 x 1/2"
1794	#6 x 3/4"
1796	#6 x 1"
2707	#8 x 1/2"
2027	#8 x 1/2" with #6 Head
2710	#8 x 3/4"
1799	#8 x 3/4" with #6 Head
2713	#8 x 1"
1483	#8 x 1" with #6 Head
2716	#8 x 1-1/4"
1423	#8 x 1-1/4" with #6 Head
2718	#8 x 1-1/2"
1932	#8 x 1-1/2" with #6 Head
1933	#8 x 1-3/4" with #6 Head
2728	#10 x 3/4"
1717	#10 x 3/4" with #8 Head
2731	#10 x 1"
2730	#10 x 1" with #8 Head



6850

Phillips Oval Head Tapping Screws
Black Oxide Plated
18 Varieties - 339 Pieces

Auveco Part No.	Size
12795	#6 x 1/2"
12796	#6 x 3/4"
12797	#6 x 1"
10163	#8 x 1/2"
10162	#8 x 1/2" with #6 Head
10165	#8 x 3/4"
10164	#8 x 3/4" with #6 Head
10167	#8 x 1"
10166	#8 x 1" with #6 Head
10169	#8 x 1-1/4"
10168	#8 x 1-1/4" with #6 Head
10171	#8 x 1-1/2"
10170	#8 x 1-1/2" with #6 Head
11086	#10 x 3/4"
11087	#10 x 3/4" with #8 Head
11088	#10 x 1"
11089	#10 x 1" with #8 Head
11092	#10 x 1-1/2"



6812

Black Tapping Screws
18 Varieties - 312 Pieces

Auveco Part No.	Size
Black E-Coat Phillips Flat Washer Head	
12213	#8 x 1/2"
12214	#8 x 5/8"
12215	#8 x 3/4"
12216	#8 x 1"
12217	#8 x 1-1/4"
12218	#8 x 1-1/2"
12953	#10 x 3/4"
12954	#10 x 1"
Black Oxide Phillips Oval Head	
10162	#8 x 1/2" with #6 Hd.
10163	#8 x 1/2"
10164	#8 x 3/4" with #6 Hd.
10165	#8 x 3/4"
10166	#8 x 1" with #6 Hd.
10167	#8 x 1"
10168	#8 x 1-1/4" with #6 Hd.
10169	#8 x 1-1/4"
10170	#8 x 1-1/2" with #6 Hd.
10171	#8 x 1-1/2"

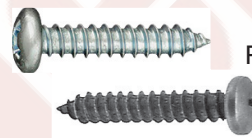

6851

Phillips Pan Head Tapping Screws
Plated
18 Varieties - 457 Pieces

Auveco Part No.	Size
Zinc	
1940	#8 x 1/2"
2365	#8 x 3/4"
3079	#8 x 1"
1943	#10 x 1/2"
2366	#10 x 3/4"
3082	#10 x 1"
2367	#12 x 3/4"
3090	#14 x 3/4"
Black Oxide	
11917	#6 x 1/2"
11918	#6 x 3/4"
10180	#8 x 1/2"
10181	#8 x 3/4"
10182	#8 x 1"
10183	#8 x 1-1/4"
12799	#8 x 1-1/2"
11921	#10 x 1/2"
11922	#10 x 3/4"
11923	#10 x 1"

"6800" SERIES QUIK-SELECT ASSORTMENTS

Photos not actual size

Sec. 15



6810

Sems® Screws
Plated
18 Varieties - 140 Pieces

Auveco Part No.	Size
Chrome	
3538	#6 x 3/4"
2771	#8 x 5/8" with #6 Hd.
2751	#8 x 3/4" with #6 Hd.
11450	#8 x 3/4", Tek
2775	#8 x 7/8" with #6 Hd., with Flush Washer
2772	#8 x 1" with #6 Hd.
2773	#8 x 1-1/4" with #6 Hd.
3465	#10 x 5/8" with #8 Hd.
3466	#10 x 3/4" with #8 Hd.
3467	#10 x 1" with #8 Hd.
Black	
11787	#8 x 5/8" with #6 Hd.
11454	#8 x 5/8", Tek
11788	#8 x 3/4" with #6 Hd.
11455	#8 x 3/4", Tek
11789	#8 x 1" with #6 Hd.
12957	#8 x 1" with #6 Hd. with Flush Washer
11791	#10 x 3/4" with #8 Hd.
11792	#10 x 1" with #8 Hd.



6813

Pan Head & Hex Washer
Head Tek® Screws
Zinc Plated
18 Varieties - 127 Pieces



Auveco Part No.	Size
Pan Head	
12095	#8 x 1/2"
9605	#8 x 1/2"
9606	#8 x 3/4"
9607	#10 x 1/2"
9608	#10 x 3/4"
9609	#10 x 1"
Hex Washer Head	
9611	#8 x 1/2"
9612	#8 x 3/4"
9613	#10 x 1/2"
9614	#10 x 5/8"
9615	#10 x 3/4"
9616	#10 x 1"
11911	#12 x 1"
11913	#12 x 1-1/2"
9620	#14 x 3/4"
11914	#14 x 1"
11915	#14 x 1-1/4"
11916	#14 x 1-1/2"



6852

Stainless Steel Tapping Screws
12 Varieties - 216 Pieces

Auveco Part No.	Size	Head
9400	#6 x 3/4"	Oval
9404	#8 x 3/4"	Oval
9405	#8 x 1"	Oval
9407	#8 x 1-1/2"	Oval
9409	#10 x 3/4"	Oval
9410	#10 x 1"	Oval
13269	#8 x 1/2"	Pan
13270	#8 x 3/4"	Pan
13271	#8 x 1"	Pan
13274	#10 x 1/2"	Pan
13275	#10 x 3/4"	Pan
13276	#10 x 1"	Pan



6811

Specialty Screws
12 Varieties - 332 Pieces

Auveco Part No.	Size
10642	#8 x 3/8"
2805	#8 x 7/16"
13025	#8 x 1/2"
12095	#8 x 1/2" Tek®
2806	#8 x 5/8"
13026	#8 x 3/4"
12739	M4.2-1.41 x 12mm
13712	M4.2-1.41 x 13mm
18340	M4.8-1.61 x 15mm
17459	M4.8-1.61 x 16mm
20259	M4.8-1.61 x 19mm
20455	M4.8-2.12 x 20mm



6808

License Plate Hardware
12 Varieties - 171 Pieces



Contains the following Auveco part numbers:
1313, 2472, 2625, 3182, 5228, 5278, 8250, 8427,
8435, 9603, 11370, 11719 & 14473.



6814

Body Bolts
12 Varieties - 101 Pieces

Auveco Part No.	Size
11320	5/16"-18 x 1"
12693	M6-1.0 x 20mm
12324	M6-1.0 x 20mm
12160	M6-1.0 x 22mm
12065	M6-1.0 x 25mm
12066	M6-1.0 x 25mm
12323	M6-1.0 x 25mm
12335	M6-1.0 x 28mm
12351	M6.3-1.81 x 20mm
13613	M8-1.25 x 25mm
13614	M8-1.25 x 30mm
11640	M8-1.25 x 30mm

Sec. 15

“6800” SERIES QUIK-SELECT ASSORTMENTS

Photos not actual size



6854

Metric Specialty Screws
18 Varieties - 145 Pieces

Auveco Part No.	Size
12062	M4.2-1.41 x 10mm
12739	M4.2-1.41 x 12mm
13712	M4.2-1.41 x 13mm
12741	M4.2-1.41 x 16mm
12060	M4.2-1.41 x 20mm
12738	M4.2-1.41 x 20mm
12742	M4.2-1.41 x 20mm
15373	M4.2-1.41 x 20mm
15775	M4.2-1.41 x 20mm
17459	M4.8-1.81 x 16mm
12057	M6.3-1.81 x 16mm
15962	M6.3-1.81 x 18mm
12351	M6.3-1.81 x 20mm
16828	M6.3-1.81 x 20mm
12339	M6.3-1.81 x 25mm
12068	M6.3-1.81 x 30mm
12354	M6.3-1.81 x 30mm
12350	M8-2.12 x 20mm



6853

Specialty Screws
12 Varieties - 198 Pieces

Auveco Part No.	Size
10642	#8 x 3/8"
15037	#8 x 7/16"
2805	#8 x 7/16"
12095	#8 x 1/2"
15172	#8 x 1/2"
15774	#8 x 1/2"
2806	#8 x 5/8"
12820	#8 x 3/4"
13026	#8 x 3/4"
17650	#8 x 3/4"
13709	#10 x 3/4"
16589	#10 x 3/4"

DON'T SEE THE ASSORTMENT YOU WANT?

Although we offer over 100 different assortments, we know you have some great ideas for new ones.

Send us those ideas so we make sure our customers get the best we can offer.

Email suggestions to mail@auveco.com



6858

Pushnut Bolt Retainers
18 Varieties - 314 Pieces

Auveco Part No.	Size
16851	#6 (9/64")
10085	#8 (5/32")
16852	#10 (3/16")
10086	1/4"
10087	5/16"
9297	3/8"
9298	7/16"
9299	1/2"
12122	M5-0.8
12123	M6-1.0
14980	M6-1.0
12124	M6.3-1.0
12125	M8-1.25
12259	M8-1.25
12126	M10-1.50
12260	M10-1.50
12127	M12-1.75
16980	M14-2.0



6817

Washer Type
Thread Cutting Nuts
& Push-on Retainers
18 Varieties - 385 Pieces

Auveco Part No.	Size
Thread Cutting Nuts	
12253	5mm Stud Size
3403	1/8" Stud Size
3404	3/16" Stud Size
2896	3/16" Stud Size
2897	1/4" Stud Size
3405	1/4" Stud Size
10733	5/16" Stud Size
Push-On Retainers	
8863	1/8" Stud Size
8864	5/32" Stud Size
8865	3/16" Stud Size
8868	1/4" Stud Size
Bolt Retainers	
10086	1/4" Bolt Size
10087	5/16" Bolt Size
9297	3/8" Bolt Size
12123	6mm Bolt Size
12125	8mm Bolt Size
12259	8mm Bolt Size
12126	10mm Bolt Size

"6800" SERIES QUIK-SELECT ASSORTMENTS

Photos not actual size

Sec. 15



6816

Extruded U-Nuts (Foldover Nuts)
12 Varieties - 70 Pieces

Auveco Part No.	Size	Center of Hole to Edge
8359	1/4" - 20	17/32"
10051	1/4" - 20	25/32"
10053	5/16" - 18	9/16"
8814	5/16" - 18	27/32"
10054	3/8" - 16	3/4"
10055	3/8" - 16	1-1/8"
12669	M6 - 1.0	13.5mm
12575	M6 - 1.0	19.5mm
11628	M6.3 - 1.0	13.5mm
11629	M8 - 1.25	14.5mm
11630	M8 - 1.25	20mm
11631	M10 - 1.5	19mm



6857

Thread Cutting & Washer Lock Nuts
18 Varieties - 227 Pieces



Auveco Part No.	Size
Thread Cutting Nuts	
2895	1/8" Stud Size
3403	1/8" Stud Size
8855	5/32" Stud Size
2896	3/16" Stud Size
3404	3/16" Stud Size
3405	1/4" Stud Size
2897	1/4" Stud Size
10733	5/16" Stud Size
12253	5mm Stud Size
12255	6.3mm Stud Size
15711	8mm Stud Size
Washer Lock Nuts	
2554	#6-32 Thread
2555	#8-32 Thread
2557	#10-24 Thread
2558	#10-24 Thread
2560	#12-24 Thread
2561	1/4"-20 Thread
2562	1/4"-20 Thread



6869

Fender Washers
12 Varieties - 155 Pieces

Auveco Part No.	Bolt Size	Outer Diameter
2007	3/16"	1/2"
1183	3/16"	3/4"
16018	3/16"	1"
16020	1/4"	1"
2333	1/4"	1-1/4"
768	5/16"	1-1/4"
17095	5/16"	1-1/4"
1700	5/16"	1-1/2"
3553	3/8"	1-1/4"
2227	3/8"	1-1/2"
1294	3/8"	1-3/4"
17094	3/8"	1-3/4"

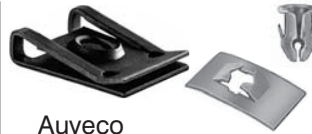

6815

Nuts: Tubular, Flat, J & U
18 Varieties - 148 Pieces

Auveco Part No.	Size	Type
2595	1/8"	Tubular
10073	3/16"	Tubular
2099	1/8"	Flat
2092	#10-24	Flat
1903	1/4"-20	Flat
5586	1/4"-20	J-Nut
5589	5/16"-18	J-Nut
5170	3/8"-16	J-Nut
10666	#8	U-Nut
11292	#8	U-Nut
5197	#10-24	U-Nut
2293	1/4"-20	U-Nut
9879	#8	U-Nut
9880	#8	U-Nut
10064	#6	U-Nut
10065	#8	U-Nut
10066	#10	U-Nut
10067	#14	U-Nut



6856

External & Internal Lock Washers
12 Varieties - 685 Pieces



Auveco Part No.	Size
External	
5251	#8 (5/32")
5252	#10 (3/16")
5254	#14 (1/4")
5255	5/16"
5256	3/8"
5257	7/16"
Internal	
5261	#8 (5/32")
5262	#10 (3/16")
5264	#14 (1/4")
5265	5/16"
5266	3/8"
5267	7/16"



6868

Shims - Zinc Plated
6 Varieties - 100 Pieces

Auveco Part No.	Size	Thickness
2453	1-3/4" x 1-1/4"	1/8"
3000	2" x 1-1/2"	1/8"
3155	1-1/4" x 1-1/8"	1/16"
3156	1-1/4" x 1-1/8"	1/8"
5076	1-1/8" x 1-1/8"	1/16"
5077	1-1/8" x 1-1/8"	1/8"

Sec. 15

“6800” SERIES QUIK-SELECT ASSORTMENTS

Photos not actual size



6830
Hair Pin Cotters
6 Varieties - 73 Pieces

Auveco Part No.	Overall Length
10397	3-15/16"
11872	1-9/16"
10398	4"
10395	2-1/2"
10396	3-3/4"
10394	2-5/16"



6818
Cotter Pins
Zinc Plated
18 Varieties - 570 Pieces

Auveco Part No.	Size
8477	1/16" x 1/2"
8478	1/16" x 3/4"
8479	1/16" x 1"
8480	1/16" x 1-1/2"
8481	3/32" x 3/4"
8482	3/32" x 1"
8484	3/32" x 1-1/2"
8485	3/32" x 2"
8486	1/8" x 1"
8487	1/8" x 1-1/4"
8488	1/8" x 1-1/2"
8489	1/8" x 1-3/4"
8490	1/8" x 2"
8492	5/32" x 1"
8493	5/32" x 1-1/2"
8494	5/32" x 2"
8495	3/16" x 1-1/2"
8496	3/16" x 2"



6863
External & Internal Retaining Rings
Zinc Plated
18 Varieties - 151 Pieces



Auveco Part No.	Shaft Diameter
Internal Type	
8688	1/4"
8689	5/16"
8690	3/8"
8691	7/16"
8693	9/16"
8694	5/8"
External Type	
8701	1/4"
8702	5/16"
8703	3/8"
8704	7/16"
8705	1/2"
8706	9/16"
8707	5/8"
8708	3/4"
8709	7/8"
8710	1"
8712	1-1/4"
10125	1-1/2"



6831
Plastic Plug Buttons
6 Varieties - 305 Pieces



Auveco Part No.	Size
Depressed Center Type	
9288	1/2"
9289	3/4"
Flush Type	
14923	3/8"
11746	1/2"
11747	3/4"
11749	1"



6862
E-Type Retaining Rings
12 Varieties - 343 Pieces

Auveco Part No.	Shaft Diameter
8825	3/32"
8826	1/8"
10131	5/32"
8827	3/16"
10133	7/32"
8828	1/4"
3824	5/16"
8829	3/8"
8830	7/16"
5602	1/2"
5603	5/8"
8831	3/4"



6861
Spring Pins
Zinc Plated
12 Varieties - 174 Pieces

Auveco Part No.	Size
9006	1/8" x 3/4"
9008	1/8" x 1"
9010	1/8" x 1-1/2"
9016	5/32" x 1"
9018	5/32" x 1-1/2"
9022	3/16" x 1"
9024	3/16" x 1-1/2"
9026	3/16" x 2"
9033	1/4" x 1"
9035	1/4" x 1-1/2"
9037	1/4" x 2"
9045	5/16" x 2"



6826
Rubber Vacuum Caps
6 Varieties - 121 Pieces



Auveco Part No.	Size
12209	Fits 1/8" O.D. Tube
4440	Fits 3/16" O.D. Tube
4439	Fits 1/4" O.D. Tube
12907	Fits 5/16" O.D. Tube
12210	Fits 3/8" O.D. Tube
12908	Fits 1/2" O.D. Tube

"6800" SERIES QUIK-SELECT ASSORTMENTS

Photos not actual size

Sec. 15

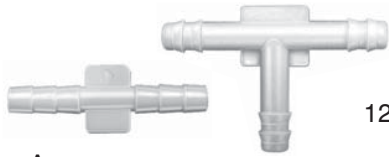

6836
Nylon Connectors
12 Varieties - 83 Pieces

Auveco Part No.	Size	Type
11738	1/4" x 1/4" x 3/16"	Tee
12918	3/16 x 3/16" x 3/16"	Tee
12919	1/4" x 3/16" x 3/16"	Tee
12920	5/16" x 5/16" x 5/16"	Tee
12921	3/8" x 3/8" x 1/4"	Tee
12923	1/8" x 1/8" x 1/8"	Tee
12926	3/16" x 3/16" x 1/8"	Tee
12929	1/8" x 1/8"	Straight
12930	1/8" x 3/16"	Straight
12931	1/4" x 1/4"	Straight
12935	1/4" x 3/16"	Straight
12937	3/16" x 3/16"	Straight



6867
Wire Loom Routing Clips
6 Varieties - 42 Pieces

Auveco Part No.	For Loom Size
14544	11/32" I.D., 1/2" O.D.
14545	13/32" I.D., 19/32" O.D.
14546	1/2" I.D., 11/16" O.D.
14547	3/4" I.D., 1" O.D.
16941	1" I.D., 1-9/32" O.D.
19440	1/4" I.D., 3/8" O.D.



6825
Oil Drain Plug Gaskets
12 Varieties - 84 Pieces



Auveco Part No.	Size	Type
8277	1/2"	Nylon
15918	1/2"	Copper
15919	9/16"	Copper
16026	1/2"	Steel & Rubber
16682	14mm	Fibre
16955	18mm	Aluminum
16956	14mm	Aluminum
16996	1/2"	Nylon
18299	14mm	Steel & Rubber
18665	11mm	Rubber
18726	12mm	Fibre
19630	11mm	Rubber



6820
Oil Drain Plug Gaskets
12 Varieties - 120 Pieces



Auveco Part No.	Size	Type
8277	1/2"	Nylon
8278	5/8"	Nylon
8279	3/4"	Nylon
8281	9/16"	Nylon
16680	12mm	Nylon
16681	14mm	Nylon
16682	14mm	Fibre
16685	20mm	Nylon
16996	1/2"	Nylon
21647	20mm	Fibre
18019	1/2"	Fibre
18726	12mm	Fibre



6859
Hose Connectors
12 Varieties - 61 Pieces

Auveco Part No.	Size	Type
10101	1/8" x 1/8"	Straight
10102	3/16" x 3/16"	Straight
10103	1/4" x 1/4"	Straight
10104	5/16" x 5/16"	Straight
10105	3/8" x 3/8"	Straight
10106	1/4" x 3/16"	Straight
10107	3/8" x 1/4"	Straight
10697	1/8" x 1/8" x 1/8"	Tee
10108	5/32" x 5/32" x 5/32"	Tee
10109	3/16" x 3/16" x 3/16"	Tee
10110	1/4" x 1/4" x 1/4"	Tee
11228	3/8" x 3/8" x 3/8"	Tee



6843
Vinyl Insulated
Solderless Terminals
12 Varieties - 125 Pieces

Auveco Part No.	Description
5023	Ring Type, 22-18 Gauge
5026	Ring Type, 16-14 Gauge
5027	Ring Type, 16-14 Gauge
5028	Ring Type, 12-10 Gauge
5029	Ring Type, 12-10 Gauge
5031	Ring Type, 12-10 Gauge
5036	Spade Type, 16-14 Gauge
5047	Butt Conn., 22-18 Gauge
5048	Butt Conn., 16-14 Gauge
5049	Butt Conn., 12-10 Gauge
12144	Ring Type, 16-14 Gauge
17037	Butt Connector, 8 Gauge

Sec. 15

“6800” SERIES QUIK-SELECT ASSORTMENTS

Photos not actual size

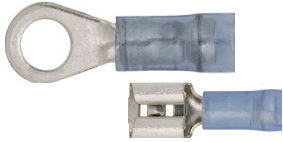

6842
Nylon Insulated
Solderless Terminals
12 Varieties - 100 Pieces

Auveco Part No.	Description
5791	Butt Conn., 22-18 Gauge
5792	Butt Conn., 16-14 Gauge
5793	Butt Conn., 12-10 Gauge
9055	Ring Type, 16-14 Gauge
9056	Ring Type, 16-14 Gauge
9060	Spade Type, 16-14 Gauge
12147	Male Q. C. 16-14 Gauge
12148	Female Q.C., 16-14 Gauge
12150	Ring Type, 22-18 Gauge
12151	Ring Type, 12-10 Gauge
12152	Ring Type, 12-10 Gauge
12153	Ring Type, 12-10 Gauge



6840
Pan'l Blind Rivets
12 Varieties - 291 Pieces

Auveco Part No.	Grip	Type
1/8 Diameter		
8309	1/16"-1/8"	Aluminum
5753	3/16"-1/4"	Steel
8925	3/16"-1/4"	Aluminum
8931	3/16"-1/4"	Aluminum Large Flange
8880	5/16"-3/8"	Steel
16031	5/16"-3/8"	Aluminum
16032	3/8"-1/2"	Aluminum
3/16" Diameter		
5755	1/16"-1/8"	Aluminum
8311	1/8"-1/4"	Aluminum
8301	1/4"-3/8"	Aluminum
8313	1/4"-3/8"	Aluminum Large Flange
8938	3/8"-1/2"	Aluminum



6841
Specialty Rivets
12 Varieties - 66 Pieces

Auveco Part No.	Grip	Type
1/8" Diameter		
16834	1/8"-3/16"	
17615	3/16"-3/8"	
3/16" Diameter		
16864	3/64"-11/32"	
17121	5/64"-15/64"	
14127	3/8"-1/2"	
1/4" Diameter		
11620	1/32"-9/64"	Peel-Type
12653	3/32"-1/8"	Peel-Type
18167	3/32"-9/64"	Peel-Type
12652	1/8"-1/4"	
12655	9/64"-3/16"	Peel-Type
17639	3/16"-3/8"	
11621	33/64"-19/32"	Peel-Type



6806
Nylon Rivets
12 Varieties
74 Pieces

Auveco Part No.	Diameter	Grip
13746	3/16"	1/16"-9/64"
13747	13/64"	1/16"-11/64"
13748	13/64"	1/8"-15/64"
13755	13/64"	15/64"-25/64"
14004	15/64"	11/64"-11/32"
14023	15/64"	5/32"-5/16"
18108	1/4"	5/32"-3/8"
13750	1/4"	5/32"-13/32"
13751	1/4"	5/32"-13/32"
17101	1/4"	5/16"-15/32"
13752	17/64"	3/32"-3/16"
13753	17/64"	3/32"-3/16"



6827
Rubber Grommets
18 Varieties - 99 Pieces

Auveco Part No.	Bore Diameter	Width
4408	1/8"	3/32"
4410	5/32"	1/16"
4413	3/16"	1/16"
4414	3/16"	3/32"
4415	3/16"	1/4"
4417	1/4"	1/16"
4419	5/16"	1/16"
4421	5/16"	1/8"
4422	5/16"	1/4"
4423	3/8"	1/16"
4425	3/8"	1/16"
4426	3/8"	1/4"
4428	1/2"	3/32"
4430	1/2"	1/4"
4431	5/8"	1/8"
4432	5/8"	1/16"
4434	3/4"	1/16"
4436	3/4"	1/4"



6821
Glass Shop Rivets
6 Varieties - 63 Pieces

Auveco Part No.	Diameter	Grip
11620	1/4"	1/32"-9/64"
11621	1/4"	33/64"-19/32"
11852	1/4"	5/64"-7/64"
12653	1/4"	3/32"-1/8"
12655	1/4"	9/64"-3/16"
16834	1/8"	1/8"-3/16"

"6800" SERIES QUIK-SELECT ASSORTMENTS

Sec. 15

Photos not actual size



6835

Rubber O-Rings
Buna-N
18 Varieties - 770 Pieces

Auveco Part No.	Industry Standard	Inner Diameter	Outer Diameter
4305	006	1/8"	1/4"
4306	007	5/32"	9/32"
4307	008	3/16"	5/16"
4308	009	7/32"	11/32"
4309	010	1/4"	3/8"
4310	011	5/16"	7/16"
4311	012	3/8"	1/2"
4312	110	3/8"	9/16"
4313	111	7/16"	5/8"
4314	112	1/2"	11/16"
4315	113	9/16"	3/4"
4316	114	5/8"	13/16"
4317	115	11/16"	7/8"
4318	116	3/4"	15/16"
4319	210	3/4"	1"
4320	211	13/16"	1-1/16"
4321	212	7/8"	1-1/8"
4323	214	1"	1-1/4"



6866

Rubber Bumpers
12 Varieties
105 Pieces

Auveco Part No.	Application
4155	General Purpose
4188	Door & Quarter Glass
4233	General Purpose
4235	Hood & Fender
4237	General Purpose
4240	Door
4242	Hood, Trunk & Deck Lid
4244	General Purpose
4246	Gas Tank Lid
4249	General Purpose
4250	Glove Box Door
4280	License Plate



6809

Window Reveal Moulding Clips
GM & Ford
12 Varieties - 132 Pieces

Contains the following Auveco part numbers:
8583, 8941, 9633 9639, 9882, 10243, 10630, 10631
11067, 11152, 11345 & 13564.



6801

GM "Xmas Tree" Retainers
12 Varieties - 118 Pieces

Contains the following Auveco part numbers:
10621, 10831, 10832, 11146, 11612,
11678, 11796, 12137, 12731,
12737, 12766 & 12992.



6802

Ford "Xmas Tree" Retainers
12 Varieties - 112 Pieces

Contains the following Auveco part numbers:
10831, 11136, 11351, 11671, 11797, 12565,
12571, 12909, 14021, 14163, 17612 & 19655



6803

Chrysler "Xmas Tree Retainers
6 Varieties - 113 Pieces

Contains the following Auveco part numbers:
10831, 11136, 11146, 11351, 11678 & 17004



6822

GM Window Guides
6 Varieties - 30 Pieces

Auveco Part No.	O.E.M. No.
15462	20478733
15463	20487630, 20712176
15466	20160591
15467	20123070, 20328600
17159	20747509
17176	20162174, 22543363



6845

GM "Xmas Tree" Retainers
11 Varieties - 118 Pieces

Contains the following Auveco part numbers:
11120, 12759, 13461, 14032, 14036, 15367,
15456, 15669, 15970, 16818 & 17664



6846

Ford "Xmas Tree" Retainers
12 Varieties - 112 Pieces

Contains the following Auveco part numbers:
8853, 11136, 11672, 13470, 14757, 15478,
15479, 15480, 17102, 17339, 19655 & 20316



6847

Chrysler "Xmas Tree" Retainers
12 Varieties - 113 Pieces

Contains the following Auveco part numbers:
11129, 11136, 11675, 11679, 14921, 15481,
15543, 16818, 17004, 17975, 18033 & 20316

Sec. 15

“6800” SERIES QUIK-SELECT ASSORTMENTS

Photos not actual size



6864

Door Lock Rod Clips
12 Varieties - 59 Pieces



Contains the following Auveco part numbers:
14967, 15518, 15673, 15674, 15675, 15759, 17069,
17122, 18392, 18393, 18926 & 20675



6807

Nylon Nuts & Grommets
18 Varieties - 251 Pieces



Contains the following Auveco part numbers:
2625, 3682, 8435, 9829, 9862, 10330, 11368, 11691,
11719, 11838, 11841, 11855, 12735, 13450,
13933, 13960, 14009 & 14031



6865

Weatherstrip Retainers
12 Varieties - 245 Pieces

Auveco Part No.	Application
8853	Ford
10744	GM
11120	GM
11129	Chrysler
11612	Ford & GM
14328	Honda
14921	Chrysler & GM
17339	Ford
18033	Chrysler
18692	Mazda & Toyota
18877	Honda
19171	Honda



6804

GM Push-type Retainers
12 Varieties - 76 Pieces

Contains the following Auveco part numbers:
12567, 12757, 13993, 14010, 14011,
14020, 14753, 15044, 15045, 17216,
17222 & 18353.



6829

Honda Body Hardware
12 Varieties - 92 Pieces

Auveco Part No.	Description
14268	Screw Grommet
14274	Nylon Nut
14282	Retaining Clip
14313	Nylon Nut
14695	Screw Grommet
14696	Push-Type Retainer
14697	Push-Type Retainer
14698	Push-Type Retainer
16000	Push-Type Retainer
17143	Push-Type Retainer
17144	Push-Type Retainer
20564	Push-Type Retainer



6805

Ford Push-Type Retainers
6 Varieties - 68 Pieces

Contains the following Auveco part numbers:
11705, 14018, 14019, 14020,
14753 & 18894.



6837

Honda Body Hardware
12 Varieties - 61 Pieces

Auveco Part No.	Description
14289	Panel Retainer
14291	Retaining Clip
14328	Weatherstrip Clip
16779	Retaining Clip
16782	Push-Type Retainer
17057	Push-Type Retainer
17192	Push-Type Retainer
17205	Retaining Clip
17379	Push-Type Retainer
18114	Insulation Retainer
18119	Push-Type Retainer
19233	Push-Type Retainer



6870

GM, Ford & Chrysler Push-Type Retainers
11 Varieties - 116 Pieces

Contains the following Auveco part numbers:
20826, 20880, 20888, 20889, 20988, 20989,
20990, 20991, 20992, 20993 & 20994.

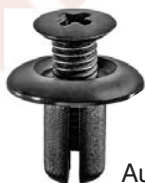

6871

Hyundai & Kia
Clips & Fasteners
18 Varieties - 76 Pieces

Auveco Part No.	Description
20543	Hood Insulation Retainer
20566	Moulding Clip
20567	Moulding Clip
20568	Moulding Clip
20680	M6-1.0 L. P. Screw
21064	Moulding Clip
21067	Bumper & Grille Retainer
21068	Nylon Nut
21070	Trim Panel Retainer
21136	Moulding Clip
21146	Push-Type Retainer
21188	Trim Panel Retainer
21244	Moulding Clip
21312	Moulding Clip
21321	Moulding Clip
21328	Push-Type Retainer
21378	Nylon U-Nut
21382	Cowl Vent & Grille Retainer

"6800" SERIES QUIK-SELECT ASSORTMENTS

Sec. 15

Photos not actual size

Auveco Part No.	Description
6838	Nissan Body Hardware 12 Varieties 58 Pieces
14352	Retaining Clip
14355	Retaining Clip
16775	Trim Panel Retainer
16776	Trim Panel Retainer
16782	Push-Type Retainer
16783	Push-Type Retainer
16843	Push-Type Retainer
17347	Push-Type Retainer
17452	Retaining Clip
17472	Push-Type Retainer
20327	Push-Type Retainer
20348	Push-Type Retainer

Auveco Part No.	Description
6839	Toyota Body Hardware 12 Varieties - 73 Pieces
14144	Trim Panel Retainer
14271	Nylon Nut
15695	Retainer
16779	Retaining Clip
17206	Push-Type Retainer
17438	Grille Clip
18297	Retaining Clip
18873	Push-Type Retainer
18888	Push-Type Retainer
19739	Push-Type Retainer
20390	Moulding Clip
20391	Moulding Clip

Auveco Part No.	Description
6834	Toyota Body Hardware 18 Varieties - 72 Pieces
13932	Nylon Nut
14260	Push-Type Retainer
14265	Nylon Nut
14267	Screw Grommet
14268	Screw Grommet
14269	Panel Retainer
14274	Nylon Nut
14275	Screw Grommet
14276	Nylon U-Nut
14695	Screw Grommet
14736	Retaining Clip
14737	Retaining Clip
14738	Retaining Clip
14750	Nylon U-Nut
16306	Bumper Cushion Clip
16784	Push-Type Retainer
19194	Screw Grommet
19721	Screw Grommet

Please place orders in Unit Package quantities, not based on pieces needed

ASSORTMENTS

*All assortments come in durable translucent polypropylene boxes
Photos not actual size*

	19442 Extension Springs Zinc Plated 6 Varieties - 38 Pieces
Contains the following Auveco part numbers: 14063, 14064, 14065 14067, 14070 & 14072	

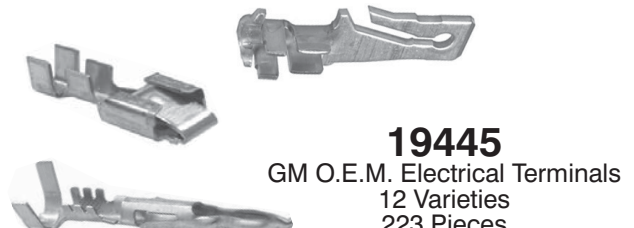
	19445 GM O.E.M. Electrical Terminals 12 Varieties 223 Pieces
Contains the following Auveco part numbers: 8774, 8776, 14150, 14151, 14152, 14880, 14881, 14883, 15497, 15498, 15937 & 15948.	

Sec. 15

ASSORTMENTS

All assortments come in durable translucent polypropylene boxes
Photos not actual size



21534

Krimp and Seal Terminals & Connectors
24 Varieties - 159 Pieces

Auveco Part No.	Description
13656	Ring Type, 22-18 Gauge
13657	Ring Type, 22-18 Gauge
13658	Spade Type, 22-18 Gauge
13659	Butt Conn., 22-18 Gauge
13660	Female Q.C., 22-18 Gauge
13661	Male Q.C., 22-18 Gauge
13662	Ring Type, 16-14 Gauge
13663	Ring Type, 16-14 Gauge
13664	Ring Type, 16-14 Gauge
13665	Ring Type, 16-14 Gauge
13666	Ring Type, 16-14 Gauge
13669	Butt Conn., 16-14 Gauge
13670	Female Q.C., 16-14 Gauge
13671	Male Q.C., 16-14 Gauge
13672	Female Q.C., 16-14 Gauge
13673	Male, Q.C., 16-14 Gauge
13674	Ring Type, 12-10 Gauge
13675	Ring Type, 12-10 Gauge
13676	Ring Type, 12-10 Gauge
13678	Butt Conn., 12-10 Gauge
13679	Female Q.C., 12-10 Gauge
13680	Male Q.C., 12-10 Gauge
13681	Female Plug, 16-14 Gauge
13682	Male Plug, 16-14 Gauge



19443

U.S. Grease Fittings
Plated
12 Varieties - 92 Pieces



Auveco Part No.	Type
9257	1/4"-28, Straight (Short)
9258	1/4"-28, Straight (Long)
9259	1/4"-28, Straight (Extra-Long)
9260	1/4"-28, 45 Degree
9261	1/4"-28, 90 Degree
9262	1/8" Pipe, Straight (Short)
9267	1/8" Pipe, Straight (Long)
15066	1/8" Pipe, Straight (Self-Tapping)
9264	1/8" Pipe, 45 Degree
9265	1/8" Pipe, 65 Degree
9266	1/8" Pipe, 90 Degree
15059	1/4" Pipe, Straight



19927

Copper Washers
6 Varieties - 150 Pieces

Auveco Part No.	Bolt Size	Outer Diameter
15915	1/4"	11/16"
15913	5/16"	9/16"
15916	5/16"	3/4"
15917	3/8"	13/16"
15918	7/16"	7/8"
15919	1/2"	13/16"



21471

Oil Drain Plugs & Gaskets
12 Varieties - 24 Pieces



Auveco Part No.	Size
14196	1/2"-20 x 1/2"
18373	1/2"-20 x 13/16"
18374	M12-1.75 x 21mm
21047	M12-1.75 x 25mm
14677	M12-1.75 x 26mm
16308	M14-1.5 x 11mm
18375	M14-1.5 x 18mm
14678	M14-1.5 x 20mm
19141	M14-1.5 x 20mm
19279	M14-1.5 x 20mm
19773	M14-1.5 x 20mm
15529	M18-1.5 x 12mm



19444

Metric Grease Fittings
Plated
12 Varieties - 89 Pieces



Auveco Part No.	Type
11097	6mm-1.00, Straight
11775	6mm-1.00, 45 Degree
11776	6mm-1.00, 90 Degree
11098	8mm-1.00, Straight
11777	8mm-1.00, 45 Degree
11099	8mm-1.00, 90 Degree
11778	8mm-1.25, Straight
11779	8mm-1.25, 45 Degree
11780	8mm-1.25, 90 Degree
11100	10mm-1.00, Straight
15067	10mm-1.00, 45 Degree
11101	10mm-1.00, 90 Degree



17359

Door Hinge Bushings
8 Varieties - 136 Pieces



Auveco Part No.	Application
14548	GM
14549	GM
14550	GM, Ford
14551	Ford
14552	Chrysler
14553	GM
16936	GM
16937	GM

17358

GM Door Hinge Pins
5 Varieties - 27 Pieces



Contains the following Auveco part numbers:
14559, 17437, 19183, 19424 & 19781

"FP" 4 PACK ASSORTMENTS

Photos not actual size



The Auveco "FP" 4 pack assortments are packed in a four compartment easy open translucent polypropylene box. Each assortment contains four carefully selected items designed for the customer that requires maximum coverage for minimum investment.

"FP" 4 Pack Numeric Listing

Refer to contents listing on following pages

Auveco Part No.	Description
FP-100	Phillips Oval Head Tapping Screws, Chrome
FP-102	Phillips Oval Head Tapping Screws, Chrome
FP-104	Phillips Oval Head Tapping Screws, Chrome
FP-108	Phillips Oval Head Tapping Screws, Chrome
FP-123	Phillips Oval Head Sems® Screws, Chrome
FP-131	Hex Washer Head Tapping Screws
FP-132	Hex Washer Head Tapping Screws
FP-159	Washer Lock Nuts
FP-160	Thread Cutting Nuts
FP-163	Tubular Nuts
FP-164	Tubular Nuts
FP-168	J & U Nuts
FP-169	J-Type Cage Nuts
FP-171	Flat Washers

Auveco Part No.	Description
FP-178	Shims
FP-179	Shims
FP-183	Cotter Pins
FP-188	Plug Buttons
FP-193	Grease Fittings
FP-194	Grease Fittings
FP-210	Universal Moulding Fasteners
FP-224	Phillips Oval Head Tapping Screws, B. Oxide
FP-232	Phillips Oval Head Sems® Screws, Phos.
FP-233	Phillips Flat Washer Head Tapping Screws, Black E-Coat
FP-243	Push-On Retainers
FP-247	Spring Type U-Nuts

FP-100
Phillips Oval Head Tapping Screws
Chrome
150 Pieces



Auveco Part No.	Size
1794	6 x 3/4"
2698	6 x 1/2"
1796	6 x 1"
1797	6 x 1-1/4"

FP-108
Phillips Oval Head Tapping Screws
No. 8 Head - Chrome
115 Pieces



Auveco Part No.	Size
2724	10 x 5/8"
1717	10 x 3/4"
2730	10 x 1"
2734	10 x 1-1/4"

FP-102
Phillips Oval Head Tapping Screws
Chrome
140 Pieces



Auveco Part No.	Size
2707	8 x 1/2"
2710	8 x 3/4"
2713	8 x 1"
2716	8 x 1-1/4"

FP-224
Phillips Oval Head Tapping Screws
Black Oxide
245 Pieces



Auveco Part No.	Size
10163	8 x 1/2"
10165	8 x 3/4"
10167	8 x 1"
10169	8 x 1-1/4"

FP-104
Phillips Oval Head Tapping Screws
No. 6 Head - Chrome
130 Pieces



Auveco Part No.	Size
2027	8 x 1/2"
1799	8 x 3/4"
1483	8 x 1"
1423	8 x 1-1/4"

FP-123
Phillips Oval Head Sems® Tapping Screws
Chrome
90 Pieces



Auveco Part No.	Size
2771	8 x 5/8"
2751	8 x 3/4"
2772	8 x 1"
3466	10 x 3/4"

Sec. 15

“FP” 4 PACK ASSORTMENTS

Photos not actual size



FP-232

Phillips Oval Head Sems® Tapping Screws
Black Phosphate
100 Pieces

Auveco Part No.	Size
11788	8 x 3/4"
11789	8 x 1"
11791	10 x 3/4"
11792	10 x 1"



FP-233

Phillips Flat Washer Head Tapping Screws
Black E-Coat
220 Pieces

Auveco Part No.	Size
12213	8 x 1/2"
12214	8 x 5/8"
12215	8 x 3/4"
12216	8 x 1"



FP-131

Hex Washer Head Tapping Screws
Zinc
165 Pieces

Auveco Part No.	Size
2369	10 x 1/2"
2809	10 x 5/8"
2967	12 x 5/8"
2968	12 x 3/4"



FP-132

Hex Washer Head Tapping Screws
Zinc
75 Pieces

Auveco Part No.	Size
2370	14 x 5/8"
2330	14 x 3/4"
2974	14 x 1"
2978	5/16" x 3/4"



FP-243

Push-On Retainers
Zinc
260 Pieces

Auveco Part No.	Stud Size	Outer Diameter
8863	1/8"	3/8"
8865	3/16"	7/16"
8868	1/4"	17/32"
8869	5/16"	5/8"



FP-159

Washer Lock Nuts
Zinc
240 Pieces

Auveco Part No.	Thread Size	Outer Diameter
2555	8-32	15/32"
2556	10-32	1/2"
2557	10-24	1/2"
2558	10-24	3/4"



FP-160

Thread Cutting Nuts
Zinc
125 Pieces

Auveco Part No.	Stud Size	O.D.
3403	1/8"	7/16"
2895	1/8"	17/32"
2896	3/16"	5/8"
2897	1/4"	19/32"



FP-168

J and U-Type Nuts
48 Pieces

Auveco Part No.	Screw Size
1907	5/16"-10
2057	#14
2420	#14
2293	1/4"-20



FP-169

J-Type Cage Nuts
28 Pieces

Auveco Part No.	Thread Size
5589	5/16"-18
5170	3/8"-16
5586	1/4"-20



FP-163

Tubular Nuts
80 Pieces

Auveco Part No.	Stud Size
2611	1/8"
11293	1/8"
3776	3/32"
2565	3/16"

"FP" 4 PACK ASSORTMENTS

Photos not actual size



FP-164
Tubular Nuts
75 Pieces

Auveco Part No.	Stud Size
2595	1/8"
3137	3/32"
10073	3/16"
5196	1/4"



FP-247
Spring Type U-Nuts
Phosphate
70 Pieces

Auveco Part No.	Screw Size
10064	#6
10065	#8
10066	#10
10067	#14



FP-171
Fender Washers
Zinc Plated
200 Pieces

Auveco Part No.	Bolt Size	Outer Diameter
1183	3/16"	3/4"
2333	1/4"	1-1/4"
768	5/16"	1-1/4"
3553	3/8"	1-1/4"



FP-210
Universal Moulding
Fasteners with Nuts
18 Moulding Fasteners

Contains the following Auveco Part Numbers:
2818, 2619, 2752 & 19626.



FP-178
Shims - Plated
75 Pieces

Auveco Part No.	Size	Thickness	Slot
3155	1-1/4" x 1-1/8"	1/16"	3/8"
3156	1-1/4" x 1-1/8"	1/8"	3/8"
2452	1-3/4" x 1-1/4"	1/16"	1/2"
2453	1-3/4" x 1-1/4"	1/8"	1/2"



FP-179
Caster & Camber Shims
Plated
65 Pieces

Auveco Part No.	Thickness	Size
5074	1/64"	1-1/8" x 1-1/8"
5075	1/32"	1-1/8" x 1-1/8"
5076	1/16"	1-1/8" x 1-1/8"
5077	1/8"	1-1/8" x 1-1/8"



FP-183
Hammer Lock
Cotter Pins
Plated
240 Pieces

Auveco Part No.	Size
8482	3/32" x 1"
8484	3/32" x 1-1/2"
8488	1/8" x 1-1/2"
8490	1/8" x 2"



FP-188
Plug Buttons
Nickel Plated
37 Pieces

Auveco Part No.	Hole Size
3751	3/8"
3752	1/2"
3753	5/8"
3755	7/8"



FP-193
Ball Check Grease Fittings
34 Pieces

Auveco Part No.	Size
9257	1/4"-28 Short
9258	1/4"-28 Long
9259	1/4"-28 Extra Long
9262	1/8" Pipe Thread



FP-194
Ball Check
Grease Fittings
22 Pieces

Auveco Part No.	Size	Type
9260	1/4"-28	45°
9261	1/4"-28	90°
9264	1/8" Pipe	45°
9265	1/8" Pipe	65°

Sec. 15

O-RING ASSORTMENTS

Photos not actual size



18885

Air Conditioning Nitrile O-Rings
For use with R134A & R12 refrigerant
 18 Varieties - 203 Pieces

Auveco Part No.	Inner Diameter	Outer Diameter	Thickness
17604	.290"	.432"	.071"
18646	3/8"	1/2"	1/16"
17605	.400"	.546"	.073"
17606	.509"	.655"	.073"
17607	.617"	.769"	.076"
18647	11/16"	13/16"	1/16"
18134	4.5mm	7.3mm	1.4mm
18135	6mm	9.6mm	1.8mm
18136	6.5mm	9.5mm	1.5mm
18137	6.6mm	10.2mm	1.8mm
18138	7.7mm	11.3mm	1.8mm
18140	10.7mm	15.5mm	2.4mm
18139	10.8mm	14.4mm	1.8mm
18141	13.3mm	18.1mm	2.4mm
18143	13.4mm	17.2mm	1.9mm
18142	14mm	17.6mm	1.8mm
18144	14.8mm	19.6mm	2.4mm
19235	13/16"	1-1/16"	1/8"



21845

Air Conditioning O-Rings
 Blue Neoprene (Teflon Coated)
For use with R134A & R12 Refrigerant
 6 Varieties - 325 Pieces

Auveco Part No.	Industry Standard	Inner Diameter	Outer Diameter	Thickness
18533	108	1/4"	7/16"	3/32"
18534	011	5/16"	7/16"	1/16"
18536	110	3/8"	9/16"	3/32"
18537	013	7/16"	9/16"	1/16"
18539	112	1/2"	11/16"	3/32"
18543	017	11/16"	13/16"	1/16"

BUNA-N RUBBER O-RINGS

Sec. 16

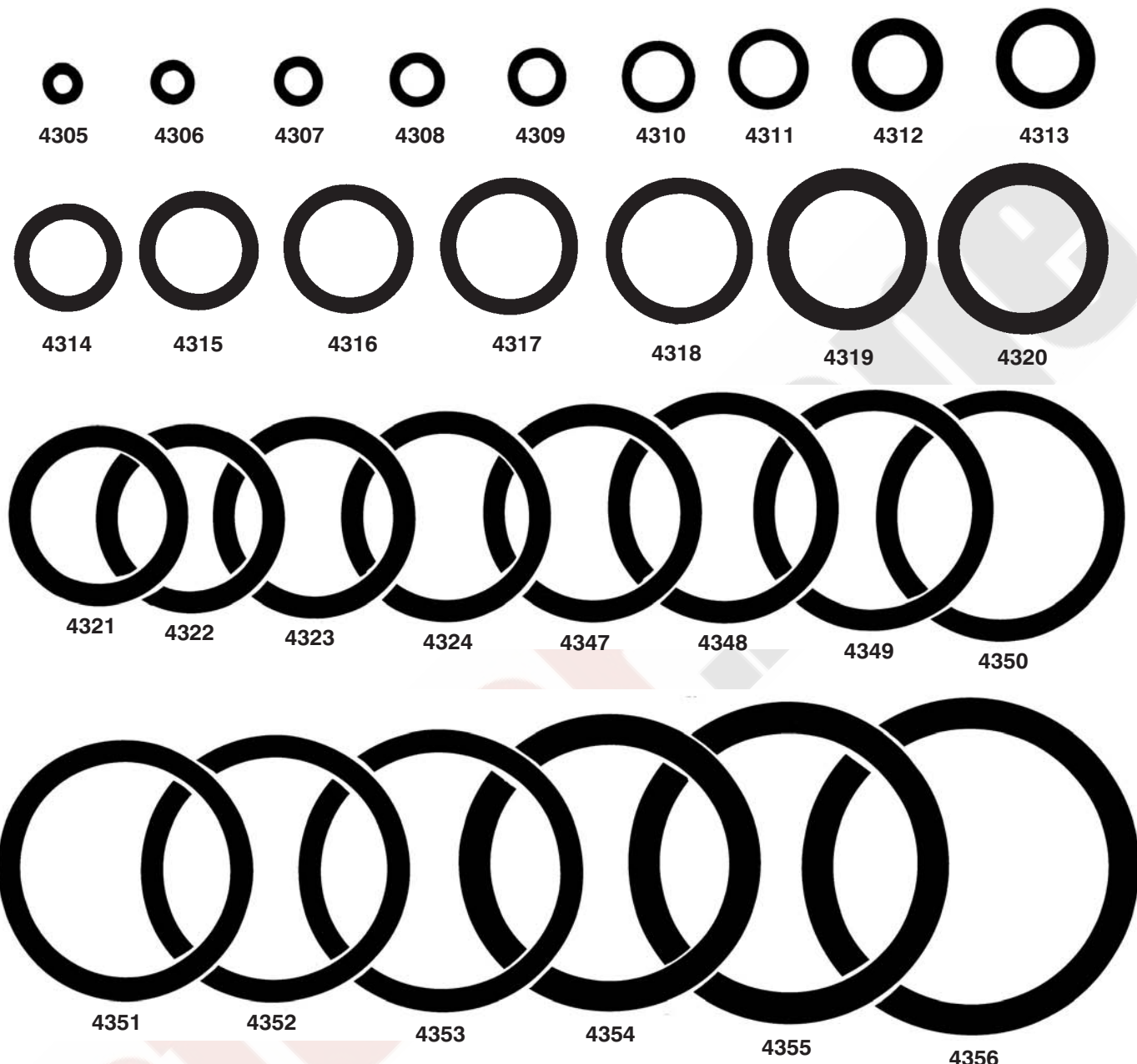

Auveco Part No.	Thickness
4305 thru 4311	1/16"
4312 thru 4318	3/32"
4319 thru 4353	1/8"
4354 thru 4356	13/64"

Temperature Rating: 70 hours at 100°C

Auveco Part No.	Ind. Std.	I.D.	O.D.	Unit Pkg.
4305	006	1/8"	1/4"	50
4306	007	5/32"	9/32"	50
4307	008	3/16"	5/16"	50
4308	009	7/32"	11/32"	50
4309	010	1/4"	3/8"	50
4310	011	5/16"	7/16"	50
4311	012	3/8"	1/2"	50
4312	110	3/8"	9/16"	50
4313	111	7/16"	5/8"	50
4314	112	1/2"	11/16"	50
4315	113	9/16"	3/4"	50

Auveco Part No.	Ind. Std.	I.D.	O.D.	Unit Pkg.
4316	114	5/8"	13/16"	50
4317	115	11/16"	7/8"	50
4318	116	3/4"	15/16"	50
4319	210	3/4"	1"	50
4320	211	13/16"	1-1/16"	50
4321	212	7/8"	1-1/8"	50
4322	213	15/16"	1-3/16"	50
4323	214	1"	1-1/4"	50
4324	215	1-1/16"	1-5/16"	50
4347	216	1-1/8"	1-3/8"	25
4348	217	1-3/16"	1-7/16"	25
4349	218	1-1/4"	1-1/2"	25
4350	219	1-5/16"	1-9/16"	25
4351	220	1-3/8"	1-5/8"	25
4352	221	1-7/16"	1-11/16"	25
4353	222	1-1/2"	1-3/4"	25
4354	325	1-1/2"	1-7/8"	25
4355	326	1-5/8"	2"	25
4356	327	1-3/4"	2-1/8"	25

Sec. 16

METRIC BUNA-N RUBBER O-RINGS

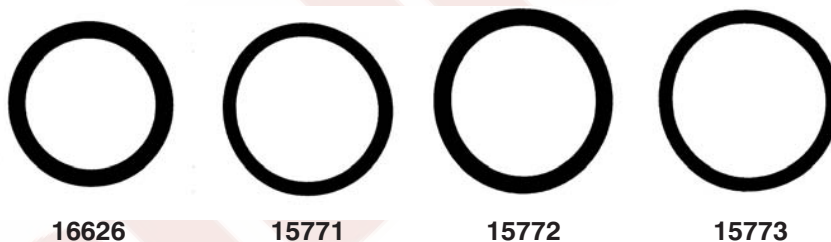
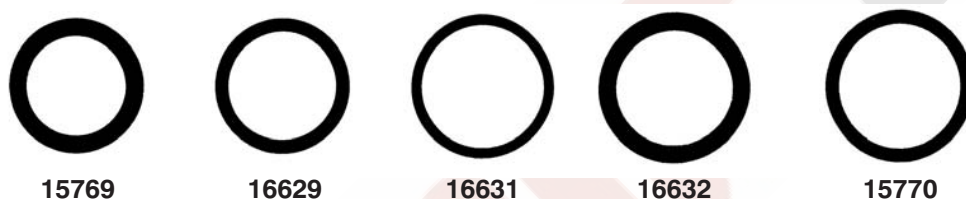
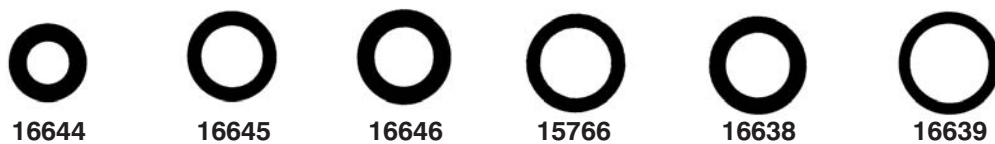
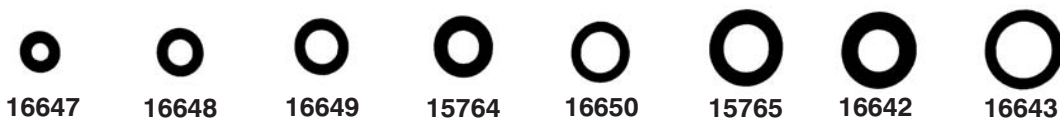

Auveco Part No.	Inner Diameter	Outer Diameter	Thickness	Unit Pkg.
16647	2.2mm	5.4mm	1.6mm	50
16648	3.1mm	6.3mm	1.6mm	50
16649	4.1mm	7.3mm	1.6mm	50
15764	4mm	8mm	2mm	100
16650	5mm	8mm	1.5mm	50
15765	6mm	10mm	2mm	100
16642	5.3mm	10.1mm	2.4mm	50
16643	7.1mm	10.3mm	1.6mm	50
16644	5.6mm	10.4mm	2.4mm	50
16645	8mm	12mm	2mm	50
16646	7.6mm	12.4mm	2.4mm	50
15766	9mm	13mm	2mm	100
16638	8.3mm	13.1mm	2.4mm	50
16639	10.1mm	13.3mm	1.6mm	50
16640	8.6mm	13.4mm	2.4mm	50

Auveco Part No.	Inner Diameter	Outer Diameter	Thickness	Unit Pkg.
15767	10mm	15mm	2.5mm	100
16634	10mm	16mm	3mm	50
15768	12mm	16mm	2mm	100
16635	13mm	16mm	1.5mm	50
16636	11mm	17mm	3mm	50
15769	13mm	18mm	2.5mm	100
16629	14mm	18mm	2mm	50
16631	16mm	19mm	1.5mm	50
16632	15mm	20mm	2.5mm	50
15770	16mm	20mm	2mm	50
16626	17mm	22mm	2.5mm	25
15771	19mm	23mm	2mm	50
15772	19mm	24mm	2.5mm	50
15773	20mm	24mm	2mm	50

O-RINGS

Air Conditioning O-Rings

For use with R12 Refrigerant only

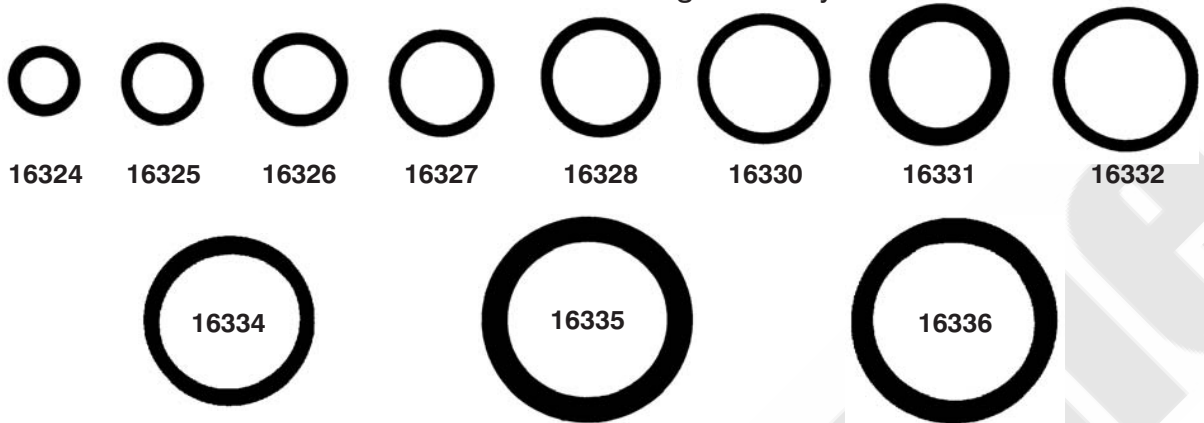

For original air conditioning systems. Not for use with R134A refrigerant.

Auveco Part No.	Ind. Std.	I.D.	O.D.	Thick-ness	Unit Pkg.	Auveco Part No.	Ind. Std.	I.D.	O.D.	Thick-ness	Unit Pkg.
16324	010	1/4"	3/8"	1/16"	50	16331	113	9/16"	3/4"	3/32"	25
16325	011	5/16"	7/16"	1/16"	50	16332	016	5/8"	3/4"	1/16"	50
16326	012	3/8"	1/2"	1/16"	50	16334	018	3/4"	7/8"	1/16"	25
16327	013	7/16"	9/16"	1/16"	50	16335	211	13/16"	1-1/16"	1/8"	10
16328	014	1/2"	5/8"	1/16"	50	16336	118	7/8"	1-1/16"	3/32"	25
16330	015	9/16"	11/16"	1/16"	50						

Nitrile Air Conditioning O-Rings

For use with R12 & R134A Refrigerant

These O-Rings are either green or black with an orange dot.

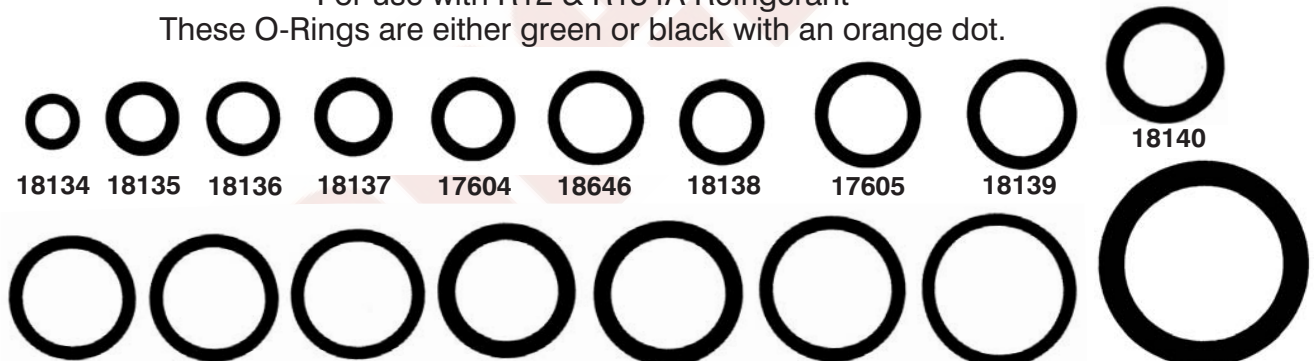

Auveco Part No.	I.D.	O.D.	Thickness	OEM No.	Unit Pkg.
18134	4.5mm	7.3mm	1.4mm	Nissan: 92472-N8200	25
18135	6mm	9.6mm	1.8mm	Nissan: 92470-N8200	25
18136	6.5mm	9.5mm	1.5mm	Toyota: 90099-14044	25
18137	6.6mm	10.2mm	1.8mm	Acura: 80873-ST7-000	25
17604	.290"	.432"	.071"	Ford: 391396	25
18138	7.7mm	11.3mm	1.8mm	Nissan: 92474-N8200	25
18646	.375"	.500"	.063"		25
17605	.400"	.546"	.073"	Ford: 391397	25
18139	10.8mm	14.4mm	1.8mm	Nissan: 92471-N8200	25
18140	10.7mm	15.5mm	2.4mm	Acura: 80872-ST7-000	25
				Nissan: 92475-W1000	
17606	.509"	.655"	.073"	Ford: 391304	25
18143	13.4mm	17.2mm	1.9mm	Toyota: 90099-14045	15
18142	14mm	17.6mm	1.8mm	Nissan: 92473-N8200	25
18141	13.3mm	18.1mm	2.4mm	Acura: 80871-ST7-000	25
18144	14.8mm	19.6mm	2.4mm	Nissan: 92475-W2100	15
17607	.617"	.769"	.076"	Ford: 391305	15
18647	.688"	.813"	.063"		25
19235	13/16"	1-1/16"	1/8"		10

Sec. 16

O-RINGS & GROMMETS

Blue Neoprene Air Conditioning O-Rings

Teflon Coated • For use with R134A & R12 Refrigerant

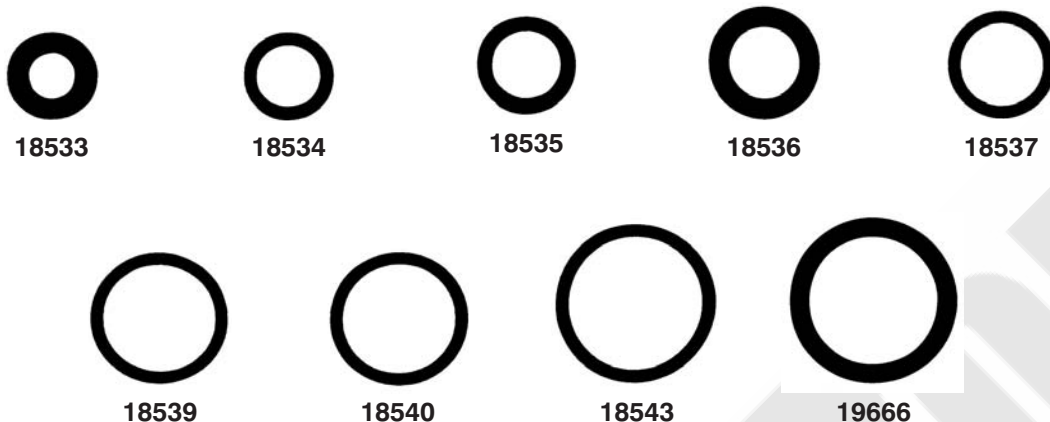

Auveco Part No.	Industry Standard	Inner Diameter	Outer Diameter	Thickness	Unit Pkg.
18533	108	1/4"	7/16"	3/32"	25
18534	011	5/16"	7/16"	1/16"	25
18536	110	3/8"	9/16"	3/32"	25
18537	013	7/16"	9/16"	1/16"	25
18539	112	1/2"	11/16"	3/32"	25
18540	015	9/16"	11/16"	1/16"	25
18543	017	11/16"	13/16"	1/16"	25
19666	115	11/16"	7/8"	3/32"	25

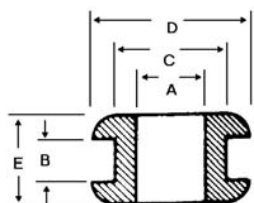

Rubber Grommet

Made of SBR Material • Durometer Hardness 60



UNIT PACKAGE: 25

Auveco Part No.	A Bore Dia.	B Groove Width	C Groove Dia.	D Outside Dia.	E Overall Thick-ness
4408	1/8"	3/32"	3/8"	1/2"	5/16"
4410	5/32"	1/16"	1/4"	3/8"	3/16"
4411	5/32"	3/32"	1/4"	7/16"	3/8"
4413	3/16"	1/16"	5/16"	1/2"	1/4"
4414	3/16"	3/32"	9/32"	3/8"	5/16"
4415	3/16"	1/4"	5/16"	7/16"	3/8"
16454	1/4"	1/16"	3/8"	1/2"	3/16"
4417	1/4"	1/16"	7/16"	5/8"	3/16"
4418	1/4"	1/16"	1"	1-1/4"	1/4"
4419	5/16"	1/16"	7/16"	9/16"	3/16"
4420	5/16"	1/16"	9/16"	13/16"	5/16"
16455	5/16"	1/16"	3/4"	1"	5/16"
4421	5/16"	1/8"	9/16"	13/16"	3/8"
4422	5/16"	1/4"	9/16"	13/16"	1/2"
4423	3/8"	1/16"	1/2"	11/16"	9/32"

Auveco Part No.	A Bore Dia.	B Groove Width	C Groove Dia.	D Outside Dia.	E Overall Thick-ness
16456	3/8"	1/16"	5/8"	7/8"	11/32"
4425	3/8"	1/16"	1"	1-1/4"	1/4"
4426	3/8"	1/4"	5/8"	7/8"	1/2"
16457	7/16"	1/16"	9/16"	3/4"	1/4"
4428	1/2"	3/32"	3/4"	31/32"	9/32"
4429	1/2"	3/32"	25/32"	1"	11/32"
16458	1/2"	1/8"	3/4"	1"	1/2"
4430	1/2"	1/4"	13/16"	1-1/16"	1/2"
4431	5/8"	1/8"	7/8"	1-1/8"	3/8"
4432	5/8"	1/16"	7/8"	1-1/8"	5/16"
4433	3/4"	1/16"	15/16"	1-1/8"	1/4"
4434	3/4"	1/16"	1-1/16"	1-3/8"	3/8"
4435	3/4"	1/16"	1-1/4"	1-5/8"	1/4"
4436	3/4"	1/4"	1-1/4"	1-5/8"	7/16"

Vinyl Grommet

- Black Vinflex 163
- Exceptional Aging Qualities
- High Dielectric Properties
- Oil Resistant
- Non-Conductive
- Durometer Hardness 60
- Excellent Resistance to
- Ozone and Sunlight

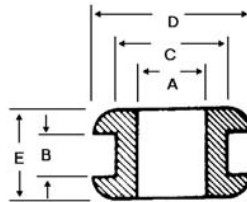

14765

- “A” Bore Diameter: 5/16”
- “B” Groove Width: 1/16”
- “C” Groove Diameter: 7/16”
- “D” Outside Diameter: 5/8”
- “E” Overall Thickness: 1/4”

UNIT PACKAGE: 50

Tubeless Tire Valves



Length: 1-1/4”
 Rim Hole: 29/64”
 (TR413)

10184

UNIT PACKAGE: 5

10191

UNIT PACKAGE: 25

10192

UNIT PACKAGE: 100

PICKUP TRUCK CAP WEATHERSTRIP TAPE

Photo not actual size



Closed-cell foam weatherstrip tape. Used on the bottom lip of the cap or the truck’s flange to form a moisture, dust and vibration resistant seal. Features an aggressive acrylic adhesive.

Exact Size Profile



20922

Light Gray

1-1/4” Width x 30 Ft. Length
 Thickness: 3/16”

UNIT PACKAGE: 1 Roll

Sec. 16

SPONGE WEATHERSTRIPS

Peel-Bak Adhesive Neoprene Sponge Weatherstrip

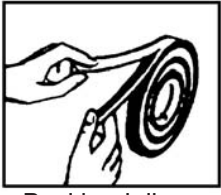

Peel back liner.



Press on clean dry surface

Peel-Bak is a light-weight closed cell sponge material. It is an easy to apply weatherstrip for auto and household use.

Can also be used on boats, refrigerators or any place a weatherproof, permanent seal is required.

Simple to use: Peel back the liner tape and press into place. No cement or tacking required. Surface must be clean and dry.



Photo not actual size

Thickness	Width	10 Ft. Roll Auveco Part No.	50 Ft. Roll Auveco Part No.
5/32"	3/8"	4800	4850
5/32"	1/2"	4801	4851
5/32"	5/8"	4802	4852
5/32"	3/4"	4803	4852
5/32"	1"	4804	4853
5/16"	3/8"	4805	4854
5/16"	1/2"	4806	4855
5/16"	5/8"	4807	4856
5/16"	3/4"	4808	4856
5/16"	1"	4809	4857
7/16"	3/8"	4810	4858
7/16"	1/2"	4811	4859
7/16"	3/4"	4812	4860
7/16"	1"	4813	4861

Exact Size Profile

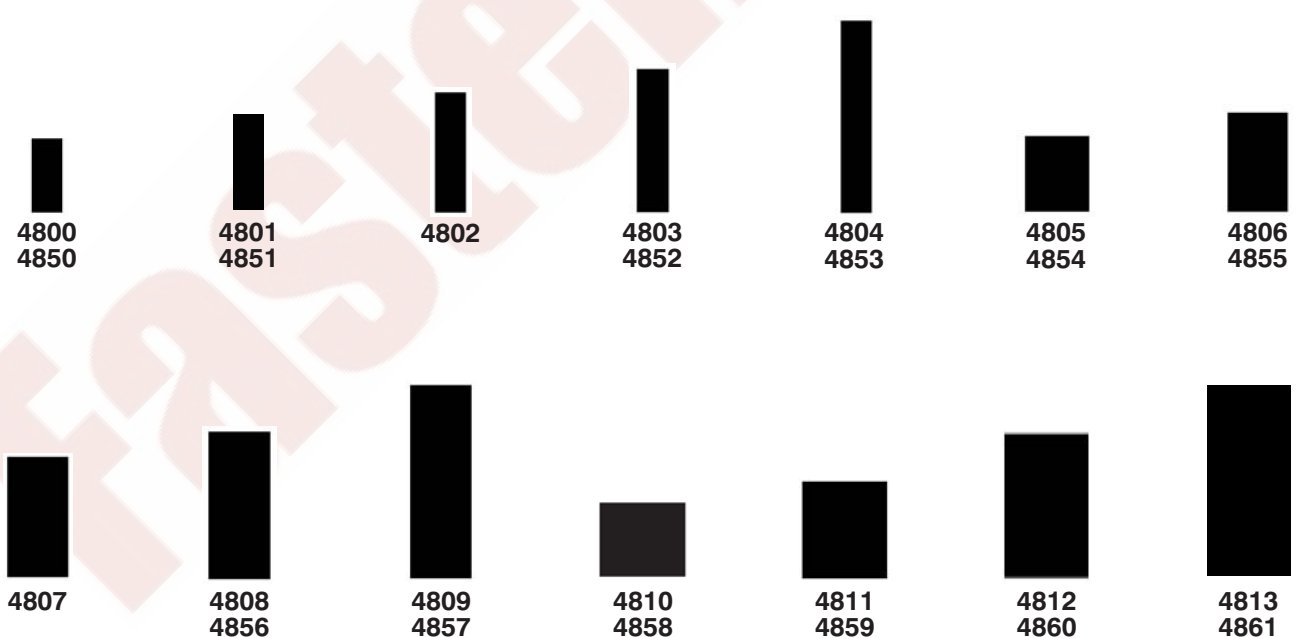

WEATHERSTRIPS

PVC Foam Adhesive Weatherstrips

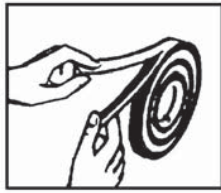

Peel back liner.



Press on clean dry surface

Low density, PVC (polyvinyl chloride) foam weatherstrip with a permanent acrylic adhesive for easy application even on irregular or curved surfaces. Seals out air, moisture, dust and light. It is also cushioning against vibration and noise. Remains flexible at -20° C to 80° C (-4° F to 176° F).

Color: Light Gray

Photo not actual size



Thickness	Width	10 Ft. Roll Auveco Part No.	50 Ft. Roll Auveco Part No.
3/16"	1/2"	20912	
5/16"	3/4"	20914	20915
5/16"	1"	20916	20917
7/16"	3/4"	20918	20919
7/16"	1"	20920	

Exact Size Profile



Sponge Rubber Weatherstrips

EPDM Closed Cell • Light Weight • Weather Resistant



16390
Door Flange Weatherstrip
GM, Ford & Chrysler Cars & Trucks

UNIT PACKAGE: 15 Ft.



16395
Trunk & Rear Deck Gutter Weatherstrip
GM

UNIT PACKAGE: 15 Ft.



4675
Same as 16390 except for unit package quantity
UNIT PACKAGE: 50 Ft.

4703
Same as 16395 except for unit package quantity
UNIT PACKAGE: 50 Ft.



4707
Door Flange Weatherstrip
Chrysler 1954-50
Ford 1958-50

UNIT PACKAGE: 50 Ft.



4731
Door Flange Weatherstrip
GM 1954-53
Universal

UNIT PACKAGE: 50 Ft.

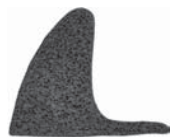

4747
Door Inner Belt Weatherstrip
All Cars 1970-55

UNIT PACKAGE: 50 Ft.

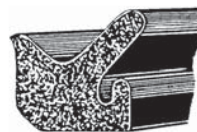

16392
Door Flange Weatherstrip
Ford 1955-On

UNIT PACKAGE: 15 Ft.



4745
Same as 16392 except for unit package quantity
UNIT PACKAGE: 50 Ft.

Sec. 16

SPONGE RUBBER WEATHERSTRIPS

EPDM Closed Cell • Light Weight • Weather Resistant



4742

Trunk & Lid
Weatherstrip
GM 1959 - On
Ford 1949 - On
Studebaker 1967 - 55



UNIT PACKAGE: 50 Ft.



16394

Deck Lid
Weatherstrip
GM 1956 - On



UNIT PACKAGE: 15 Ft.

4749

Same as 16394 except for unit package quantity.

UNIT PACKAGE: 50 Ft.



16391

Door Flange Weatherstrip
GM: 1955 - On



UNIT PACKAGE: 15 Ft.

4744

Same as 16391 except for unit package quantity.

UNIT PACKAGE: 50 Ft.

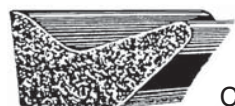

16393

Door Flange
Weatherstrip
Chrysler 1958 - On



UNIT PACKAGE: 15 Ft.

4746

Same as 16393 except for unit package quantity.

UNIT PACKAGE: 50 Ft.



16890

Door Flange
Weatherstrip
Ford 1956 - 53



UNIT PACKAGE: 25 Ft.

16891

Same as 16890 except for unit package quantity.

UNIT PACKAGE: 50 Ft.

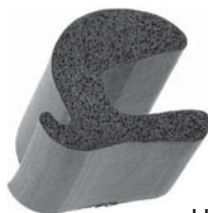

4743

Trunk
Weatherstrip
Universal



UNIT PACKAGE: 35 Ft.



16892

Roof Rail Weatherstrip
GM 1977 - 68



UNIT PACKAGE: 25 Ft.



4750

(C5AZ-6243720-B)

Deck Lid
Weatherstrip
Ford 1956 - On



UNIT PACKAGE: 50 Ft.



20928

Door Flange,
Trunk & Tail Gate
Weatherstrip
Hole Diameter: 3/32"
Universal



UNIT PACKAGE: 25 Ft.



16525

Door Seal Weatherstrip
GM 1963 - 55



UNIT PACKAGE: 50 Ft.

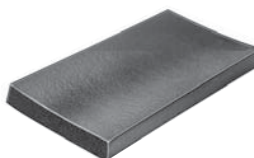

**Extruded Closed Cell
Sponge Rubber**

Will not absorb water or moisture.
Without Cement.

19341

Exact Size Profile

1/8" Thick -3/4" Wide

UNIT PACKAGE: 25 Ft.

4740

Exact Size Profile

1/8" Thick -1-1/2" Wide

UNIT PACKAGE: 25 Ft.

SPONGE RUBBER WEATHERSTRIPS

EPDM Closed Cell • Light Weight • Weather Resistant

Sec. 16

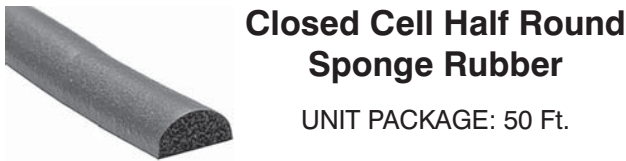

Closed Cell Half Round Sponge Rubber

UNIT PACKAGE: 50 Ft.



4736
1/4" Half Round



4737
3/8" Half Round



4738
1/2" Half Round



Closed Cell Sponge Rubber Windlace Cord

Flexible filler for cloth covered windlace on door, windshield pillars and door bottoms.

UNIT PACKAGE: 50 Ft.



4654
1/4" Diameter



4655
3/8" Diameter



4656
1/2" Diameter

RUBBER BUMPERS & GROMMETS



4280

(3745361, 3762180)

License Plate Bumper
GM

UNIT PACKAGE: 25



4265

(3711168)

Door Lock Striker Plate, Window Glass
Stop & License Plate Bumper
GM

UNIT PACKAGE: 25



4260

(17562)

Windshield Wiper Rubber Grommet
Inner Diameter: 11/32"
Outer Diameter: 5/8"
Thickness: 3/16"
Ford

UNIT PACKAGE: 25



4188

(4081765)

Door & Quarter Glass and
Door Opening Header Bumper
GM

UNIT PACKAGE: 25



4246

(357811)

Gas Tank Lid Rubber Bumper
Ford

UNIT PACKAGE: 25



4237

(3664645)

General Purpose
GM

UNIT PACKAGE: 25



4242

(4137121)

Trunk, Rear Deck Lid, &
Hood Bumper
GM

UNIT PACKAGE: 25



4235

(3688811)

Hood Top Panel Side
Bumper to Fender
GM

UNIT PACKAGE: 25



4243

(513388)

Hood to Ledge Bumper
GM

UNIT PACKAGE: 25



4248

(16758)

General Purpose
Ford

UNIT PACKAGE: 25

Sec. 16

RUBBER BUMPERS & GROMMETS



4258
(352839)

General Purpose
Ford

UNIT PACKAGE: 25



4233
(3655015)

General Purpose
GM

UNIT PACKAGE: 25



4447
(7724826)

Trunk Lid Bumper
GM

UNIT PACKAGE: 10



4273
(B7A-16758-A)

Hood Bumper
Ford

UNIT PACKAGE: 25



13967

General Purpose
Outer Diameter: 1/2"
Head Height: 5/16"
Fits into 1/4" Hole
Durometer: 55-65

UNIT PACKAGE: 25



4369
(3900684, 15029828)

Pillar Bumper
GM Trucks

UNIT PACKAGE: 25



4446
(4872948)

Trunk Lid Bumper
GM

UNIT PACKAGE: 25



4249
(1304225)

General Purpose
GM

UNIT PACKAGE: 25



4264
(4564974)

Front Door Bumper
GM

UNIT PACKAGE: 25



4250
(3693292)

Glove Box Door Bumper
GM

UNIT PACKAGE: 25



4441
(4565591, 7637192)

Front Door Bumper
GM

UNIT PACKAGE: 25



4155
(16758A)

General Purpose
Ford

UNIT PACKAGE: 25



4357
(C60Z-16758-A)

Hood to Fender Bumper
Ford

UNIT PACKAGE: 25



4244
(972724)

General Purpose
Chrysler

UNIT PACKAGE: 25

RUBBER BUMPERS & GROMMETS

Sec. 16



4204
(4023030)

General Purpose
Ford & Chrysler

UNIT PACKAGE: 25



4240
(4563173, 4565415)

Door Bumper
GM

UNIT PACKAGE: 25



4236
(3689084)

General Purpose
GM

UNIT PACKAGE: 25



4281
(4721222)

Trunk Lid Bumper
GM

UNIT PACKAGE: 25



20698

Black Rubber

Cigarette Lighter Safety Plug
Used to replace unwanted
cigarette lighters. Prevents
accidental shocks and burns.
Discourages smoking in the car.
The tight fit deters removal.

UNIT PACKAGE: 2



15453
(472450, 12338034)

Hood Bumper
Across the Flats: 1"
Diameter: 15/16"
Overall Length: 1-29/32"
GM X Cars 1980 - On

UNIT PACKAGE: 10



4474
(400764, 400765)

5/16-18 x 2-1/8"
Hood Adjusting Bolt & Bumper
GM

UNIT PACKAGE: 5

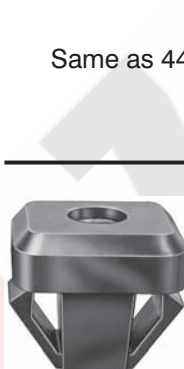

4473

Same as 4474 except for unit package quantity

UNIT PACKAGE: 10

16849
(Not Supplied by O.E.M.)
Nylon

Hood Adjustment Nut
Threaded Insert: M6-1.0
Ford 1989 - On

UNIT PACKAGE: 10

16850
(Not Supplied by O.E.M.)
Zinc

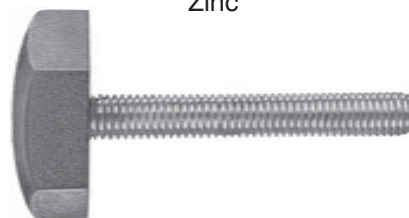

M6-1.0 x 44mm
Hood Adjustment Bumper
Hex: 23mm
Ford 1989 - On

UNIT PACKAGE: 5

16832
(E83Z-16758-A)

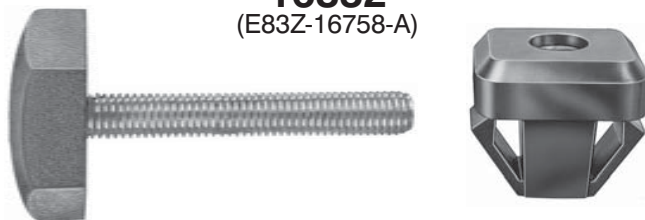

Hood Adjustment Nut & Bumper
Ford 1989 - On

UNIT PACKAGE: 2 Sets

Sec. 16 DOOR SEALS, WINDOW SEALS & CHANNELS



Door Seals

Years	Vehicle	Application	O.E.M. Number	Auveco Part No.
1991-73	Blazer, Jimmy & Suburban	Driver & Passenger Rear Side	15606409, 15227654, 15227655	20792
1987-73	Pickup	Driver & Passenger Side	15606409, 15227654, 15227655	20792



Window Channels



Years	Vehicle	Application	O.E.M. Number	Auveco Part No.
1991-73	Blazer, Jimmy & Suburban	Complete Glass Run with metal clip Front – Driver Side	14027777	20793
1991-73	Blazer, Jimmy & Suburban	Complete Glass Run with metal clip Front-Passenger Side	14027778	20794
1987-73	Pickup	Complete Glass Run with metal clip Front-Driver Side	14027777	20793
1987-73	Pickup	Complete Glass Run with metal clip Front-Passenger Side	14027778	20794

Belt Weatherstrips



Years	Vehicle	Application	O.E.M. Number	Auveco Part No.
1991-81	Blazer, Jimmy & Suburban	Inner-Driver Side	15569071	20797
1991-81	Blazer, Jimmy & Suburban	Inner-Passenger Side	15569072	20798
1991-73	Blazer, Jimmy & Suburban	Outer-Driver Side	14027775	20799
1991-73	Blazer, Jimmy & Suburban	Outer-Passenger Side	14027776	20800
1987-81	Pickup	Inner-Driver Side	15569071	20797
1987-81	Pickup	Inner-Passenger Side	15569072	20798
1987-73	Pickup	Outer-Driver Side	14027775	20799
1987-73	Pickup	Outer-Passenger Side	14027776	20800
1980-73	Pickup, Jimmy, Blazer & Suburban	Inner-Driver Side	470433	20795
1980-73	Pickup, Jimmy, Blazer & Suburban	Inner-Passenger Side	470434	20796



Vent Window Seals

Years	Vehicle	Application	O.E.M. Number	Auveco Part No.
1980-73	Pickup, Jimmy, Blazer & Suburban	Front Driver Side (Vertical sold separately)	6271903	20801
1980-73	Pickup, Jimmy, Blazer & Suburban	Front Passenger Side (Vertical sold separately)	6271904	20803
1980-73	Pickup, Jimmy, Blazer & Suburban	Rear Vertical-Driver Side	6271905	20802
1980-73	Pickup, Jimmy, Blazer & Suburban	Rear Vertical-Pass. Side	6271906	20804

GLASS SETTING CHANNELS

EPDM Dense Rubber

Sec. 16



4511

For 1/8" Glass
Glass Setting Channel
Height: 11/32"
Width at Base: 1/4"
Inside Base: 1/8"

UNIT PACKAGE: 50 Ft.



4513

For 1/4" Glass
Windshield and Rear Window
Glass Setting Channel
Height: 7/16"
Width at Base: 31/64"
Inside Base: 1/4"

UNIT PACKAGE: 50 Ft.



4512

For 3/16" Glass
Windshield and Rear Window
Glass Setting Channel
Height: 7/16"
Width at Base: 27/64"
Inside Base: 3/16"

UNIT PACKAGE: 50 Ft.



4688

For 1/4" Glass
Rear Window Glass
Setting Channel
Chrysler Early Models

UNIT PACKAGE: 50 Ft.



4670

For 1/4" Glass
Windshield &
Rear Window Glass Setting
Channel and Weatherstrip
Ford, Mercury Early Models

UNIT PACKAGE: 50 Ft.



4588

For 1/4" Glass
Windshield and Rear Window
Glass Setting Channel
Height: 9/16"
Width at Base: 7/16"
Inside Base: 1/4"

UNIT PACKAGE: 50 Ft.



4515

For 1/4" Glass
Glass Setting Channel
Height: 9/16"
Width at Base: 25/64"
Inside Base: 1/4"

UNIT PACKAGE: 50 Ft.



4671

For 1/4" Glass
Rear Window Glass
Setting Channel and
Weatherstrip
Chrysler Early Models

UNIT PACKAGE: 50 Ft.

Molded Dense Rubber Tee Rubber Concave Head

UNIT PACKAGE: 50 Ft.



4530

Head: 9/32"
Height: 3/4"

4531

Head: 9/32"
Height: 1"



4581

For 1/4" glass
Windshield Glass Weatherstrip

UNIT PACKAGE: 50 Ft.

Universal Windshield & Rear Window Flex-Fit Rubber Moulding



Photo not actual size

20342

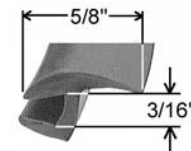

A universal windshield rubber moulding for domestic and import vehicles. Made of EPDM rubber, this moulding contains a butyl bead that adheres to the glass during installation. The profile design allows for the moulding to attach easily to the glass edge and lay evenly on the vehicle body along straight areas and around corners. Extruded with a metal filament to prevent stretching and shrinkage.

UNIT PACKAGE: 15 Feet

Sec. 16

EPDM RUBBER WEATHERSTRIP FOR GLASS

Photos not actual size



17509

Glass Thickness: 1/4"
Body Thickness: 1/16"
Self-Locking Type

UNIT PACKAGE: 50 Ft.



17513

Glass Thickness: 1/4"
Body Thickness: 1/8"
Bead Lock Type
Use with
Auveco 17514

UNIT PACKAGE: 50 Ft.



17510

Glass Thickness: 1/4"
Body Thickness: 1/8"
Self-Locking Type

UNIT PACKAGE: 50 Ft.



17514

Glass Thickness 1/4"
Locking Bead
Use with Auveco 17513

UNIT PACKAGE: 50 Ft.

Caps & Hooks

Rubber Caps

Special Heat Resistant EPDM Rubber
Can be used for capping lines and hoses while testing carburetors, emission control systems, vacuum lines, etc

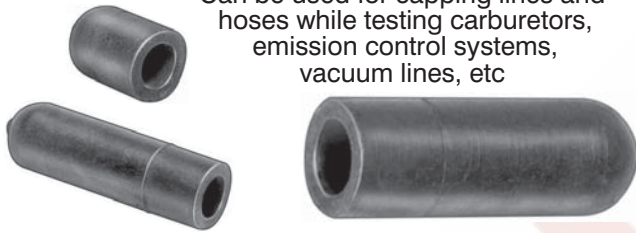

Auveco Part No.	Fits Tube O.D.	Inside Length	Unit Pkg.
12209	1/8"	9/16"	25
4440	3/16"	9/16"	25
16264	3/16"	9/16"	100
19000	3/16"	1-1/4"	25
4439	1/4"	9/16"	25
19001	1/4"	1-1/4"	25
19002	5/16"	9/16"	25
12907	5/16"	1-1/4"	25
12210	3/8"	31/32"	25
19003	3/8"	1-1/2"	25
12908	1/2"	11/16"	10

Vinyl Vacuum Caps

Can be used for capping lines and hoses while testing carburetors, emission control systems, vacuum lines, etc. Color coded for size identification.



Auveco Part No.	I.D.	Fits Tube O.D.	Color	Length	Unit Pkg.
18202	1/8"	3/16"	Blue	5/8"	50
18203	3/16"	1/4"	Red	5/8"	50
18204	1/4"	5/16"	White	5/8"	50
18205	5/16"	3/8"	Black	5/8"	50

Rubber Hold Down Straps with Hooks

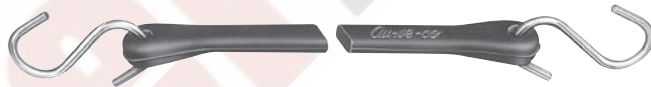

Auveco Part No.	Length	Span Range	Unit Pkg.
4448	9"	15" to 20"	10
4449	15"	20" to 30"	10
4450	20"	30" to 40"	10
4451	31"	40" to 55"	10



11298

Galvanized

3/16" x 3"
"S" Hook

Used with Auveco Rubber Hold Down Straps 4448, 4449, 4450 and 4451

UNIT PACKAGE: 50

11299

Same as 11298 except for unit package quantity

UNIT PACKAGE: 100

GLASS SHOP SUPPLIES

Sec. 17



18979
(3767196)

Windshield Setting Block
Lower Spacer
Chrysler Caravan,
Voyager and Town & Country
1984 - On

UNIT PACKAGE: 15



19817
Black Nylon

Universal Glass Setting Block
Width: 1-3/16"
Height: 7/16"
Length: 15/16"

UNIT PACKAGE: 25

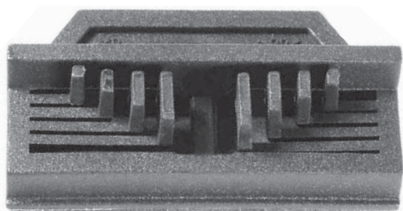

21195
(15061964)
Black Nylon

Windshield Glass
Setting Block with
Adhesive Backing

Overall Length: 51mm
Buick Rainier; Cadillac Escalade; Chevrolet
Avalanche, Colorado, Silverado, Suburban, Tahoe
& Trailblazer; GMC Canyon, Envoy, Sierra & Yukon;
Hummer H2 & H3 Oldsmobile Bravada and Saab 9-7
1999 - On

UNIT PACKAGE: 10



3135

Window Regulator
Roller Assembly
Ford

UNIT PACKAGE: 25



10843
(3696693)
Nylon

Front Door Glass Lift to Stabilizer Bushing
Chrysler

UNIT PACKAGE: 50



20836
(4L3Z-1503296-AB)
Black Nylon

Windshield Setting Block
Ford Pick-Up Trucks
2004 - On

UNIT PACKAGE: 5



21423
(BMW: 51321-938-884)
White Nylon

Window Regulator Guide
BMW 3 & 5 Series 1989 - On

UNIT PACKAGE: 2



19816
(55256967AC)
Black & Natural
Nylon

Windshield Glass
Adjustable Setting Block
NAGS Numbers:
DW0999 & DW1295
Dodge Dakota & Durango 1997 - On

UNIT PACKAGE: 10



2598
(353745-S)

Window Regulator Arm to Plate
Assembly Clip
Ford

UNIT PACKAGE: 100



20942
(F6DZ-5403296-A)
Black Nylon

Windshield Setting Block
Width: 1-5/32"
Length: 1-1/8"
Height: 13/16"
Fits into 9/32" Square Hole
Ford Sable & Taurus 1996 - On

UNIT PACKAGE: 10



1267
Lacquered

Inside Door Handle &
Quarter Regulator
Handle Escutcheon
Tension Spring

UNIT PACKAGE: 25



2288
Zinc

Door & Window Crank Handle
Retaining Clip
GM, Ford & Toyota

UNIT PACKAGE: 100

Sec. 17

GLASS SHOP SUPPLIES



9886

Door & Window Crank Handle Retaining Clip

UNIT PACKAGE: 100



11

Coppered Spring Steel

Door & Window Crank Handle Retaining Clip
GM

UNIT PACKAGE: 100



16340

(54229-0201P)

Window Crank Handle Retaining Clip
Nissan

UNIT PACKAGE: 100



11152

(GM: 9731301; AMC: 4005540)
White Nylon

Windshield to Panel (Lower) Side Moulding Clip
GM 1975 - On
AMC 1975 - On

UNIT PACKAGE: 100



15813

(4005714)
Nylon

Window Glass Retainer
AMC Eagle 1988 - On

UNIT PACKAGE: 25



9633

(7698976)

Windshield Upper & Lower Moulding Clip
GM 1967 - On

UNIT PACKAGE: 100



9749

(7730788)

Windshield, Skylight, Quarter & Rear Window Reveal Moulding Clip
GM 1968 - On

UNIT PACKAGE: 50



8583

(4533699)

Rear Window Reveal Moulding Clip
GM 1965 - On

UNIT PACKAGE: 100



9275

(7634583, 8734067)

Rear Window Reveal Moulding Clip
GM 1966 - On

UNIT PACKAGE: 50

10242

Same as 9275 except for unit package quantity

UNIT PACKAGE: 100



9639

(7693140)

Windshield, Skylight, Rear & Quarter Window Reveal Moulding Clip
GM 1966 - On

UNIT PACKAGE: 50



11066

(9624520)

Window Reveal Moulding Clip
GM 1973 - On

UNIT PACKAGE: 50



11067

(9606232, 9662950, 20603072)

Windshield & Rear Window Reveal Moulding Clip
GM 1973 - On

UNIT PACKAGE: 100



10243

(8717859)

Rear Window Reveal Moulding Clip
GM 1969 - On

UNIT PACKAGE: 100



10701

(9895598)

Windshield Reveal Moulding Clip
GM 1971 - On

UNIT PACKAGE: 50

GLASS SHOP SUPPLIES

Sec. 17



10630
(9808241)

Windshield & Rear Window Reveal
Moulding Clip
GM 1970 - On

UNIT PACKAGE: 50



10631
(9854717)

Windshield Reveal Moulding Clip
GM 1970 - On

UNIT PACKAGE: 50



11345
(1654047)
Nylon

Windshield & Rear Window Reveal
Moulding Clip
GM 1974 - On

UNIT PACKAGE: 100



12135
(20169887)
Nylon

Windshield Reveal Moulding Clip
GM 1979 - On

UNIT PACKAGE: 50



11152
(GM: 9731301; AMC: 4005540)
White Nylon

Windshield to Panel (Lower)
Side Moulding Clip
GM 1975 - On
AMC 1975 - On

UNIT PACKAGE: 100

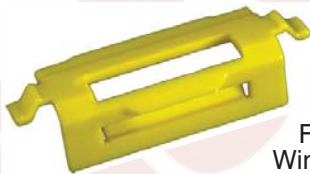

20232
(10287926)
Yellow Nylon

Front & Rear Door
Window Moulding Clip
Overall Length: 1-9/16"
Buick Century & Regal
and Oldsmobile Intrigue 1997 - On

UNIT PACKAGE: 25



17355
(GM: 94467458;
Isuzu: 8944674584)
Nylon

Windshield Reveal Moulding Clip
Geo Storm 1992 - On

UNIT PACKAGE: 10



20263
(22599312)
Black Nylon

Front & Rear Door
Window Moulding Clip
Chevrolet Malibu, Oldsmobile
Achieva & Cutlass 1997 - On

UNIT PACKAGE: 25



2628
(4657731)

Windshield & Rear Window
Reveal Moulding Fastener
GM

UNIT PACKAGE: 100



20276

(6003409, 6003752)

Windshield & Rear Window
Reveal Moulding Clip
Replaces Auveco 11177 & 13569
Chrysler 1974 - On

UNIT PACKAGE: 25



10622
(6002893)

Rear Window Reveal Moulding Clip
Chrysler 1971 - On

UNIT PACKAGE: 50



17151
(6004036)
Nylon

Window Reveal Moulding Clip
Chrysler LeBaron & Maserati
1987 - On

UNIT PACKAGE: 15



9882

(C8AZ-63642413-A,
D1AZ-6542413-B,
D1AB-6542413-AB)

Windshield & Rear Window
Reveal Moulding Clip
Ford 1968 - On

UNIT PACKAGE: 100



9353
(C6AB-6242413-A)

Rear Window
Reveal Moulding Clip
Ford 1967 - On

UNIT PACKAGE: 100

Sec. 17

GLASS SHOP SUPPLIES



8941
(C5ZZ-6543413-B)

Windshield & Rear Window
Reveal Moulding Clip
Ford 1966 - On

UNIT PACKAGE: 100



15462
(20478733,
22539533)
Nylon

Front Door Window
Guide Rear of Glass

Buick Skylark & Somerset 1991 - 85
Chevrolet Lumina APV 1990 - On
Olds Calais 1991 - 85
Olds Silhouette 1990 - On
Pontiac Grand Am 1991 - 85
Pontiac Trans Sport 1990 - On

UNIT PACKAGE: 15



13564
(E3SB-6342413-AB)

Windshield & Bakelite
Reveal Moulding Clip
Ford 1983 - On

UNIT PACKAGE: 50

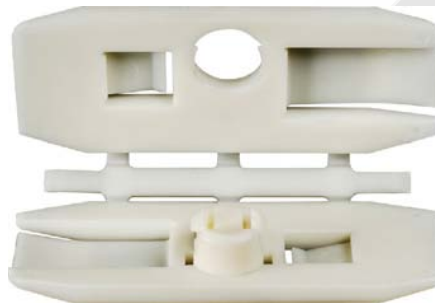

19397
(21098967)
Nylon

Front &
Rear Door
Window Guide
Saturn Sedan &
Wagon
1996 - On

UNIT PACKAGE: 5



21526
(Not Available from O.E.M.)
White Nylon

Windshield Moulding Clip
Head Size: 14.5mm x 30mm
Bottom Leg Width: 26mm
Ford Flex 2009 - On

UNIT PACKAGE: 25



15463
(12353912, 20487630, 20712176)
Nylon

Front Door Window Guide
Front of Glass (4mm Thick)
Buick Skylark & Somerset 1991-85
Chevrolet Lumina APV 1990-On; Olds Calais 1991-85;
Olds Silhouette 1990-On; Pontiac Grand Am 1991-85
Pontiac Trans Sport 1990-On

UNIT PACKAGE: 15



20424
(Not Available from O.E.M.)
White Nylon

Front Door Window Guide
Overall Length: 1-13/32"
Buick Electra, Park Ave. & Skylark; Chevrolet Malibu;
Oldsmobile Achieva, Alero, Cutlass & 98 Regency
and Pontiac Grand Am 1985 - On

UNIT PACKAGE: 5



21022
(4339372)
Black Nylon

Window Guide
with Rivets
Chrysler Acclaim,
GTS, Lancer, LeBaron,
Shadow, Spirit &
Sundance 1989 - On

UNIT PACKAGE: 25



15466
(20160591)
Nylon

Front Door
Window Guide
Upper Part of Glass
LeSabre 90-80 &
Electra 84-On; Fleetwood Brougham & DeVille 83-On;
Impala & Caprice 90-80 & Cavalier 87; Delta 88 &
Custom Cruiser 90-80 & 98 Regency 84-80;
Parisienne & Safari 89-81 & Sunbird 87

UNIT PACKAGE: 25

GLASS SHOP SUPPLIES

Sec. 17



15467

(10051034, 20123070, 20328600)
Nylon

Front & Rear Door Window Guide
Electra, Estate Wagon, LeSabre & Skylark; DeVille; Impala Wagon, Caprice & Citation; Delta 88, Custom Cruiser, 98 Regency & Omega; Catalina, Safari & Phoenix 81 - 80

UNIT PACKAGE: 25

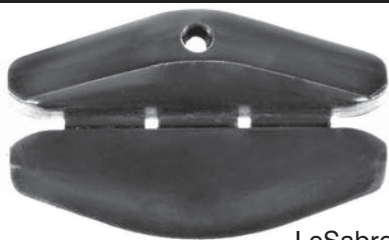

17159

(20747509)
Nylon

Front Door Window Guide Rear of Glass
Buick Electra & LeSabre Cadillac Fleetwood/DeVille Olds Delta & Regency Pontiac Bonneville 1985 - On

UNIT PACKAGE: 15

Photo not actual size



19819

(10274778)
Nylon

Front Side Door Window Guide
Chevrolet Venture APV, Oldsmobile Silhouette APV, Pontiac Montana & Trans Sport APV 1997 - On

UNIT PACKAGE: 10



17176

(20162174, 22543363)
Nylon

Front Door Window Guide
Buick Skyhawk, Cadillac Cimarron, Chevrolet Cavalier, Olds Firenza & Pontiac Sunbird 1982-On

UNIT PACKAGE: 25



Photo not actual size

17341

(12337898, 20747508)
Nylon

Front Door Window Guide Front of Glass
Buick Electra, LeSabre & Park Ave., Cadillac Fleetwood & DeVille, Olds 88 Royal & 98 Regency, Pontiac Bonneville 1985-On

UNIT PACKAGE: 15



17455

(20493450)
Nylon

Rear Door Window Guide Upper Glass
Chevrolet Corsica 1987 - On

UNIT PACKAGE: 15



18113

(69951-12180)

Nylon with Steel Treaded Insert

Glass Mount
Thread: M6-1.0
Nissan, Ford & Imports

UNIT PACKAGE: 5



19393

(F1TZ-17698A)

Rear View Mirror Bracket (Windshield Mounted)
NAGS numbers DW 1256, 1099 1169 & 1170

Fits Ford Mirrors F0TZ-17700-A & F7AZ-17700-A on Ford & L-M Continental, Contour, Escort, Mustang, Mystique, Sable, Taurus & Tracer 1991 - On

UNIT PACKAGE: 10



19394

(20626174)

Rear View Mirror Bracket (Windshield Mounted)
NAGS numbers 1168, 1191, 1192, 1193, 1194, 1195, 1265, 1288 & 1299
GM 1987-On

UNIT PACKAGE: 10



19498

Black Nylon

Rear View Mirror Adapter Bracket

This adapter bracket allows you to reuse the original mirror when a windshield is replaced. If the new windshield comes with a steel mirror button attached, this adapter fits over the button. Then the original mirror can be fitted onto the bracket.
GM & Chrysler 1981 - On

UNIT PACKAGE: 3

Sec. 17

GLASS SHOP SUPPLIES

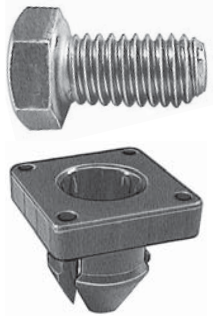

19281
(F5RZ-5421416B)

Door Window Glass to
Regulator Fastener Assembly
3/8"-16 x 3/4"
Grade 8 Cap Screw
Ford Contour & Mystique
1995 - On

UNIT PACKAGE: 2 Sets



20309
(5008055AA)
Natural Nylon

Window to
Regulator
Grommet

Screw Size: #14 (M6.3)
Overall Length: 57mm
Stem Length: 10mm
Fits into 13mm Hole
Dodge Neon 2000 - On

UNIT PACKAGE: 15



17073
(20085729)
Nylon

Window Regulator Drive Block
used with Window
Regulator Tape
GM 1980 - On

UNIT PACKAGE: 25

16959

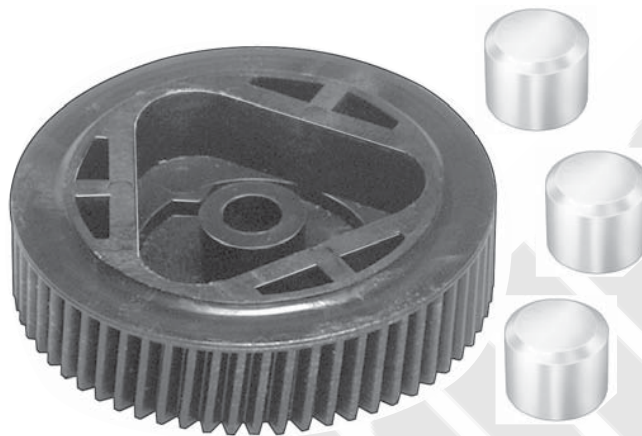

Photo not actual size

Piano Wire
For Cutting through Sealant on
Windshields without Gaskets
Solid not Braided Wire
1/4 Pound (approx. 160 Ft.)
Wire Diameter: .025"

UNIT PACKAGE: 1 Roll

18947



Power Window Regulator Gear & Rollers
Splines: 62
Ford 1989 - On

UNIT PACKAGE: 1



19786

(Not Available from O.E.M.)
Natural Nylon

Torque Pin Kit for
Window Regulator Gear
Pin Diameter: 1/2"
Pin Length: 13/32"
Ford 1964 - On

UNIT PACKAGE: 15



17974
(D0AZ-62234A24)

Power Window
Regulator Gear
Tooth: 9
Splines: 45
Ford 1964 - On

UNIT PACKAGE: 1

HORNS

Photos not actual size

O.E.M. Replacement Horns

19017



Domestic Vehicles - Low Note
Terminals: One/Two
Frequency (Hz): 400
Decibel Rating at 4": 125
Current Draw (Amps): 6
Power Source Volts: 12

UNIT PACKAGE: 1

19019



Import Vehicles - Low Note
Terminals: One/Two
Frequency (Hz): 340
Decibel Rating at 4": 130
Current Draw (Amps): 5
Power Source Volts: 12

UNIT PACKAGE: 1

19018



Domestic Vehicles - High Note
Terminals: One/Two
Frequency (Hz): 500
Decibel Rating at 4": 125
Current Draw (Amps): 6
Power Source Volts: 12

UNIT PACKAGE: 1

19020



Import Vehicles - High Note
Terminals: One/Two
Frequency (Hz): 425
Decibel Rating at 4": 130
Current Draw (Amps): 5
Power Source Volts: 12

UNIT PACKAGE: 1

Freeway Blaster Horns ("Big Rig" Sound)

19021



Low Note
Terminals: One/Two
Frequency (Hz): 400
Decibel Rating at 4": 130
Current Draw (Amps): 6
Power Source Volts: 12

UNIT PACKAGE: 1

19022



High Note
Terminals: One/Two
Frequency (Hz): 500
Decibel Rating at 4": 130
Current Draw (Amps): 6
Power Source Volts: 12

UNIT PACKAGE: 1

Sec. 18

HORNS



Riviera Air Horns & Compressor Kit

19023

Photo not actual size

The Riviera air-powered dual horns sound simultaneously and have the "European" sound. Comes complete with a 12 volt compressor, relay, tubing and mounting hardware.

UNIT PACKAGE: 1 Set



19024

Photo not actual size

Horn Relay
12 Volt

UNIT PACKAGE: 1

Horn Application Guide

Year	Make & Model	Original Equipment Replacement	Freeway Blaster (Optional)
ACURA			
12-90	All Models	*19022 & 19021	
AMC			
90-79	Alliance, Encore, Talon	19019 & 19020	19022 & 19021
90-74	All Other Models	19018 & 19017	19022 & 19021
AUDI			
12-73	All Models	*19018	*19022
BMW			
12-95	5, 7, & 9 Models	19018 & 19017	19022 & 19021
12-74	All Other Models	19019 & 19020	19022 & 19021
BUICK			
12-86	All Other Models	19022 & 19021	
96-75	Skyhawk & Skylark	*19018	*19022
CADILLAC			
12-75	All Other Models	19022 & 19021	
83-81	Cimarron	*19018	*19022
CHEVROLET			
12-76	Aveo, Beretta, Cavalier, Celebrity, Chevette, Citation, Corsica, Spectrum, Sprint & Nova	*19018	*19022
12-71	Corvette	19022 & 19021	
12-71	All Other Models	19018 & 19017	19022 & 19021
CHEVROLET LIGHT DUTY TRUCKS & VANS			
12-75	S-10	19018 & 19017	19022 & 19021
12-75	All Other Models	19022 & 19021	
CHRYSLER			
12-77	All Other Models	19018 & 19017	19022 & 19021
10-95	Sebring	19019 & 19020	19022 & 19021
97-87	LeBaron & GTS	19018	*19021
DODGE			
12-74	All Other Models	19018 & 19017	19022 & 19021
05-95	Neon	*19020	*19022

Year	Make & Model	Original Equipment Replacement	Freeway Blaster (Optional)
DODGE			
99-87	Charger, Lancer, Omni, Shadow, Spirit	*19018	*19022
98-74	Challenger, Colt	*19020	*19022
DODGE LIGHT DUTY TRUCKS & VANS			
12-87	Dakota, Ram, Pickup, Caravan	*19021	
12-75	All Other Models	19022 & 19021	
FORD			
12-07	Edge	19018 & 19017	19022 & 19021
12-01	Escape	19018 & 19017	19022 & 19021
12-71	Escort, Fairmont, Festiva, Focus, Maverick Mustang II, Pinto, Tempo, Contour	*19018	*19022
12-70	All Other Models	19022 & 19021	
97-77	Fiesta	19020	19022
FORD LIGHT DUTY TRUCKS & VANS			
12-85	All Other Models	19022 & 19021	
90-75	Ranger, E 150/350 Vans, Aerostar, Economize	*19022	
GEO			
12-90	All Other Models	*19019	*19021
99-90	Storm	19019 & 19020	19022 & 19021
GMC LIGHT DUTY TRUCKS & VANS			
12-75	All Other Models	19018 & 19017	19022 & 19021
92-91	Jimmy, Sonoma	*19021	
HONDA			
12-80	Civic, Civic Del Sol	*19020	*19022
12-73	All Other Models	19019 & 19020	19022 & 19021
HYUNDAI			
12-86	All Other Models	19019 & 19020	19022 & 19021
87-84	Pony	19020	19022

HORN APPLICATION GUIDE

Sec. 18

Year	Make & Model	Original Equipment Replacement	Freeway Blaster (Optional)	Year	Make & Model	Original Equipment Replacement	Freeway Blaster (Optional)
INFINITI				PLYMOUTH TRUCKS & VANS			
12-90	All Models	19022 & 19021		01-74	All Models	*19017	*19021
ISUZU				PONTIAC			
12-83	Impulse, Stylus, Trooper	19019 & 19020	19022 & 19021	10-95	Trans Sport Montana	19018 & 19017	19022 & 19021
12-81	I Mark, Amigo, Pickup, Rodeo	*19020	*19022	10-75	All Other Models	19018 & 19017	19022 & 19021
JAGUAR				94-93	Trans Sport	*19017	*19021
12-72	All Models	19022	19021	94-82	Astre, J-2000, T-1000, LeMans, Sunbird	19019	*19021
JEEP				87-84	Fiero	19019 & 19020	19022 & 19021
12-74	Cherokee, Grand Cherokee	19022 & 19021		PORSCHE			
12-70	CJ, DJ, Scrambler, Wrangler	*19018	*19022	12-70	All Models	19018 & 19017	19022 & 19021
LEXUS				RANGE ROVER			
12-90	All Models	19022 & 19021		12-01	All Models	19022 & 19021	
LINCOLN-MERCURY				SAAB			
12-74	All Other Models	19022 & 19021		12-79	All Models	19019 & 19020	19022 & 19021
99-71	Capri & Capri II	*19020	*19022	SATURN			
99-71	Bobcat, Lynx, Zephyr, Tracer, Mystique, Topaz	*19018	*19022	10-07	Outlook	19018 & 19017	19022 & 19021
MAZDA				10-90	All Other Models	*19019	*19021
12-91	Navajo	19018 & 19017	19022 & 19021	SUBARU			
12-75	All Other Models	19019 & 19020	19022 & 19021	12-78	All Other Models	19019 & 19020	19022 & 19021
12-71	RX-2, RX-3, Mizer, MX-3, MX-5, Protege, GLC Wagon, B2200, B2601	*19020	*19022	94-87	Justy, Samurai	*19019	*19021
MAZDA TRUCK				SUZUKI SUV			
12-78	All Models	*19019	*19021	12-88	All Models	*19019	*19021
MERCEDES				TOYOTA			
12-73	All Models	19022 & 19021		12-91	Avalon, Camry	19018 & 19017	19022 & 19021
MITSUBISHI				12-80	Starlet, Tercel Sedan, Corolla Coupe, Sedan, Liftback	*19021	*19022
12-83	All Models	19019 & 19020	19022 & 19021	12-72	All Other Models	19018 & 19017	19022 & 19021
NISSAN				TOYOTA TRUCK			
12-97	All Models	19018 & 19017	19022 & 19021	12-81	Land Cruiser & Other Models	19022 & 19021	
96-74	All Other Models	19019 & 19020	19022 & 19021	12-70	4-Runner, Pickup, Van, Paseo	*19020	*19022
90-87	Pulsar	*19020	19022	80-69	Land Cruiser	*19020	*19022
NISSAN TRUCK				VOLKSWAGEN			
12-93	Quest	19018 & 19017	19022 & 19021	12-80	Jetta, Quantum, Fox, Golf, Passat	19019 & 19020	19022 & 19021
12-82	All Other Models	19019	*19021	12-74	All Other Models	*19019	*19021
OLDSMOBILE				VOLVO			
04-91	Bravada	*19017	*19021	12-70	All Other Models	19019 & 19020	19022 & 19021
04-98	Alero	19018 & 19017	19022 & 19021	97-84	240-740-760 Series	*19020	*19022
04-74	All Other Models	19022 & 19021	*19021				
89-88	Firenza	19018	19022				
PLYMOUTH							
01-75	All Other Models	*19018	*19022				
89-71	Arrow, Champ, Colt, Laser	*19020	*19022				

*One horn is standard; however, vehicle may be equipped with optional second horn for better sound. Add another horn of opposite note (high or low).

Sec. 19

TRIMMING SUNDRIES & FASTENERS



1720

Door and Quarter Trim
Panel Fastener
Chrysler

UNIT PACKAGE: 100



2385

Door Trim
Panel Fastener
Chrysler

UNIT PACKAGE: 100



2309

Door Trim Panel Fastener
All cars with .125 Panels
Ford

UNIT PACKAGE: 100



808

General Purpose
Head Diameter: 1/2"
Chrysler

UNIT PACKAGE: 100



8206

Door Trim
Panel Fastener
Ford

UNIT PACKAGE: 100



2310

Door Trim
Panel Fastener
Chrysler

UNIT PACKAGE: 100

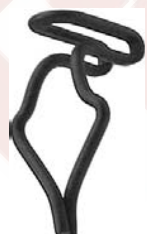

11863

(383033-S101)
Phosphate

Door Trim
Panel Fastener
Ford

UNIT PACKAGE: 50

10780

Same as 11863 except for unit packaging quantity

UNIT PACKAGE: 100



807

General Purpose
Head Diameter: 1/2"
Chrysler

UNIT PACKAGE: 100



9361

(Ford: 358470; Chry: 1900654)

Door Trim Panel Fastener
Ford & Chrysler

UNIT PACKAGE: 100



2272

(358107)

Body Belt Moulding &
Hood Side Moulding Fastener
Ford

UNIT PACKAGE: 100



1256

(353123)

Rear Quarter Strip (Inside),
Instrument Panel Moulding & Hood
Side Moulding Fastener
Ford & Chrysler

UNIT PACKAGE: 50



11406

Trim Clip Fastener
Head Diameter: 1/2"
Fits into 1/4" Hole

UNIT PACKAGE: 100



18402

Phosphate & Green

Weatherstrip Clip
GM

UNIT PACKAGE: 25



18395

Black Phosphate

Weatherstrip Clip
GM

UNIT PACKAGE: 50



12134

(4114785)
Zinc

Trim Panel Fastener
Fits into 5/16" Hole
Chrysler

UNIT PACKAGE: 50

Bulk Quantities

The items listed below are available in bulk quantities of 25,000 or more. Quotation on Request

- A = Head O.D.
- B = Prong Length
- C = Hole Size
- D = Width of Diamond



5961

Brown

General Purpose

- A: 17/32"
- B: 7/8"
- C: 9/32"
- D: 1/2"

UNIT PACKAGE: 100



1202

Sandstone

General Purpose

- A: 17/32"
- B: 1-17/64"
- C: 9/32"
- D: 7/16"

UNIT PACKAGE: 100

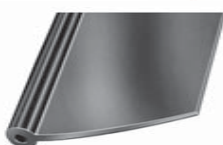

V-875

Fender Welt

1-3/8 inch (3/16" Bead)
Bright Smooth Vinyl Bead

UNIT PACKAGE: 50 Feet

Footman Loops



Auveco Part No.	Size	Hole Size	Hole Ctr. to Hole Ctr.	Overall Length	Unit Pkg.
-----------------	------	-----------	------------------------	----------------	-----------

Steel-Nickel Plated

7771	For 1" Strap	7/32"	2-1/8"	2-5/8"	25
7772	For 1-1/4" Strap	1/4"	2-1/4"	2-3/4"	25
7773	For 1-1/2" Strap	1/4"	2-5/8"	3-1/8"	25
19401	For 2" Strap	1/4"	3-1/8"	3-21/32"	25

Steel • Black E • Coat Plated (168 Hrs. Salt Spray)

19404	For 1-1/2" Strap	1/4"	2-5/8"	3-1/8"	25
-------	------------------	------	--------	--------	----

Hog Rings

To attach seat covers to cushions and seat bottoms, as well as, cushion spring clips.



7595

Medium
.080" Wire Diameter

UNIT PACKAGE: 500



7644

Large
.088" Wire Diameter

UNIT PACKAGE: 500



12671

3/4" Nail (.750)
"Nail On" Door Panel Repair Clip
Slips on Door Panel Fastener Strip for repairs to replace broken Nails in Panel Edging
Replaces Auveco No. 7585 GM

UNIT PACKAGE: 50



12069

(416629)
Zinc

Upholstery Clips
GM 1979-On

UNIT PACKAGE: 50



9417

Snap-On Trim Clip
Panel Range: .105"-.115"

UNIT PACKAGE: 100



9416

Snap-On Trim Clip
Panel Range: .060"-.090"

UNIT PACKAGE: 100



7578

Seat Cushion Upholstery Clip
Can be used to repair drooping headliners in Honda.

UNIT PACKAGE: 500

Sec. 19

TRIMMING SUNDRIES & FASTENERS



7707

Cloth Lined Cushion Spring Clip
to fasten Springs to each
other or to border Wire.
Length: 7/8"
For 1/4" or two 8 Gauge Wires.

UNIT PACKAGE: 100



11795

Zinc

Seat Cover Clip
GM 1978-On

UNIT PACKAGE: 100



2850

Front Seat
Self-Locking Clip
Ford

UNIT PACKAGE: 100



8665

Front Seat
Rod End Nut
Outer Diameter: 15/16"
Stud Size 1/2"
Chrysler

UNIT PACKAGE: 100



8719

(4000155)
Nickel

Front Seat Inner Bracket Nut
Outer Diameter: 11/16"
Stud Size: 3/8"
Rambler

UNIT PACKAGE: 100



2672

Front Seat
Hinge Arm Clip
GM

UNIT PACKAGE: 100



Grommets and Washers
Solid Brass

7347	3/8" Hole	Size No. 2
7348	7/16" Hole	Size No. 3
7349	1/2" Hole	Size No. 4
7350	5/8" Hole	Size No. 5

NOTE: Grommets and Washers bagged separately.

UNIT PACKAGE: 144 Grommets & 144 Washers



**Grommet
Setting Dies**



7342	- For Grommet 7348	7/16" Hole-Size No. 3
7343	- For Grommet 7349	1/2" Hole-Size No. 4
7344	- For Grommet 7350	5/8" Hole-Size No. 5

UNIT PACKAGE: 1 SET



**Flanged Type
Countersunk Washers**

Screw Size	I.D.	O.D.	Nickel on Brass Part No.	Black Zinc on Brass Part No.	Stainless Steel Part No.	Unit Pkg.
#6	5/32"	1/2"	3469		3470	100
#8	13/64"	5/8"	2515	16009	2597	100
#10	1/4"	11/16"	3471		3472	100



Flush Type Washers
Nickel Plated on Brass

Unit Pkg. 100	Unit Pkg. 144	Unit Pkg. 1000	Screw Size	I.D.	O.D.
602	7137	7624	#6	5/32"	11/32"
604	7138	7625	#8	3/16"	3/8"
16015		16016	#10	13/64"	15/32"



Countersunk Type Washers

Screw Size	I.D.	O.D.	Nickel Plated Brass			Black Zinc Plated Brass		Plain Brass	
			Unit Pkg. 100	Unit Pkg. 144	Unit Pkg. 1000	Part No.	Unit Pkg.	Part No.	Unit Pkg.
#4	9/64"	3/8"	612		7613				
#6	11/64"	7/16"	614	7143	7615	16011	100		
#8	13/64"	1/2"	616	7145	7616	16012	100		
#10	1/4"	19/32"	618	7147	7618	16013	100	16593	100
#12	9/32"	11/16"	619	7148					

TRIMMING SUNDRIES & FASTENERS

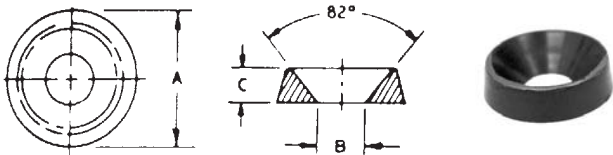

Nylon Finishing Washers

Available in natural or black nylon, these molded washers protect cabinets from scratching, cover misaligned holes, etc. May also be used as guides, bumpers and spacers.

Auveco Part No.	Screw Size	O.D. (A)	I.D. (B)	Thickness (C)	Color	Unit Pkg.
13717	#6	.437" (11.10mm)	.143" (3.63mm)	.100" (2.54mm)	Black	50
13718	#8	.515" (13.08mm)	.171" (4.34mm)	.115" (2.92mm)	Natural	50
13719	#8	.515" (13.08mm)	.171" (4.34mm)	.115" (2.92mm)	Black	50
13720	#10	.580" (14.73mm)	.191" (4.85mm)	.152" (3.86mm)	Natural	50
13721	#10	.580" (14.73mm)	.191" (4.85mm)	.152" (3.86mm)	Black	50
13723	#12	.609" (15.47mm)	.225" (5.72mm)	.160" (4.06mm)	Black	50
13724	#14	.683" (17.35mm)	.251" (6.38mm)	.183" (4.65mm)	Natural	50
13725	#14	.683" (17.35mm)	.251" (6.38mm)	.183" (4.65mm)	Black	50

Pop on Screw Covers & Bases

Covers: Matte Finish



Ultra Violet Stabilized Polypropylene covers and bases help shield screws from corrosive environments. Their smooth finish forms a protective barrier against rough-edges.

For use with flat head and oval head tap ping screws and round head machine screws.

They're simple to use:

1. Place washer over pilot or starting hole for screw, nail or rivet.
2. Install fastener
3. Place Snap Cap over washer at slight angle.
4. Simply push Snap Cap down firmly.

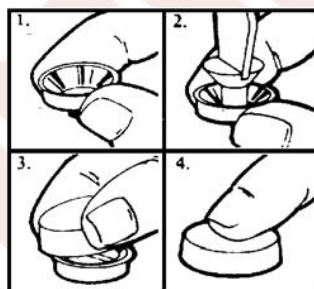

Screw Cover Bases

Auveco Part No.	Unit Pkg.	Screw Size
13839	50	#4
13840	50	#6
13841	50	#8
13842	50	#10

Screw Covers

Auveco Part No.	Unit Pkg.	Color
13831*	50	Black
13832*	50	White
13833*	50	Black
13834*	50	White
13835•	50	Black
13836•	50	White
13837•	50	Black
13838•	50	White

* 1/2" O.D.

• 5/8" O.D.



19413

(F7UZ-15238A32)
Black Nylon

Door Panel Screw Cover
Head Diameter: 3/4" (19mm)
Fits into 5/8" (16mm) Hole
Ford Econoline E150 1997-On

UNIT PACKAGE: 25

Accessories for use on Landau Tops



9877

Stainless Steel

#4-24 x 3/8"
Head Diameter: 7/32"
Type AB

Used in place of Welded Studs on Landau Tops

UNIT PACKAGE: 100



9850

(7731589)
Natural Nylon

Landau Top Moulding Clip
Use with Auveco Screw 9877

UNIT PACKAGE: 100



10632

Nylon

Landau Top Moulding Clip
Use with Auveco Screw 9877

UNIT PACKAGE: 100



11485

(1729250)
Nylon

Roof Transverse Moulding Clip
GM 1976-On

UNIT PACKAGE: 25

Sec. 19

TRIMMING SUNDRIES & FASTENERS



9342
(4459049)
Nylon

Door Trim Pad Grommet
Screw Size: #8 or #10
Stem Length: 9/16"
Buick & Oldsmobile

UNIT PACKAGE: 50



3617
(6280765)
Nylon

Door Trim Pad Grommet
Screw Size: #4
Stem Length: 7/16"
Chevrolet & Oldsmobile

UNIT PACKAGE: 100



18398
(20058837)
Nylon

Windshield Upper
Garnish Clip
GM A & G Models
1988-78

UNIT PACKAGE: 10



16865
(20462090)
Nylon

Garnish Moulding Clip
Buick Century & Regal,
Chevrolet Camaro, Celebrity,
Monte Carlo & Malibu, Oldsmobile
Cutlass & Ciera, Pontiac Firebird
Grand Prix & 6000 1978-On

UNIT PACKAGE: 25



11118
(9617200)
Nylon

Headliner Clip
Inner Side Front, Center & Rear
GM 1973-On

UNIT PACKAGE: 10

11119

Same as 11118 except for unit package quantity

UNIT PACKAGE: 100



17666
(20632190)
Nylon

Garnish Moulding Clip
Back Window Upper & Side
Moulding Garnish

Buick LeSabre, Cadillac, Fleetwood Brougham,
Chevrolet Caprice & Impala, Olds Delta 88 & 98,
Pontiac Bonneville & Parisienne 1989-80

UNIT PACKAGE: 10

HAVE YOU VISITED US ONLINE?

**Auveco's website has been completely renovated.
Our new design is user friendly with easy navigation and ordering.**

Product is searchable by car make, OEM number and category, as well as, several attribute drop downs within individual categories. All product also has stock availability listed.

**Make sure to head over to
www.auveco.com
to receive up to date information on all our products.**

SNAP FASTENERS & ACCESSORIES

Sec. 19



Button
Nickel on Brass
11/64" Barrel Length

14830 - Black Delrin Cap
UNIT PACKAGE: 50

7677 - Nickel Cap
UNIT PACKAGE: 100



Socket
Nickel on Brass

7678 - Normal Action
UNIT PACKAGE: 100



Stud
Nickel on Brass

7679 - Clinch Type
UNIT PACKAGE: 100



Eyelet
Nickel on Brass

7682 - 1/4" Barrel Length
UNIT PACKAGE: 100

Buttons 7677 and 14830 assemble with socket 7678.

You can use hand tools 7690 and 7691 or hand press tool 14835 to complete this step.

Stud 7679 assembles with eyelet 7682.

You can use hand tools 7691 and 7692 or hand press tool 14835 to perform this step.

The two assembled units then snap together.

An assembled button (7677, 14830) and socket (7678) unit can be used with fasteners listed below.



Phillips Wood Screw
Nickel on Brass

9814 - #8 x 3/8"
7680 - #8 x 5/8"
UNIT PACKAGE: 100



Phillips Head
Stainless Steel Screw

14833 - #8 x 3/8"
14834 - #8 x 5/8"
15687 - #10 x 5/8"
UNIT PACKAGE: 50



Phillips Head
16418 - #8 x 1/2"
Nickel on Brass

16419 - #8 x 3/4"
Stainless Steel Screw

UNIT PACKAGE: 25



Wood Screw Stud
Nickel on Brass

7688 - #7 x 1/2"
UNIT PACKAGE: 100



7690

Height: 5/8"
Diameter: 1-3/8"
Die for assembling buttons 7677 & 14830 with socket 7678. The button sets in the die. Then the material and socket are placed over the button barrel. Tool 7691 is used to swedge over the barrel.
UNIT PACKAGE: 1



7692

Height: 5/8"
Diameter: 1-3/8"
Die for assembling stud 7679 and eyelet 7682. The eyelet sets in the die. Then the material and stud are placed over the eyelet barrel. Tool 7691 is used to swedge over the barrel.
UNIT PACKAGE: 1

7691



Length: 3-1/4"
Tool for assembling buttons 7677 & 14830 with socket 7678 and stud 7679 with eyelet 7682.

UNIT PACKAGE: 1

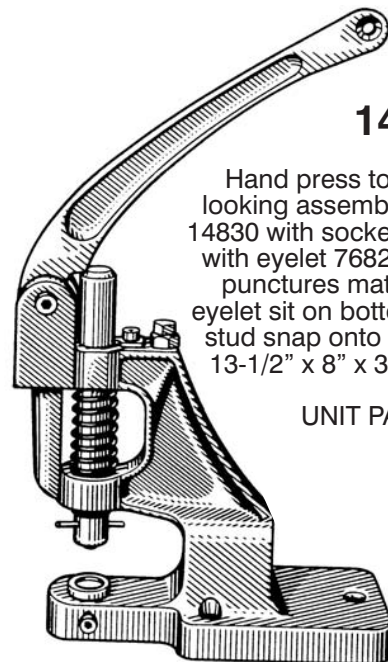

14835

Hand press tool for professional looking assembly of buttons 7677 & 14830 with socket 7678 and stud 7679 with eyelet 7682. Tool automatically punctures material. Buttons and eyelet sit on bottom dies. Socket and stud snap onto dies on the plunger. 13-1/2" x 8" x 3-1/2". Weighs 8 lbs.

UNIT PACKAGE: 1

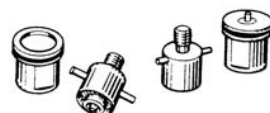

Sec. 19

CURTAIN FASTENERS

Nickel on Brass



7417

Backplate
Single curtain to
clinch with backplate

UNIT PACKAGE: 100



7409

Eyelets & washers
**Use with Auveco Fasteners
7417 and 7419**

UNIT PACKAGE: 100 Sets



7419

Single curtain
Use with #4 stainless steel,
chrome or brass screws
(screws sold separately)

UNIT PACKAGE: 100



7432

Photo not actual size
Tool for cutting holes in material when
installing 7409 eyelet and washer.
Overall Length: 6-11/16"

UNIT PACKAGE: 1

TRIMMING SUNDRIES & FASTENERS

Refer to Retainer Specification Chart on pages 415 - 489



19746

(91652-SZ3-003)
White Nylon

Door Lining Retainer
Acura 3.5RL 1996 - On

UNIT PACKAGE: 10



21548

(67869-20030)
Black Nylon

Weatherstrip Retainer
Lexus IS 300 & SC 430 and Toyota Camry,
Celica, Corolla, Highlander, Matrix, MR-2, Prius,
RAV-4, Scion, Solara & Supra 1990 - On

UNIT PACKAGE: 25



18684

(10262036)
Black Nylon

Control Panel Trim Retainer
Chevrolet Lumina & Monte Carlo 1995-On

UNIT PACKAGE: 100



14367

(9924-90-512B)
Black Nylon

Retainer
Mazda

UNIT PACKAGE: 50



21627

(67868-30030)
Black Nylon

Door & Roof Rail Retainer
Lexus 2006 - On & Toyota 1974 - On

UNIT PACKAGE: 25



21984

(VW: 6Y0-823-717)
Black Nylon

Trim Panel Retainer
VW, Audi, SEAT & Skoda

UNIT PACKAGE: 15



21458

(91567-S3M-000)
Black Nylon

Weatherstrip Retainer
Honda Accord, Civic & Odyssey 2003 - On

UNIT PACKAGE: 25



18683

(10063599)
Black Nylon

Remote Control Door
Lock Receiver Retainer
Chevrolet Lumina & Monte Carlo,
Oldsmobile Cutlass and Pontiac
Bonneville & Grand Prix 1991 - On

UNIT PACKAGE: 100



19686

(90467-05045-22)
Black Nylon

Weatherstrip Retainer
Toyota Solara 1998 - On

UNIT PACKAGE: 25

TRIMMING SUNDRIES & FASTENERS

Refer to Retainer Specification Chart on pages 475-489



18770
(3759944)
Black Nylon

Cowl & Dash Panel Retainer
Dodge Shadow & Plymouth Sundance
1988 - On

UNIT PACKAGE: 50



20344
(10169777)
Black Nylon

Weatherstrip Retainer
Replaces Auveco 18322
Chevrolet Impala, Lumina & Monte Carlo
and Pontiac Aztek 1995 - On

UNIT PACKAGE: 25



14921
(GM: 20699808; Chry: 6502328)
Black Nylon

Door Weatherstrip Retainer
GM 1974 - On
Dodge Ram 1994 - On

UNIT PACKAGE: 50



18389
(25603960)
Black Nylon

Radiator Baffle
Retainer
Olds 98 Regency 1994 - On

UNIT PACKAGE: 25



20165
(4658887)
Black Nylon

Trim Panel Retainer
Chrysler LH & LHS Series 1997 - On

UNIT PACKAGE: 50



14021
(N803170-S)
Black Nylon

Fascia Retainer
Ford Mustang & Capri 1984 - On

UNIT PACKAGE: 25



20528
(24205245)
Black Nylon

Rear Bumper Cover Retainer
Chevrolet Cavalier & Pontiac Sunfire
1995 - On

UNIT PACKAGE: 50



21936
(Peugeot & Citroen: 6992.07)
Black Nylon

Trim Panel Retainer
Peugeot & Citroen

UNIT PACKAGE: 25



11129
(2964547)
Black Nylon

Weatherstrip Retainer
Chrysler 1977 - On

UNIT PACKAGE: 25



11120
(8731909)
Black Nylon

Door Weatherstrip Retainer
GM 1963 - On

UNIT PACKAGE: 100



21808
(Peugeot & Citroen: 6992.31)
White Nylon

Interior Trim Retainer
Peugeot & Citroen

UNIT PACKAGE: 25



18302
(GM: 20538173; Chry: 6104908-AA;
Mercedes: 002-997-33-86-67)
Black Nylon

Weatherstrip Retainer
Buick Century & Riviera, Chevrolet Lumina, Olds
Aurora & Regency and Pontiac Grand Prix 1989 - On
Chrysler 2008 - On
Mercedes-Benz

UNIT PACKAGE: 50

Sec. 19

TRIMMING SUNDRIES & FASTENERS

Refer to Retainer Specification Chart on pages 475-489



21855
(Land Rover: MXC1800)
Black Nylon

Door Panel Retainer
Defender & Discovery Series 1997 - On

UNIT PACKAGE: 15



18298
(22536642)
Black Nylon

Rear Bumper Fascia Retainer
Chevy Cavalier, Olds Calais, Pontiac
Grand Prix, Sunbird & 6000 1988 - On

UNIT PACKAGE: 50



21770
(Land Rover: MWC9134)
Black Nylon

Side Door Trim Panel Retainer
Use with Auveco 22085
Defender Series, Discovery Series,
Freelander & Range Rover 2006 - 1989

UNIT PACKAGE: 25



19673
(72311-S10-003)
Black Nylon

Weatherstrip Retainer
Honda CRV 1997 - On

UNIT PACKAGE: 15



14006
(20455900)
Black Nylon

Moulding Retainer
GM 1984 - On

UNIT PACKAGE: 25



20311
(N803857S)
Black Nylon

Front End Fascia Retainer
Replaces Auveco 15483
Ford Aerostar, LTD & Marquis 1985 - On

UNIT PACKAGE: 50



21519
(01553-01A50)
Black Nylon

Bumper & Trim Retainer
Infiniti FX35, G35, G37, M35, M45 & Q45
and Nissan 350Z & 370Z 1997 - On

UNIT PACKAGE: 25



11721
(411700)
Black Nylon

Trim Panel Retainer
GM 1968-On

UNIT PACKAGE: 50



17634
(01553-01781)
Black Nylon

Cowl Grille Retainer
Nissan 240SX 1990 - On

UNIT PACKAGE: 25



19149
(4658673)
Black Nylon

Weatherstrip Retainer
Front & Rear Doors
Chrysler Neon 1996-On

UNIT PACKAGE: 50



20893
(GM: 10293193;
Ford: N811040-S)
Black Nylon

Hood Insulation &
Door Weatherstrip Retainer
Chevrolet Cobalt &
Ford Mustang 2005 - On

UNIT PACKAGE: 50



18948
(GM: 1644290; Nissan: 01553-0075U)
Black Nylon

Hood Insulation, Rear Bumper Fascia
& Door Trim Plate Retainer
GM 1991 - On
Nissan: 2002 - On

UNIT PACKAGE: 25



18897
(10078274)
Black Nylon

Side Roof Rail
Weatherstrip Retainer
Chevrolet Corsica & Beretta 1989 - 87

UNIT PACKAGE: 25

TRIMMING SUNDRIES & FASTENERS

Refer to Retainer Specification Chart on pages 475-489



11680

(25016383)
Black Nylon

Dash Panel Retainer
GM 1977 - On

UNIT PACKAGE: 50



11612

(GM: 20413107;
Ford: 388246S
AMC: 4006516)
Black Nylon

Weatherstrip Retainer
GM, Ford & AMC

UNIT PACKAGE: 50



14289

(90666-SA0-003)
Black Nylon

Retainer
Honda

UNIT PACKAGE: 25



19836

(6505417AA)
Black Nylon

Trim Panel Retainer
Chrysler

UNIT PACKAGE: 50



21800

(Renault: 77-03-077-080)
Black Nylon

Retainer
Renault and Dacia

UNIT PACKAGE: 25



21801

(Not Available from O.E.M.)
White Nylon

Retainer
Renault and Dacia

UNIT PACKAGE: 25



12993

(7703-077-066)
Black Nylon

Rear Window Moulding
AMC Renault & Alliance 1983 - On

UNIT PACKAGE: 25



21802

(Renault: 77-03-077-231;
Fiat: 14591787)
Black Nylon

Retainer
Renault, Dacia
and Fiat

UNIT PACKAGE: 25

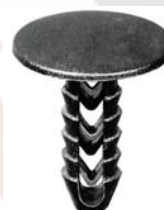

21803

(Fiat: 14592087)
Black Nylon

Retainer
Renault, Dacia and Fiat

UNIT PACKAGE: 25



21804

(Fiat: 14592086)
Gray Nylon

Retainer
Renault, Dacia and Fiat

UNIT PACKAGE: 25



14017

(390126-S)
Black Nylon

Fascia Retainer
Ford Mustang &
Capri 1984 - On

UNIT PACKAGE: 25

14857

Same as 14017 except for unit package quantity

UNIT PACKAGE: 50

All items available in bulk quantities.

**Call customer service 1-800-354-9816
for a price quote**

Sec. 19

TRIMMING SUNDRIES & FASTENERS

Refer to Retainer Specification Chart on pages 475-489



21878
(Peugeot & Citroen: 8964.57)
Black Nylon

Trunk Lining Retainer
Peugeot & Citroen

UNIT PACKAGE: 25



21693
(Lexus: 90467-05125)
Black Nylon

Front Bumper Bracket Retainer
Lexus GS 300, GS 450h
& LS 400 1995 - On

UNIT PACKAGE: 25



18682
(10098645)
Black Nylon

Front Door Lower Moulding Retainer
Pontiac Grand Prix with
Sport Performance Package 1994 - On

UNIT PACKAGE: 50



21303
(90671-S0D-003ZK)
Black Nylon

Trunk Lid &
Interior Trim Retainer
Honda Accord 2010 - On

UNIT PACKAGE: 25



20256
(01553-01182)
Black Nylon

Splash Shield Retainer
Nissan Frontier Truck 1997 - On

UNIT PACKAGE: 50



21877
(Peugeot & Citroen: 6992.C6)
Black Nylon

Radiator Panel Retainer
Peugeot & Citroen

UNIT PACKAGE: 25



17453
(B003-68-865-96)
Gray Nylon

Rear Compartment
Interior Trim Retainer
Ford Probe 1988 - On
Mazda MX6 1988 - On

UNIT PACKAGE: 50



21589
(99045AE03AMA)
Black Nylon

Trim Panel Retainer
Subaru B9 Tribeca, Impreza,
Legacy & Outback 2005 - On

UNIT PACKAGE: 25



21755
(Mazda: B003-68-865-00)
Black Nylon

Trim Panel Retainer
MPV 1998 - 89

UNIT PACKAGE: 50



18815
(6502381)
Black Nylon

Radiator Grille
Sight Shield Retainer
Dodge Caravan &
Plymouth Voyager 1993 - On

UNIT PACKAGE: 50



19312
(90467-05096-22)
Black Nylon

Luggage Compartment
Trim Panel Retainer
Toyota Tercel & Paseo 1994 - On

UNIT PACKAGE: 25



21910
(Renault & Dacia: 77-03-077-487)
Black Nylon

Trim Panel Retainer
Renault & Dacia

UNIT PACKAGE: 25

TRIMMING SUNDRIES & FASTENERS

Refer to Retainer Specification Chart on pages 475-489



21911
(Renault & Dacia: 77-03-077-464)
Gray Nylon

Trim Panel Retainer
Renault & Dacia

UNIT PACKAGE: 15



21912
(Renault & Dacia: 77-03-077-153)
Black Nylon

Trim Panel Retainer
Renault & Dacia

UNIT PACKAGE: 15



21913
(Renault & Dacia: 77-03-077-107)
Dark Gray Nylon

Trim Panel Retainer
Renault & Dacia

UNIT PACKAGE: 25



19506
(90666-SA7-003ZW)
Black Nylon

Trunk Lining Retainer
Acura 2.5TL, 3.2TL, 3.5, Integra &
Legend, Honda Accord Wagon
& Prelude 1987 - On

UNIT PACKAGE: 15



21938
(Peugeot & Citroen: 7588.VX)
Black Nylon

Trim Panel Retainer
Peugeot & Citroen

UNIT PACKAGE: 25



21349
(85746-06000LX)
Gray Nylon

Headliner Retainer
Kia Rio 2010 - On

UNIT PACKAGE: 25



21350
(85746-06000RU)
Tan Nylon

Headliner Retainer
Kia Rio 2010 - On

UNIT PACKAGE: 25



15050
Black Nylon
Shroud Retainer
High Retention Capability
GM, Ford & Chrysler

UNIT PACKAGE: 50



15367
(20514862)
Black Nylon
Screen Shroud Vent
Grille to Panel Retainer
GM 1985 - On

UNIT PACKAGE: 50



21940
(Peugeot & Citroen: 6992.95)
Black Nylon

Trim Panel Retainer
Peugeot & Citroen

UNIT PACKAGE: 25



11675
(GM: 25514221;
Chry: 6003587)
Black Nylon
Roof Headliner Retainer
GM & Chrysler 1982 - On

UNIT PACKAGE: 50



21199
(Ford: W711687-S300;
GM: 11589181)
Black Nylon
Bumper and Fender Apron Retainer
Ford Focus and GM Full-Size
Pick-Up Trucks 2007 - On

UNIT PACKAGE: 25



14709
(Mazda: G030-68-885-B-38;
Ford: F22Z-16774-A, GA2A-56694)
Nylon
Hood Insulation Retainer
Mazda & Ford Probe

UNIT PACKAGE: 25

Sec. 19

TRIMMING SUNDRIES & FASTENERS

Refer to Retainer Specification Chart on pages 475-489



21661
(TD11-56-694)
Black Nylon

Hood Insulation Retainer
Mazda 3, 5, 6, CX7, CX9,
MX5 Miata & RX8 2004 - On

UNIT PACKAGE: 25



20399
(W701374-S)
Black Nylon

Hood Insulation Retainer
Ford Escape 2001 - On

UNIT PACKAGE: 25



11679
(GM: 20032850; Ford: 387258-S;
Chry: 3861577)
Black Nylon

Mud Shield Retainer
GM, Ford & Chrysler 1976 - On

UNIT PACKAGE: 100



13454
(20511451)
Black Nylon

Cowl Vent Retainer
GM 1984 - On

UNIT PACKAGE: 25



11347
(3861577)
Black Nylon

Front Seat Adjuster Cover Retainer
Chrysler 1975 - On

UNIT PACKAGE: 25



19643
(90467-06175)
Black Nylon

Luggage Compartment
Retainer
Toyota Solara 1998 - On

UNIT PACKAGE: 15



20184
(90467-08186)
Black Nylon

Luggage Compartment
Trim Retainer
Toyota Camry 1999 - On

UNIT PACKAGE: 25



13198
(4-29-29-06)
Black Nylon

Interior Trim Retainer
Fiat

UNIT PACKAGE: 50



18820
(N807951S)
Black Nylon

Access Hole Cover Retainer
Ford Mustang 1994 - On

UNIT PACKAGE: 100



19667
(N801994-S100)
Black Nylon

Trim Panel Retainer
Ford 1982 - On

UNIT PACKAGE: 25



21941
(Peugeot & Citroen: 9128.S1)
Light Gray Nylon

Trim Panel Retainer
Peugeot & Citroen

UNIT PACKAGE: 10



21937
(Peugeot & Citroen: 6992.W9)
Black Nylon

Trim Panel Retainer
Peugeot & Citroen

UNIT PACKAGE: 25



21939
(Peugeot & Citroen: 7589.V4)
Tan Nylon

Trim Panel Retainer
Peugeot & Citroen

UNIT PACKAGE: 15

TRIMMING SUNDRIES & FASTENERS

Refer to Retainer Specification Chart on pages 475-489



21253

(90467-05164-B6)
Gray Nylon

Headliner Retainer
Toyota Yaris 2009 - On

UNIT PACKAGE: 25



21332

(90467-05164-E2)
Tan Nylon

Headliner Retainer
Toyota Corolla & Yaris 2009 - On

UNIT PACKAGE: 25



21560

(G032-68-865A-00)
Black Nylon

Trunk & Carpet Retainer
Mazda B2000, B2600, CX-7, CX-9, Miata,
Millenia, MX-3, MX-5, MX-6, Protege, RX-7,
RX-8, 3, 5, 6, 626 & 929 1987 - On

UNIT PACKAGE: 25



21673

(W715926-S300)
Black Nylon

Fender, Bumper, Trunk
& Interior Trim Retainer
Ford Escape & Focus 2012 - On

UNIT PACKAGE: 25



21630

(95022AC040ML)
Black Nylon

Headliner & Trim
Space Retainer
Subaru Forester, Impreza,
Legacy & Outback 1998 - On

UNIT PACKAGE: 25



14757

(N804448)
Black Nylon

Engine Mount Heat Shield Retainer
Ford Taurus & Sable 1986 - On

UNIT PACKAGE: 25



19470

(90108-SW3-003)
Black Nylon

Use with Auveco 19650
Honda Accord,
Odyssey & Prelude 1995 - On

UNIT PACKAGE: 15



19744

(90669-SP0-003ZA)
Black Nylon

Trunk Trim Retainer
Honda Civic 1998 - On

UNIT PACKAGE: 10



21947

(Peugeot & Citroen: 7437.10)
Black Nylon

Trim Panel Retainer
Peugeot & Citroen

UNIT PACKAGE: 10



19893

(6501948)
Black Nylon

Fender & Bumper Shield Retainer
Chrysler 1995 - 89

UNIT PACKAGE: 50



20334

(90667-SOD-003ZC)
Black Nylon

Trunk Garnish Retainer
Honda Civic 1998 - On

UNIT PACKAGE: 15



22075

(Nissan: 01553-06451)
Black Nylon

Upper Quarter Trim &
Rear Trunk Seal Retainer
Infiniti G35, J30, JX60, M35, M37, M56,
Q45, Q50 & QX60 and Nissan Altima,
Pathfinder & Quest 1996 - On

UNIT PACKAGE: 25



16776

(Honda: 90667-SAO-0030;
Nissan: 76996-01P02)
Black Nylon

Trim Panel Retainer
Honda & Nissan

UNIT PACKAGE: 25

Sec. 19

TRIMMING SUNDRIES & FASTENERS

Refer to Retainer Specification Chart on pages 475-489



19842
(75867-30110)
Black Nylon
Rocker Panel Clip
Toyota Corolla 1997 - On
UNIT PACKAGE: 15



15040
(Chry: 5208743; AMC: 4006529)
Black Nylon
Trim Panel Retainer
Chrysler 1988 - 84
AMC 1988 - 84
UNIT PACKAGE: 50



18379
(W701380SSW)
Black Nylon
Retainer
Trunk Liner, Rear Seat Carpet,
& Radiator Side Shield
Ford Contour &
Mercury Mystique 1995 - On
UNIT PACKAGE: 25



19774
Black Nylon
Bumper Cover Retainer
Replaces Auveco 18106
Postal Vehicles &
General Purpose
UNIT PACKAGE: 25



18174
(25601491)
Black Nylon
Radiator Air Side Baffle
& Door Trim Panel Retainer
Buick LeSabre &
Olds Delta 88 Royale 1992 - On
UNIT PACKAGE: 50



20624
(Ford: W709002-SAA)
Black Nylon
Fender Flare Retainer
Ford Expedition &
Navigator 2003 - On
UNIT PACKAGE: 25



20531
(W708035-S300)
Black Nylon
Rear Bumper Cover Retainer
Use with Auveco 20532
Ford Expedition 2003 - On
UNIT PACKAGE: 25

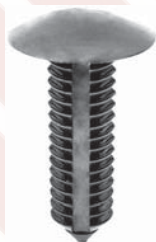

18301
(GM: 10185925; Chry: 6503768)
Black Nylon
Bumper Fascia Retainer
Chevy Lumina APV, Olds Silhouette
& Pontiac Trans Sport 1993 - On
UNIT PACKAGE: 25



21679
(Chrysler: 6509590-AA)
Black Nylon
Bumper Retainer
Chrysler 300 & Charger 2011 - On
UNIT PACKAGE: 25



20177
(W705955-S300)
Charcoal Gray
Nylon
Wheel Opening Moulding Retainer
Ford Explorer 1998 - On
UNIT PACKAGE: 50



16818
(GM: 21094146, 21110201;
Chry: 6501301)
Black Nylon
Trim Panel Retainer
GM Saturn 1991 - On
Sliding Door & Lift Gate
Trim Panel Retainer
Chrysler Mini Vans 1987 - On
UNIT PACKAGE: 25



18859
(10119816)
Black Nylon
Panel Retainer Air Intake
Grille Panel Retainer
Chevrolet Camaro
1991 - On
UNIT PACKAGE: 25

TRIMMING SUNDRIES & FASTENERS

Refer to Retainer Specification Chart on pages 475-489



20761
(W710312-S300)
Black Nylon

Cowl Vent Retainer
Ford Trucks
2004 - On

UNIT PACKAGE: 25



18371
(15986343)
Gray Nylon

Door Trim
Panel Retainer
Chevrolet Astro & GMC Safari
Mini Vans 1994 - On

UNIT PACKAGE: 25



20366
(W701855-S300)
Black Nylon

Fender Liner &
Mud Flap Retainer
Ford Explorer &
Mountaineer 2002 - On

UNIT PACKAGE: 25

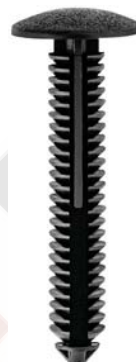

20192
(Ford: W707889-S300)
Black Nylon

Mud Flap Retainer
Ford Expedition &
F-150 1997 - On

UNIT PACKAGE: 25



14032
(15588078)
Black Nylon

Pillar Cover Retainer
GM Truck 1985 - On

UNIT PACKAGE: 10



20926
(W710532-S300)
Black Nylon

Rocker Moulding Retainer
Ford Mustang
2005 - On

UNIT PACKAGE: 25

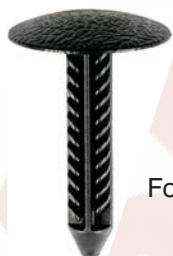

22180
(Ford: W714076-SS3JA)
Black Nylon

Cowl, Interior Trim &
Splash Shield Retainer
Ford F150 & Mustang 2015 - On

UNIT PACKAGE: 25

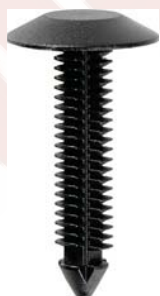

14036
(14074081)
Black Nylon

Rear Hood Seal Retainer
GM 1983 - On

UNIT PACKAGE: 25



14035
(22527720)
Natural Nylon

Hood Seal Retainer
GM 1981-On

UNIT PACKAGE: 25

Sec. 19

TRIMMING SUNDRIES & FASTENERS

Refer to Retainer Specification Chart on pages 475-489

Roof Trim & Garnish Retainer
Ford Explorer 1992-On



19352

(N807155-S)
Medium Mist Gray

UNIT PACKAGE: 25

19354

(N807155-S)
Medium Camel Tan

UNIT PACKAGE: 25



19855

(4717224)
Black Nylon

Trim Panel Retainer
Chrysler Concorde, Intrepid, LHS,
New Yorker, Vans & Vision 1993 - On

UNIT PACKAGE: 50



10831

(GM: 332364, 14093311, 20732399;
Ford: 389358, W701259-S300;
Chry: 3691590, 6031321, 6505411-AA,
AMC: 4004569)
Black Nylon

Fender & Bumper Shield Retainer
GM, Ford, Chrysler & AMC

UNIT PACKAGE: 50

16259

Same as 10831 except for unit package quantity

UNIT PACKAGE: 100



10832

(GM: 6270163;
Chry: 6030538)
Gray Nylon

Fender & Bumper Shield Retainer
GM 1973 - On
Chrysler

UNIT PACKAGE: 50



15664

White Nylon

Fender & Bumper Shield Retainer
White version of Auveco 10831
GM, Ford, Chrysler & AMC

UNIT PACKAGE: 100



11146

(GM: 11569768, 15958694, 1605396;
Chry: 6030441;
Ford: 388577S, W705589-S300)
Black Nylon

Radiator Yoke, Fender &
Bumper Shield Retainer
GM, Ford & Chrysler

UNIT PACKAGE: 25

15414

Same as 11146 except for unit package quantity

UNIT PACKAGE: 100



19790

(Not Available from O.E.M.)
Gray Nylon

Trim Panel Retainer
Gray version of Auveco 11146
GM, Ford & Chrysler

UNIT PACKAGE: 50



19250

(Not Supplied by O.E.M.)
White Nylon

Trim Panel Retainer
White version of Auveco 11146

UNIT PACKAGE: 25



21756

(Not Available from O.E.M.)
Clear Nylon

Trim Panel Retainer
Clear version of Auveco 11146
Universal

UNIT PACKAGE: 50



17664

(GM: 10121502; Chry: 6033082,
6033840; Ford: 390018-S)
Black Nylon

Shield Retainer
Battery Post Cable Shield,
Engine Splash Shield
Radiator Side Air Baffle
GM 1989-On

UNIT PACKAGE: 50

TRIMMING SUNDRIES & FASTENERS

Refer to Retainer Specification Chart on pages 475-489



17612

(Chry: 6504043; Ford: N807721-S)
Black Nylon

Trim Panel Retainer
Ford Explorer 1993 - On
Trunk Lid Latch
Chrysler 1996 - On

UNIT PACKAGE: 50

Trim Panel Retainer Ford Explorer, Mountaineer,
Windstar & Ranger 1991-On



21026

(4860379-AA)
Black Nylon

Door Trim Panel Retainer
Dodge 300 Series, Magnum
& Charger 2005 - On

UNIT PACKAGE: 25



19371

(N807154-S)
Dark Denim (Blue) Nylon

UNIT PACKAGE: 50



16132
Black Nylon

Trim Panel Retainer
Universal

UNIT PACKAGE: 25



19373

(N807154-S)
Zuca Granite (Light Gray)
Nylon

UNIT PACKAGE: 50



15543

(GM: 22547243, 11610086,
Chry: 6501916)
Black Nylon

Splash Shield &
Wheel Well Cover Retainer
Chrysler 1988 - On
Hood Seal Retainer
GM 1989 - On

UNIT PACKAGE: 50



19374

(N807154-S)
Medium Prairie Tan Nylon

UNIT PACKAGE: 50



20878

(90467-A0008)
Black Nylon

Bumper Cover Retainer
Toyota, Lexus & Scion 1995 - On

UNIT PACKAGE: 50



21392

(1H0-819-055-B01C)
Black Nylon

Instrumental Panel, Cowl Vent,
Defroster Grille & Ducts Retainer
Phillips Drive
Audi and Volkswagen Cabrio,
Golf & Jetta 2002 - 1993

UNIT PACKAGE: 25



16775

(Honda: 90667-SA7-0030;
Nissan: 89427-98070)
Black Nylon

Trim Panel Retainer
Honda & Nissan

UNIT PACKAGE: 25



21257

(Chry: 6508727-AA;
Ford: W706815-S300)
Black Nylon

Trunk Trim and Insulator Retainer
Ford Focus, Fusion, Milan,
MKZ & Zephyr 2006 - On

UNIT PACKAGE: 25



19121

(90467-08104)
Gray Nylon

Roof Headliner Retainer
Toyota MR2 1990 - On

UNIT PACKAGE: 15

Sec. 19

TRIMMING SUNDRIES & FASTENERS

Refer to Retainer Specification Chart on pages 475-489



21906
(Renault & Dacia: 77-03-077-090)
Black Nylon

Trim Panel Retainer
Renault & Dacia

UNIT PACKAGE: 10



18685
(3548804)
Black Nylon

License Plate Bracket &
Bumper Fascia Retainer
Cadillac Eldorado & Seville 1995 - On

UNIT PACKAGE: 25



21868
(Peugeot & Citroen: 6999.R1;
Renault & Dacia: 77-03-077-174)
Black Nylon

Trim Panel Retainer
Peugeot, Citroen,
Renault & Dacia

UNIT PACKAGE: 25



20189
(GM: 16674629;
Ford: N806113-S; Chry: 6503943)
Black Nylon

Trim Panel Retainer
Cadillac Concours, DeVille & Seville;
Chevrolet Impala, Lumina & Monte Carlo;
Dodge Ram & Dakota; Ford and Pontiac
Grand Prix 1995 - On

UNIT PACKAGE: 50



17076
(GM: 94145515;
Isuzu: 8941455150)
Black Nylon

Inner Fender Shield &
Bumper Fascia Retainer
Geo Storm & Isuzu 1990 - On

UNIT PACKAGE: 25



21905
(Renault & Dacia: 82-00-721-200)
Gray Nylon

Trim Panel Retainer
Renault & Dacia

UNIT PACKAGE: 25



19834
(15975244)
Black Nylon

Wiring Harness &
Headliner Retainer
Engine Wiring Harness,
Tailgate, Headliner & Air Cleaner
GM C, E, K, S & T Trucks 1994 - On

UNIT PACKAGE: 50



20319
(W700671-S300)
Black Nylon

Hood Insulation Retainer
Ford Contour & Mystique 1995 - On

UNIT PACKAGE: 25



21900
(Renault & Dacia: 77-03-077-453)
Black Nylon

Trim Panel Retainer
Renault & Dacia

UNIT PACKAGE: 15



19837
(Not Available from O.E.M.)
Black Nylon

Trim Panel Retainer
Chrysler

UNIT PACKAGE: 50



20360
(GM: 22189414;
Chry: 6505667-AA)
Black Nylon

Engine Compartment &
Front End Retainer
Buick LeSabre, Park Ave.,
Rendezvous, & Riviera;
Cadillac DeVille & Seville;
Chevrolet Venture, Oldsmobile
Silhouette and Pontiac Aztek,
Bonneville & Montana 2000 - On
Chrysler 2010 - On

UNIT PACKAGE: 25



19127
(N808370-S)
Black Nylon

Carpet Retainer
Ford Taurus & Sable 1996 - On

UNIT PACKAGE: 25

TRIMMING SUNDRIES & FASTENERS

Refer to Retainer Specification Chart on pages 475-489



21248
(15944588)
Tan Nylon

Headliner Retainer
Chevrolet Malibu 2004 - On
UNIT PACKAGE: 25



19760
(N807535-S)
Black Nylon

Kick Plate Retainer
Ford Ranger 1993 - On
UNIT PACKAGE: 50



21301
(11610747)
Black Nylon

Grille Retainer
Use with Auveco 21302
Cadillac SRS & SRX and Chevrolet
Camaro 2010 - On
UNIT PACKAGE: 25



21338
(15802005)
Black Nylon

Fender & Headliner Retainer
GM Acadia, Camaro, Enclave, Traverse,
& Saturn Outlook 2008 - On
UNIT PACKAGE: 25



15523
(E9SB-6302354-ACW)
Black Nylon

Cowl Side Trim Retainer
Ford T-Bird & Cougar
1989 - On
UNIT PACKAGE: 25



19541
(6504135)
Black Nylon

Hood Insulation Retainer
Chrysler Mini-Vans & Durango 1997 - On
UNIT PACKAGE: 50



21691
(Suzuki: 09409-06309-5ES)
Black Nylon

Hood Insulation
Retainer
Grand Vitara, Swift &
XL7 1990 - On
UNIT PACKAGE: 25



10332
(2998430)
Black Nylon

Radiator Grille Retainer
Chrysler
UNIT PACKAGE: 25



21090
(24501057)
Black Nylon

Fender Apron &
Radiator Baffle Retainer
Cadillac Escalade,
Chevrolet Denali & Tahoe,
GMC Yukon and
Hummer H3 2006 - On
UNIT PACKAGE: 25



15481
(6501067)
Black Nylon

Fascia Retainer
Chrysler 1985-On
UNIT PACKAGE: 50



21809
(Peugeot & Citroen: 6983.17)
Black Nylon

Retainer
Peugeot & Citroen
UNIT PACKAGE: 25

Sec. 19

TRIMMING SUNDRIES & FASTENERS

Refer to Retainer Specification Chart on pages 475-489



15480

(Ford: N802734S; GM: 22718305)
Black Nylon

Trim Panel & Hood
Insulation Retainer
Ford 1983 - On
GM 1997 - On

UNIT PACKAGE: 50

19197

(N802734-S)
Medium Opal (Gray) Nylon

UNIT PACKAGE: 50



21907

(Renault & Dacia: 82-00-321-368)
Gray Nylon

Trim Panel Retainer
Renault & Dacia

UNIT PACKAGE: 10



12571

(389443-S)
Black Nylon

Fascia to Bumper Retainer
Ford 1981 - On

UNIT PACKAGE: 25



12731

(20319841)
Black Nylon

Seat Back Retainer
GM Camaro & Firebird 1982 - On

UNIT PACKAGE: 25



21805

(Renault: 77-03-077-435)
Black Nylon

Retainer
Renault and Dacia

UNIT PACKAGE: 25



20281

(11518201)
Black Nylon

Bumper Fascia Retainer
Pontiac Grand Am 1999 - On

UNIT PACKAGE: 15



21806

(Renault: 77-03-077-225)
Black Nylon

Retainer
Renault and Dacia

UNIT PACKAGE: 25



11673

(GM: 2048248; Chry: 6003423)
Natural Nylon

Interior Trim Panel Retainer
GM & Chrysler 1977 - On

UNIT PACKAGE: 50



21914

(Renault & Dacia:
77-03-074-315)
Black Nylon

Trim Panel Retainer
Head Diameter: 40mm
Stem Diameter: 10.5mm
Stem Length: 26mm
Renault & Dacia

UNIT PACKAGE: 10



11351

(Ford: 385661-S;
Chry: 6032363; VW: N989022)
Black Nylon

Door Trim Panel Retainer
Ford, Chrysler & VW 1975 - On

UNIT PACKAGE: 25

Email your product suggestions to

mail@auveco.com

TRIMMING SUNDRIES & FASTENERS

Refer to Retainer Specification Chart on pages 475-489



20316

(Ford: 388904-S;
Chry: 4381395, 6501086)
Black Nylon

Door Frame Spacer Retainer
Replaces Auveco 14042
Chrysler 1985 - On
Bumper Retainer
Ford 1981 - On

UNIT PACKAGE: 50



20262

(22642756)
Black Nylon

Trunk Trim Retainer
Chevrolet Cavalier &
Pontiac Sunfire 1995 - On

UNIT PACKAGE: 25



20362

(15056810)
Black Nylon

Bumper Fascia Retainer
GM S & T Trucks 2002 - On

UNIT PACKAGE: 25



21789

(VW: 1H0-867-199-01C)
Black Nylon

Radiator Grille, Scuff Plate,
Sill & Trim Panel Retainer
Volkswagen & Audi 1997 - On

UNIT PACKAGE: 25



12766

(22512276)
Black Nylon

Front End Stone Shield Retainer
GM 1981 - On

UNIT PACKAGE: 25

16262

Same as 12766 except for unit package quantity

UNIT PACKAGE: 50



12137

(1619321)
Black Nylon

Radiator Apron Panel Retainer
GM 1977 - On

UNIT PACKAGE: 25

16263

Same as 12137 except for unit package quantity

UNIT PACKAGE: 50



18679

(20652520)
Gray Nylon

Compensator Panel to
Quarter Panel Retainer
Buick Century & Skylark, Cadillac
Fleetwood and Olds Calais 1992 - 83

UNIT PACKAGE: 25



15478

(GM: 1631564;
Ford: N804379S, W706358-S300)
Black Nylon

Bumper Fascia Retainer
Buick, Cadillac & Olds 1981 - On
Taurus & Sable 1986 - On

UNIT PACKAGE: 50



18771

(6502104)
Black Nylon

Headlight Mounting Panel to Cross
Member Sight Shield Retainer
Dodge Daytona 1993

UNIT PACKAGE: 25



18680

(10229437, 10242316)
Black Nylon

Headliner Trim Finish Panel Retainer
Buick Skylark, Chevrolet Camaro,
Cavalier, Lumina & Monte Carlo,
Oldsmobile Cutlass and Pontiac Firebird,
Grand Am, Grand Prix & Sunfire 1992 - On

UNIT PACKAGE: 25

Sec. 19

TRIMMING SUNDRIES & FASTENERS

Refer to Retainer Specification Chart on pages 475-489



19501
(10249241)
Tan Nylon

Headliner Trim Panel Retainer
Buick Century, Regal & Skylark;
Chevrolet Camaro, Cavalier, Lumina,
Monte Carlo & Venture; Oldsmobile
Silhouette and Pontiac Firebird,
Grand Am, Sunfire &
Trans Sport 1995 - On

UNIT PACKAGE: 25



18688
(10220168, 10241518)
Gray Nylon

Headliner Trim Finish Panel Retainer
Buick Century & Regal, Chevrolet
Caprice, Camaro, Lumina & Monte Carlo,
Olds Cutlass Ciera and Pontiac Firebird &
Grand Prix 1992 - On

UNIT PACKAGE: 50



20345
(15006827)
Gray Nylon

Headliner Retainer
GM C & K Trucks 2000 - On

UNIT PACKAGE: 25



22338
(VW: 3C0-863-559)
Black Nylon

Wheel House Cover Mount &
Interior Trim Retainer
Volkswagen Passat &
CC 2012 - 2006

UNIT PACKAGE: 25



20625
(Ford: XW7Z-6302354-AAB)
Tan Nylon

Headliner Retainer
Ford Expedition & Navigator
2003 - On

UNIT PACKAGE: 25



12759
(14027471)
Black Nylon

Trim Panel Retainer
GM Trucks 1981 - On

UNIT PACKAGE: 25



12909
(388930-S)
Black Nylon

Trim Panel Retainer
Ford 1980 - On

UNIT PACKAGE: 50



20874
(90467-07049-CO)
Black Nylon

Trim Panel Retainer
Lexus 2000 - On

UNIT PACKAGE: 25

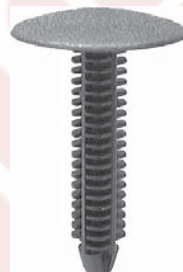

15479
(N804349S)
Black Nylon

Interior Trim Retainer
Ford 1986-On

UNIT PACKAGE: 25



21241
(W706635-SSW)
Black Nylon

Rocker, Pillar &
Fender Liner Retainer
Ford Fusion & Taurus 2009 - On

UNIT PACKAGE: 50



22053
(Ford: W715951-S300)
Black Nylon

Rear Body &
Interior Trim Retainer
Ford Escape 2013 - On

UNIT PACKAGE: 15

TRIMMING SUNDRIES & FASTENERS

Refer to Retainer Specification Chart on pages 475-489



Trim & Garnish Retainer
Ford Vans 1992 - On

19845

(E8FZ-5802354A)
Medium Graphite Nylon

UNIT PACKAGE: 25

19846

(F2UZ-1602354AAA)
Black Nylon

UNIT PACKAGE: 25



18277
(N806344-S)
Gray

Roof Trim Panel &
Garnish Moulding Retainers
Ford Ranger 1992-On

UNIT PACKAGE: 25



21228
(10444839)
Tan Nylon

Headliner Retainer
Chevrolet Express Van &
GMC Savana Van 2004 - On

UNIT PACKAGE: 25

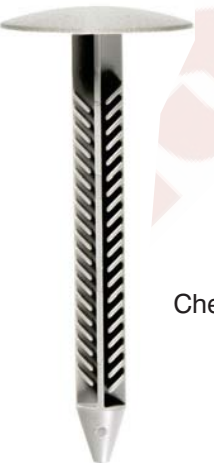

21287
(25822063)
Opal Gray Nylon

Headliner Retainer
Chevrolet Silverado Hybrid 2010 - On

UNIT PACKAGE: 25



21288
(65846-4Z000)
Black Nylon

Hood Insulation Retainer
Nissan Altima 2010 - On

UNIT PACKAGE: 15



19468
(65846-40F00)
Black Nylon

Hood Insulation Retainer
Infiniti J30, M30 & Q45 1989 - On

UNIT PACKAGE: 15



21380
(15989431)
Black Nylon

Hood Insulation Retainer
Chevrolet Traverse 2010 - On

UNIT PACKAGE: 25



22211
(Subaru: 909207031)
Black Nylon

Hood Insulation Retainer
Subaru BRZ, Forester, Impreza,
WRX & XV Crosstrek 2012 - On

UNIT PACKAGE: 50



15998
(90700-SB2-003)
Black Nylon

Hood Insulation Retainer
Honda Prelude 1985 - On

UNIT PACKAGE: 15



21421
(909130074)
Black Nylon

Hood Insulation Retainer
Subaru Baja, Forester, Impreza,
Legacy, Outback & Tribeca 1998 - On

UNIT PACKAGE: 15



21443
(11571159)
Black Nylon

Hood Insulation Retainer
Chevrolet Cruze 2011 - On

UNIT PACKAGE: 25

Sec. 19

TRIMMING SUNDRIES & FASTENERS

Refer to Retainer Specification Chart on pages 475-489



21313
(W708633-S300)
Black Nylon

Hood Insulation Retainer
Ford Fusion 2010 - On

UNIT PACKAGE: 25



20615
(11517992)
Black Nylon

Fender Liner Retainer
Pontiac Bonneville 2000 - On

UNIT PACKAGE: 25



11842
(N-800387-S)
Black Nylon

Dashboard Retainer
Ford 1979 - On

UNIT PACKAGE: 25

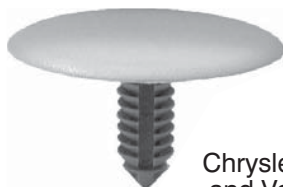

20541
(TY98TL2-AA)
Tan Nylon

Headliner Retainer
Chrysler Caravan, Town & Country
and Voyager Mini-Vans 2001 - On

UNIT PACKAGE: 25



11350
(4005250)
White Nylon

Door Panel Retainer
American Motors 1976 - On

UNIT PACKAGE: 25



15457
(20030401)
Black Polypropylene

Hood Insulation Retainer
GM 1980 - On

UNIT PACKAGE: 25



17381
(N805315)
Gray Nylon

Headliner Retainer
Ford Aerostar 1986 - On

UNIT PACKAGE: 10



21385
(89026634)
Light Gray Nylon

Headliner Retainer
Chevrolet Impala 2010 - On

UNIT PACKAGE: 25



19338
(Chry: 6504098;
Ford: N808842-S)
Black Nylon

Hood Insulation Retainer
Chrysler Sebring 1996 - On
Ford Taurus, Sable & Mark VIII 1996 - On

UNIT PACKAGE: 50



21386
(89026635)
Tan Nylon

Headliner Retainer
Chevrolet Impala 2010 - On

UNIT PACKAGE: 25



22233
(GM: 11611677)
Black Nylon

Hood Insulation Retainer
Cadillac ELR, Chevrolet Colorado &
Volt and GMC Canyon 2011 - On

UNIT PACKAGE: 10

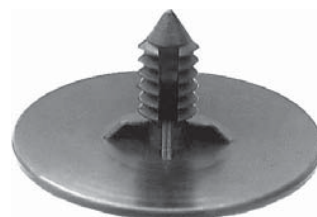

15456
(20064875)
Black Nylon

Hood Insulation Retainer
GM 1980 - On

UNIT PACKAGE: 25

TRIMMING SUNDRIES & FASTENERS

Sec. 19

Refer to Retainer Specification Chart on pages 475-489



11130
(3078511, 3977775)
Black Nylon

Hood Insulation Retainer
GM 1964 - On

UNIT PACKAGE: 25



16863
(N803613S)
Black Nylon

Hood Insulation Retainer
Ford Bronco, Explorer &
Ranger 1988 - On

UNIT PACKAGE: 25



15668
(N803387)
Black Nylon

Trim Panel Retainer
Ford

UNIT PACKAGE: 25



17215
(21039141)
Black Nylon

Hood Insulation Retainer
GM Saturn 1991 - On

UNIT PACKAGE: 25



21227
(25749564)
Tan Nylon

Headliner Retainer
Chevrolet Express Van
& GMC Savana Van 2004 - On

UNIT PACKAGE: 15



21891
(VW: N905-333-01)
Black Nylon

Hood Insulation Retainer
VW, Audi, SEAT & Skoda

UNIT PACKAGE: 15



18827
(6503892)
Black Nylon

Hood Insulation Retainer
Chrysler Cirrus & Stratus 1995 - On

UNIT PACKAGE: 50



19655
(386553-S)
Black Nylon

Hood Insulation Retainer
Replaces Auveco 13571
Ford 1975 - On

UNIT PACKAGE: 25

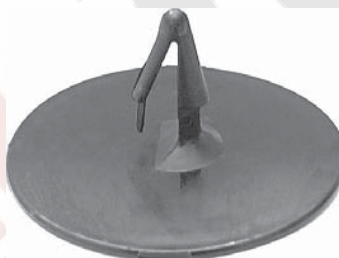

14163
(388908-S)
Black Nylon

Hood Insulation Retainer
Ford 1975- On

UNIT PACKAGE: 50



17975
(Chry: 6502842,
GM: 21039129)
Black Nylon

Hood Insulation Retainer
Chrysler Concorde, Dodge Intrepid
& Eagle Vision 1993 - On
GM Corvette, Equinox & Saturn 1992 - On

UNIT PACKAGE: 50



21211
(53326-08010)
Black Nylon

Hood Insulation Retaining Clip
Toyota Sienna 2009 - On

UNIT PACKAGE: 25



20164
(4878883AA)
Black Nylon

Hood Insulation Retainer
Chrysler LH & LHS Series 1997 - On

UNIT PACKAGE: 50

Sec. 19

TRIMMING SUNDRIES & FASTENERS

Refer to Retainer Specification Chart on pages 475-489



21652

(91501-SWA-003)
Black Nylon

Hood Insulation Retainer
Honda Civic 2012 - On

UNIT PACKAGE: 25



22168

(GM: 13265959)
Black Nylon

Hood Insulation Retainer
Cadillac Catera 2001 - 1997 &
Buick Regal 2011 - On

UNIT PACKAGE: 25



17004

(4341060)
Black Nylon

Hood Insulation &
Fender Shield Retainer
Chrysler 1985- On

UNIT PACKAGE: 25



22103

(Toyota: 53857-47011)
Black Nylon

Front Fender Retainer with Sealer
Lexus CT 200h and Toyota Camry, Prius,
RAV4, Yaris & 4-Runner 2010 - On

UNIT PACKAGE: 15



19155

(4428987)
Black Nylon

Hood Insulation Retainer
Dodge Ram 1994 - On

UNIT PACKAGE: 25



13467

(GM: 7642589;
AMC: 4001934)
Black Nylon

Firewall Insulation Retainer
GM & AMC

UNIT PACKAGE: 25



17237

(Nissan: 65832-F5000
65846-30F00)
Black Nylon

Hood Insulation Retainer
Mercury Villager 1999 - On
Nissan 1981 - On

UNIT PACKAGE: 15



21776

(BMW: 51-77-7-171-003)
Black Nylon

Rocker Panel & Wheel Housing
Retainer with Rubber O-Ring
X Series 2006 - On

UNIT PACKAGE: 25



18746

(90700-SJ4-000)
Black Nylon

Hood Insulation Retainer
Head Diameter: 30mm
Stem Diameter: 15mm x 18mm
Stem Length: 6mm
Acura Legend 1991 - On
Honda 1998 - On

UNIT PACKAGE: 15



13757

(389809)
Black Nylon

Hood Insulation Retainer
2" Square
GM 1980 - On

UNIT PACKAGE: 25



20609

(91501-S1K-003, 91501-STK-003)
Black Nylon

Hood Insulation Retainer
Acura 3.5RL & RSX and
Honda Civic & CR-V 2000 - On

UNIT PACKAGE: 25

TRIMMING SUNDRIES & FASTENERS

Refer to Retainer Specification Chart on pages 475-489



17072
(15659161)
Black Nylon

Front Door
Frame Hole Plug
GM Blazer, Jimmy &
Pickup 1989 - On

UNIT PACKAGE: 25



14985
(2664040)
White Nylon

Door Weatherstrip Retainer
Chrysler 1966 - On

UNIT PACKAGE: 100



21982
(VW: 251-823-717)
Black Nylon

Weatherstrip Retainer
VW, Audi, SEAT & Skoda

UNIT PACKAGE: 25



21981
(VW: 1H0-823-717)
Black Nylon

Weatherstrip Retainer
VW, Audi, SEAT & Skoda

UNIT PACKAGE: 25



14299
(73862-672-003)
White Nylon

Weatherstrip Retainer
Honda

UNIT PACKAGE: 50



20182
(Not Available from O.E.M.)
White Nylon

Weatherstrip Retainer
Chrysler LH & LHS Series 1997 - On

UNIT PACKAGE: 100



18510
(20200750)
Natural Nylon

Hood Seal Retainer
Buick, Cadillac, Chevrolet,
GMC & Oldsmobile 1970 - On

UNIT PACKAGE: 100



22321
(Hyundai: 86438-2T000)
Black Nylon

Hood & Bumper Seal Retainer
Hyundai Elantra &
Genesis 2013 - On
Kia K900 & Optima 2011 - On

UNIT PACKAGE: 50



21382
(86434-4A000)
Black Nylon

Hood Seal Retainer
Hyundai Elantra, Sonata & Tucson
and Kia Sportage 2009 - On

UNIT PACKAGE: 50



22320
(Hyundai: 86438-1R000)
Black Nylon

Hood Seal Retainer
Hyundai Accent 2011 - On

UNIT PACKAGE: 50



22107
(Nissan: 80850-JM01A)
Black Nylon

Weatherstrip Retainer
Nissan Rogue 2008 - On

UNIT PACKAGE: 25



14328
(90664-671-003, 91530-SE0-003)
White Nylon

Weatherstrip Retainer
Honda

UNIT PACKAGE: 50

Sec. 19

TRIMMING SUNDRIES & FASTENERS

Refer to Retainer Specification Chart on pages 475-489



20180

(Not Available from O.E.M.)
Black Nylon

Weatherstrip Retainer
Chrysler LH & LHS Series 1997 - On

UNIT PACKAGE: 100



8853

(C5AB-6220586A)
Natural Nylon

Door Weatherstrip Retainer
Ford

UNIT PACKAGE: 50



10744

(4876498)
Black Nylon

Weatherstrip Retainer
GM

UNIT PACKAGE: 100



21143

(51-71-1-496-621)
Black Nylon

Rocker Moulding Retainer
Mini-Cooper 2002 - On

UNIT PACKAGE: 25



19678

(Not Available from O.E.M.)
White Nylon

Weatherstrip Retainer
Ford Windstar 1995 - On

UNIT PACKAGE: 50



19449

(10403591)
Black Nylon

Rear Bumper Fascia Retainer
Oldsmobile Intrigue &
Pontiac Grand Prix 1998 - On

UNIT PACKAGE: 25



18509

(4040732)
Black Nylon

Weatherstrip Retainer Hood Inner
Panel to Cowl & Door Weatherstrip
Dodge F.W.D. Pick-Up 1989 - 82

UNIT PACKAGE: 100



22310

(Mercedes: 001-988-97-81)
White Nylon

Scuff Plate Retainer
Mercedes-Benz C230, C280, C350,
C55, CLK350, CLK500, CLK55, CLK63,
S350 & S430 2009 - 2006

UNIT PACKAGE: 25



21381

(86438-4A100)
Black Nylon

Hood Seal Retainer
Hyundai Elantra & Tucson and
Kia Forte & Sportage 2009 - On

UNIT PACKAGE: 50



19418

(GM: 480534;
Ford: 384051-S)
Black Nylon

Cowl Insulation Retainer
GM
Splash Shield and Wire Retainer
Ford

UNIT PACKAGE: 25



19425

(385677)
Natural Nylon

Weatherstrip Retainer
Ford

UNIT PACKAGE: 50



21125

(Not Available from O.E.M.)
Black Nylon

Front Bumper Retainer
Cadillac STS 2005 - On

UNIT PACKAGE: 15

TRIMMING SUNDRIES & FASTENERS

Refer to Retainer Specification Chart on pages 475-489



21694

(Lexus: 67867-50020)
Black Nylon

Weatherstrip Retaining Clip
Lexus GS 300 &
LS 400 2005 - 1990

UNIT PACKAGE: 25



19325

(MU481027)
Brown Nylon

Hood Weatherstrip Retainer
Mitsubishi Eclipse & Diamante 1991 - On

UNIT PACKAGE: 25



21552

(90467-04034)
White Nylon

Weatherstrip Retainer
Lexus CT 200h, HS 250h, IS F, IS 250, IS 350, LS 460,
LS 600h, RX 350, RX 400h & RX 450h and Toyota
Avalon, Corolla, Highlander, Matrix, Prius,
RAV-4, Scion & Venza 2003 - On

UNIT PACKAGE: 25



20760

(Not Available from O.E.M.)
Natural Nylon

Weatherstrip Retainer
Chrysler 300 & Dodge Magnum 2005 - On

UNIT PACKAGE: 100



19850

(N806340-S)
Natural Nylon

Weatherstrip Retainer
Ford F150 1999 - On

UNIT PACKAGE: 100



21565

(90331AA050)
White Nylon

Weatherstrip Retaining Clip
Subaru Forester 2008 - 03

UNIT PACKAGE: 25



21334

(W711858-S300)
White Nylon

Weatherstrip Retainer
Ford Edge & MKX 2007 - On

UNIT PACKAGE: 100



22162

(Not Available From O.E.M.)
Orange Nylon

Weatherstrip Retainer
Ford Explorer 2014 - On

UNIT PACKAGE: 100



19481

(GA2A-58-762)
Blue Nylon

Front & Rear Door
and Hood Weatherstrip
Mazda 626 & Millenia 1995 - On

UNIT PACKAGE: 50



22355

(Not Available From O.E.M.)
Green Nylon

Fender Seal &
Weatherstrip Retainer
Overall Height: 13.5mm
Ford Mustang 2015 - On

UNIT PACKAGE: 50



22356

(Not Available From O.E.M.)
Pink Nylon

Fender Seal &
Weatherstrip Retainer
Overall Height: 13.5mm
Ford Mustang 2015 - On

UNIT PACKAGE: 50



20181

(Not Available from O.E.M.)
White Nylon

Weatherstrip Retainer
Chrysler LH &
LHS Series 1997 - On

UNIT PACKAGE: 100



19368

(10283414, 10405030)
Natural Nylon

Door Weatherstrip Retainer
Buick Century & Regal and
Oldsmobile Intrigue 1997 - On

UNIT PACKAGE: 100

Sec. 19

TRIMMING SUNDRIES & FASTENERS

Refer to Retainer Specification Chart on pages 475-489



21980

(VW: 1Z0-837-732A)
Yellow Nylon

Weatherstrip Retainer
VW, Audi, SEAT & Skoda

UNIT PACKAGE: 25



22325

(Hyundai: 87756-2W000)
Red Nylon

Weatherstrip Retainer
Hyundai Santa Fe &
Kia Sorento 2013 - On

UNIT PACKAGE: 100



22302

(Not Available from O.E.M.)
Yellow Nylon

Weatherstrip Retainer
Overall Height: 12.5mm
Ford F-150 & Super Duty Trucks and
Lincoln Mark LT 2003 - On

UNIT PACKAGE: 50



20831

(Not Available from O.E.M.)
Blue Nylon

Weatherstrip Retainer
Ford Explorer 2005 - On

UNIT PACKAGE: 100



22060

(Nissan: 65810-K2002)
Black Nylon

Hood Seal Retaining Clip
Infiniti 2003 - 1997
Nissan 2003 - 1996

UNIT PACKAGE: 25



18692

(Ford: E7GZ-6120586-B;
Hyundai: 86438-2B000;
Mazda: G031-58-762;
Toyota: 67868-89101,
67867-28030, 67867-89103)
Natural Nylon

Weatherstrip Retainer
Toyota 4-Runner 1989-83
Mazda 1996 - On; Ford 1996 - On
Hyundai 2007- On; Kia 2009 - On

UNIT PACKAGE: 50



21229

(65810-K2000)
Black Nylon

Hood Seal Retaining Clip
Infiniti 130, 135, Q45 &
QX4 and Nissan Maxima &
Pathfinder 2004 - 1996

UNIT PACKAGE: 25



19171

(91568-SR2-003)
Green Nylon

Weatherstrip Retainer
Honda Odyssey 1995 - On

UNIT PACKAGE: 100



19749

(67867-12150)
White Nylon

Weatherstrip Retainer
Toyota Avalon 1995 - On

UNIT PACKAGE: 15



20443

(67867-0C010)
Black Nylon

Weatherstrip Retainer
Toyota Tundra 1999 - On

UNIT PACKAGE: 25

**Please place orders in
Unit Package quantities,
not based on pieces needed**

TRIMMING SUNDRIES & FASTENERS

Refer to Retainer Specification Chart on pages 475-489



21773

(Honda: 91530-S0A-003)
Black Nylon

Roof Rail & Side Sill
Weatherstrip Retainer
Acura Legend, MDX, RDX, RL,
TL & ZDX 1998 - On
Honda Accord, Civic, CRV, Element
& Odyssey 2001 - On

UNIT PACKAGE: 25



21705

(Honda: 90651-TP8-003,
91568-TR0-003)
Yellow Nylon

Weatherstrip Retainer
Acura ILX & RDX and
Honda Civic & CR-V 2012 - On

UNIT PACKAGE: 25



21707

(Honda: 91563-SCV-003)
(Toyota: 67867-52010,
67867-0D060)
White Nylon

Weatherstrip Retainer
Acura TL and Honda Element
Odyssey & Pilot 2003 - On
Toyota Echo, Land Cruiser,
Prius, Tacoma & Yaris and
Lexus GS 450, GX 460 & LX 430
and Scion xA & xD 2000 - On

UNIT PACKAGE: 25



21704

(Honda: 72311-S5S-003)
Green Nylon

Weatherstrip Retaining Clip
Acura RDX and Honda Civic,
CR-V & Fit 2003 - On

UNIT PACKAGE: 25



18877

(91530-SP1-003)
Nylon

Weatherstrip Retainer
Acura 3.5 RL & Honda Accord,
Civic, & Odyssey 1992 - On

UNIT PACKAGE: 25



22337

(Hyundai: 82132-27100)
White Nylon

Door Weatherstrip Retainer
Hyundai Azera, Santa Fe &
Sonata 2001 - On

UNIT PACKAGE: 25



19116

(91530-ST5-003)
Natural Nylon

Weatherstrip Retainer
Honda Civic 1995 - On

UNIT PACKAGE: 10



17339

(N806289-S)
Black Nylon

Weatherstrip Retainer
Lincoln 1989 - On

UNIT PACKAGE: 50



19684

(01553-09311)
Blue Nylon

Weatherstrip Retainer
Nissan Altima & Sentra 1994 - On

UNIT PACKAGE: 25



21949

Black Nylon

Weatherstrip Retainer
Peugeot & Citroen

UNIT PACKAGE: 25



18033

(Chry: 4696129;
GM: 21077575)
White Nylon

Weatherstrip Retainer
Chrysler Concorde & LHS
Dodge Intrepid & Eagle Vision 1993 - On
Oldsmobile Alero &
Pontiac Grand Am 1999 - On

UNIT PACKAGE: 50

Sec. 19

TRIMMING SUNDRIES & FASTENERS

Refer to Retainer Specification Chart on pages 475-489



21633
(80850-89900)
White Nylon

Weatherstrip Retainer
Infiniti 130, 135 & M45 and
Nissan Maxima 2004 - 2000

UNIT PACKAGE: 25



19683
(91502-S84-A11)
Black Nylon

Cowl Vent Retaining Clip
Honda Odyssey 1999 - On

UNIT PACKAGE: 15



17991
(90467-06092)
Black Nylon

Retaining Clip
Lexus 1990 - On

UNIT PACKAGE: 10



18330
(94848189, 94848192)
White Nylon

Front Door Weatherstrip Retainer
Geo Prizm 1992 - 89

UNIT PACKAGE: 25



19728
(90467-10146)
Black Nylon

Cowl Panel Retainer
Toyota Sienna Van 1997 - On

UNIT PACKAGE: 25



19724
(65810-K2009)
White Nylon

Hood to Cowl Seal Retainer
Infiniti & Nissan Pathfinder 1992 - On

UNIT PACKAGE: 25



19483
(91515-SR3-000)
Black Nylon

Rear Hood Cowl
Weatherstrip Retaining Clip
Acura Integra, Honda Civic, CR-V
& Del Sol 1992 - On

UNIT PACKAGE: 25



19720
(90467-06138)
Black & White Nylon

Hood to Cowl Seal Retainer
Toyota Avalon & Camry 1994 - On

UNIT PACKAGE: 10



18508
(4001916)
Black Nylon

Weatherstrip Retainer
Jeep Wrangler 1991 - On

UNIT PACKAGE: 50



11136
(Ford: 385330-S,
D30Z-16776-A;
Chry: 6003351)
Black Nylon

Hood Insulation Retainer
Chrysler 1972 - On
Grille to Radiator Retainer
Ford 1973 - On

UNIT PACKAGE: 25



18166
(80875-85E00)
Black Nylon

Trim Panel Retainer
Nissan Maxima 1989 - On

UNIT PACKAGE: 25



18818
(91513-SE0-003)
Natural Nylon

Hood Seal Retainer
Honda Accord & Prelude 1983 - On

UNIT PACKAGE: 25



21919
Black Nylon

Weatherstrip Retaining Clip
Peugeot, Citroen, Renault & Dacia

UNIT PACKAGE: 25

TRIMMING SUNDRIES & FASTENERS

Refer to Retainer Specification Chart on pages 475-489



21918

(Peugeot & Citroen: 9025.J8)
Black Nylon

Weatherstrip Retaining Clip
Peugeot, Citroen, Renault & Dacia

UNIT PACKAGE: 25



21920

Black Nylon

Weatherstrip Retaining Clip
Peugeot, Citroen, Renault & Dacia

UNIT PACKAGE: 25



21295

(01553-08961)
Black Nylon

Weatherstrip Retaining Clip
Nissan Altima 2009 - On

UNIT PACKAGE: 25



3639

(C1AB-6220807-A)
White Nylon

Door Flange Weatherstrip Retainer
Ford

UNIT PACKAGE: 100



3620

(4801268)
Black Nylon

Door Flange Weatherstrip Retainer
GM

UNIT PACKAGE: 100



18248

(55055098)
Black Nylon

Headlight Grille Retaining Clip
Dodge Ram 1994 - On

UNIT PACKAGE: 25



21573

(90331GA090)
Black Nylon

Weatherstrip Retaining Clip
Subaru Forester & Legacy 2008 - 1990

UNIT PACKAGE: 25



21942

(Peugeot & Citroen: 6983.24)
Black Nylon

Trim Retaining Clip
Peugeot & Citroen

UNIT PACKAGE: 25



21943

(Peugeot & Citroen: 8749.Q5)
Gray Nylon

Trim Retaining Clip
Peugeot & Citroen

UNIT PACKAGE: 25



14355

(01533-00401)
Black Nylon

Retaining Clip
Nissan

UNIT PACKAGE: 50



14291

(66435-648-000)
Black Nylon

Retaining Clip
Honda

UNIT PACKAGE: 50



14349

(Mazda: 9926-40-543;
Nissan: 01553-00291)
Black Nylon

Retaining Clip
Mazda & Nissan

UNIT PACKAGE: 50



19014

(90467-10123)
Natural Nylon

Trim Panel Retainer
Toyota Celica 1993 - On

UNIT PACKAGE: 10



5592

(375372-S)
Black Nylon

Radiator Top Shield Retainer
Ford

UNIT PACKAGE: 100

Sec. 19

TRIMMING SUNDRIES & FASTENERS

Refer to Retainer Specification Chart on pages 475-489



19467

(91501-SL4-003)
Black Nylon

Front Cowl Retaining Clip
Acura 3.5 RL 1996 - On

UNIT PACKAGE: 25



22214

(Lexus: 90467-06015-C0)
Black Nylon

Front & Rear Bumper
Retaining Clip
Lexus GS 300, GS 400 &
GS 430 2005 - 1998

UNIT PACKAGE: 25



21626

(90467-06128)
Black Nylon

Weatherstrip
Retaining Clip
Toyota Camry &
RAV-4 1992 - On

UNIT PACKAGE: 25



21296

(90080-46010)
Black Nylon

Hood Seal Retaining Clip
Toyota Camry 2010 - On

UNIT PACKAGE: 50



18297

(Toyota: 90467-08004, 90467-08011;
GM: 94842841, 94849113)
Black Nylon

Hood Seal Retaining Clip
Lexus, Toyota, Geo Prizm
& Nova 1985 - On

UNIT PACKAGE: 50



21695

(Toyota: 90467-08045,
90467-08063)
Black Nylon

Hood & Weatherstrip
Retaining Clip
Toyota Yaris 2007 - On

UNIT PACKAGE: 25

**For the most up to date
information on all Auveco items,
including new items, inventory
and online ordering please visit
www.auveco.com**



14352

(76876-W5000)
Black Nylon

Retaining Clip
Nissan

UNIT PACKAGE: 50



14737

(Nissan: 01553-00172;
Toyota: 90467-07050, 90467-08008)
Black Nylon

Retaining Clip
Nissan & Toyota

UNIT PACKAGE: 25



14282

(90687-SA5-003)
Black Nylon

Retaining Clip
Honda

UNIT PACKAGE: 50



17452

(01553-00545)
Black Nylon

Bumper Fascia Retainer
Nissan Sentra 1990 - On

UNIT PACKAGE: 25



21692

(Lexus: 90467-07137)
Black Nylon

Fender Panel Retaining Clip
Lexus ES 350, GS 300,
GS 450h & IS 250 2006 - On

UNIT PACKAGE: 25

TRIMMING SUNDRIES & FASTENERS

Refer to Retainer Specification Chart on pages 475-489



22212

(Toyota: 53145-60030)
Black Nylon

Front Bumper, Grille &
Hood Seal Retaining Clip
Toyota Avalon, Camry, Highlander,
Land Cruiser, Prius & Venza and Lexus
GS 350, GS 450h, IS 250, IS 350, LX 570,
NX 200t, NX 300h, RX 350 & RX 450h
and Scion iQ & tC 2008 - On

UNIT PACKAGE: 100



22001

(Toyota: 90467-08030)
Black Nylon

Trim Retaining Clip
Toyota

UNIT PACKAGE: 25



21643

(90467-08101)
Black Nylon

Hood to Cowl Top Seal
Retaining Clip
Lexus ES 300 and Toyota Camry,
Sequoia, Solara & Tundra 2006 - 1997

UNIT PACKAGE: 25



18157

(90672-671-003)
Gray Nylon

Headliner & Cowl Grille
Retaining Clip
Honda Accord 1986 - On

UNIT PACKAGE: 25



14736

(90467-06161-01)
Black Nylon

Retaining Clip
Toyota

UNIT PACKAGE: 25



19331

(MB869072)
Black Nylon

Headliner & Trunk Trim Retaining Clip
Mitsubishi Diamante 1995 - 91

UNIT PACKAGE: 15



18271

(9926-40-531B)
Black Nylon

Hood Insulation Retainer
Mazda

UNIT PACKAGE: 25



17990

(90467-09138)
Black Nylon

Retaining Clip
Lexus 1990 - On

UNIT PACKAGE: 5



16781

(Honda: 90670-692-003;
Toyota: 90467-09065)
Black Nylon

Retaining Clip
Honda & Toyota

UNIT PACKAGE: 25



14348

(27948-M7002)
Black Nylon

Retaining Clip
Nissan

UNIT PACKAGE: 25



20381

(Honda: 90667-671-013ZA;
Mitsubishi: MC440901;
Nissan: 62660-48600-1)
Black Nylon

Trim Panel Retaining Clip
Honda, Mitsubishi & Nissan

UNIT PACKAGE: 25



19123

(90467-10107)
Black Nylon

Fender Apron Seal Clip
Toyota 2WD & 4WD Truck
1988 - On

UNIT PACKAGE: 10

Sec. 19

TRIMMING SUNDRIES & FASTENERS

Refer to Retainer Specification Chart on pages 475-489



21634
(90467-10186)
Black Nylon

Dash & Fender Apron Seal Retainer
Lexus and Toyota 1996 - On

UNIT PACKAGE: 25



22221
(Toyota: 90080-46327)
Black Nylon

Fender Apron Seal Retainer
Toyota Sequoia, Tacoma
& Tundra 2000 - On

UNIT PACKAGE: 50



22286
(Nissan: 80287-37F00)
Natural Nylon

Front Door, Garnish &
Interior Trim Retaining Clip
Overall Height: 11.5mm
Infiniti FX35, FX45, G35, G37 &
Q60 and Nissan Murano 2015 - 2003

UNIT PACKAGE: 25



22263
(Honda: 91504-TBA-A01)
Black Nylon

Grille Retaining Clip
Honda Civic 2016 - On

UNIT PACKAGE: 25



20882
(91501-SEA-003)
Black Nylon

Cowl & Garnish Retainer
Honda Civic 2006 - On

UNIT PACKAGE: 10



22054
(Honda: 91501-SNA-003)
Black Nylon

Front Fender, Cowl &
Dash Retainer
Honda Civic & CR-V 2014 - 06

UNIT PACKAGE: 15

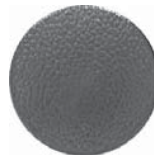

20671
(01553-0052U)
Black Nylon

Trim Panel Retaining Clip
Nissan Frontier &
Xterra 2000 - On

UNIT PACKAGE: 25



21757
(BMW: 51-48-8-181-420)
Black Nylon

Trim Panel & Trunk Lining Retainer
3 Series & 5 Series 2004 - 1988

UNIT PACKAGE: 25



19729
(90467-09050, 90467-A0003)
Black Nylon

Hood Insulation Retainer
Lexus, Toyota Camry &
Solara 1998 - On

UNIT PACKAGE: 15



19113
(90467-08124)
Black Nylon

Hood Insulation Retainer
Toyota Supra 1993 - On
Lexus 1994 - 89

UNIT PACKAGE: 15



19323
(MU481187)
Black Nylon

Hood Insulation Retainer
Mitsubishi Diamante 1993 - On

UNIT PACKAGE: 15



19385
(MB020923)
Gray Nylon

Hood Insulation Retainer
Jeep Eagle &
Mitsubishi Eclipse 1992 - On

UNIT PACKAGE: 10



22082
(Mitsubishi: MB655630)
Black Nylon

Hood Insulation Retainer
Mitsubishi Diamante &
Montero 2004 - 1992

UNIT PACKAGE: 15

TRIMMING SUNDRIES & FASTENERS

Refer to Retainer Specification Chart on pages 475-489



18878

(90467-08081)
Black Nylon

Hood Insulation Retainer
Toyota Celica 1993 - 89

UNIT PACKAGE: 15



19112

(90467-09004)
Black Nylon

Hood Insulation Retainer
Toyota Tacoma 1995 - On

UNIT PACKAGE: 15



14738

(90467-09008)
Black Nylon

Retaining Clip
Toyota

UNIT PACKAGE: 25



18842

(90467-09006)
Black Nylon

Hood Insulation Retainer
Toyota Avalon, Camry &
Lexus 1988 - On

UNIT PACKAGE: 15



21588

(80850-CA003)
Black Nylon

Weatherstrip Retainer
Nissan Murano & Rouge 2003 - On

UNIT PACKAGE: 25



21307

(BP4K-58-762)
Black Nylon

Weatherstrip Retaining Clip
Mazda 2007 - On

UNIT PACKAGE: 25



18114

(91520-SM4-C01)
Black Nylon

Hood Insulation Retaining Clip
Honda & Acura 1990 - On

UNIT PACKAGE: 25



20770

(Not Available from O.E.M.)
Yellow Nylon

Weatherstrip Retainer
Ford F Series Pick-Ups 2004 - On

UNIT PACKAGE: 100



19682

(91518-S10-003)
Black Nylon

Hood Seal Retaining Clip
Honda Odyssey 1999 - On

UNIT PACKAGE: 25



19114

(91518-SM4-003)
Black Nylon

Hood & Trunk
Moulding Retaining Clip
Acura Integra &
Honda Civic 1994 - On

UNIT PACKAGE: 10



21880

(Peugeot & Citroen: 6999.T4)
Black Nylon

Weatherstrip Retaining Clip
Peugeot & Citroen

UNIT PACKAGE: 50



21879

(Peugeot & Citroen: 6995.V6)
Black Nylon

Hood Insulation Retainer
Peugeot & Citroen

UNIT PACKAGE: 25



21520

(J001-56-741)
Black Nylon

Weatherstrip Retaining Clip
Mazda CX-7, Millenia,
MPV, 3, 6 & 626 1995 - On

UNIT PACKAGE: 25



18458

(Ford: F1CZ-16774-A;
Mazda: B455-56-741)
Black Nylon

Hood Insulation Retaining Clip
Ford Probe &
Mazda MX6 1992 - 88

UNIT PACKAGE: 25

Sec. 19

TRIMMING SUNDRIES & FASTENERS

Refer to Retainer Specification Chart on pages 475-489



21497

(1H0-837-719)
Black Nylon

Weatherstrip Retainer
with Clear Grommet
Audi A3 and VW Golf, Sharan,
Transporter & Corsa

UNIT PACKAGE: 25



14723

(62869-N4700)
Black Nylon

Retaining Clip
Nissan

UNIT PACKAGE: 25



17205

(91501-SM4-003)
Black Nylon

Cowl Top Retaining Clip
Honda Accord 1990 - On

UNIT PACKAGE: 15



16777

(Mazda: B001-68-302-00;
Toyota: 90950-01248)
Black Nylon

Retaining Clip
Mazda & Toyota

UNIT PACKAGE: 25



14353

(76906-T3000)
Black Nylon

Retaining Clip
Nissan

UNIT PACKAGE: 50



22046

(Subaru: 91167FA010)
Black Nylon

Front Hood Cowl Retaining Clip
Impreza 2001 - 1993

UNIT PACKAGE: 25



19124

(90467-07096)
Black Nylon

Side Trim Panel Retaining Clip
Toyota 4WD Truck 1989 - On

UNIT PACKAGE: 10



21908

(Renault & Dacia: 77-03-077-449)
Black Nylon

Trim Panel Retaining Clip
Renault & Dacia

UNIT PACKAGE: 25



21909

(Renault & Dacia: 82-00-110-307)
Gray Nylon

Trim Panel Retaining Clip
Renault & Dacia

UNIT PACKAGE: 25



21870

(Renault & Dacia: 77-03-077-457)
Light Gray Nylon

Trim Retaining Clip
Renault & Dacia

UNIT PACKAGE: 25



14347

(Nissan: 01553-00202;
Toyota: 90467-10018)
Black Nylon

Retaining Clip
Nissan & Toyota

UNIT PACKAGE: 50



14323

(38529-689A-6300)
Black Nylon

Retaining Clip
Honda

UNIT PACKAGE: 25



21758

(VW: 801-867-299-01C)
Black Nylon

Door Side Panel,
Luggage Compartment
and Armrest Tray Trim
Retaining Clip
Golf, GTI, Jetta & Rabbit 2005 - 1999

UNIT PACKAGE: 25

TRIMMING SUNDRIES & FASTENERS

Refer to Retainer Specification Chart on pages 475-489



16779

(Honda: 74842-659-0030;
Toyota: 90467-12078)
Black Nylon

Retaining Clip
Honda & Toyota

UNIT PACKAGE: 25



14720

(HB-121467)
Black Nylon

Retaining Clip
Mitsubishi

UNIT PACKAGE: 25



14380

(8133-50-022)
Black Nylon

Retaining Clip
Mazda

UNIT PACKAGE: 25



22071

(GM: 11546805)
Black Nylon

Front Fender Retainer
Chevrolet Colorado 2015 - On

UNIT PACKAGE: 50



21105

(001-988-03-25)
Black Nylon

Hood Insulation Retainer
Mercedes 2002 - On

UNIT PACKAGE: 15



21254

(90467-08136)
Black Nylon

Fender Seal Retaining Clip
Toyota Yaris 2009 - On

UNIT PACKAGE: 25



14356

(01553-00051)
Black Nylon

Retaining Clip
Nissan

UNIT PACKAGE: 50



14319

(90687-671-003)
Black Nylon

Retaining Clip
Honda

UNIT PACKAGE: 25



22209

(Chrysler: 68033045AA)
Black Nylon

Front & Rear Fender Flare
Retainer
Jeep Wrangler 2007 - On

UNIT PACKAGE: 15



20543

(81126-37010)
Black Nylon

Hood Insulation Retainer
Hyundai Elantra & Sonata
and Kia Optima 1995 - On

UNIT PACKAGE: 15



22254

(Mercedes-Benz: 000-991-74-98)
Black Nylon

Rocker Moulding Retaining Clip
Mercedes-Benz C, Cla, Cls, E,
Gla & S Class 2015 - On

UNIT PACKAGE: 15



22073

(Toyota: 76924-47020)
Black Nylon

Moulding Retainer
Lexus CT 200h &
Toyota Prius 2011 - On

UNIT PACKAGE: 15

Sec. 19

TRIMMING SUNDRIES & FASTENERS

Refer to Retainer Specification Chart on pages 475-489



21551

(67869-12050)
Black Nylon

Weatherstrip Retainer
Toyota Corolla &
Prius 2007 - 01

UNIT PACKAGE: 25



21991

(VW: 6L6-853-575A)
Black Nylon

Retaining Clip
VW, Audi, SEAT & Skoda

UNIT PACKAGE: 10



21509

(357-853-575)
White Nylon

Retainer
With Gray Grommet
VW Golf, Jetta,
Passat & Scirocco

UNIT PACKAGE: 25



20611

(90602-S7S-003)
Blue Nylon

Cowl Vent Retainer
Use with Auveco 20612
Honda Accord 2003 - On

UNIT PACKAGE: 25



21696

(Honda: 90602-S2A-003)
Pale Yellow Nylon

Cowl Retainer
Honda Civic, Element, Fit,
Insight & S2000 2001 - On

UNIT PACKAGE: 25



20576

(GM: 88969790;
Toyota: 75867-21010)
Yellow Nylon

Fender Flare Retainer
Pontiac Vibe &
Toyota Echo 2002 - On

UNIT PACKAGE: 25



21975

(Peugeot & Citroen: 6991.43;
Renault & Dacia: 77-03-077-059)
White Nylon

Trim Panel Retainer
Peugeot, Citroen,
Renault & Dacia

UNIT PACKAGE: 25



21871

(Peugeot & Citroen: 6995.A3;
Renault & Dacia: 77-03-077-111)
White Nylon

Trim Panel
Retainer with Sealer
Peugeot, Citroen,
Renault & Dacia

UNIT PACKAGE: 25



22153

(Land Rover: LR032984)
White Nylon

Front Door Louver Exterior Trim
Retainer with Sealer
Land Rover Evoque, HSE &
Range Rover 2014 - 2012

UNIT PACKAGE: 15



20571

(MR435918)
White Nylon

Rocker Panel
Retainer
Mitsubishi Montero 2001 - On

UNIT PACKAGE: 15



20642

(000-990-57-92)
Gray Nylon

Door Panel Retaining Clip
Mercedes-Benz

UNIT PACKAGE: 10



19320

(MB696120)
White Nylon

Side Garnish &
Moulding Trim Retainer
Mitsubishi Eclipse 1994 - On

UNIT PACKAGE: 15