

\$13.50

# Auveco<sup>®</sup>

## PRODUCTS

*Over 23,000 Items Available*



**The Encyclopedia of the  
Automotive Body Hardware Industry**

# Discover Auveco



My Account | Contact Us | Español | Français

Search by Keywords...  
Advanced Search

HOME | OEM MFG | PRODUCTS | ORDER EXPRESS | OEM/COMPETITIVE INTERCHANGE | TECHNICAL INFORMATION | MORE

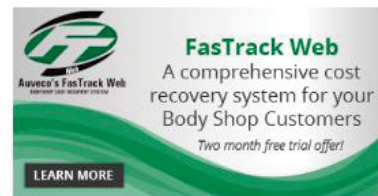
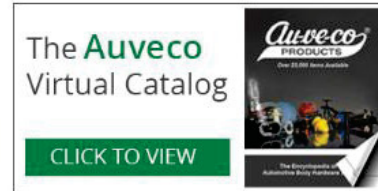

Auveco has recently revamped their entire website. They've made a user friendly experience for you to easily navigate their over 22,000 parts. The ordering platform has been hugely improved to ensure accuracy and a quick order turn around.

## Ordering made easy

Online  
Auveco.com



By Phone  
800-354-9816



By Email  
mail@auveco.com

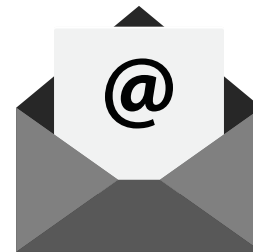

## “Then, Now, and Serving you into the Future”

For over a 100 years, Auto-Vehicle Parts LLC (Auveco) has been manufacturing and distributing specialty automotive and industrial fasteners.

Originally, Auveco manufactured trim parts and accessories for horse drawn carriages. After four generations, Auveco is still family owned.

We are the **World's Leader** in servicing customers' needs for Automotive Body Hardware and Specialty Fasteners through our worldwide distributors.

We market our products through traditional channels of distribution, selling only to authorized Distributors and O.E. Manufacturers. We provide three types of packaging: small Unit Package quantities, a One-Price Package retail program for PBE Jobber stores and Bulk quantities for the Expediter/Distributor and O.E. Manufacturer.

With over 22,000 items our catalog is regarded as the *Encyclopedia of the Automotive Body Hardware Industry*.

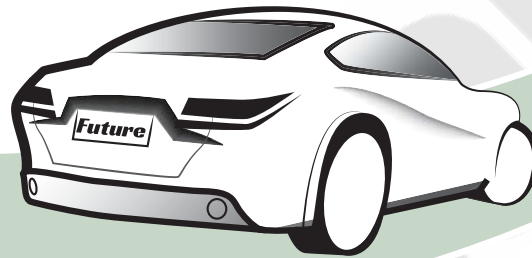
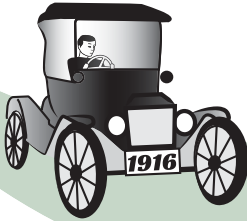

### Technology

We are continually upgrading to the latest technology including our warehouse fulfillment system to achieve accuracy and order turn around. Most orders are shipped within 2 hours with a 98.6% fill rate.

#### New e-commerce site:

- Multi-device user experience, as well as, multiple language options
- Improved category search with new drill down search capability
- New OEM and competitive item search capabilities
- Updated and thorough product information and images
- Revitalized features for tracking and placing orders and requesting quotes
- Up to date stock availability

#### EDI capabilities:

- Trading Purchase Order, PO Acknowledgment, Advanced Shipping Notices (ASN) and Invoice documents with a growing group of trading partners

**FasTrack Web:** *Internet based Cost Recovery Software that allows collision centers to efficiently invoice all clips and fasteners used during a repair.*

- Recently updated interface with new modern look
- CCC® Estimating integration allowing users to import FasTrack invoices to their system
- New tutorial videos demonstrating how to effectively use particular sections of FasTrack
- OEM Crossover updated daily with newest Auveco items
- Capability to enter OEM numbers directly to an invoice
- Ability to add Kits such as core support, truck bed side, front bumper, door side, etc.

### Complete Customer Satisfaction with our Products and Services

To maintain a level of excellence we go beyond a dedication to product availability. We continually add to our product line on a biweekly basis and insist upon a dedication to quality of services at all levels throughout the company.

Our customer service and technical staff is fully trained to make sure that we can answer all your questions regarding product availability, pricing, delivery and technical information. We can even supply detailed, custom sales analysis to guide customers in the selection of new products that ensures their sales growth.

### Into the Future

Our goal of further enhancing customer satisfaction is limited only by our imagination and your needs. Let us know what we can do to better serve you. As we continually strive to service our customers across the country and beyond, it's no wonder that when people around the world think of Automotive Body Hardware & Specialty Fasteners, they think of Auveco.



# World's Largest Body Hardware and Specialty Fastener Selection

## From Manufacturing to Distributing



## Shipping







## Unit Packaging



## Bulk Packaging





# AuvecoPak Retail Package Program

One Price Per Pak

# 448

of the  
fastest moving,  
most popular  
automotive  
body hardware  
and  
specialty fasteners



The AP448S (Starter Merchandiser) consists of one package each of the 448 part numbers.

The AP448L (Large Assortment) includes two packages each of the 224 most popular items and one package each of the other 224 part numbers for a total of 672 packages.

AuvecoPak packages feature, contemporary graphics with all the necessary application and descriptive information in trilingual verbiage (English, Spanish and French-Canadian).

Re-ordering is a breeze, the AuvecoPak part number and UPC-A bar code are on the panel back-up boards beneath each hook. Restocking the merchandiser is also quick and easy with the AuvecoPak packages' locator codes identifying their specific location on the panels.

*For more detailed information about the AuvecoPak Retail Package Program,  
refer to pages 317 to 323*





# FasTrack Web

*A Body Shop Cost Recovery System*

FasTrack is an easy-to-use, web base application designed to assist body shops and dealerships in recovering the cost of the body repair clips and fasteners used in daily collision repairs.

The cost of fasteners used in collision damage repair is often an expense that is not recovered by shops. Insurance companies consider these items “a cost of doing business” and are either reluctant or refuse to pay claims for these items unless they are presented with an itemized invoice detailing the cost of these items.

FasTrack Web makes it fast and easy to manage these parts and turn them into a source of additional income for your shop.

## Features:

- Integration with CCC® Estimating
  - CCC ONE is the largest estimating service in the U.S.
  - Enables end users to send invoices seamlessly and easily to CCC's estimating system
- The ONLY supplemental invoicing system on the market using the OEM pricing structure that is widely accepted and requested by insurance companies across the country
- Extensive data base of over 10,000 collision repair fasteners by Auveco
- Distributors can add multiple items. As well as, their own unique part numbering system.
- Shop Items give the body shop the ability to also add their own items
- Kit Management allows the distributor or the shop to build their own specific repair kits, as well as, pre-designed kits
- Labeling functions allow for printing individual bar code labels and new drawer lid labels
- Barcode scanning can be done with our app using any smart phone or with our wedge scanner
- Reporting and Inventory Management allows the distributor to gather information on product usage at the shop level for all supported shops
- Body Shops can now sign up directly by filling out order form and adding an authorized Auveco distributor name
- No annual updates, as all data resides on our Internet server and is always up to date
- Can be accessed from any computer with Internet access
- Site protected by Verisign Internet Security.

***Auveco's FasTrack Web is only offered through authorized Auto-Vehicle Parts LLC distributors.***  
*For a distributor in your area call customer service at 1-800-354-9816.*

*For more information or to start your FREE two month trial visit [www.auveco.com](http://www.auveco.com) or call 1-800-354-9816 x103*



Over **500**  
Pre-packaged  
Assortments

Custom Packaging  
Capabilities





# "428" Display Boards



Over 428 of the most popular body hardware and fastener items are shrink-wrapped onto seven different boards. Each board contains product groups, body shops are familiar with and use often.

We recommend every distributor sell these convenient display boards to body shops.

The back of each board contains each part number, unit package quantity, OEM number and size specification. The backs are protected by a clear plastic liner.

## Binder with Display Boards, DB-428-9



## Product Numbers and Descriptions

### DB-420-0

Display Board Binder:  
Holds up to 8 boards

### DB-428-1

Retainers and  
Push-type Retainers

### DB-428-2

Push-type Retainers

### DB-428-3

Tapping Screws

### DB-428-4

Body Bolts and Nuts

### DB-428-5

Speed, Nylon & Thread Cutting  
Nuts. Push-on &  
Pushnut Bolt Retainers

### DB-428-6

Specialty Rivets, Door Hinge Pins &  
Bushings, Trim Clips and Fasteners

### DB-428-7

Moulding & Wire Loom Clips,  
Vacuum Caps, Shims, Plastic Plugs  
and Cable Straps

### DB-428-8

Assortment of boards  
DB-428-1 through DB-428-7

### DB-428-9

Binder and boards DB-428-1  
through DB-428-7

# Auveco Green Catalog

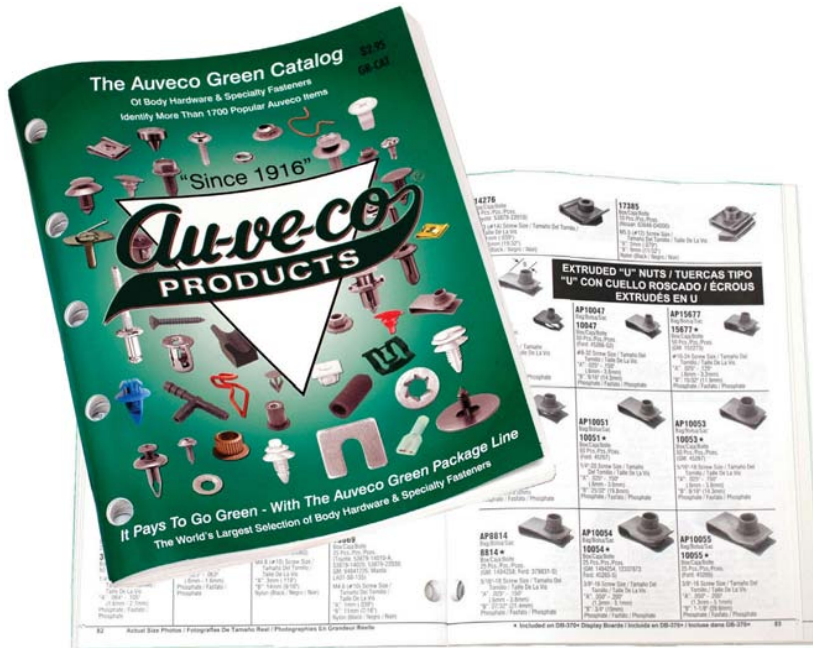

1700  
of the most  
popular  
part numbers

a must have for all body shops

For your convenience we've created a condensed version of our catalog. The Auveco Green Catalog contains over 1,700 of the most popular Auveco part numbers. Parts are divided by product group into 45 different sections. The clean, concise format makes it quick and easy to find the right part.

## Features:

- Trilingual verbiage: English, Spanish and French-Canadian
- Actual size images of products
- O.E.M. numbers
- Part specifications, dimensions, colors and plating information
- Includes AuvecoPak part numbers for customers that have the AuvecoPak Retail Merchandiser
- Auveco Display Boards items are identified with a ★ symbol.



# NAVIGATING THE CATALOG

## **Quick Index:** *A pictorial index*

- Picture examples to help you locate the pages of similar parts
- Section numbers correspond to the section numbers printed in the upper outside corner of each catalog page.

## **Alphabetical Index**

- Allows you to check if we carry a specific product line.
- Popular categories are in bold type.

## **Numerical Index**

- Gives you the capability to look up a part based on the Auveco part number

## **Helpful Tips**

- All parts are displayed as actual size, unless labeled “not actual size” or is a picture accompanying a chart. As actual size you will be able to set a part on top of the picture to positively identify it.

- We have included Specification Charts to assist you in the identification of various types of fasteners.

Charts can be found on the following pages:

- Body Bolts- Pages: 88 & 121-122
- Special Tapping Screws- Pages: 91-94 & 128-130
- License Plate Screws- Pages: 105-106
- Retainers- Pages: 475-489
- Push-Type Retainers- Pages: 534-545

Charts list the pertinent dimensions, plating and color information, as well as, the page number on which the actual size picture and application information is shown for each item.

- At the back of the catalog are two O.E.M. part number to Auveco part number Cross References.

One of these interchanges is broken down by O.E. manufacturer i.e., General Motors, Ford, etc.

The other interchange combines all O.E.M. numbers together and is sequenced strictly in alphanumeric order regardless of the manufacturer.

## **New Items** Pages 44-68

## **Screws** Pages 69-115

## **Metric Items** Pages 116-151

## **Nuts** Pages 152-179

## **Washers, Shims & Retaining Rings** Pages 180-190

## **Springs, Pins, Clips, Plug Buttons, Caps & Connectors** Pages 190-201

## **Air Line Couplings & Accessories, Tubing and Hose** Pages 202-203

## **Electrical Accessories** Pages 204-270

## **Wire Loom & Clips and Cable & Harness Straps** Pages 270-274

## **Oil & Transmission Drain Plugs & Gaskets and Grease Fittings & Accessories and Brass Fittings** Pages 275-295

## **Rivets & Accessories and Drills & Sets** Pages 293-316

## **Assortments, Cabinets, Bins & Racks** Pages 317-385

## **O-Rings, Grommeting, Tire Valves, Weatherstrip, Rubber Bumpers & Grommets, Caps and Seals & Channels** Pages 386-399

## **Glass Shop Supplies and Horns** Pages 400-408

## **Trimming Sundries & Fasteners and Push-Type Retainers** Pages 409-546

## **Domestic Car Clips & Fasteners** Pages 547-634

## **Key Blanks & Accessories** Pages 634-641

## **Import Car Clips & Fasteners** Pages 642-823

## **Universal Type Moulding Fasteners** Pages 824-825

## **Ball Joint Assemblies, Yoke Ends and Clamps & Accessories** Pages 826-835







## **Engine Manifold Repair Kit, Body Sealer and Epoxy Repair Kits** Pages 836-838

## **Miscellaneous Items** Pages 839-846

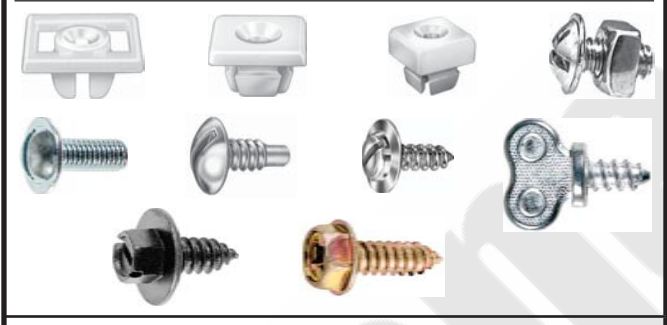
## **Tools** Pages 847-856

# QUICK INDEX

Photos not actual size

<p><b>Section 1 Pages 69-76</b></p> <p><b>Tapping &amp; Wood Screws</b></p> 	<p><b>Section 5 Pages 105-113</b></p> <p><b>License Plate Screws &amp; Fasteners</b></p> 
<p><b>Section 2 Pages 77-85</b></p> <p><b>Cap, Machine &amp; Set Screws, Carriage, Frame &amp; Stove Bolts and Stainless Steel Fasteners</b></p> 	<p><b>Section 6 Pages 114-115</b></p> <p><b>Cylinder Head &amp; Manifold Studs</b></p> 
<p><b>Section 3 Pages 86-90</b></p> <p><b>Bumper &amp; Body Bolts</b></p> 	<p><b>Section 7 Pages 116-151</b></p> <p><b>Metric Items</b></p> 
<p><b>Section 4 Pages 91-104</b></p> <p><b>Special Tapping Screws</b></p> 	<p><b>Section 8 Pages 152-158</b></p> <p><b>Standard, Special and Thread Cutting Nuts and Wheel Studs, Bolts &amp; Nuts</b></p> 



# QUICK INDEX

*Photos not actual size*

## Section 9 Pages 159-179

Nutsert® & Thread Repair Inserts. Teenut®, Jack Nut® & Well Nut®. Tubular, Flat, U, & J-Nuts



## Section 12 Pages 204-274

Electrical Accessories, Wire Loom & Clips, Cable Ties and Bulbs



## Section 10 Pages 180-196

Washers, Shims, Retaining Rings, Springs, Pins, Yoke Ends, Spring Pins, Plugs and Straight & Woodruff Keys



## Section 13 Pages 275-292

Oil Drain Plugs & Gaskets, Grease Fittings & Accessories and Brass Fittings



## Section 11 Pages 197-203

Caps, Connectors, Airline Couplings & Accessories and Tubing & Hose

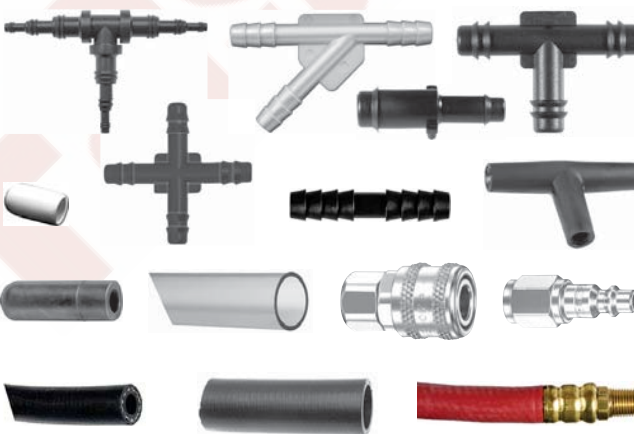

## Section 14 Pages 293-316

Rivets & Tools and Drill Bits



# QUICK INDEX

Photos not actual size

## Section 15 Pages 317-385

AuvecoPaks, Assortments, Cabinets, Drawers and Special Racks



## Section 16 Pages 386-399

O-Rings, Grommets, Tire Valves, Weatherstrip, Rubber Bumpers & Caps, Hold Down Straps and Glass Setting Channels



## Section 17 Pages 400-405

Glass Shop Supplies



## Section 18 Pages 406-408

Window Lift Motor Gears, Air Conditioning Motors and Horns



## Section 19 Pages 409-546

Trimming Sundries & Fasteners, Snap & Curtain Fasteners, Push-Type Retainers and Truck Seat Springs





# QUICK INDEX

*Photos not actual size*

## Section 20 Pages 547-634

### GM, Ford, Chrysler & AMC Clips and Fasteners



## Section 22 Pages 642-823

### Import Clips and Fasteners



## Section 21 Pages 635-641

### Key Blanks, Locks and Locks Hardware & Accessories



## Section 23 Pages 824-825

### Universal Moulding Fasteners



## Section 24 Pages 826-830

### Ball Joint Assemblies

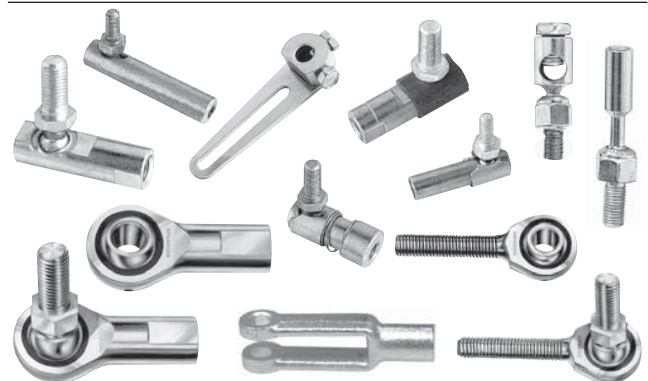

# QUICK INDEX

Photos not actual size

## Section 25 Pages 831-835

### Hose & Tubing Clamps



## Section 27 Pages 839-846

### Miscellaneous Items



## Section 26 Pages 836-838

### Manifold Repair Kit and Body, Seam-n-Joint & Epoxy Sealer. FixitQuik Epoxy Putty



## Section 28 Pages 847-856

### Tools, Plain White Boxes and Lubrication Items





## ALPHABETICAL INDEX

**A**

Abrasives	67-68
Acorn Nuts	85, 140, 154
Acura Clips & Fasteners	642-649
Adhesive Weatherstrip	390-392
Aerosol Can Caddy	336
Air Conditioning O-Rings	388-389
Air Hose	203
Air Line Couplings & Accs.	201-202
Alignment Shims	184
Anchor Shackles	843
Anchors	842-843
Anti-Corrosion Protectant	230
Assortments (Green Pages)	317-385
Audi Clips & Fasteners	808-821
Auto Bulbs	258-267
Auveco Body Sealer	837
Auveco "Fix-Kits"	343-363
Auveco Flex & Rigid Sealer	837
AuvecoPak	317-323
Avex® Blind Rivets	299

**B**

Ball Joint Assemblies	826-830
Barrel Nuts	143, 169-170
Battery:	
Cable	227
Hold Down Bolts	846
Terminals & Bolts	224-229
Tools	229-230
Belt Weatherstrips	397
Bin Labels	337
Bins	335-336
Bits:	
Drill	316
Torx® (Drivers & Inserts)	70, 131, 850
Blades, Razor	848
Blind Rivets	293-294, 297-300
Blow Gun Accs.	202
BMW Clips & Fasteners	650-657
Body Bolts:	
Metric	120-128
U.S.	88-90
Body Hardware Master Asst.	324-331
Body Sealer	837
Body Shop Bin Assortments	338
Bolt Extractor Kit	852
Bolt Retainers:	
Metric	141
U.S.	154
Bolts:	
Battery	227-229
Battery Hold Down	846
Body:	
Metric	120-128
U.S.	88-90
Bumper	86-87, 137
Carriage	79
Grade 5	81
Grade 8	82
Hex Flange Frame	80
Hex Flange Serrated (Metric)	120
Hex Head Sems Split	
Wave Washer (Metric)	120
License Plate	105-111

**Bolts continued:**

Spin Lock	77
Stainless Steel	84
Stove	77
Boxes, Plain White	852
Brackets, Rear View Mirror	404
Brass Fittings	287-292
Brass Grommets	411
Brass Nuts	152
Brushes	
(Acid, Chip, Dope & Scratch)	841-842
Bulbs, Light	258-267, 841
Bulbs, Miniature	258-259
Bumper Bolts	86-87, 137
Bumpers, Rubber	394-396
Buttons:	
Plug	195-196
Trim	410
Bushings:	
All-Fit Adjustable	843
Door Hinge	592-593, 615, 632
Nylon Spacer (Stand-Offs)	843
Standard Insulating	843

**C**

Cabinets & Accessories	331-336, 352
Cable:	
Battery	227
Tailgate	588
Tie Mounts	274
Tie Tool	274
Ties	272-274
Cage Nuts	142, 154, 174
Can Caddy	336
Canvas & Curtain Fasteners	414-415
Cap Screws:	
Metric	117-119
Socket Head, Metric	119
Stainless Steel	84
U.S. (Gr. 5 & Gr. 8)	81-82
Caps, Rubber & Vinyl Vacuum	197, 399
Carriage Bolts	79
Caulking Guns	856
"Christmas Tree" Retainers	415-489
Chrysler Clips & Fasteners	616-633
Circuit Breakers	230
Circuit Tester	224-225
Clevis Ends	194, 830
Clevis Pins	193
Clamps:	
Hose	831-834
Tubing	270, 834-835
Clip Removal Tool	848
Clips:	
Acura	642-649
AMC	634
Audi	808-821
BMW	650-657
Chrysler	616-633
Fiat	657-658
Ford	594-616
General Motors	547-593
Honda	658-681
Hyundai	682-688
Infiniti	689-693

**Clips continued:**

Isuzu	694
Jaguar	695
Kia	694-700
Land Rover	700-702
Lexus	703-715
Mazda	715-725
Mercedes-Benz	726-733
Mini-Cooper	733-734
Mitsubishi	735-739
Nissan	739-757
Opel	757
Peugeot & Citroen	758-763
Renault & Dacia	764-770
Saab	770
SEAT & Skoda	808-821
Subaru	770-776
Suzuki	777
Toyota	778-808
Volkswagen	808-821
Volvo	822-823
Universal	823
Window Reveal Moulding	401-403
Wire Loom	270-271
Closed-End Connectors & Terminals	211
Co-ax Cable Clips	270
Compression Battery Terminals	228
Compression Springs	191
Conditioning Disc	68
Connectors:	
Air Line	201-202
Electrical	204-213, 224, 236-257
Nylon Vacuum	197-201
Polyethylene	201
Rubber	201
Trailer	257
Twist-Type Wire	224
Copper Washers:	
Metric	146
U.S.	181
Cord, Sponge Rubber	394
Cotter Pins:	
Metric	149
Stainless Steel	84
U.S.	193
Covers & Bases, Screw	70, 412
Crimping Tools (Electrical)	222-223
Curtain Fasteners	414-415
Cutoff Wheels & Mandrels	854
Cylinder Head Studs:	
Metric	115,138
U.S.	150

**D**

Damper Control (Arm)	828
Dampening Pads	
(Trunk/Vibration/Sound)	840
Defroster Repair Products	44-45
Disc:	
Mini Grinding	68
Surface Conditioning	68
Strip-Brite	68
Twist-to-lock Holders	68
Display Boards	8
Door Handle Clips	400-401

# ALPHABETICAL INDEX

Door Hinge:	
Bushings	592-593, 615, 632
Hinge Pins	591-592, 615, 633
Hinge Pin & Bushing Repair Kit	588-591, 633
Door Lock Striker	
Bolt Assemblies	587, 615
Door Locks	640
Door Seals	397
Double End Threaded Studs:	
Metric	115, 138
U.S.	150
Drain Cocks & Valves	291-292
Drain Plugs & Gaskets	275-282
Drill Bits	316
Drill-Out® Bolt Extractor Kit	852
<b>E</b>	
E Type Retaining Rings	147, 186, 189
Electrical Connectors	204-213, 224, 236-257
Electrical Pigtails & Sockets	236-257
Electrical Section (Brown Pages)	204-274
Electrical Tape	230
Electrical Terminals	204-222
Electrical Crimping Tools	222-223
Electronic Fuel Injection Hose	203
Engine Manifold Repair Kit	836
Epoxy, Flexible & Rigid	837
Epoxy Putty	838
Expansion Plugs:	
Metric	149
U.S.	846
Extension Springs	190, 380
Extruded U-Nuts	145, 176-179
<b>F</b>	
Fastener Assortments	339-342
Fasteners, Universal Moulding	824-825
FasTrack	6
Fender Shims	184
Fender Welt	410
Fiat Clips & Fasteners	657-658
Fittings:	
Brass	287-292
Grease (Metric)	148, 285
Grease (U.S.)	283-284
"Fix-Kit" Labels	333
"Fix-Kits"	343-363
Flange Bolts	80
Flange Lock Nuts:	
Metric	139
U.S.	80
Flashlights	854
Flat Nuts	170-171
Flex-Fit Rubber Moulding	398
Flexible Setting Epoxy	837
Fluorescent Work Light	855
Foldover Nuts	145, 176-179
Footman Loops	410
Ford Clips & Fasteners	594-616
"FP" Kits	382-384
Frame Bolts	80
Free Spinning Washer Nuts:	
Metric	139
U.S.	155

Fuel Line Clips	610-611
Fuel Line Hose	203
Fuse Tap	208, 234
Fuses, Fuseholders & Accs.	232-235
Fusible Link Wire	226-227
<b>G</b>	
Gas Pump Nozzles & Accs.	845
Gaskets, Oil Drain Plug	275-282
Gauges	835
General Motors Clips & Fasteners	547-593
Glass Setting Blocks	400
Glass Setting Channel	398
Glass Shop Supplies	400-405
Gloves	840-841
Grease Fittings:	
Metric	148, 285
U.S.	283-284
Grease Guns & Accs.	286
Green Catalog	9
Grinding Disc	68
Grommets:	
Brass	411
Rubber & Vinyl	389-390, 394-396
Grooveless Retaining Rings	190
Ground Strap, Engine	228
<b>H</b>	
Hair Pin Cotters	192-193
Halogen Headlight Bulbs	260, 263-265, 267
Hammer Drive Anchors	842
Hand Sanding Pads	67
Handles, Window Crank & Door:	
Ford	616
General Motors	593
VW	821
Hanger Strap	845
Harness Connectors	236-257
Headlight Adjusting Assy.:	
AMC	634
Chrysler	616
Ford	594
General Motors	547-549
Toyota	778
VW	808
Headlight Adjusting Springs:	
General Motors	549
Headlight Resurfacers	840
Headliner Tools	847-848
Heat Shrink Tubing	231
Heater Hose	203
Helical Threaded Inserts	166
Hex Key Sets	851
Hex Keys:	
Metric	119, 851
Torx®	851
U.S.	851
Hex Lock Nuts (Pal Nuts)	154
Hex Nuts:	
Metric	138
U.S.	152-153
Hinge Bushings (Door)	592-593, 615, 632
Hinge Pins (Door)	591-592, 615, 633
Hog Ring Pliers	850

Hog Rings	410
Hold Down Straps	399
Hole Punch	856
Hollow Wall Anchors	842
Honda Clips & Fasteners	658-681
Hood Bumpers	394-396
Hood Prop	850
Hook, "S"	399
Horns & Horn Relay	406-408
Hose:	
Air	203
Electronic Fuel Injection	203
Fuel Line	203
Heater	203
Vacuum & Windshield Washer Tubing	203
Hose Clamps	831-834
Hose Clamp Pliers	831, 849
Hose Clamp Rack	335
Hose, Tubing & Wire Dispenser	333
Hyundai Clips & Fasteners	682-688
<b>I</b>	
Ignition Locks	640
Import Vehicle Section	642-823
Indicator Lamps (Toggle Switch)	270
Infiniti Clips & Fasteners	689-693
Interior Trim Buttons	409-410
Isuzu Clips & Fasteners	694
<b>J</b>	
J Nuts	142-144, 172-173
J Type Cage Nuts	174
Jack Nuts®	167
Jaguar Clips & Fasteners	695
J.I.S. Cap Screws	118
J.I.S. Flange Bolts	120
J.I.S. Hex Nuts	138
<b>K</b>	
Key Blanks & Accs.	635-641
Keys:	
Hex	119, 857
Straight	196
Woodruff	196
Kia Clips & Fasteners	695-700
Kits (Green Pages)	317-385
<b>L</b>	
Labels, Bin & Lid	33, 337
Land Rover Clips & Fasteners	700-702
Lexus Clips & Fasteners	703-715
License Plate Nuts & Screws	105-113
Light Bulbs	258-267, 841
Lock & Accs.	640
Locking Hole Plugs	196
Loom, Wire	225
Lubrication Fittings	148, 283-285
Lynch Pins	193
<b>M</b>	
Machine Screws:	
Metric	116
Stainless Steel	83
U.S.	77-78



## ALPHABETICAL INDEX

Magnetic Chucks	851	Nuts <i>continued:</i>		Nylon Connectors	197-200
Manifold Repair Kit	836	Cage	142	Nylon Insert Lock Nuts:	
Manifold Studs:		Collared (Battery)	229	Metric	138
Metric	138	Extruded U	145, 179-179	U.S.	85, 152
U.S.	114-115	Flat	170-171	<b>O</b>	
Marine Fasteners	414-415	Free Spinning Washer	139, 155	O- Ring Assortments	385
Marker Light Assemblies	243	Hex:		O-Rings:	
Maxi-Fuses	235	Brass	152	Air Conditioning	388-389
Mazda Clips & Fasteners	715-725	Flange	140	Metric	387
Mega Fuses	235	Flange Lock	80, 139	Rubber (U.S.)	386
Mercedes-Benz		Frame (Flange Lock)	80	O.E.M. Electrical Terminals	214-221
Clips & Fasteners	726-733	Free Spinning Washer	139, 155	Oil Cans	856
Mechanics Wire	845	Grade 5 & Grade 8	153	Oil Drain Plugs & Gaskets	275-282
Metric Items (Blue Pages)	116-151	Keps Lock Washer	153	Opel Clips & Fasteners	757
Micro Fuses	235	Machine Screw	85, 152	<b>P</b>	
Mini-Cooper Clips & Fasteners	735-734	Metric	138	PAL Fuses	233
Mini Fuses	235	Nylon Insert	85, 138, 152	Pal Nuts:	
Mini Grinding Disc	68	Prevailing Torque	152	Metric	140
Miniature Bulb Cabinet	33	Reversible Lock	152	U.S.	154
Miniature Bulbs	258-259	SAE (Fine)	152-153	Peel-Bak Weatherstrip	391
Mitsubishi Clips & Fasteners	735-739	Slotted	152	Peugeot & Citroen	
Monobolts® & Tools (Rivets)	301	Spin Lock	140, 154	Clips & Fasteners	758-763
Moulding Clips:		USS (Coarse)	152-153	Piano Wire	405
Acura	642-649	J Type Nuts	142-144, 172-173	Pigtail Connectors	236-257
AMC	634	Jack Nuts®	167	Pins:	
Audi	808-821	J.I.S.	138	Clevis	193
BMW	650-657	License Plate	109-113	Cotter:	
Chrysler	616-633	Lock	139-140, 152-154	Hammerlock, U.S.	193
Fiat	657-658	Metric	138-145	Metric	149
Ford	594-616	Nylon	85, 109-112, 138, 152	Stainless Steel	84
General Motors	547-593	Pal Nuts:		Hair Pin	192-193
Honda	658-681	Metric	140	Lynch	193
Hyundai	682-688	U.S.	154	Retainer	191
Infiniti	689-693	Pushnuts, Bolt Retainers:		Spring/Roll	194
Isuzu	694	Metric	141	Weld	839
Jaguar	695	U.S.	154	Pipe Fittings	286, 289-291
Kia	694-700	Self-Threading:		Plain White Boxes	852
Land Rover	700-702	Metric	141	Plastic & Headlight	
Lexus	703-715	U.S.	155	Resurfacers/Protector	840
Mazda	715-725	Specials	175	Plastic Plug Buttons	195-196
Mercedes-Benz	726-733	Speed (Extruded U, Flat, J, U & Tubular)		Plastic Wrap	839
Mini-Cooper	733-734	Metric	140-141	Pliers, Retaining Ring	190, 850
Mitsubishi	735-739	U.S.	155	Plug Buttons, Steel,	
Nissan	739-757	Spin Lock:		Nylon & Plastic	195-196
Opel	757	Metric	140	Plugs:	
Peugeot & Citroen	758-763	U.S.	154	Drain	276-282
Renault & Dacia	764-770	Spring	174	Expansion:	
Saab	770	Square	153	Metric	149
SEAT & Skoda	808-821	Stainless Steel	85	U.S.	846
Subaru	770-776	Teenuts	159	Locking Hole	196
Suzuki	777	Thread Cutting:		Pipe	286, 289-291
Toyota	778-808	Metric	140-141	Polyethylene	195
Volkswagen	808-821	U.S.	155	Polyethylene Hose Connectors	201
Volvo	822-823	Tubular	141, 169-170	Pop-On Screw Covers & Bases	70, 412
Universal	823	U-Nuts	142-145, 172-179	Power Window Lift Motor Gear Kits	405
Window Reveal Moulding	401-403	Washer Lock Nuts:		Power Window Regulator Gears	405
Moulding Cutting Tool	853	Metric	140	Prep Pen	849
Moulding Tape	839	U.S.	154	Prevailing Torque Locknuts	152
<b>N</b>		Well Nuts®	168	Primary Wire	226
"Nipper" Wire Rope Clips	844	Wheel	156-157	Push-On Retainers:	
Nissan Clips & Fasteners	739-757	Wing:		Metric	141
Nuts:		Metric	140	U.S.	154
Acorn	85, 140, 154	U.S.	84, 153-154		
Brass	152	Nutserts® & Tool	160-163		
		Nylon Anchors	842		
		Nylon Cable Ties	272-274		

# ALPHABETICAL INDEX

<b>Pushnut Bolt Retainers:</b>	
Metric	141
U.S.	154
Pushnut Fasteners	141, 154, 844
Push-Pull Controls	845
Push-Type Retainers	490-533
Specification Chart	534-545

<b>Q</b>	
Quik-Select Assortments	370-380
Quik-Select Boxes	370
Quik-Select II Assortments	364-369
Quik-Select II Boxes	364

<b>R</b>	
<b>Racks:</b>	
Hose Clamp	335
Threaded Rod	334
Wire Spool	334
Razor Blades & Scraper	848
Rear View Mirror Brackets	464
Renault & Dacia	
Clips & Fasteners	764-770

<b>Retainers:</b>	
<b>Bolt:</b>	
Metric	141
U.S.	154
Pins	191
<b>Push-On:</b>	
Metric	141
U.S.	154
Push-Type	490-533
Push-Type	
Specification Chart	534-545
"Xmas Tree"	415-474
"Xmas Tree"	
Specification Chart	475-489

Retaining Rings & Pliers	185-190, 850
Rigid Setting Epoxy	837
Rivet Guns & Nosepieces	295-296
Rivet Washers	295

<b>Rivets:</b>	
Avex®	299
Blind	293-294, 297-300
Closed-End	302
Klamp-tite	300
Large Secondary Head	300
Monobolt®	301
Multi-Grip	298
Nylon	297-298
Pan'l (Pop®)	293-294, 298
"Peel-Type"	302-306
Plywood	299
Solid Aluminum	293
Specialty	307-315
Stavex® Large Flange	299
Tacking	300
Ultragrip	302
Rod End Ball Joints	826-827
Roll/Spring Pins	194
Rough Service Light Bulbs	841
Routing Clips	270-271
<b>Rubber:</b>	
Bumpers	394-396
Caps	197, 399

<b>Rubber continued:</b>	
Connectors	201
Grommets	389, 394
Hold Down Straps	399
O-Rings	386
Tape	230
Weatherstrip	391-394, 397

<b>S</b>	
"S" Hooks	399
Saab Clips & Fasteners	770
SEAT & Skoda	
Clips & Fasteners	808-821
Screw Anchors	842
Screw Covers & Bases	70, 412
Screw Pin Anchor Shackles	843
<b>Screws:</b>	

<b>Cap:</b>	
Grade 5	81
Grade 8	82
Metric	117-119
Stainless Steel	84
Drill Point	73
<b>Hex:</b>	
Lag	75
Regular	74
Sems®	72, 75, 88-104

<b>Washer Head:</b>	
Acorn	73
Regular	74
Slotted	72-73
Teks®	74
Type F	73
License Plate	105-111
<b>Machine:</b>	
Metric	116
U.S.	77-78, 83

<b>Phillips:</b>	
Hex Washer Head Tapping	73
Flat Head Tapping	70
Flat Head Wood	76
Flat Top Washer Head Tapping	72
Oval Head Machine	77, 116
Oval Head Sems® Tapping	72
Oval Head Sems® Teks®	72
Oval Head Tapping	69, 83
Oval Head Teks® Tapping	69, 72
Pan Head Machine	78, 116
Pan Head Sems® Tapping	72
Pan Head Tapping	71, 83
Pan Head Teks®	74
Round Head Machine	78, 83
Self-Piercing	73
Set	79, 120

<b>Slotted:</b>	
Fillister Head Metric	116
Flat Head Machine	116
Hex Head Self-Piercing	73
Hex Washer Head Tapping	75
Oval Head Tapping	69
Pan Head Machine	116
Pan Head Tapping	71
Pan Head Type F	72
Round Head Machine	78, 83
Socket Head Cap (Metric)	119

<b>Screws continued:</b>	
<b>Socket Head Set:</b>	
Metric	120
U.S.	79
Specialty	91-104, 128-137
Stainless Steel	83-84
Stove Bolts	77
Tapping	69-76, 83, 128-137
Teks®	29, 72, 74, 76, 91-104, 128-137

<b>Torx®:</b>	
Drive Floor	76
Pan Head Tapping	70, 130
Metric	70, 130
U.S.	76
Trim	69-75
Wood, Flat Head	76
Sealer, Automotive	837

<b>Self-Threading Nuts:</b>	
Metric	141
U.S.	155
Seam-N-Joint Sealer	837
Set Screws	79, 120
Shackles	843
Sheet Metal Plugs	195
Shims	184
Snaps	414-415
Socket Wrenches	851
Sockets, Electrical	236-257

Solder Paste	839
Solderless Terminals	204-213
Sound Dampening Pads	840
Speed Nuts®	169-179, 141-145
Split Flexible Tubing	225
Sponge Rubber	
Weatherstrip	391-394, 397
Spring Nuts	174
Spring Pins	194

<b>Springs:</b>	
Extension & Compression	190-191, 380
Truck Seat	546

Stainless Steel Fasteners	83-85
Stainless Steel Grease Fittings	283-284
Stand-Offs, Nylon	843
Stove Bolts	77
Straight Keys	196
Strain Relief Cable Connector	271
Strap, Engine Ground	228
Strap, Perforated Hanger	845
Straps, Rubber Tie Down	399
Strip-Brite Disc	68

<b>Studs, Manifold:</b>	
Metric	138
U.S.	114-115
Subaru Clips & Fasteners	770-776
Suction Gun	856
Surface Conditioning Disc	68
Suzuki Clips & Fasteners	777

<b>Switches:</b>	
Horn Button	268
Push-Pull	268
Toggle	268-270



## ALPHABETICAL INDEX

**T**

Tape:	
Electrical	230
Moulding	839
Rubber	230
Tapping Screws	69-70, 83, 128-137
Tee Rubber	398
Teenuts®	159
Test Clips	227
Terminals:	
Battery	227-229
Electrical	204-222
Thread Cutting Nuts:	
Metric	140-141
U.S.	155
Thread Cutting Screws	73
Threaded Inserts:	
Helical	166
Nutserts®	160-163
Thread Repair	164-165
Throttle Rod Clips	191
Ties, Cable (& Mounts)	272-274
Tire Valves	390
Toggle Bolts	842
Toggle Switches	268-270
Tools:	
Awls	849
Battery Tools	229-230
Bolt Extractor Kit	852
Cable Tie Tool	274
Caulking Guns	856
Circuit Tester	224-225
Clip Removal Tool	848
Cut-Off Wheel & Mandrels	854
Drill-Out® Bolt Extractor	852
Door Handle Clip Tool	400-401
Electrical Connector Separator	222
Electrical Crimping Tools	222-223
Flashlights	854
Gauges	835
Glass Shop	847-849
Grease Guns	286
Headliner Tools	847-848
Hex Key Sets	851
Hog Ring Pliers	850
Hole Punch	856
Hood Prop	850
Hose Clamp Pliers	831, 849
Hose Cutter	853
Jack Nut Installation Tool	164
Knife (Carpet)	848
Magnetic Chucks	851
Moulding Cutting Tool	853
Nutsert® Installation Tool	163
Pick (O-Ring & Seal)	849
Prep Pen	849
Razor Blade Scraper	848
Retaining Ring Pliers	190, 850
Revolving Punch	856
Rivet Guns & Nosepieces	295-296
Seat Spring Wire Bender	546
Suction Gun	856
Terminal Extractor Picks	222
Test Clips	227
Torx® Bits & Drivers	70, 131, 850
Trim Pad Removal Tool	847

**Tools continued:**

Truck Seat Spring	
Bending Tool	546, 855
Windshield Moulding Tools	847
Windshield Wiper Arm Remover	847
Toughcoat Light Bulbs	841
Torx® Bits & Drivers	70, 131, 850
Toyota Clips & Fasteners	778-808
Trailer Connectors	257
Trim Clips	409-410
Trimming Sundries & Fasteners	409-546
Truck Seat Spring Wire Bender	546, 855
Truck Seat Springs	546
Truck Wheel Hardware	156-158
Tubeless Tire Valves	390
Tubing:	
Clamps	270, 834-835
Clear Vinyl (PVC)	202, 844
Connectors:	
Brass	292
Nylon	197-200
Heat Shrink	231
Vacuum & Windshield Washer	203
Tubular Nuts	141, 169-170
Tumblers (Lock)	640
Twist-to-lock Holders	68

**U**

U-Nuts	142-145-, 172-179
Universal Moulding Clips	823
Universal Springs	191

**V**

Vacuum:	
Rubber & Vinyl Caps	197, 399
Tubing	203
Tubing Connectors	197-201
Vacuum & Windshield Washer Tubing	203
Valves, Tubeless Tire	390
Vent Window Seals	397
Vibration Dampening Pads	840
Vinyl Caps	197, 399
Vinyl Gloves	840-841
Vinyl Grommets	384, 389
Vinyl Tubing	202, 844
Volkswagen Clips & Fasteners	808-821
Volvo Clips & Fasteners	822-823

**W**

Washer Cap Type Pushnut Fasteners	844
Washer Lock Nuts:	
Metric	140
U.S.	154
Washer Type Self-Threading Nuts:	
Metric	141
U.S.	155
Washers:	
Belleville	181
Bowed Spring	181
Copper:	
Metric	146
U.S.	181
Countersunk	180, 411
Countersunk Lock	182
Fender	182
Flanged	180, 411

**Washers continued:**

Flat:	
Metric	146
U.S.	85, 180-183
Flush	180, 411
High Strength, U.S.S. & S.A.E.	181
Internal & External Combo Lock	183
Lock	146, 181-183
Metric	146
Nylon Finishing	180, 412
Nylon Flat	183
Rivet	295
S.A.E.	180-181
Split Lock, Regular & High Alloy	181
Spring Wave, Metric	146
Stainless Steel	85
Tooth (Internal, External & Countersunk)	182-183
Vibration Proof	182
Wave, Metric	146
Wrought (USS)	180
X	183
Weather-Seal Wrap	839
Weatherpack Terminals	215-216
Weatherstrip	390-391, 397
Weatherstrip for Glass	397-399
Weld Pins	839
Well Nuts®	168
Welt, Fender	410
Wheel Studs & Nuts	156-158
Windlace Cord	394
Window Channels	397-399
Window Crank Handle Clips	400-401
Window Crank Handles:	
Ford	616
General Motors	593
VW	821
Window Guides	403-404
Window Lift Motor Gear Kit	405
Window Regulator Drive Block	404
Window Regulator Gear	405
Window Reveal Moulding Clips	401-403
Window Rubber Moulding	398
Windshield Moulding Clip Tool	847
Windshield Washer & Vacuum Tubing	203
Wire:	
Bending Tool (Truck Seat Spring)	546, 855
Fusible Link Wire	226-227
Loom	225
Loom Clips & Straps	270
Mechanics Wire	845
Piano Wire	405
Primary Wire	226
Rope Clips (Nipper)	844
Wire Nuts	224
Wire Spool Racks	334
Woodruff Keys	196
Work Light	855
<b>X</b>	
X-Washers	183
"Xmas Tree" Retainers	415-489
<b>Y</b>	
Yoke Ends	194, 830

# NUMERICAL INDEX

Auveco No.	Page No.	Auveco No.	Page No.	Auveco No.	Page No.	Auveco No.	Page No.	Auveco No.	Page No.	Auveco No.	Page No.	Auveco No.	Page No.
AP448L	317	B6461	262	FP-210	384	39	287	194	288	347	290	1007	838
AP448S	317	B7225	262	FP-224	382	45	287	198	288	348	290	1008	838
AuvecoPaks	317	B7440	262	FP-232	383	46	287	200	288	349	290	1020	340
B-1	336	B7440A	262	FP-233	383	47	287	201	288	350	291	1021	340
B-2	336	B7443	262	FP-243	383	49	287	211	289	351	291	1030	340
B-3	352	B7443A	262	FP-247	384	50	287	221	289	352	291	1031	340
B24	262	B7505	262	MB-36	336	51	287	223	289	353	291	1040	340
B24A	262	B7506	262	P40-S	335	52	287	224	289	355	291	1041	340
B53	262	B7507	262	P277	335	53	287	230	289	356	291	1042	340
B57	262	B7515	262	V-875	410	68-6	370	231	289	359	291	1043	340
B67	262	B7528	262	0-Boxes	852	68-12	370	232	289	360	291	1052	338
B67A	262	B9004	264	1-900	332, 352	68-18	370	233	289	370	291	1053	338
B68	262	B9005	264	1-900L	333	68-112	370	245	289	371	291	1054	338
B89	262	B9006	264	1-901	332, 352	68-118	370	246	289	372	291	1055	338
B97	262	B9007	264	1-901 DIVIDERS	332	68-RACK	370	247	289	374	291	1092	71
B168	262	B64113	265	1-902	332, 352	69	287	262	289	385	291	1137	69
B194	262	B64132	265	1-912	332, 352	69-12	364	263	289	399	292	1146	71
B194-100	262	B64150ULT	264	1-912L	333	69-18	364	264	289	401	292	1149	69
B194A	262	B64193	265	1-912L	333	69-24	364	265	289	404	292	1183	182
B880	263	B64193ULT	265	1-916	332, 352	69-112	364	266	289	405	291	1202	410
B881	263	B64210ULT	265	1-916INSERT	332, 352	69-118	364	268	289	406	291	1256	409
B884	263	BD1S	264	1-916L	333	69-124	364	269	289	413	292	1263	71
B885	263	BD2C	264	1-920	332, 352	69-RACK	364	287	289	415	292	1265	71
B886	263	BD2R	264	1-920INSERT	332, 352	70	287	288	289	416	292	1266	71
B889	263	BD2S	264	1-920INSERT	332, 352	72	287	289	289	417	292	1267	400
B890	263	BH1	264	1-920L	333	72B-9	335	291	289	418	292	1294	182
B891	263	BH3	265	1-924	332, 352	73	287	292	289	419	292	1313	105, 109
B893	263	BH7	265	1-924INSERT	332, 352	75	287	293	289	420	292	1340	270
B894	263	BH9	265	1-924INSERT	332, 352	76	287	294	289	421	292	1341	270
B896	263	BH10	265	1-924L	333	77	287	295	289	422	292	1344	71
B899	263	BH11	265	1-932	332, 352	78	287	296	289	423	292	1346	71
B906	262	BH13	265	1-ACC	336	91	287	297	289	424	292	1347	71
B906A	262	DB-420-0	8	1-Boxes	852	96	287	298	289	425	292	1376	182
B912	262	DB-428-1	8	1-HTWD	333	101	288	299	289	426	292	1381	71
B916	262	DB-428-2	8	1-MBC	333	102	288	300	289	427	292	1382	71
B916A	262	DB-428-3	8	1-TR	334	103	288	301	289	428	292	1413	77
B921	262	DB-428-4	8	1-WSR	334	105	288	302	289	429	292	1421	69
B921A	262	DB-428-5	8	2-96	332, 352	107	288	303	289	430	292	1423	69
B1141	262	DB-428-6	8	2-600L	333	110	288	304	289	431	292	1424	69
B1156	262	DB-428-7	8	2-608	331	111	288	305	290	432	292	1432	69
B1156A	262	DB-428-8	8	2-612	331	112	288	306	290	433	292	1452	71
B1157	262	DB-428-9	8	2-612L	333	113	288	307	290	434	292	1453	71
B1157A	262	DB-428L	337	2-616L	333	114	288	308	290	435	292	1454	71
B1893	262	DFC-1	45	2-620	331	119	288	309	290	437	292	1455	71
B1895	262	DFK-1	44	2-620L	333	120	288	310	290	438	292	1456	71
B2057	262	DFK-2	45	2-624	331	121	288	311	290	439	292	1457	71
B2057A	262	DFK-3	45	2-624L	333	122	288	313	290	440	292	1458	71
B2357	262	DFT-1	45	2-Boxes	852	123	288	314	290	442	292	1459	71
B2357A	262	DFT-2	45	2-WSR	334	124	288	315	290	443	292	1460	71
B2721	262	DFT-3	45	3-60	331	125	288	316	290	455	292	1479	70
B2722	262	DFT-4	45	3-96	332, 352	126	288	317	290	456	292	1483	69
B2821	262	DFT-5	45	3-Boxes	852	127	288	318	290	457	292	1700	182
B2825	262	DFT-6	45	4-60	332, 352	128	288	319	290	464	292	1712	70
B2827	262	Dividers	336	4-96	332, 352	134	288	320	290	465	292	1717	69
B3057	262	FP-100	382	5-HCR	335	135	288	321	290	602	180, 411	1720	409
B3057A	262	FP-102	382	6-60	331	137	288	322	290	604	180, 411	1780	74
B3156	262	FP-104	382	7-SBoxes	852	150	288	325	290	612	180, 411	1781	74
B3156A	262	FP-108	382	9-D	336	151	288	326	290	614	180, 411	1787	71
B3157	262	FP-123	382	10-HCR	335	152	288	327	290	616	180, 411	1793	69
B3157A	262	FP-131	383	11	401	153	288	328	290	618	180, 411	1794	69
B3357	262	FP-132	383	18-CB	335	154	288	329	290	619	180, 411	1796	69
B3357A	262	FP-159	383	18-D	336	155	288	330	290	727	152	1797	69
B3457	262	FP-160	383	30	287	158	288	331	290	728	152	1798	69
B3457A	262	FP-163	383	31	287	159	288	332	290	729	152	1799	69
B3893	262	FP-164	384	32	287	161	288	333	290	730	152	1800	69
B4114K	262	FP-168	383	33	287	162	288	334	290	731	152	1801	69
B4157	262	FP-169	383	35	287	163	288	335	290	733	152	1802	69
B4157K	262	FP-171	384	36	287	164	288	336	290	768	182	1803	69
B5007	262	FP-178	384	37	287	168	288	337	290	807	409	1804	69
B5008	262	FP-179	384	38	287	186	288	339	290	808	409	1826	91, 95
B6411	262	FP-183	384	193	288	187	288	341	290	1001	837	1863	77
B6413	262	FP-188	384	194	288	189	288	342	290	1002	837	1877	77
B6418	262	FP-193	384	194	288	192	288	343	290	1005	837	1896	170
B6438	262	FP-194	384	194	288	193	288	344	290	1006	837	1898	170



## NUMERICAL INDEX

Auveco No.	Page No.	Auveco No.	Page No.	Auveco No.	Page No.	Auveco No.	Page No.	Auveco No.	Page No.	Auveco No.	Page No.	Auveco No.	Page No.
1899	170	2452	184	2712	69	3078	71	3414	86	3713	77	3963	846
1900	170	2453	184	2713	69	3079	71	3415	86	3715	77	3964	846
1903	171	2472	106, 110	2716	69	3080	71	3432	86	3716	77	3965	846
1905	171	2485	74	2717	69	3081	71	3433	86	3717	77	3966	846
1906	171	2487	74	2718	69	3082	71	3434	86	3718	77	3967	846
1907	173	2515	180, 411	2720	69	3083	71	3435	86	3719	77	3968	846
1912	170	2530	78	2722	69	3084	71	3438	86	3720	77	3969	846
1913	173	2531	78	2724	69	3085	71	3465	72	3722	77	3971	846
1932	69	2532	78	2726	69	3086	71	3466	72	3724	77	3975	154
1933	69	2533	78	2727	69	3087	71	3467	72	3741	154	3984	180
1934	77	2534	78	2728	69	3088	71	3468	72	3743	154	3985	180
1935	71	2535	78	2729	69	3089	71	3469	180, 411	3750	195	3986	180
1936	71	2536	78	2730	69	3090	71	3470	180, 411	3751	195	3987	180
1937	71	2537	78	2731	69	3091	71	3471	180, 411	3752	195	3988	180
1939	71	2538	78	2734	69	3092	71	3472	180, 411	3753	195	3989	180
1940	71	2539	78	2735	69	3093	71	3484	69	3754	195	3990	180
1942	71	2540	78	2736	70	3099	86	3492	153	3755	195	3991	180
1943	71	2541	78	2744	824	3100	86	3493	153	3756	195	3992	180
1946	70	2542	78	2751	72	3102	86	3494	153	3758	270	3993	180
2007	182	2543	78	2752	824	3135	400	3495	153	3770	173	4155	395
2008	182	2544	78	2753	77, 88	3137	169	3496	153	3776	169	4188	394
2012	74	2545	78	2769	154	3138	171	3497	153	3777	169	4204	396
2024	69	2546	78	2771	72	3144	154	3498	153	3793	170	4233	395
2027	69	2548	78	2772	72	3155	184	3499	153	3796	172	4235	394
2028	92, 99	2550	78	2773	72	3156	184	3500	153	3797	173	4236	396
2046	69	2554	154	2774	72	3165	189	3502	193	3798	154	4237	394
2057	173	2555	154	2775	72	3166	189	3503	193	3824	189	4240	396
2089	170	2556	154	2789	824	3167	189	3504	193	3854	77	4242	394
2091	170	2557	154	2802	69	3168	193	3505	193	3859	77	4243	394
2092	170	2558	154	2804	70	3178	548	3506	193	3868	152	4244	395
2098	171	2560	154	2805	91, 95	3182	105, 109	3508	193	3877	196	4246	394
2099	171	2561	154	2806	91, 96	3183	105, 109	3509	193	3878	196	4248	394
2100	171	2562	154	2807	70	3184	105, 109	3511	193	3879	196	4249	395
2102	171	2571	69	2808	71	3186	229	3512	193	3880	196	4250	395
2103	171	2572	69	2809	75	3205	69	3513	193	3881	196	4258	395
2105	171	2574	69	2810	70	3207	69	3515	193	3882	196	4260	394
2107	74	2575	69	2818	824	3209	548	3519	193	3883	196	4264	395
2109	74	2578	69	2850	411	3211	71	3520	193	3884	196	4265	394
2110	74	2579	69	2895	155	3212	74	3521	193	3885	196	4273	395
2178	92, 99	2580	69	2896	155	3214	74	3522	193	3886	196	4280	394
2209	88	2581	69	2897	155	3215	74	3524	193	3887	196	4281	396
2227	182	2582	69	2943	567, 824	3216	74	3526	193	3888	196	4305	386
2262	159	2583	69	2967	75	3217	74	3537	72	3889	196	4306	386
2266	74	2585	69	2968	75	3219	74	3538	72	3890	196	4307	386
2267	74	2586	69	2969	75	3220	74	3539	72	3891	196	4308	386
2268	74	2595	169	2973	75	3249	153	3541	152	3892	196	4309	386
2269	74	2597	180, 411	2974	75	3250	153	3542	152	3893	196	4310	386
2272	409, 634	2598	193, 400	2976	75	3367	75	3543	152	3894	196	4311	386
2288	400	2604	75	2978	75	3368	75	3544	152	3895	196	4312	386
2293	173	2605	75	2979	75	3369	75	3545	152	3896	196	4313	386
2299	77	2611	169	2980	75	3373	75	3546	152	3929	180	4314	386
2303	173	2619	824	2981	75	3374	73, 75	3547	152	3930	180	4315	386
2309	409	2625	111	2988	75	3375	75	3548	152	3931	180	4316	386
2310	409	2628	402	2989	75	3376	73, 75	3549	152	3932	180	4317	386
2330	75	2632	69	2991	75	3378	75	3550	152	3933	180	4318	386
2333	182	2633	69	2994	75	3379	75	3553	182	3935	180	4319	386
2346	172	2656	69	2996	75	3380	75	3554	182	3937	846	4320	386
2354	77	2657	69	2999	184	3381	75	3556	182	3938	846	4321	386
2358	69	2661	69	3000	184	3382	75	3609	191	3939	846	4322	386
2359	69	2665	69	3020	71	3383	75	3610	191	3941	846	4323	386
2360	69	2666	69	3022	71	3385	75	3611	191	3942	846	4324	386
2361	69	2672	189, 411	3028	71	3386	75	3612	191	3944	846	4347	386
2362	69	2688	77, 88	3032	71	3387	75	3613	191	3945	846	4348	386
2364	71	2698	69	3062	69	3388	75	3614	191	3946	846	4349	386
2365	71	2699	69	3063	69	3389	75	3615	77, 88	3949	846	4350	386
2366	71	2700	69	3068	69	3390	75	3616	174	3950	846	4351	386
2367	71	2702	69	3069	69	3392	75	3617	413	3952	846	4352	386
2369	75	2704	69	3071	71	3393	75	3620	442, 475	3953	846	4353	386
2370	75	2705	69	3072	71	3394	75	3628	189	3956	846	4354	386
2385	409	2706	69	3073	71	3400	155	3639	442, 475	3957	846	4355	386
2389	74	2707	69	3074	71	3401	155	3682	112	3958	846	4356	386
2420	173	2709	69	3075	71	3403	155	3690	272	3960	846	4357	395
2422	173	2710	69	3076	71	3404	155	3711	77	3961	846	4369	395
2426	171	2711	69	3077	71	3405	155	3712	77	3962	846	4408	389

# NUMERICAL INDEX

Auveco No.	Page No.	Auveco No.	Page No.	Auveco No.	Page No.	Auveco No.	Page No.	Auveco No.	Page No.	Auveco No.	Page No.	Auveco No.	Page No.
4410	389	4747	392	5077	184	5376	79	5472	81	5648	70	6062	343, 351
4411	389	4749	393	5096	184	5377	79	5473	81	5649	70	6065	343, 350
4413	389	4750	393	5097	184	5378	79	5474	81	5650	70	6070	343, 346
4414	389	4800	391	5167	154	5379	79	5475	81	5651	70	6073	343, 345
4415	389	4801	391	5170	174	5380	79	5476	81	5653	70	6085	343, 348
4417	389	4802	391	5195	169	5381	79	5477	81	5654	70	6086	343, 347
4418	389	4803	391	5196	170	5382	79	5478	81	5655	70	6112	343, 347
4419	389	4804	391	5197	173	5383	79	5479	81	5656	70	6116	343, 348
4420	389	4805	391	5219	255	5384	79	5480	81	5660	70	6123	343, 347
4421	389	4806	391	5220	255	5385	79	5481	81	5661	70	6124	343, 350
4422	389	4807	391	5221	255	5386	79	5482	81	5672	70	6125	343, 350
4423	389	4808	391	5225	256	5387	79	5483	81	5697	77	6128	343, 349
4425	389	4809	391	5226	256	5388	79	5484	81	5700	78	6133	343, 351
4426	389	4810	391	5228	112	5389	79	5485	81	5702	78	6144	343, 345
4428	389	4811	391	5238	86	5390	79	5486	81	5704	78	6158	343, 348
4429	389	4812	391	5239	86	5391	79	5487	81	5711	77, 88	6160	343, 345
4430	389	4813	391	5242	86	5392	79	5488	81	5713	77, 88	6162	343, 350
4431	389	4850	391	5243	86	5393	79	5489	81	5714	86	6164	343, 346
4432	389	4851	391	5246	86	5394	79	5490	81	5717	181	6166	343, 350
4433	389	4852	391	5249	182	5395	79	5491	81	5718	181	6167	343, 351
4434	389	4853	391	5250	182	5396	79	5492	81	5719	181	6168	343, 351
4435	389	4854	391	5251	182	5398	79	5493	81	5720	181	6172	343, 347
4436	389	4855	391	5252	182	5399	79	5494	81	5721	181	6173	343, 349
4439	197, 399	4856	391	5253	182	5400	79	5495	81	5722	181	6175	343, 349
4440	197, 399	4857	391	5254	182	5401	79	5497	81	5723	181	6176	343, 351
4441	395	4858	391	5255	182	5402	79	5499	81	5724	181	6178	343, 349
4446	395	4859	391	5256	182	5403	79	5500	81	5748	293	6182	343, 344
4447	395	4860	391	5257	182	5404	79	5501	81	5749	293	6186	343, 346
4448	399	4861	391	5258	182	5405	79	5505	81	5750	293	6187	343, 349
4449	399	5000	211	5259	182	5406	79	5510	81	5751	293	6501	353, 354
4450	399	5002	211	5260	182	5407	79	5512	81	5752	293	6502	353, 357
4451	399	5003	211	5261	182	5408	79	5513	81	5753	293	6503	353, 355
4453	203	5005	211	5262	182	5409	79	5514	81	5754	294	6504	353, 358
4454	203	5006	211	5263	182	5410	79	5516	81	5755	294	6505	353, 361
4456	203	5007	212	5264	182	5411	79	5524	81	5759	73	6506	353, 358
4457	203	5008	212	5265	182	5412	79	5526	81	5764	73	6507	353, 357
4459	203	5009	212	5266	182	5413	79	5527	81	5766	73	6508	353, 358
4460	203	5010	212	5267	182	5414	79, 851	5528	81	5767	73	6509	353, 359
4462	203	5014	211	5268	182	5415	79, 851	5530	81	5768	73	6510	353, 359
4463	203	5015	211	5270	182	5434	81	5533	81	5769	73	6511	353, 360
4464	203	5021	205	5271	182	5435	81	5537	81	5773	73	6513	353, 356
4465	203	5023	205	5272	182	5436	81	5538	81	5774	73	6514	353, 355
4466	203	5024	205	5274	182	5438	81	5539	81	5775	73	6517	353, 362
4467	203	5026	205	5278	106, 107	5439	81	5542	81	5776	73	6519	353, 361
4468	203	5027	205	5290	72	5440	81	5547	81	5778	73	6520	353, 361
4473	396	5028	205	5291	72	5441	81	5550	81	5781	73	6522	353, 361
4474	396	5029	205	5292	72	5442	81	5551	81	5782	73	6523	353, 359
4511	398	5030	205	5298	72	5443	81	5553	81	5783	73	6524	353, 357
4512	398	5031	205	5301	72	5444	81	5563	170	5784	73	6525	353, 361
4513	398	5032	205	5307	72	5445	81	5571	172	5786	73	6530	353, 354
4515	398	5033	205	5329	74	5446	81	5576	173	5787	73	6532	353, 356
4530	398	5034	205	5330	74	5447	81	5586	174	5788	548	6533	353, 354
4531	398	5035	205	5331	74	5448	81	5589	174	5789	548	6534	353, 360
4581	398	5036	205	5332	74	5449	81	5592	442, 475	5791	204	6535	353, 358
4588	398	5037	206	5347	833	5450	81	5596	154	5792	204	6536	353, 355
4654	394	5038	205	5348	833	5451	81	5600	189	5793	204	6537	353, 362
4655	394	5040	205	5349	833	5452	81	5601	189	5794	229	6538	353, 357
4656	394	5041	206	5350	833	5453	81	5602	189	5796	229	6539	353, 354
4670	398	5044	211	5351	833	5454	81	5603	189	5836	172	6540	353, 356
4671	398	5045	211	5352	833	5455	81	5616	69	5854	169	6541	353, 355
4675	392	5046	212	5354	832	5456	81	5617	69	5879	272	6542	353, 362
4688	398	5047	205	5357	832	5457	81	5618	69	5885	105, 109	6543	353, 360
4703	392	5048	205	5358	832	5459	81	5619	71	5889	825	6544	353, 359
4707	392	5049	206	5365	79	5461	81	5621	71	5908	105, 107	6545	353, 362
4731	392	5056	206	5366	79	5462	81	5623	71	5909	105, 107	6546	353, 362
4736	394	5062	208	5367	79	5463	81	5625	71	5910	106, 108	6547	353, 363
4737	394	5063	208	5368	79	5464	81	5626	71	5961	410	6548	353, 362
4738	394	5066	211	5369	79	5465	81	5629	71	6003	343, 344	6549	353, 362
4740	393	5067	207	5370	79	5466	81	5630	71	6004	343, 344	6550	353, 363
4742	393	5068	207	5371	79	5467	81	5632	71	6007	343, 346	6551	353, 363
4743	393	5072	205	5372	79	5468	81	5633	71	6011	343, 345	6552	353, 363
4744	393	5074	184	5373	79	5469	81	5634	71	6038	343, 344	6553	353, 360
4745	392	5075	184	5374	79	5470	81	5646	70	6043	343, 346	6554	353, 356
4746	393	5076	184	5375	79	5471	81	5647	70	6051	343, 348	6555	353, 363



## NUMERICAL INDEX

Auveco No.	Page No.	Auveco No.	Page No.	Auveco No.	Page No.	Auveco No.	Page No.	Auveco No.	Page No.	Auveco No.	Page No.	Auveco No.	Page No.
6556	353, 362	6822	370, 378	6941	364, 369	8083	69	8456	81	8678	187	8862	154
6557	353, 361	6825	370, 376	6942	364, 367	8096	81	8477	193	8680	187	8863	154
6558	353, 360	6826	370, 375	7137	180, 411	8097	81	8478	193	8682	187	8864	154
6600BHM	324	6827	370, 377	7138	180, 411	8104	81	8479	193	8683	187	8865	154
6601BHM	324	6829	370, 379	7143	180, 411	8105	81	8480	193	8688	187	8867	154
6602BHM	324	6830	370, 375	7145	180, 411	8107	81	8481	193	8689	187	8868	154
6603BHM	324	6831	370, 375	7147	180, 411	8206	409	8482	193	8690	187	8869	154
6604BHM	324	6834	370, 380	7148	180, 411	8242	112	8483	193	8691	187	8871	293
6605BHM	325	6835	370, 378	7342	411	8249	106, 107	8484	193	8692	187	8872	293
6606BHM	325	6836	370, 376	7343	411	8250	106, 109	8485	193	8693	187	8873	293
6607BHM	325	6837	370, 379	7344	411	8272	272	8486	193	8694	187	8874	293
6608BHM	325	6838	370, 380	7347	411	8273	272	8487	193	8695	187	8875	293
6609BHM	325	6839	370, 380	7348	411	8277	275	8488	193	8696	187	8877	293
6610BHM	325	6840	370, 377	7349	411	8278	275	8489	193	8697	187	8879	293
6611BHM	325	6841	370, 377	7350	411	8279	275	8490	193	8698	187	8880	293
6612BHM	325	6842	370, 377	7409	415	8281	275	8491	193	8699	187	8881	293
6613BHM	325	6843	370, 376	7417	415	8285	282	8492	193	8700	187	8882	293
6614BHM	326	6845	370, 378	7419	415	8286	282	8493	193	8701	187	8883	293
6615BHM	326	6846	370, 378	7432	415	8288	282	8494	193	8702	187	8884	293
6616BHM	326	6847	370, 378	7578	410	8289	282	8495	193	8703	187	8886	293
6617BHM	326	6848	370, 371	7595	410	8290	293	8496	193	8704	187	8887	293
6618BHM	326	6850	370, 371	7613	180, 411	8291	293	8497	193	8705	187	8888	293
6619BHM	326	6851	370, 371	7615	180, 411	8292	293	8498	193	8706	187	8889	293
6620BHM	326	6852	370, 372	7616	180, 411	8293	293	8499	193	8707	187	8892	293
6621BHM	330	6853	370, 373	7618	180, 411	8294	294	8500	193	8708	187	8893	293
6622BHM	329	6854	370, 373	7624	180, 411	8295	294	8501	193	8709	187	8894	293
6623BHM	329	6856	370, 374	7625	180, 411	8296	294	8502	193	8710	187	8895	293
6624BHM	329	6857	370, 374	7644	410	8297	294	8503	193	8711	187	8896	293
6625BHM	330	6858	370, 373	7657	850	8298	294	8506	193	8712	187	8897	293
6626BHM	330	6859	370, 376	7658	850	8299	294	8507	193	8715	187	8898	293
6627BHM	330	6861	370, 375	7672	847	8300	294	8508	193	8719	411, 877	8899	293
6628BHM	328	6862	370, 375	7677	414	8301	294	8509	193	8742	156	8900	293
6629BHM	327	6863	370, 375	7678	414	8302	293	8511	193	8744	156	8901	293
6630BHM	327	6864	370, 379	7679	414	8303	293	8516	193	8746	156	8902	293
6631BHM	327	6865	370, 379	7680	414	8304	293	8518	193	8750	237	8903	293
6632BHM	329	6866	370, 378	7682	414	8305	293	8521	193	8754	237	8905	294
6633BHM	329	6867	370, 376	7688	414	8306	294	8530	193	8755	236	8906	294
6634BHM	326	6868	370, 374	7690	414	8307	294	8545	169	8756	237	8908	294
6635BHM	327	6869	370, 374	7691	414	8308	294	8546	169	8759	236	8909	294
6637BHM	328	6870	370, 379	7692	414	8309	294	8550	272	8761	244	8911	294
6638BHM	329	6871	370, 379	7707	411	8310	294	8552	86	8763	255	8912	294
6639BHM	329	6901	364, 367	7711	223	8311	294	8557	86	8764	256	8913	294
6640BHM	330	6902	364, 367	7767	851	8312	294	8562	86	8768	256	8914	294
6641BHM	328	6903	364, 367	7771	410	8313	294	8578	170	8769	257	8915	294
6642BHM	327	6904	364, 367	7772	410	8337	172	8581	825	8770	256	8917	294
6643BHM	328	6905	364, 367	7773	410	8341	173	8583	401	8772	227	8918	294
6644BHM	328	6906	364, 367	7778	847	8359	176	8588	78	8773	227	8919	294
6645BHM	328	6907	364, 367	7909	190, 850	8372	176	8589	78	8774	216	8920	294
6646BHM	330	6908	364, 368	7910	190, 850	8375	176	8590	78	8775	216	8922	294
6647BHM	331	6910	364, 369	7914	847	8377	176	8594	78	8776	216	8923	294
6648BHM	331	6911	364, 368	7915	295	8385	825	8605	180	8777	217	8924	294
6649BHM	326	6912	364, 369	7965	119, 851	8386	825	8606	180	8781	207	8925	294
6650BHM	324	6913	364, 369	7976	851	8398	825	8607	180	8788	208	8926	294
6699BHM	327	6914	364, 367	7977	79, 851	8399	825	8608	180	8814	177	8927	294
6801	370, 378	6915	364, 369	7978	79, 851	8400	825	8609	180	8824	189	8928	294
6802	370, 378	6916	364, 369	7981	295, 305	8418	112	8610	180	8825	189	8929	294
6803	370, 378	6917	364, 368	7983	295	8419	616	8611	180	8826	189	8930	294
6804	370, 379	6918	364, 369	7984	295	8427	105, 110	8612	180	8827	189	8931	294
6805	370, 379	6919	364, 367	7985	295	8435	112	8613	180	8828	189	8932	294
6806	370, 377	6920	364, 365	7996	230	8437	73	8621	180	8829	189	8933	294
6807	370, 379	6921	364, 365	7999	847	8438	73	8623	87	8830	189	8934	294
6808	370, 372	6923	364, 365	8003	229	8439	73	8624	87	8831	189	8935	294
6809	370, 378	6924	364, 366	8009	208	8441	73	8625	87	8832	189	8936	294
6810	370, 372	6929	364, 365	8029	78	8442	73	8626	86	8833	189	8937	294
6811	370, 372	6930	364, 366	8030	78	8443	73	8627	86	8834	189	8938	294
6812	370, 371	6931	364, 366	8031	78	8444	73	8649	181	8835	189	8939	294
6813	370, 372	6933	364, 366	8033	78	8445	184	8650	181	8836	189	8940	294
6814	370, 372	6934	364, 367	8035	78	8447	825	8659	152	8837	189	8941	403
6815	370, 374	6935	364, 368	8036	78	8448	825	8660	152	8843	810, 825	8942	549
6816	370, 374	6936	364, 368	8044	69	8449	81	8661	152	8847	83, 90	8944	91, 94
6817	370, 373	6937	364, 368	8050	69	8450	81	8662	152	8853	437, 475	8954	112
6818	370, 375	6938	364, 369	8056	69	8453	81	8663	152	8855	155	8963	846
6820	370, 376	6939	364, 369	8062	69	8454	81	8665	411, 877	8858	154	8971	846
6821	370, 377	6940	364, 369	8068	69	8455	81	8677	187	8861	154	8981	194

# NUMERICAL INDEX

Auveco No.	Page No.	Auveco No.	Page No.	Auveco No.	Page No.	Auveco No.	Page No.	Auveco No.	Page No.	Auveco No.	Page No.	Auveco No.	Page No.
8983	194	9112	191	9247	834	9407	83	9572	76	9705	114	10058	270
8985	194	9114	191	9248	834	9408	83	9575	76	9709	114	10059	270
8987	194	9115	272	9249	834	9409	83	9576	76	9711	114	10064	174
8988	194	9118	82	9250	834	9410	83	9577	76	9712	114	10065	174
8989	194	9119	82	9251	834	9411	83	9578	76	9715	114	10066	174
8991	194	9120	82	9252	834	9412	83	9581	76	9727	114	10067	174
8992	194	9121	82	9257	283	9416	410	9582	76	9728	114	10068	87
8993	194	9122	82	9258	283	9417	410	9584	832	9729	114	10073	169
8994	194	9124	82	9259	283	9433	193	9585	832	9731	114	10080	631
8995	194	9125	82	9260	283	9435	193	9586	832	9732	114	10084	88, 89
8996	194	9126	82	9261	283	9436	193	9587	832	9739	114	10085	154
8997	194	9127	82	9262	283	9438	193	9588	832	9744	114	10086	154
8998	194	9128	82	9264	284	9440	193	9589	832	9745	114	10087	154
8999	194	9129	82	9265	284	9441	193	9590	832	9749	401	10090	549
9000	194	9130	82	9266	284	9443	193	9591	832	9756	88, 90	10101	200
9001	194	9131	82	9267	284	9444	193	9592	832	9757	88, 89	10102	200
9002	194	9132	82	9275	401	9446	193	9593	832	9759	196	10103	200
9003	194	9133	82	9278	287	9447	193	9594	832	9794	196	10104	200
9004	194	9134	82	9279	287	9477	566	9595	832	9795	196	10105	200
9005	194	9135	82	9282	287	9480	88, 89	9596	832	9796	196	10106	200
9006	194	9136	82	9283	287	9481	213	9597	832	9800	196	10107	200
9007	194	9137	82	9284	287	9482	79	9598	832	9801	196	10108	200
9008	194	9138	82	9285	287	9483	79	9599	833	9802	196	10109	200
9009	194	9139	82	9288	195	9484	79	9600	833	9814	414	10110	200
9010	194	9140	82	9289	195	9485	79	9601	833	9825	75	10116	187
9011	194	9141	82	9290	195	9486	79	9603	106, 108	9829	549	10117	187
9012	194	9142	82	9291	195	9487	79	9604	74	9846	154	10118	187
9013	194	9143	82	9292	195	9489	79	9605	74	9850	412, 555	10120	187
9015	194	9144	82	9293	195	9490	79	9606	74	9851	548	10121	187
9016	194	9145	82	9297	154	9491	79	9607	74	9853	86	10122	187
9017	194	9146	82	9298	154	9492	79	9608	74	9854	86	10123	187
9018	194	9147	82	9299	154	9493	79	9609	74	9855	86	10124	187
9019	194	9148	82	9300	153	9494	79	9610	74	9862	595	10125	187
9021	194	9149	82	9301	153	9498	79	9611	74	9863	91, 94	10126	187
9022	194	9150	82	9302	153	9499	79	9612	74	9864	270	10127	187
9023	194	9151	82	9303	153	9500	79	9613	74	9869	830	10128	187
9024	194	9152	82	9304	153	9501	79	9614	74	9877	91, 94, 412	10129	187
9025	194	9153	82	9305	153	9502	79	9615	74	9879	174	10130	189
9026	194	9154	82	9306	153	9507	79	9616	74	9880	174	10131	189
9027	194	9155	82	9307	153	9509	79	9617	74	9881	174	10132	189
9028	194	9156	82	9308	153	9510	79	9620	74	9882	402	10133	189
9029	194	9157	82	9309	153	9520	81	9625	172	9883	236, 244	10134	189
9030	194	9158	82	9310	153	9521	81	9630	181	9884	243	10135	189
9031	194	9159	82	9311	153	9522	81	9633	401	9885	243	10162	69
9033	194	9160	82	9312	153	9523	81	9637	274	9886	401	10163	69
9034	194	9161	82	9324	832	9524	81	9639	401	9890	193	10164	69
9035	194	9162	82	9342	413	9525	81	9643	293	9892	193	10165	69
9036	194	9163	82	9353	402	9526	81	9644	293	9894	191	10166	69
9037	194	9164	82	9354	87	9528	81	9647	293	9900	256	10167	69
9038	194	9165	82	9355	87	9529	81	9648	293	9901	256	10168	69
9039	194	9167	82	9356	87	9535	152	9667	114	9905	236, 253	10169	69
9040	194	9169	82	9357	833	9536	152	9668	114	9916	243	10170	69
9042	194	9170	82	9358	833	9537	152	9669	114	9948	227	10171	69
9043	194	9171	82	9361	409	9538	152	9670	114	9965	567, 824	10172	70
9044	194	9172	82	9367	586	9539	152	9673	114	9994	842	10173	70
9045	194	9174	82	9377	616, 764	9540	152	9674	114	10005	842	10174	70
9046	194	9177	82	9381	835	9541	152	9675	114	10006	842	10175	70
9048	194	9184	82	9382	835	9542	152	9676	114	10008	842	10176	70
9049	194	9186	82	9383	835	9543	152	9677	114	10009	842	10177	70
9050	194	9188	82	9384	835	9544	152	9679	114	10010	842	10178	70
9051	194	9191	82	9385	835	9545	152	9680	114	10011	842	10179	70
9052	204	9192	82	9386	835	9546	152	9681	114	10012	842	10180	71
9055	204	9193	82	9387	835	9547	152	9683	114	10013	842	10181	71
9056	204	9194	82	9388	835	9548	152	9684	114	10014	842	10182	71
9057	204	9199	82	9389	835	9555	76	9686	114	10018	842	10183	71
9058	204	9201	82	9391	835	9556	76	9687	114	10036	153	10184	390
9059	204	9203	82	9399	83	9557	76	9688	114	10048	176	10191	390
9060	204	9208	82	9400	83	9564	76	9689	114	10050	176	10192	390
9064	204	9210	82	9401	83	9565	76	9690	114	10051	176	10217	274
9065	205	9212	82	9402	83	9566	76	9695	114	10052	177	10218	274
9069	550	9219	82	9403	83	9568	76	9696	114	10053	176	10220	554
9091	75	9224	82	9404	83	9569	76	9699	114	10054	177	10221	832
9100	75	9229	91, 95	9405	83	9570	76	9701	114	10055	177	10222	257
9110	191	9246	834	9406	83	9571	76	9702	114	10057	270	10223	257



# NUMERICAL INDEX

Auveco No.	Page No.	Auveco No.	Page No.	Auveco No.	Page No.	Auveco No.	Page No.	Auveco No.	Page No.	Auveco No.	Page No.	Auveco No.	Page No.
10231	195	10438	116	10575	138	10744	437, 475	11105	294, 305	11321	200	11502	147, 186
10232	195	10439	116	10576	138	10759	547	11106	294, 305	11324	159	11503	147, 186
10242	401	10440	116	10577	146	10760	616	11109	88, 90	11325	159	11505	147, 186
10243	401	10441	116	10578	146	10764	154	11110	88, 90	11326	159	11506	147, 186
10262	587, 614, 630, 634	10459	116	10579	146	10773	154	11118	566, 413	11327	159	11507	147, 186
10264	162	10460	116	10580	146	10780	409	11119	566, 413	11328	159	11513	147, 186
10265	162	10464	116	10581	146	10782	257	11120	416, 475	11331	159	11514	147, 186
10266	162	10478	116	10582	146	10783	257	11129	416, 475	11332	159	11515	147, 186
10267	162	10488	116	10583	146	10788	194, 830	11130	434, 475	11345	402	11516	147, 186
10268	162	10501	117	10584	146	10789	194, 830	11136	441, 475	11347	421, 475	11517	147, 186
10269	162	10502	117	10585	146	10790	194, 830	11138	554	11349	471, 475	11518	147, 186
10270	162	10504	117	10586	146	10791	194, 830	11146	425, 475	11350	433, 475	11519	147, 186
10271	162	10505	117	10587	146	10792	194, 830	11152	401, 402	11351	429, 475	11520	147, 186
10272	162	10506	117	10588	146	10793	194, 830	11154	237	11352	583	11521	147, 186
10273	162	10507	117	10589	146	10808	228	11156	237	11354	620	11523	147, 186
10274	162	10508	117	10590	146	10823	88, 89	11157	237, 253	11360	227	11527	147, 186
10275	162	10509	117	10591	146	10830	176	11166	236, 244	11361	227	11602	208
10276	162	10510	117	10592	146	10831	425, 475	11179	154	11362	227	11604	208
10277	162	10511	117	10593	146	10832	425, 475	11180	154	11363	227	11605	207
10278	162	10512	117	10595	146	10837	611	11181	154	11364	227	11606	207
10279	162	10513	117	10596	146	10843	400	11182	154	11365	227	11612	418, 475
10280	162	10514	117	10598	835	10845	119	11183	154	11366	227	11614	86
10282	162	10515	117	10599	835	10846	119	11184	154	11367	227	11615	86
10283	162	10516	117	10600	835	10848	119	11187	184	11368	112	11618	232
10284	162	10517	117	10601	835	10851	119	11220	201	11369	106, 109	11620	302
10285	162	10519	117	10602	835	10853	119	11224	201	11370	106, 110	11621	304
10286	162	10520	117	10603	835	10854	119	11226	201	11371	616	11625	145, 177
10288	162	10521	117	10604	835	10855	119	11228	200	11392	227	11626	145, 178
10289	162	10522	117	10605	835	10858	119	11229	200	11404	115,	11627	145, 179
10290	162	10523	117	10606	835	10859	119	11243	547		137, 821	11628	145, 179
10305	550,	10524	117	10607	835	10861	119	11244	547	11405	208	11629	145, 179
	595, 616	10525	117	10608	834	10863	119	11245	547	11406	409	11630	145, 179
10318	556	10526	117	10609	834	10864	119	11246	547	11419	199	11631	145, 179
10319	208, 213	10527	117	10610	834	10865	119	11255	119	11424	550	11633	122, 126
10322	808	10528	117	10611	834	10866	119	11257	119	11425	555	11638	122, 126
10330	549	10529	117	10612	834	10868	119	11259	119	11429	173	11639	122, 126
10332	428, 475	10530	117	10613	834	10870	119	11262	119	11434	257	11640	122, 127
10336	299	10532	117	10614	834	10872	119	11263	119	11435	257	11641	122, 127
10337	299	10534	117	10615	834	10873	119	11264	119	11436	243	11644	140
10345	299	10535	117	10617	555	10875	119	11265	119	11437	252, 254	11645	140
10346	299	10536	117	10621	471, 475	10878	119	11266	119	11438	254	11653	616
10351	299	10537	117	10622	402	10885	119	11267	119	11439	256	11654	616
10352	299	10538	117	10630	402	10898	119	11268	119	11440	242, 254	11655	548
10357	299	10539	117	10631	402	10960	119	11269	119	11441	236, 244	11656	548
10358	299	10540	117	10632	412	10961	119	11270	119	11442	243	11657	547
10359	299	10541	118	10642	91, 94	10970	119	11271	119	11443	243	11660	594
10362	88, 89	10542	118	10643	846	10972	119	11273	119	11444	242	11661	594
10364	94, 104	10543	118	10644	846	11006	120	11274	119	11445	252	11665	547
10365	552	10544	118	10649	273	11024	120	11275	119	11446	237	11667	548
10368	201	10545	118	10652	72	11032	120	11276	119	11448	72	11671	456, 475
10374	154	10546	118	10653	72	11049	138	11277	138	11449	72	11672	471, 475
10375	154	10547	118	10654	72	11051	138	11278	138	11450	72	11673	429, 475
10378	224	10548	118	10655	87	11053	138	11279	138	11451	72	11675	420, 475
10379	224	10549	118	10656	87	11055	138	11280	138	11452	72	11677	472, 475
10380	224	10550	118	10657	87	11057	138	11288	554	11453	72	11678	471, 475
10381	224	10551	118	10658	304	11059	138	11292	172	11454	72	11679	421, 475
10382	224	10553	149	10666	172	11061	88, 90	11293	169	11455	72	11680	418, 475
10384	224	10554	149	10697	198	11066	401	11294	73	11456	72	11691	550
10385	213	10555	149	10701	401	11067	401	11295	73	11457	72	11697	634
10386	213	10557	149	10714	94, 104	11083	229	11296	73	11467	229	11699	571, 506,
10390	191	10558	149	10719	208	11084	69	11297	73	11470	547, 634		624, 534
10391	192	10559	149	10720	208	11086	69	11298	399	11475	237	11702	491,
10392	192	10560	149	10724	211	11087	69	11299	399	11476	237		534, 606
10393	192	10562	149	10729	159	11088	69	11310	160	11485	412, 554	11704	505,
10394	192	10564	149	10730	159	11089	69	11311	160	11486	147, 185		534, 624
10395	192	10566	149	10731	159	11090	69	11312	160	11488	147, 185	11705	500,
10396	192	10567	149	10732	159	11091	69	11313	160	11489	147, 185		534, 606
10397	192	10568	149	10733	155	11092	69	11314	160	11490	147, 185	11706	514,
10398	192	10569	138	10737	194, 830	11097	148, 285	11315	160	11491	147, 185		534, 606
10427	116	10570	138	10738	194, 830	11098	148, 285	11316	160	11492	147, 185	11708	139
10431	116	10571	138	10739	194, 830	11099	148, 285	11317	160	11494	147, 185	11709	139
10436	116	10572	138	10740	194, 830	11100	148, 285	11318	160	11495	147, 185	11717	555
10437	116	10573	138	10741	194, 830	11101	148, 285	11319	160	11500	147, 186	11718	547
		10574	138	10742	194, 830	11104	294, 305	11320	88, 90	11501	147, 186	11719	112

# NUMERICAL INDEX

Auveco No.	Page No.	Auveco No.	Page No.	Auveco No.	Page No.	Auveco No.	Page No.	Auveco No.	Page No.	Auveco No.	Page No.	Auveco No.	Page No.
11721	417, 475	11877	149	12028	826	12144	205	12316	593	12442	226	12617	156
11729	229	11878	149	12029	826	12146	208	12322	121, 124	12443	226	12621	555
11733	193	11879	149	12030	827	12147	204	12323	121, 125	12444	226	12622	610
11736	193	11881	149	12031	827	12148	204	12324	121, 123	12445	226	12627	227
11738	198	11884	149	12032	827	12149	204	12327	122, 127	12447	226	12628	227
11740	152	11886	149	12034	827	12150	204	12335	121, 125	12448	226	12629	227
11741	152	11888	149	12035	827	12151	204	12336	122, 126	12470	616	12630	212
11742	152	11895	149	12036	827	12152	204	12339	94, 103, 130, 136	12472	70, 131, 850, 851	12631	212
11743	152	11896	149	12037	827	12153	204					12635	808
11744	152	11899	149	12038	827	12154	207	12343	122, 127	12474	850	12637	822
11746	195	11904	74	12039	829	12155	207	12348	122, 127	12475	850	12642	757
11747	195	11905	74	12040	829	12156	207	12350	94, 104, 130, 137	12477	850	12652	315
11748	195	11906	74	12041	829	12157	207			12485	826	12653	303
11749	195	11908	74	12042	829	12158	208	12351	93, 102, 130, 136	12486	826	12654	314
11761	851	11909	74	12044	829	12159	207			12487	826	12655	303
11762	851	11910	74	12045	829	12160	121, 124	12354	94, 103, 130, 136	12488	826	12656	306
11768	172	11911	74	12047	828	12161	207, 213			12491	827	12657	312
11770	87	11912	74	12049	828	12162	204	12359	232	12492	827	12658	304
11771	87	11913	74	12050	828	12163	204	12361	274	12517	80	12666	145, 178
11774	471, 475	11914	74	12057	93, 102, 130, 135	12164	204	12363	232	12518	80	12667	145, 179
11775	148, 285	11915	74			12165	207	12367	73	12519	80	12669	145, 178
11776	148, 285	11916	74	12059	91, 96, 128, 131	12171	844	12368	73	12520	156, 157	12671	410
11777	148, 285	11917	71			12172	844	12369	73	12521	156, 157	12675	156
11778	148, 285	11918	71	12060	92, 97, 128, 132	12173	844	12370	73	12522	156, 157	12676	316
11779	148, 285	11919	71			12177	844	12374	164	12523	156, 157	12682	831
11780	148, 285	11920	71	12061	91, 96, 128, 131	12184	843	12375	164	12524	156, 157	12683	831
11782	282	11921	71			12209	197, 399	12376	164	12525	156, 157	12684	831
11783	282	11922	71	12062	91, 95, 128, 131	12210	197, 399	12377	164	12528	293	12685	831
11784	72	11923	71			12213	72, 91, 95	12378	164	12529	293	12686	831
11785	72	11924	71	12064	121, 123	12214	72	12379	164	12534	235	12688	831
11786	72	11925	181	12065	121, 124	12215	72	12380	164	12535	235	12689	831
11787	72	11926	181	12066	121, 125	12216	72	12381	164	12536	235	12693	121, 124
11788	72	11927	181	12067	121, 124	12217	72	12382	164	12537	235	12695	156
11789	72	11928	181	12068	94, 103, 130, 136	12218	72	12383	164	12538	235	12697	152
11790	72	11929	181			12228	594	12384	164	12539	235	12698	152
11791	72	11931	181	12069	410	12232	121, 123	12385	164	12540	235	12699	152
11792	72	11933	181	12076	269	12233	269	12386	165	12541	235	12700	152
11795	411	11935	122, 126	12077	268	12234	269	12387	165	12542	235	12701	152
11796	472, 475	11936	620	12078	268	12235	270	12389	165	12543	235	12703	152
11797	457, 475	11948	217	12079	232	12236	269	12390	165	12544	235	12704	152
11805	163	11949	70, 131, 850, 851	12080	301	12237	236, 244, 253	12391	165	12545	235	12705	152
11806	163			12081	301			12392	165	12546	235	12707	152
11807	163	11950	70, 131, 850, 851	12084	301	12253	141	12394	163	12547	235	12708	152
11808	163			12085	301	12254	140	12395	163	12548	235	12709	152
11809	163	11953	274	12086	301	12255	141	12396	163	12549	235	12710	152
11810	163	11954	274	12088	301	12259	141	12397	163	12550	235	12711	152
11811	163	11955	274	12089	301	12260	141	12399	163	12551	235	12713	552, 618, 765
11812	163	11956	274	12092	301	12265	176	12400	163	12552	235		
11813	163	11957	274	12093	301	12268	826	12404	163	12553	235	12715	156
11814	163	11958	274	12094	301	12269	826	12405	165	12554	235	12723	152
11815	163	11961	274	12095	91, 96	12270	826	12406	165	12555	235	12729	582
11817	295	11963	274	12097	92, 98, 128, 132	12271	826	12407	165	12556	235	12731	429, 475
11826	547	11973	115, 138			12272	826	12419	226	12563	555	12735	550, 616, 811
11827	207	11974	115, 138	12103	70, 131, 850, 851	12273	826	12420	226	12565	455, 475	12737	472, 475
11828	207	11980	115, 138			12274	826	12421	226	12566	553, 618	12738	92, 98, 128, 132
11829	207	11981	115, 138	12104	70, 131, 850, 851	12276	826	12422	226	12567	571, 505, 625, 534		
11830	207	11982	115, 138			12277	826	12423	226			12739	91, 95, 128, 131
11831	582	11983	115, 138	12105	70, 131, 850, 851	12278	826	12424	226	12569	595, 617		
11838	549	11984	115, 138			12279	826	12425	226	12571	429, 475	12740	91, 96, 128, 131
11841	596	11987	115, 138	12115	141	12280	826	12426	226	12575	145, 178		
11842	433, 475	11989	115, 138	12116	141	12281	826	12427	226	12576	658	12741	91, 97, 128, 132
11852	303	11990	115, 138	12117	141	12283	827	12428	226	12583	741		
11853	295	11991	115, 138	12118	141	12284	827	12429	226	12585	741	12742	92, 98, 128, 132
11854	570, 492, 534	11993	115, 138	12119	141	12285	827	12430	226	12591	716		
		11995	115, 138	12122	141	12286	827	12431	226	12592	232	12756	572, 529, 534
11855	550, 764	11998	115, 138	12123	141	12288	827	12432	226	12594	555		
11863	409	12009	88, 90	12124	141	12290	827	12433	226	12595	139, 821	12757	572, 528, 534
11864	145, 178	12021	826	12125	141	12292	827	12434	226	12596	139		
11865	552, 595	12022	826	12126	141	12293	827	12435	226	12598	253	12759	431, 475
11871	548	12023	826	12127	141	12295	827	12436	226	12599	253	12766	430, 475
11872	192	12024	826	12129	114	12303	828	12437	226	12600	238, 253	12771	181
11873	192	12025	826	12134	410	12305	828	12439	226	12602	555	12772	181
11874	192	12026	826	12135	402	12314	593	12440	226	12605	548	12773	181
11876	149	12027	826	12137	430, 475	12315	593	12441	226	12606	612		



## NUMERICAL INDEX

Auveco No.	Page No.	Auveco No.	Page No.	Auveco No.	Page No.	Auveco No.	Page No.	Auveco No.	Page No.	Auveco No.	Page No.	Auveco No.	Page No.
12774	181	12932	199	13031	821	13232	88,	13328	83	13445	234	13614	122, 127
12775	181	12933	199	13039	316		89, 167	13329	83	13446	234	13616	620
12776	181	12934	197	13040	316	13233	253	13330	83	13447	234	13617	121, 124
12777	181	12935	197	13041	316	13234	85	13331	83	13449	234	13618	122, 126
12778	181	12936	197	13042	316	13235	85	13332	83	13450	549	13619	122, 127
12779	181	12937	197	13043	316	13236	85	13333	83	13453	471, 475	13620	128
12781	181	12938	197	13044	316	13237	85	13334	83	13454	421, 475	13625	848
12782	181	12939	199	13045	316	13239	85	13335	83	13456	580	13626	848
12783	181	12940	199	13046	316	13240	85	13336	83	13457	568,	13629	269
12784	181	12943	199	13047	316	13241	85	13337	83		505, 534	13630	268
12785	181	12944	199	13048	316	13242	85	13338	83	13458	556	13631	268
12786	181	12946	197	13049	316	13243	85	13339	83	13461	471, 475	13632	268
12787	181	12947	199	13050	316	13244	85	13340	83	13464	765	13634	257
12788	181	12948	199	13051	316	13245	85	13341	83	13466	112, 616	13636	257
12789	181	12949	199	13052	316	13246	85	13342	83	13467	435, 475	13639	257
12790	181	12950	72	13053	316	13248	85	13343	83	13469	513,	13643	257
12791	207, 213	12951	72	13054	316	13249	85	13344	83		534, 606	13644	252
12792	207, 213	12952	72	13055	316	13251	85	13345	83	13470	455, 476	13647	617
12794	620	12953	72	13056	316	13252	85	13346	84	13472	613, 634	13656	209
12795	69	12954	72	13057	316	13253	85	13347	84	13475	471, 476,	13657	209
12796	69	12955	72	13058	316	13256	84	13348	84		768, 815	13658	209
12797	69	12956	72	13059	316	13258	84	13349	84	13476	160	13659	209
12798	69	12957	72	13060	316	13260	85	13350	84	13477	160	13660	209
12799	71	12958	824	13061	316	13261	85	13352	84	13480	160	13661	209
12800	71	12959	824	13062	316	13262	85	13353	84	13481	160	13662	209
12801	70	12960	824	13063	316	13263	85	13354	84	13494	160	13663	209
12802	70	12961	824	13064	316	13264	85	13355	84	13495	160	13664	209
12803	70	12962	824	13065	316	13265	83	13356	84	13514	269	13665	209
12806	70	12966	567, 824	13095	316	13266	83	13357	84	13520	270	13666	209
12807	70	12971	567, 824	13120	316	13267	83	13359	84	13521	270	13669	209
12809	70	12975	228	13121	316	13268	83	13360	84	13522	270	13670	209
12811	70	12977	232	13124	316	13269	83	13361	84	13523	269	13671	209
12818	72	12978	160	13128	316	13270	83	13362	84	13524	269	13672	209
12820	72	12979	160	13132	316	13271	83	13363	84	13528	269	13673	209
12824	555	12980	160	13133	316	13272	83	13364	84	13529	269	13674	209
12832	842	12981	160	13134	316	13273	83	13365	84	13530	269	13675	209
12833	842	12982	160	13136	316	13274	83	13366	84	13531	269	13676	209
12851	842	12983	160	13141	727	13275	83	13367	84	13533	244	13677	209
12852	842	12984	160	13144	728	13276	83	13368	84	13535	244	13678	209
12858	842	12985	160	13157	728	13277	83	13370	84	13537	244	13679	209
12859	842	12986	160	13158	650	13278	83	13373	84	13540	236	13680	209
12860	842	12987	160	13162	143, 657	13279	83	13374	84	13541	253	13681	209
12861	842	12988	163	13167	652	13280	83	13375	84	13542	253	13682	209
12870	842	12989	163	13170	651	13281	83	13377	84	13543	238	13683	211
12890	842	12990	163	13173	810, 822	13282	83	13391	84	13544	237	13684	211
12893	69	12991	163	13174	808	13283	83	13392	85	13545	238	13685	211
12894	69	12992	472, 475	13179	470, 475,	13284	83	13393	85	13546	238	13686	233
12895	69	12993	418,		653, 816	13286	83	13394	85	13547	243	13687	91, 97
12896	69		475, 766	13189	808	13288	83	13395	85	13548	243	13691	183
12897	69	12995	167	13191	822	13289	83	13396	85	13549	236	13692	183
12899	70	12996	167	13198	421,	13290	83	13397	85	13552	268	13693	183
12900	70	12997	167		475, 657	13291	83	13398	85	13554	256	13694	183
12902	71	12999	167	13206	812	13292	83	13401	85	13555	268	13695	183
12903	71	13002	168	13215	142,	13293	83	13402	85	13556	269	13696	183
12904	71	13003	168		656, 733	13294	83	13403	85	13558	236	13697	183
12905	71	13004	168	13216	142, 656,	13298	83	13404	85	13559	256	13698	183
12907	197, 399	13005	168		733, 757,	13299	83	13405	85	13564	403	13699	183
12908	197, 399	13006	168		770, 820	13300	83	13406	85	13572	849	13701	183
12909	431, 475	13007	168	13218	142,	13301	83	13409	84	13574	847	13704	122, 126
12916	198	13008	168		656, 733	13302	83	13410	84	13575	848	13705	122, 127
12917	198	13009	168	13220	144, 733,	13304	83	13411	84	13577	856	13707	91, 94
12918	198	13010	168		757, 823	13306	83	13412	84	13578	848	13708	91, 95
12919	198	13011	168	13221	142, 656	13308	83	13413	84	13579	849	13709	93, 100
12920	198	13012	167	13223	142,	13310	83	13414	84	13580	829	13711	91, 97
12921	198	13014	167		656, 732	13311	83	13415	84	13581	830	13712	91, 96
12922	198	13016	167	13224	142, 732	13312	83	13417	84	13582	830		128, 131
12923	198	13017	167	13225	142, 681,	13314	83	13420	84	13584	830	13715	121, 124
12924	198	13019	93, 102,		739, 757, 808	13316	83	13421	84	13587	830	13717	180, 412
12925	198		130, 135	13227	141, 812	13322	83	13422	84	13590	829	13718	180, 412
12926	198	13021	93, 102	13230	490, 534,	13323	83	13424	84	13599	829	13719	180, 412
12927	199	13025	91, 95		730, 823	13324	83	13426	84	13600	829	13720	180, 412
12929	197	13026	92, 97	13231	88,	13325	83	13429	84	13601	829	13721	180, 412
12930	197	13027	92, 99		89, 167	13326	83	13430	84	13610	829	13723	180, 412
12931	197	13030	616			13327	83	13434	84	13613	122, 126	13724	180, 412

# NUMERICAL INDEX

Auveco No.	Page No.	Auveco No.	Page No.	Auveco No.	Page No.	Auveco No.	Page No.	Auveco No.	Page No.	Auveco No.	Page No.	Auveco No.	Page No.
13725	180, 412	13896	183	14019	529, 535,	14205	845	14337	755	14435	117	14583	117
13727	73	13897	183		609, 628	14206	845	14345	755	14436	117	14584	117
13728	73	13898	183	14020	577, 529,	14207	845	14347	447, 476,	14437	118	14585	117
13746	297	13899	183		609, 535	14208	845		748, 792	14438	118	14586	117
13747	297	13900	183	14021	416, 476	14209	822	14348	444,	14439	118	14587	117
13748	297	13902	183	14023	297	14210	822		476, 748	14440	118	14588	117
13749	297	13903	183	14030	550, 811	14211	822	14349	442, 476,	14441	118	14589	117
13750	298	13904	183	14031	550	14212	822		719, 747	14442	118	14590	118
13751	298	13905	183	14032	424, 476	14217	582,	14352	443,	14443	118	14591	118
13752	298	13906	183	14033	556		610, 634		476, 747	14444	118	14592	118
13753	298	13907	183	14035	424, 476	14218	618	14353	447,	14445	118	14595	118
13754	297	13908	183	14036	424, 476	14220	552		476, 748	14446	118	14598	118
13755	297	13909	183	14037	552, 618	14225	156	14355	442,	14447	118	14602	118
13756	296	13910	183	14053	70,	14227	156		476, 747	14448	138	14604	119
13757	435, 476	13911	183		129, 130	14228	156	14356	448,	14449	138	14605	119
13766	300	13912	183	14055	232	14231	156		476, 748	14450	138	14606	119
13767	300	13913	183	14059	190	14235	156	14357	717	14451	138	14607	119
13768	300	13914	183	14060	190	14237	156	14359	724	14452	138	14608	119
13769	300	13916	183	14063	190	14241	156	14363	470,	14453	138	14610	119
13770	300	13918	183	14064	190	14244	156		476, 721	14454	138	14611	119
13773	301	13919	183	14065	190	14253	156	14364	717	14455	138	14612	119
13774	301	13920	183	14066	190	14255	665,	14365	724	14456	138	14613	119
13796	300	13921	183	14067	190		717, 735	14366	717, 743	14457	138	14616	119
13805	299	13922	105, 110	14068	190	14256	785	14367	415,	14458	138	14617	119
13807	299	13925	554	14070	190	14258	785		476, 719	14459	138	14625	138
13808	296	13927	620	14072	190	14260	568, 498,	14369	515,	14461	846	14626	138
13810	229	13930	717, 742	14074	190		535, 722, 801		535, 723	14462	215	14629	138
13811	229	13931	742	14089	191	14263	786	14376	272, 725	14473	105, 108	14632	146
13814	229	13932	736, 785	14094	191	14264	781	14378	724	14474	208, 234	14633	146
13816	229	13933	550	14095	191	14265	786	14380	448,	14486	303	14634	146
13828	556	13934	105, 111	14096	191	14266	788		476, 720	14487	80	14636	146
13831	70, 412	13937	270	14097	191	14267	706, 789	14388	270	14489	80	14637	146
13832	70, 412	13939	270	14098	191	14268	667, 787	14389	230	14490	80	14642	555
13833	70, 412	13944	270	14099	191	14269	464, 476,	14391	116	14491	80	14677	278
13834	70, 412	13945	471,	14100	191		694, 721, 799	14392	116	14493	80	14678	280
13835	70, 412		476, 751	14101	191	14270	465,	14393	116	14494	80	14685	663
13836	70, 412	13946	472, 476	14102	191		476, 799	14394	116	14495	80	14687	680
13837	70, 412	13960	550	14103	191	14271	785	14395	116	14496	80	14688	680
13838	70, 412	13964	169	14104	191	14273	706, 789	14396	116	14497	80	14690	666, 745
13839	70, 412	13965	169	14113	190	14274	666, 717,	14398	116	14498	80	14695	667, 717,
13840	70, 412	13966	170, 765	14127	311		742, 785	14400	117	14499	80		736, 743, 787
13841	70, 412	13967	395	14128	244	14275	736,	14401	117	14500	80	14696	498, 535,
13842	70, 412	13992	472, 476	14130	245		744, 787	14402	117	14501	80		678, 694, 752
13843	620	13993	573, 506,	14131	244	14276	144, 808	14403	117	14521	139	14697	568, 496,
13847	620		607, 626, 534	14132	244	14277	786	14404	117	14522	139		535, 678, 722
13850	227	13994	577, 529,	14133	244	14281	667, 787	14405	117	14523	139	14698	508,
13851	227		609, 534	14135	244	14282	443,	14406	117	14524	472, 476		535, 678
13856	580	13996	574,	14144	465,	14284	476, 668	14407	117	14526	175	14700	664
13858	582		506, 534		476, 799	14288	680, 806	14408	117	14527	175	14701	663
13860	580	13999	572,	14145	550		665	14409	117	14529	271	14703	664
13863	195		490, 534	14147	577,	14287	665	14410	117	14530	271	14705	664
13864	195	14001	568,		529, 535	14288	665	14411	117	14531	271	14709	420,
13865	195		504, 534	14150	215	14289	418,	14412	117	14532	271		476, 720
13866	195	14002	549	14151	215		476, 669	14413	117	14533	271	14719	716
13867	195	14004	297	14152	215	14291	442,	14414	117	14541	845	14720	448,
13869	195	14005	297	14153	216		476, 668	14415	117	14543	848		476, 737
13871	195	14006	417, 476	14154	216	14294	665	14417	117	14544	581, 271	14723	447,
13872	195	14007	571, 505,	14163	434, 476	14298	272,	14418	117	14545	581, 271		476, 748
13873	195		625, 534	14170	844		680, 725	14419	117	14546	581, 271	14724	743
13875	195	14008	567,	14171	844	14299	436,	14420	117	14547	581, 271	14725	532,
13876	195		533, 534	14172	844		476, 673	14421	117	14548	592		535, 755
13877	195	14009	552	14173	844	14306	659	14422	117	14549	592	14726	505,
13879	195	14010	571, 528,	14174	844	14308	659	14423	117	14550	592, 615		535, 752
13880	195		625, 534	14178	844	14313	666,	14424	117	14551	615	14727	567, 532,
13881	195	14011	571,	14194	821		717, 742	14425	117	14552	632		535, 694, 755
13883	195		504, 534	14196	276	14317	665	14426	117	14553	593	14728	464,
13885	195	14012	297	14197	225	14319	448,	14427	117	14559	591		476, 797
13887	195		550, 811	14198	225		476, 671	14428	117	14561	633	14732	805
13888	183	14014	572, 490,	14199	225	14323	447,	14429	117	14568	274	14736	444,
13891	183		625, 534	14200	225		476, 671	14430	117	14575	848		476, 792
13892	183	14016	418, 476	14201	225	14328	436,	14431	117	14576	848	14737	443, 476,
13893	183		512,	14202	225		476, 673	14432	117	14580	241		748, 791
13894	183	14018	534, 608	14203	225	14334	742	14433	117	14581	117	14738	446,
13895	183			14204	225	14335	736, 743	14434	117	14582	117		476, 794



## NUMERICAL INDEX

Auveco No.	Page No.	Auveco No.	Page No.	Auveco No.	Page No.	Auveco No.	Page No.	Auveco No.	Page No.	Auveco No.	Page No.	Auveco No.	Page No.
14739	694, 785	14866	146	14991	570, 506,	15100	283	15200	274	15403	78	15586	153
14745	784	14867	146		605, 535	15101	283	15202	274	15404	78	15587	153
14746	784	14868	146	14992	500, 535,	15102	283	15203	274	15413	105, 110	15588	153
14747	784	14869	146		604, 624	15103	283	15204	224	15414	425, 477	15589	153
14749	784	14870	146	14993	506,	15104	283	15205	224	15415	283	15590	153
14750	143,	14871	146		535, 570	15106	283	15206	224	15416	283	15591	153
	725, 807	14873	154	14994	529,	15107	283	15207	224	15417	283	15592	153
14751	784	14874	154		535, 606	15108	283	15208	224	15418	283	15594	153
14753	570, 506,	14875	154	14995	569, 495,	15109	283	15209	224	15420	283	15595	153
	605, 624, 535	14876	154		604, 623, 535	15110	283	15212	846	15422	284	15596	153
14754	595	14877	154	14997	569,	15111	283	15239	226	15423	284	15597	153
14755	595	14878	154		500, 535	15114	284	15240	226	15424	284	15598	153
14756	595, 617	14879	181	14998	570,	15115	284	15256	226	15426	148, 285	15599	153
14757	422, 476	14880	218		524, 535	15116	284	15257	226	15431	148, 285	15601	153
14758	473, 476	14881	218	15000	283	15117	284	15258	226	15434	148, 285	15603	228
14765	390	14883	217	15004	157	15118	284	15259	226	15439	283	15605	228
14769	853	14884	222	15009	157	15119	284	15260	226	15440	283	15606	228
14770	853	14885	222	15010	157	15120	284	15263	226	15444	284	15607	228
14774	337	14887	220	15011	157	15121	284	15301	546, 848	15446	284	15608	228
14775	337	14888	220	15015	157	15122	148, 285	15316	139	15450	283	15609	228
14777	118	14889	220	15017	158	15123	148, 285	15318	139	15453	396	15610	228
14778	118	14892	221	15018	158	15124	148, 285	15325	139	15456	433, 477	15611	228
14779	118	14895	613	15035	222	15125	148, 285	15326	139	15457	433, 477	15618	228
14780	118	14896	213	15037	91, 95	15126	148, 285	15327	139	15459	586	15619	228
14781	118	14897	213	15039	230	15127	148, 285	15328	139	15461	471, 477	15620	228
14782	118	14898	207, 213	15040	423, 476	15128	148, 285	15329	139	15462	403	15621	228
14784	118	14901	193	15042	578,	15129	148, 285	15330	139	15463	403	15622	228
14787	118	14903	193		530, 535	15130	148, 285	15331	139	15466	403	15625	228
14788	118	14904	193	15043	577,	15131	148, 285	15332	139	15467	404	15628	228
14789	118	14905	193		526, 535	15132	148, 285	15333	139	15468	741	15632	228
14790	118	14906	193	15044	578,	15133	148, 285	15334	139	15470	742	15640	153
14791	118	14907	193		530, 536	15134	148, 285	15335	139	15472	664	15641	153
14792	118	14908	193	15045	578,	15135	148, 285	15337	139	15478	430, 477	15642	153
14793	118	14909	193		530, 536	15136	148, 285	15345	155	15479	431, 477	15643	153
14794	118	14910	193	15046	230	15137	148, 285	15347	155	15480	429, 477	15644	153
14796	138	14911	193	15048	230	15138	148, 285	15350	155	15481	428, 477	15645	153
14797	138	14912	193	15049	230	15139	148, 285	15351	155	15488	297	15646	153
14799	295	14913	70, 131,	15050	420, 477	15140	148, 285	15355	73	15490	298	15649	153
			850, 851	15054	283	15141	148, 285	15356	73	15491	298	15650	153
14801	202, 844	14916	70, 131,	15055	283	15142	148, 285	15357	73	15497	217	15651	153
14802	202, 844		850, 851	15056	283	15143	148, 285	15358	73	15498	217	15652	153
14803	202, 844	14918	238,	15057	284	15144	274	15366	603, 724	15499	217	15653	153
14804	202, 844		245, 255	15058	284	15145	274	15367	420, 477	15504	221	15654	153
14805	202, 844	14920	213	15059	284	15146	274	15372	226	15505	235	15664	425, 477
14807	202, 844	14921	416, 476	15060	284	15147	274	15373	92, 98,	15506	235	15666	634, 808
14808	202, 844	14923	195	15061	284	15148	274		128, 132	15507	235	15668	434, 477
14813	200	14926	845	15062	284	15150	274	15374	78	15508	235	15669	471, 477
14814	172	14927	845	15065	283	15151	274	15375	78	15509	235	15670	472, 477
14820	584, 612	14946	554	15066	284	15158	212	15376	78	15512	117	15672	505,
14822	172	14947	121,	15067	148, 285	15159	212	15377	78	15514	117		536, 624
14824	114		125, 167	15068	283	15160	212	15378	78	15515	118	15673	587, 630
14827	114	14953	567, 532,	15069	283	15161	212	15379	78	15516	118	15674	587, 630
14830	414		603, 535	15072	283	15162	212	15380	78	15517	118	15675	614
14833	414	14967	587, 614,	15073	283	15163	212	15381	78	15518	588	15676	549
14834	414		630, 634	15074	283	15164	212	15382	78	15522	503,	15677	176
14835	414	14968	582	15075	283	15165	212	15383	78		536, 607	15684	303
14836	274	14970	72	15076	283	15166	212	15385	78	15523	428, 477	15687	414
14837	274	14972	72	15077	283	15167	212	15386	78	15525	834	15688	286
14838	274	14973	72	15078	284	15168	212	15387	78	15526	834	15689	286
14839	274	14974	229	15079	284	15170	106, 109	15388	78	15527	277	15691	286, 855
14840	274	14975	229	15080	284	15171	91, 96	15389	78	15528	281	15692	286, 855
14847	181	14976	88,	15082	284	15172	91, 95	15390	78	15529	281	15694	286
14848	181		89, 167	15083	284	15180	80	15391	78	15530	281	15695	558, 779
14850	181	14977	88,	15084	284	15187	297, 309	15392	78	15531	337	15701	528,
14851	181		89, 167	15085	284	15188	274	15393	78	15532	337		536, 609
14852	181	14980	141	15086	284	15189	274	15394	78	15533	337	15702	577,
14854	181	14985	436,	15087	284	15190	274	15395	78	15538	203		529, 536
14855	140		476, 629	15088	284	15191	274	15396	78	15539	203	15705	224
14856	140	14987	569, 493,	15089	284	15192	274	15397	78	15540	203	15706	224
14857	418, 476		623, 535	15094	283	15194	274	15398	78	15541	203	15707	465,
14858	630	14988	493,	15096	284	15196	274	15399	78	15542	203		477, 799
14859	72		535, 604	15097	284	15197	274	15400	78	15543	426, 477	15709	464,
14860	72	14990	569,	15098	148, 285	15198	274	15401	78	15544	163		477, 799
14861	72		492, 535	15099	148, 285	15199	274	15402	78	15545	86	15711	141
14862	72												

# NUMERICAL INDEX

Auveco No.	Page No.	Auveco No.	Page No.	Auveco No.	Page No.	Auveco No.	Page No.	Auveco No.	Page No.	Auveco No.	Page No.	Auveco No.	Page No.
15721	91, 96, 128, 131	15898	79	16032	294	16204	843	16369	77	16617	138	16720	91, 97, 128, 132
15748	853	15903	79	16033	74	16205	843	16370	77	16622	575, 512, 536	16721	180
15752	174	15905	79	16034	74	16207	843	16371	77			16725	532, 536, 755
15753	274	15910	79	16035	74	16213	546	16372	77	16624	573, 505, 536	16726	510, 536, 608
15754	274	15911	181	16036	74	16236	168	16375	77	16625	576, 522, 536	16727	192
15758	106, 107	15912	181	16037	74	16237	168	16376	77	16626	387	16736	69, 74
15759	588	15913	181	16038	74	16240	168	16377	77	16629	387	16743	187
15764	387	15914	181	16039	74	16242	168	16378	77	16631	387	16744	187
15765	387	15915	181	16040	74	16244	168	16380	77	16632	387	16745	187
15766	387	15916	181	16041	74	16248	168	16381	77	16633	387	16746	187
15767	387	15917	181	16042	74	16251	168	16382	77	16634	387	16747	187
15768	387	15918	181, 275	16043	74	16252	168	16383	77	16635	387	16748	187
15769	387	15919	181, 275	16044	74	16253	168	16384	77	16636	387	16751	120
15770	387	15921	216	16045	201	16255	168	16385	77	16638	387	16754	120, 122
15771	387	15922	216	16046	201	16256	168	16386	77	16642	387	16755	120, 122
15772	387	15924	217	16049	201	16259	425, 477	16387	77	16643	387	16761	120, 122
15773	387	15926	233	16051	201	16260	471, 477	16389	77	16644	387	16762	120, 122
15774	91, 96	15927	233	16052	201	16261	472, 477	16390	392	16645	387	16763	146
15775	92, 98, 129, 133	15928	233	16066	201	16262	430, 477	16391	393	16646	387	16764	146
15776	93, 102, 130, 135	15929	233	16067	201	16263	430, 477	16392	392	16647	387	16766	834
15778	121, 124	15930	233	16070	201	16264	197, 399	16393	393	16648	387	16767	834
15779	121, 125	15931	233	16071	201	16265	572, 528, 536	16394	393	16649	387	16769	140
15780	122, 127	15932	233	16072	201	16267	174	16395	392	16650	387	16770	155
15783	88, 90	15933	233	16087	843	16268	139, 821	16399	594	16654	201	16771	155
15788	121, 124	15935	217	16088	843	16269	140	16407	78	16665	231	16774	139
15790	122, 126	15937	215	16089	843	16275	286, 855	16411	78	16666	231	16775	426, 477, 670, 749
15791	121, 123	15938	219	16090	843	16276	286, 855	16412	78	16667	856	16776	422, 477, 670, 749
15792	88, 90	15939	219	16091	843	16277	286, 855	16413	78	16669	111	16777	447, 477, 720, 792
15793	841	15940	594	16092	843	16279	286, 855	16416	78	16673	182	16778	470, 477, 721, 795
15794	841	15941	91, 95, 128, 131	16093	843	16280	286, 855	16418	414	16675	182	16779	448, 477, 671, 793
15795	841	15944	219	16094	843	16286	856	16419	414	16676	182	16780	755, 805
15796	841	15945	220	16095	843	16288	856	16420	106, 107	16677	182	16781	444, 477, 669, 792
15797	841	15946	218	16096	843	16293	856	16422	106, 107	16680	275	16782	520, 536, 677, 753
15798	841	15947	218	16097	843	16296	845	16454	389	16681	275	16783	493, 536, 751
15799	842	15948	215	16108	843	16299	845	16455	389	16682	275	16784	508, 536, 752, 802
15800	841	15949	214	16115	532, 536, 655	16299	845	16456	389	16683	275	16785	160
15801	841	15950	214	16124	141, 728	16303	845	16457	389	16684	275	16788	161
15803	842	15951	214	16132	426, 477, 823	16306	806	16458	389	16685	275	16789	161
15805	842	15952	214	16134	141, 823	16308	279	16470	140, 681	16686	275	16791	295
15807	120, 121	15953	214	16136	139	16322	145, 178	16478	91, 96	16687	308	16793	295
15813	401, 634	15954	214	16137	139	16323	106, 108	16484	205	16688	307	16793	120
15818	122, 125	15955	216	16142	142	16324	388	16485	205	16689	308	16794	120
15827	92, 99	15956	216	16149	75	16325	388	16486	206	16690	111	16795	120
15851	271	15957	216	16152	75	16326	388	16487	204	16691	778	16800	111, 783
15854	270	15960	217	16159	165	16327	388	16488	204	16692	778	16801	221
15858	227	15962	93, 102, 130, 135	16161	165	16328	388	16489	204	16693	240	16804	221
15860	834	15966	594	16162	165	16330	388	16506	840	16694	239	16806	218
15861	834	15968	594	16163	163	16331	388	16514	240	16695	458, 477	16816	572, 497, 536
15862	834	15970	472, 477	16164	163	16332	388	16525	393	16697	117	16818	423, 477
15863	152	15973	295	16166	854	16333	388	16527	230	16698	117	16821	784
15864	152	15977	659	16169	854	16335	388	16534	92, 97	16699	117	16825	665
15865	152	15997	659	16174	238, 245, 254, 255	16336	388	16564	843	16700	117	16826	105, 108, 121, 124
15867	116	15998	432, 477, 670	16175	239, 245, 254, 255	16340	401, 756	16565	843	16701	117	16828	93, 103, 130, 136
15868	116	16000	516, 536, 679, 723, 753	16177	161	16341	163	16567	843	16702	117	16829	141
15869	116	16001	274	16178	161	16342	220	16568	841	16703	117	16830	140
15870	116	16004	223	16179	161	16344	220	16571	841	16704	117	16832	396
15871	116	16009	180, 411	16180	161	16348	220	16575	841	16705	117	16833	783
15873	116	16011	180, 411	16182	161	16349	221	16578	230	16706	117	16834	307
15874	116	16012	180, 411	16183	161	16351	235	16585	238	16707	117		
15875	116	16013	180, 411	16184	161	16352	235	16586	238	16708	117		
15876	116	16015	180, 411	16187	161	16353	235	16589	93, 100, 129, 134	16709	117		
15877	116	16016	180, 411	16188	161	16354	235	16593	180, 411	16710	117		
15878	116	16017	471, 477	16189	161	16355	235	16596	91, 95, 128, 131	16711	117		
15879	116	16018	182	16190	161	16356	235	16603	832	16712	117		
15880	116	16019	182	16192	161	16357	235	16604	832	16713	117		
15881	116	16020	182	16193	161	16358	235	16609	118	16714	118		
15888	116	16021	182	16194	161	16359	235	16610	118	16715	118		
15890	116	16022	182	16195	161	16360	235	16611	118	16716	118		
15893	116	16023	182	16198	843	16362	77	16612	118	16717	118		
15895	116	16026	275	16200	843	16363	77	16613	118	16718	118		
15896	116	16031	294	16202	843	16364	77	16614	118				





# NUMERICAL INDEX

Auveco No.	Page No.	Auveco No.	Page No.	Auveco No.	Page No.	Auveco No.	Page No.	Auveco No.	Page No.	Auveco No.	Page No.	Auveco No.	Page No.
17664	425, 478	18108	297	18244	311	18383	595	18503	529,	18698	231	18842	446,
17666	566, 413	18109	286	18245	855	18386	610		538, 609	18699	231		479, 793
17667	598	18110	286	18246	855	18387	612	18504	611	18700	231	18843	786
17669	467, 478	18111	286	18248	442, 478	18389	416, 478	18508	441, 478	18701	231	18844	463,
17683	250	18113	404, 742	18249	630	18390	558	18509	437, 478	18702	231		479, 797
17684	247	18114	446, 478,	18251	139	18391	456, 478	18510	436, 478	18703	231	18846	786
17685	469, 478		645, 670	18253	140	18392	587	18512	679	18705	231	18848	455, 479
17686	208, 234	18115	668	18261	91, 97,	18393	587	18515	121, 123	18706	231	18849	275
17690	242	18118	555		28, 132	18394	530,	18518	230	18707	231	18853	220
17691	243	18119	523,	18262	584		538, 628	18519	230	18708	231	18855	222
17974	405		537, 679	18263	594	18395	582, 409	18520	230	18716	211	18856	222
17975	434, 478	18121	282	18265	503,	18396	304	18521	230	18726	275	18857	222
17976	592	18122	282		537, 752	18398	566, 413	18522	230	18727	294	18858	222
17977	312	18127	832	18268	578,	18401	145, 179	18524	239	18728	294	18859	423, 479
17978	848	18128	832		530, 537	18402	582, 409	18525	242	18729	294	18861	450,
17979	556	18129	832	18269	526,	18404	664	18527	241	18730	294		479, 795
17980	106, 108	18132	832		537, 628	18405	662	18530	243	18731	294	18862	468, 479
17981	661	18134	388	18270	504,	18415	668	18531	140, 153	18732	294	18864	663
17983	82	18135	388		537, 712	18416	122, 126	18533	389	18733	231	18865	662
17988	514,	18136	388	18271	444,	18417	556	18534	389	18734	231	18866	663
	537, 712	18137	388		478, 719	18418	557	18536	389	18735	231	18867	239
17989	703	18138	388	18277	432, 478	18423	557	18537	389	18736	231	18868	239
17990	444,	18139	388	18294	467,	18428	557	18539	389	18737	231	18870	239
	478, 709	18140	388		478, 673	18436	831	18540	389	18738	231	18871	243
17991	441,	18141	388	18296	92, 98	18437	831	18543	389	18743	298	18873	513,
	478, 710	18142	388	18297	443, 478,	18438	831	18547	166	18744	298		538, 803
17992	518,	18143	388		708, 791	18439	831	18548	166	18746	435, 478,	18874	466,
	537, 712	18144	388	18298	417, 478	18440	831	18554	166		646, 670		479, 799
17993	143, 714	18145	214	18299	275	18441	831	18557	166	18747	778	18875	452,
17994	258	18146	214	18301	423, 478	18442	831	18563	166	18748	584		479, 796
17995	258	18147	214	18302	416, 478	18443	831	18568	166	18749	311	18876	465,
17996	258	18148	214	18303	305	18444	831	18569	166	18750	195		479, 798
17997	258	18149	214	18304	306	18445	831	18576	166	18754	643	18877	440, 479,
17998	258	18150	214	18308	575,	18446	831	18586	166	18756	643		645, 674
17999	258	18151	214		514, 537	18447	831	18595	166	18760	643	18878	446,
18000	258	18152	215	18310	577,	18448	831	18597	166	18764	643		479, 793
18001	258	18153	584		529, 538	18449	145, 178	18607	166	18767	644	18882	603, 715
18002	258	18155	595	18312	224	18454	680	18613	166	18769	105, 108	18885	385
18003	258	18156	106, 107	18318	239	18456	644	18619	166	18770	416, 478	18887	231
18004	258	18157	444,	18320	239	18457	658	18624	166	18771	430, 479	18888	515,
18005	258		478, 668	18324	215	18458	446,	18626	166	18779	105, 107		538, 803
18006	258	18163	156	18325	215		478, 719	18630	166	18781	91, 96,	18889	313
18007	258	18165	504,	18326	216	18460	72,	18646	388		128, 131	18890	615
18008	258		537, 675	18327	506,		92, 99	18647	388	18798	195	18891	615
18010	258	18166	441,		538, 625	18461	308	18650	217	18799	195	18892	615
18011	258		478, 751	18329	310	18463	246	18651	218	18800	195	18893	505,
18012	258	18167	304	18330	441, 478	18464	246	18653	217	18801	195		538, 604
18013	258	18168	312	18331	315	18465	258	18654	217	18802	195	18894	506,
18014	258	18169	309	18334	578,	18466	258	18658	218	18803	195		538, 605
18015	258	18170	315		530, 538	18467	258	18659	218	18804	195	18895	506,
18016	258	18174	423, 478	18335	849	18468	258	18661	260	18806	195		538, 605
18017	258	18175	456, 478	18336	92, 99,	18469	258	18662	260	18807	120	18896	524,
18018	258	18177	120, 121		129, 133	18470	258	18665	275	18808	120		538, 576
18019	275	18187	120, 122	18337	145, 177	18472	259	18668	252	18809	120	18897	417, 479
18020	275	18194	225	18338	145, 177	18473	259	18671	250	18810	314	18898	176
18021	275	18202	197, 399	18339	145, 179	18474	259	18673	246	18811	293	18899	594
18022	277	18203	197, 399	18340	92, 99,	18475	259	18674	241	18812	293	18900	196
18023	277	18204	197, 399		129, 130	18476	259	18676	247	18814	293	18901	196
18024	279	18205	197, 399	18341	159	18477	259	18679	430, 478	18815	419, 479	18902	196
18025	279	18206	508, 537,	18342	110	18478	259	18680	430, 478	18816	598	18903	196
18026	281		608, 723	18343	111	18479	259	18682	419, 478	18817	91, 97,	18904	196
18027	281	18208	172	18344	110	18482	833	18683	415, 478		128, 132	18905	196
18028	297	18214	247	18346	110	18483	832	18684	415, 478	18818	441,	18906	196
18029	533,	18215	250	18347	111	18484	106, 110	18685	427, 478		479, 674	18907	196
	537, 623	18216	250	18348	110, 111	18485	110	18688	431, 478	18819	248	18908	196
18030	573, 506,	18217	248	18353	579,	18486	110	18690	218	18820	421, 479	18909	196
	626, 537	18218	252		497, 538	18487	110	18691	580	18824	458,	18910	196
18031	297	18236	644	18354	106, 109	18488	110	18692	439, 478,		479, 721	18911	554
18032	493,	18237	629	18371	424, 478	18489	294		720, 794	18825	618	18912	310
	537, 623	18238	111	18373	276	18498	602	18693	231	18827	434, 479	18913	297
18033	440, 478	18239	105, 111	18374	278	18499	304	18694	231	18829	275	18914	615
18034	617	18240	111	18375	280	18500	305	18695	231	18830	275	18915	467, 479
18102	612, 631	18241	105, 111	18377	599	18501	297	18696	231	18835	197	18916	239
18103	232	18242	297	18379	423, 478	18502	297	18697	231	18836	199	18917	240



## NUMERICAL INDEX

Auveco No.	Page No.	Auveco No.	Page No.	Auveco No.	Page No.	Auveco No.	Page No.	Auveco No.	Page No.	Auveco No.	Page No.	Auveco No.	Page No.
18918	242	19051	294	19149	417, 479	19248	503,	19334	453,	19449	437, 480	19554	242
18920	253	19053	294	19152	631		539, 823		480, 737	19450	715	19555	243
18921	253	19055	294	19153	757	19250	425, 479	19337	497,	19453	510,	19556	242
18923	238	19056	294	19154	599	19251	129, 134		539, 609		539, 676	19558	831
18924	236	19057	294	19155	435, 479	19252	833	19338	433, 480	19454	668	19559	831
18925	240	19058	294	19156	250	19253	833	19339	631	19455	125	19560	831
18926	588	19060	294	19157	251	19254	833	19341	393	19456	304	19561	831
18927	310	19061	294	19162	175	19257	466, 479,	19343	735	19458	304	19562	831
18930	469, 479	19062	300	19163	175		711, 798	19345	603	19459	310	19564	831
18931	275	19065	302	19164	175	19258	209	19352	425, 480	19460	312	19566	831
18932	275	19066	296	19165	175	19259	209	19354	425, 480	19461	303	19568	831
18934	94, 103	19076	251	19166	175	19260	209	19355	572,	19464	452,	19569	831
18935	312	19095	839	19170	93, 102,	19261	209		496, 539		480, 646	19570	831
18936	473, 479	19096	839		130, 135	19262	209	19356	457, 480	19465	644	19571	831
18938	313	19097	839	19171	439,	19263	315	19357	557	19466	460,	19572	831
18939	512,	19098	839		479, 674	19270	457, 479	19358	556		480, 647	19575	831
	538, 712	19099	839	19176	283	19271	203	19359	662	19467	443,	19576	202
18947	405	19100	839	19177	283	19272	203	19361	554		480, 646	19577	202
18948	417,	19102	231	19178	283	19273	203	19365	282	19468	432,	19578	202
	479, 749	19103	231	19183	592	19274	516,	19368	438, 480		480, 691	19579	202
18950	463,	19104	231	19186	492, 538,		539, 754	19370	557	19470	422,	19581	247
	479, 797	19105	231		647, 675	19275	457, 479	19371	426, 480		480, 669	19582	248
18951	523,	19106	231	19187	787	19277	596	19373	426, 480	19472	580, 610	19587	282
	538, 739	19107	231	19191	631	19278	92, 98,	19374	426, 480	19476	643, 662	19588	277
18952	212	19108	466,	19194	551, 788		129, 132	19376	309	19477	643, 662	19589	277
18979	400		479, 799	19195	502,	19279	280	19378	825	19479	644	19590	275
18980	120	19109	460,		538, 818	19281	405	19379	563	19480	145, 179	19591	275
18981	235		479, 797	19197	429, 479	19282	182	19380	781	19481	438,	19592	275
18982	235	19110	303	19199	229	19283	182	19381	563		480, 721	19593	275
18983	235	19111	312	19202	306	19284	182	19385	445,	19482	705	19594	615
18986	235	19112	446,	19203	461,	19285	182		480, 737	19483	441, 480,	19595	114
18987	235		479, 793		479, 797	19286	182	19386	466, 480		646, 675	19597	114
18988	235	19113	445, 479,	19204	783	19287	182	19387	579	19484	784	19601	275
18989	235		709, 793	19205	140	19288	182	19390	557	19485	112,	19602	567
18990	235	19114	446, 479,	19206	259	19289	182	19393	404		617, 736	19603	275
19000	197, 399		646, 670	19207	259	19290	182	19394	404	19486	549	19604	275
19001	197, 399	19115	664	19208	259	19291	182	19397	403	19487	735	19605	275
19002	197, 399	19116	440,	19209	260	19293	744	19401	410	19490	507,	19607	502,
19003	197, 399		479, 674	19210	467,	19294	233	19404	410		539, 802		539, 607
19004	251	19117	666		479, 800	19295	233	19406	306	19492	703	19613	553
19006	92, 99,	19118	517,	19213	455, 479	19296	233	19407	524,	19498	404	19614	553
	129, 133		538, 676	19215	295	19297	571,		539, 679	19499	228	19615	576,
19007	276	19120	705	19216	139		502, 539	19408	523,	19501	431, 480		522, 539
19013	498,	19121	426,	19219	501, 538,	19298	207		539, 679	19505	787	19618	282
	538, 801		479, 791		712, 805	19299	207	19410	554	19506	420, 480,	19619	282
19014	442,	19123	444,	19220	585	19306	502,	19411	557		646, 669	19620	282
	479, 790		479, 794	19225	642		539, 722	19413	412, 603	19511	501,	19621	275
19016	466,	19124	447,	19228	715	19307	666	19414	302		539, 610	19623	248
	479, 800		479, 792	19231	510,	19308	140	19415	662	19514	309	19626	824
19017	406	19125	245		538, 648	19309	140	19416	510, 539,	19515	310	19627	824
19018	406	19126	246	19232	504,	19310	631		677, 723, 802	19516	315	19628	467, 480
19019	406	19127	427, 479		538, 648	19311	499,	19417	94, 104,	19519	583, 631	19630	275
19020	406	19128	516,	19233	519, 538,		539, 678		130, 137,	19522	572,	19638	531, 539,
19021	406		538, 803		648, 676	19312	419,	19418	579, 629		494, 539		607, 629
19022	406	19129	468,	19235	388		480, 790	19419	437, 480	19524	474, 480	19639	573, 505,
19023	407		479, 800	19237	93,	19314	735		307	19526	598		626, 539
19024	407	19130	276		100, 598	19315	516,	19420	304	19527	457, 480	19640	617
19025	298	19131	623	19238	598		539, 723	19421	612	19529	805	19643	421,
19026	298	19132	295	19239	575, 518,	19317	585, 113	19422	513,	19533	668		480, 790
19027	298	19133	295		538, 648,	19318	277		539, 627	19534	707, 789	19644	145, 179
19028	298	19134	295		676, 738	19320	449,	19424	592	19535	707, 789	19645	568,
19029	298	19136	808	19240	93, 100		480, 737	19425	437, 480	19536	611		496, 539
19030	298	19138	598, 718	19242	568,	19322	736	19428	469, 480	19537	170	19646	667
19031	298	19139	276		492, 538	19323	445,	19429	552	19538	275	19647	780
19033	298	19140	568, 522,	19243	568,		480, 737	19430	779	19539	275	19648	716
19034	298		624, 538,		501, 538	19324	736	19435	552	19541	428, 480	19650	667
19036	298		649, 739, 804	19244	528,	19325	438,	19436	613	19545	276	19653	92, 99,
19037	298	19141	280		538, 609	19326	596	19439	658	19546	505,		129, 133
19045	293	19142	499,	19245	514,		480, 738	19440	580, 271		539, 678	19655	434, 480
19046	293		538, 678		538, 627	19328	739	19441	602	19547	504,	19657	306
19047	293	19143	667	19246	510,	19330	735	19442	380		539, 675	19658	588
19048	293	19145	461, 479,		539, 752	19331	444,	19443	381	19548	141	19661	249
19049	294		647, 671	19247	551		480, 737	19444	381	19552	501,	19666	389
19050	294	19147	756					19445	380		539, 801	19667	421, 480

## NUMERICAL INDEX

Auveco No.	Page No.	Auveco No.	Page No.	Auveco No.	Page No.	Auveco No.	Page No.	Auveco No.	Page No.	Auveco No.	Page No.	Auveco No.	Page No.
19668	643	19747	507,	19851	581, 271	20139	635	20234	500, 540,	20322	184	20401	613
19669	143, 175,		539, 722	19853	582	20143	640		654, 730	20324	638	20402	303
	725, 807	19748	718	19854	572,	20146	638	20243	845	20325	639	20404	728
19673	417,	19749	439,		490, 539	20147	638	20244	579,	20326	559	20405	822
	480, 673		481, 794	19855	425, 481	20149	637		515, 540	20327	512,	20407	532,
19676	551	19752	599	19880	251	20150	639	20245	595		540, 753		540, 823
19678	437, 480	19753	718	19881	247	20153	614, 724	20246	246	20328	561	20408	558
19680	662	19756	788	19882	241	20155	635	20247	509, 540,	20331	658	20409	839
19682	446,	19757	559	19883	248	20157	638		675, 738	20334	422,	20410	839
	480, 670	19758	470, 481	19885	251	20158	638	20248	521,		481, 669	20411	461, 482,
19683	441,	19760	428, 481	19887	248	20163	579,		540, 655	20335	507,		647, 672
	480, 674	19764	196	19889	250		495, 540	20250	812		540, 802	20412	788
19684	440,	19765	196	19890	245	20164	434, 481	20252	470,	20338	458, 481	20415	585, 613
	480, 751	19766	196	19891	240	20165	416, 481		481, 816	20339	145, 177	20416	145, 178
19686	415,	19767	196	19892	571,	20169	499,	20253	471,	20341	473,	20417	561
	480, 790	19769	196		530, 539		540, 609		481, 653		481, 816	20421	613
19687	854	19770	196	19893	422, 481	20171	598	20254	652	20342	398	20422	586
19688	854	19771	196	19894	621	20172	247	20256	419,	20344	416, 482	20423	586
19689	854	19772	196	19898	465,	20173	632		481, 749	20345	431, 482	20424	403
19690	854	19773	280		481, 799	20175	824	20259	93, 100,	20346	615	20425	596
19691	854	19774	423, 481	19899	703	20176	121, 123		129, 134	20347	278	20426	279
19692	854	19775	469, 481	19900	704	20177	423, 481	20261	122, 125	20348	523,	20427	469, 482
19693	854	19776	705	19904	503,	20179	617	20262	430, 481		540, 753	20428	468, 482
19694	854	19777	106, 108		539, 823	20180	437, 481	20263	402, 556	20349	508, 540,	20429	780
19695	854	19778	92, 99	19905	515,	20181	438, 481	20264	597		713, 752, 802	20431	785
19696	854	19779	632		540, 753	20182	436, 481	20265	570,	20350	665	20432	679
19697	854	19781	591	19907	515,	20184	421,		529, 540	20351	665	20434	120, 121
19698	854	19782	591		540, 803	20186	481, 790	20266	743	20352	504,	20435	120, 121
19701	854	19783	598,	19908	515,		651	20267	617		540, 678	20437	463,
19702	854		706, 786		540, 803	20187	491, 540,	20268	583	20353	563		482, 798
19705	854	19786	405	19910	465,		730, 817	20270	516,	20355	602	20440	788
19706	854	19787	569,		481, 798	20188	470,		540, 655	20356	619	20443	439,
19711	854		494, 539	19926	636		481, 729	20271	92, 98,	20358	601		482, 795
19712	854	19788	569,	19927	381	20189	427, 481		129, 132	20359	575,	20444	468, 482
19713	854		493, 539	19928	637	20190	468, 481	20272	661		513, 540	20446	106, 108
19714	854	19790	425, 481	19929	637	20191	604	20273	514, 540,	20360	427, 482	20448	184
19715	854	19793	618	19930	636	20192	424, 481		606, 625	20362	430, 482	20449	184
19716	854	19795	580, 271	19931	640	20193	603	20274	455, 481	20363	499,	20450	140
19719	450,	19797	780	19932	640	20194	603	20275	618		540, 610	20452	552
	480, 796	19798	72	19933	640	20195	614, 724	20276	402	20364	92, 100	20453	275
19720	441,	19800	559	19939	640	20196	496,	20277	249	20365	574,	20454	275
	480, 795	19801	573, 500,	19941	640		540, 800	20279	472, 481		509, 540	20455	93, 101,
19721	788		607, 626, 539	19944	637	20199	727	20280	557	20366	424, 482		129, 135
19722	783	19802	455, 481	19945	637	20201	726	20281	429, 481	20367	511,	20457	524,
19723	644	19804	470, 481	19947	635	20202	726	20282	259		540, 605		540, 628
19724	441,	19807	824	19952	635	20203	532,	20283	259	20373	69	20458	521,
	480, 751	19810	455, 481	19954	637		540, 731	20284	259	20374	69		540, 627
19725	591	19812	639	19955	637	20205	727	20285	259	20375	91, 95	20462	275
19726	568,	19813	251	19957	637	20206	233	20286	259	20376	92, 99	20464	565
	496, 539	19816	400	19958	637	20207	233	20287	259	20377	561	20465	507,
19728	441,	19817	400	19966	639	20209	220	20289	259	20378	549		540, 722
	480, 795	19819	404	19970	635	20210	220	20291	259	20380	273, 649,	20466	552, 597
19729	445, 480,	19820	560	19972	636	20211	220	20292	259		680, 714, 725,	20468	618
	709, 793	19821	565	19973	636	20212	217	20294	259		739, 756, 806	20469	714, 805
19730	680	19822	561	19975	640	20213	217	20295	259	20381	444, 482,	20470	714, 805
19731	461,	19823	612	19976	639	20214	218	20296	259		669, 737, 748	20471	581, 271
	480, 750	19826	172	19977	640	20215	218	20298	259	20382	92, 99,	20472	141,
19732	553	19831	717	19985	636	20216	218	20299	259		129, 133		645, 668
19734	644, 668	19834	427, 481	20008	637	20217	219	20300	259	20383	308	20473	452, 482,
19735	143, 757	19836	418, 481	20030	635	20218	219	20301	106, 109	20386	663		710, 796
19736	746	19837	427, 481	20034	637	20219	219	20303	667	20387	663	20474	294
19737	661	19838	612	20038	640	20220	218	20308	630	20388	521,	20475	220
19739	523,	19840	786	20089	638	20221	219	20309	405		540, 655	20476	92, 98,
	539, 804	19842	423,	20090	635	20222	219	20310	502,	20389	253		129, 132
19740	643, 662		481, 793	20092	636	20223	219		540, 606	20390	780	20477	270
19741	667	19843	781	20110	635	20224	219	20311	417, 481	20391	780	20478	227
19742	706, 787	19844	639	20111	640	20225	219	20313	639	20392	602	20479	316
19743	718	19845	432, 481	20112	640	20226	218	20314	496,	20393	596	20480	316
19744	422,	19846	432, 481	20114	640	20227	219		540, 730	20394	639	20481	563
	481, 670	19847	571,	20115	640	20230	219	20315	728	20395	585	20482	611
19745	735		525, 539	20116	640	20231	220	20316	430, 481	20396	585, 613	20483	610
19746	415,	19849	511,	20118	640	20232	402, 556	20318	557	20397	581, 271	20484	226
	481, 646		539, 606	20122	636	20233	527,	20319	427, 481	20399	421, 482	20485	588
		19850	438, 481	20123	636		540, 606	20320	233	20400	599	20486	226



## NUMERICAL INDEX

Auveco No.	Page No.	Auveco No.	Page No.	Auveco No.	Page No.	Auveco No.	Page No.	Auveco No.	Page No.	Auveco No.	Page No.	Auveco No.	Page No.
20487	226	20559	459, 482,	20629	308	20721	267	20803	397	20884	564	20956	143, 175,
20488	226		711, 797	20630	614	20722	267	20804	397	20885	561		715, 807
20489	226	20560	233	20631	575,	20728	267	20807	277	20886	689	20957	716
20490	226	20561	251		512, 541,	20729	267	20808	560	20887	623	20958	716
20491	226	20562	587	20632	576, 523,	20730	267	20809	560	20888	574, 512,	20959	462, 483,
20492	226	20563	469, 482		608, 541	20734	520,	20810	559		627, 541		647, 672
20493	226	20564	522, 540,	20633	464,		541, 655	20811	560	20889	576, 523,	20960	716
20494	226		649, 677		482, 798	20735	470,	20813	746		608, 541	20961	689, 741
20495	226	20565	736	20634	456, 482		482, 729	20814	458, 482	20890	533,	20962	619
20496	226	20566	684	20635	553	20736	691, 745	20815	221		541, 629	20963	531,
20497	226	20567	682, 697	20636	493,	20737	661	20816	221	20891	566		541, 629
20498	226	20568	683		541, 731	20738	705, 778	20817	600	20892	567,	20964	620
20499	226	20570	140,	20637	516,	20739	524,	20818	224		532, 541	20965	602
20500	226		681, 734		541, 731		541, 625	20819	225	20893	417, 483	20966	511,
20501	226	20571	449,	20638	520, 541,	20740	311	20823	848	20895	785		541, 626
20502	834		482, 738		654, 731	20741	311	20825	563	20896	275	20967	525,
20503	834	20572	735	20639	494,	20742	585	20826	575,	20897	726		541, 628
20504	834	20573	736		541, 730	20743	777		514, 541	20898	230	20968	601
20505	834	20574	836	20640	494,	20744	777	20827	622	20899	229	20970	94, 130,
20506	834	20575	463, 482,		541, 730	20746	280	20828	621	20900	203, 853		137, 579,
20507	834		711, 798	20641	731	20747	215	20829	454, 482	20901	222		104, 610, 629
20508	834	20576	449,	20642	449,	20748	215	20830	309	20902	849	20971	308
20509	834		482, 795		482, 729	20749	215	20831	439, 482	20903	849	20972	560
20510	834	20577	568, 515,	20645	732	20750	223	20834	311	20905	850	20973	560
20511	834		541, 712, 803	20647	728	20751	223	20836	400	20906	847	20974	560
20512	834	20578	556, 781	20649	142, 732	20752	223	20837	245	20907	847	20976	560
20514	582	20579	718	20650	142, 733	20753	526,	20838	252	20908	517, 541,	20977	602
20515	466, 482	20580	499, 541,	20651	142, 733		541, 754	20839	248		777, 804	20979	600
20516	519,		626, 738	20653	656, 732	20754	297	20840	251	20909	503,	20981	601
	540, 607	20581	619, 736	20654	272, 732	20755	515,	20841	247		541, 731	20982	622
20518	527,	20582	174	20655	273, 732		541, 723	20842	250	20910	504,	20983	460,
	540, 609	20583	222	20656	727	20756	562	20843	249		541, 677		483, 720
20521	563	20585	259	20657	726	20757	708, 789	20844	247	20912	392	20984	716
20523	621	20587	259	20659	727	20758	707, 789	20845	251	20914	392	20986	519,
20524	618	20588	259	20660	707	20759	282	20846	251	20915	392		541, 676
20525	619	20589	259	20661	703	20760	438, 482	20848	245	20916	392	20988	574, 510,
20526	631	20590	259	20663	602	20761	424, 482	20849	248	20917	392		626, 541
20527	553	20591	259	20665	581, 271	20763	621	20850	252	20918	392	20989	574, 512,
20528	416, 482	20593	259	20666	571,	20764	690, 742	20851	252	20919	392		608, 541
20529	553	20595	260		494, 541	20765	468, 482	20852	249	20920	392	20990	575, 514,
20530	597	20596	260	20667	618	20766	521,	20853	247	20922	390		627, 542
20531	423, 482	20598	260	20668	463, 482,		541, 627	20854	267	20923	532, 541,	20991	576,
20532	596	20599	260		692, 750	20767	526,	20855	267		604, 722		522, 542
20534	714, 806	20600	260	20669	465, 482,		541, 628	20856	267	20924	811	20992	576,
20535	714, 806	20601	260		692, 750	20768	513,	20857	267	20925	811		523, 542
20536	225	20602	660	20670	459,		541, 627	20859	259	20926	424, 483	20993	577, 528,
20537	852	20603	658		482, 751	20769	619	20860	583	20927	112, 595		608, 542
20538	852	20604	690, 744	20671	445,	20770	446, 482	20862	599	20928	393	20994	577,
20539	852	20605	703		482, 748	20771	623	20863	577,	20931	513,		528, 542
20540	852	20606	140	20672	452,	20773	727		525, 541		541, 803	20995	456, 483
20541	433, 482	20607	561		482, 749	20774	562	20864	549	20932	452,	20996	456, 483
20542	504,	20608	520,	20675	587, 614,	20775	560	20865	560		483, 720	20998	457, 483
	540, 573		541, 676		630, 634	20776	614	20866	474, 483	20933	812	20999	457, 483
20543	448, 482,	20609	435, 482,	20677	658	20782	662	20868	564	20934	562	21000	601
	686, 698		646, 670	20678	585, 613	20783	660	20869	574, 507,	20935	563	21001	139
20544	633	20610	466,	20680	105, 108	20784	660		541, 713, 802	20936	603, 715	21002	210
20545	510,		482, 673	20681	259	20785	660	20870	622	20937	113	21003	210
	540, 605	20611	449,	20683	260	20786	745	20872	588	20938	551	21004	210
20546	612		482, 671	20687	780	20787	306	20873	740	20942	400	21005	211
20547	246	20612	666	20688	780	20788	305	20874	431,	20943	569,	21006	237
20548	246	20613	511,	20689	841	20789	232		483, 708		497, 541	21007	172
20549	249		541, 753	20690	841	20790	746	20875	704	20944	456, 483	21010	516,
20550	246	20614	741	20691	841	20791	840	20876	704	20945	638		542, 804
20551	233	20615	433, 482	20694	840	20792	397	20877	704	20948	525,	21011	500,
20552	233	20616	468, 482	20695	840	20793	397	20878	426, 483,		541, 625		542, 801
20553	233	20618	216	20698	396	20794	397		708, 790	20949	468, 483	21012	452, 483,
20554	233	20620	259	20700	622	20795	397	20879	463,	20950	565		710, 796
20555	233	20621	259	20702	267	20796	397		483, 729	20951	564	21013	564
20556	93, 102,	20623	630	20705	267	20797	397	20880	574,	20952	561	21015	707, 786
	130, 135		423, 482	20706	267	20798	397		511, 541	20953	519, 541,	21016	782
20557	93, 103,	20625	431, 482	20712	267	20799	397	20881	450, 483		693, 754	21017	142,
	130, 136	20626	311	20715	267	20800	397	20882	445,	20954	644, 667		693, 756
20558	459, 482,	20627	306	20717	267	20801	397		483, 669	20955	713, 804	21019	632
	711, 797	20628	306	20720	267	20802	397	20883	583				

# NUMERICAL INDEX

Auveco No.	Page No.	Auveco No.	Page No.	Auveco No.	Page No.	Auveco No.	Page No.	Auveco No.	Page No.	Auveco No.	Page No.	Auveco No.	Page No.
21021	524, 542, 625	21103	491, 542, 800	21160	689	21226	452, 484, 795	21291	740	21354	278	21415	473, 484, 817
21022	403	21104	497, 542, 801	21161	565	21227	434, 484	21292	685	21355	273, 688	21416	808
21023	474, 483	21105	448, 483, 729	21162	783	21228	432, 484	21293	277	21356	684	21417	646, 671
21024	507, 542, 608, 722	21106	233	21164	580	21229	439, 484, 691, 747	21294	516, 542, 803	21357	708	21418	305
21025	619, 737	21107	451, 483, 646, 671	21165	597	21230	601	21295	442, 484, 747	21358	708	21419	661
21026	426, 483	21109	660	21166	235	21231	619	21296	443, 484, 791	21359	143, 715, 807	21420	524, 543, 776
21027	584	21110	509, 542, 723	21168	638	21232	685	21297	518, 542, 676	21360	463, 484, 687	21421	432, 484, 772
21028	297	21111	690, 744	21169	469, 483	21233	491, 542, 688	21300	597	21361	578, 528, 543, 754	21422	516, 543, 775
21033	242	21112	569, 499, 542	21170	649, 680	21234	782	21301	428, 484	21362	596	21423	400, 650
21036	564	21113	308	21171	716	21235	782	21302	580	21363	696	21424	223
21037	491, 542, 730	21114	306	21172	496, 542, 604	21236	617	21303	419, 484, 669	21364	453, 484	21425	690
21038	682	21116	276	21173	521, 542, 648, 676	21237	789	21304	597	21365	450, 484	21426	138
21040	145, 177	21117	465, 483, 738	21174	601	21238	530, 542, 571	21305	272, 656, 725, 732, 734, 820	21366	525, 543, 804	21427	524, 543, 625
21041	281	21118	522, 542, 724	21175	621	21239	596	21306	599	21367	743	21428	552
21044	502, 542, 730	21119	499, 542, 801	21176	579, 527, 542	21240	460, 484	21307	446, 484, 719	21368	595	21429	650
21046	311	21120	542, 801	21177	565	21241	431, 484	21308	642, 660	21369	778	21430	650
21047	278	21121	739	21178	275	21242	562	21309	755	21370	564	21431	656, 732
21048	120	21122	91, 96, 128, 131	21179	275	21244	683	21310	273, 630	21371	697	21432	650
21049	120	21123	511, 542, 802	21180	275	21245	315	21311	508, 542, 752	21372	699	21433	726
21050	120	21124	313	21181	105, 110	21246	570, 494, 542	21312	682	21373	562, 622	21434	726
21051	120	21125	437, 483	21182	110	21247	466, 484	21313	433, 484	21374	527, 543, 628	21435	235
21052	120	21126	611	21183	110	21248	428, 484	21314	704	21375	566	21436	235
21053	120	21127	611	21184	310	21249	492, 542, 800	21315	313	21376	580	21437	235
21054	120	21128	561	21185	594	21250	468, 484	21316	558	21377	144, 688, 700	21438	235
21055	120	21129	562	21186	659	21251	526, 542, 819	21317	209	21378	469, 484	21439	310
21056	120	21130	468, 483, 647	21187	583	21253	422, 484, 790	21318	746	21379	432, 484	21440	315
21059	467, 483, 647, 673	21131	468, 483, 647	21188	459, 483, 687, 698	21254	448, 484, 793	21319	602	21380	437, 484, 685, 697	21441	726
21064	682	21132	783	21189	469, 483	21255	705	21320	307	21381	437, 484, 685, 697	21442	629
21066	685, 697	21133	782	21190	503, 542, 677	21256	834	21321	683	21382	436, 484, 685, 697	21443	432, 485
21067	688	21134	520, 542, 753	21191	787	21257	426, 484	21322	772	21383	456, 484	21444	590
21068	684	21135	279	21192	518, 542, 693, 723, 754	21258	276	21323	690, 743	21384	553	21445	611
21069	106, 684, 696	21136	683	21193	779	21259	273, 756	21324	503, 542, 802	21385	433, 484	21446	297
21070	460, 483, 687, 698	21137	458, 483, 734	21194	779	21260	210	21325	281	21386	433, 484	21447	810
21071	781	21138	464, 483, 734	21195	400	21261	210	21326	297	21387	583	21448	809
21072	589	21139	460, 483, 734	21196	587	21262	210	21327	498, 543, 688	21388	649, 680	21449	809
21074	839	21140	498, 542, 738	21197	588	21263	210	21328	689	21389	809	21450	451, 485, 815
21075	839	21141	509, 542, 673	21198	600	21264	210	21329	787	21390	493, 543, 818	21451	496, 543, 818
21076	839	21142	437, 483, 734	21199	420, 483	21265	210	21330	422, 484, 791	21391	426, 484, 814	21452	526, 543, 819
21077	839	21143	437, 483, 734	21200	564	21266	210	21331	467, 484	21392	473, 484, 817	21453	779
21078	839	21144	473, 483, 816	21201	513, 542, 713	21267	210	21332	438, 484	21393	810	21454	520, 543, 677
21080	154	21145	817	21202	600	21268	210	21333	467, 484	21394	810	21455	821
21081	106, 109	21146	508, 542, 699	21203	582, 272	21269	210	21334	438, 484	21395	810	21456	696
21082	307	21147	689	21204	642	21270	210	21335	566	21396	810	21457	415, 485, 673
21084	707	21148	601	21205	667	21271	210	21336	714, 805	21397	813	21458	144, 693, 757
21085	740	21149	459, 483, 672	21206	463, 483, 673	21272	210	21337	807	21398	473, 484, 816	21459	726
21086	517, 542, 627, 731	21150	684	21207	659	21273	210	21338	428, 484	21399	811	21460	727
21087	465, 483, 673	21151	706, 786	21208	461, 483, 647, 672	21274	211	21339	226	21400	579, 527, 543	21461	726
21088	452, 483	21152	853	21209	645	21275	210	21340	226	21401	221	21462	727
21089	510, 542, 605	21153	622	21210	245, 255	21276	210	21341	226	21402	293	21463	726
21090	428, 483	21154	621	21211	434, 484, 793	21277	211	21342	226	21403	589	21464	726
21091	455, 483	21155	623	21212	240	21278	210	21343	226	21404	590	21465	381
21092	588	21156	562	21213	619	21279	210	21344	226	21405	590	21466	233
21093	278	21157	565	21214	611	21280	210	21345	226	21406	590	21467	233
21094	664	21158	558	21215	613	21281	210	21346	456, 484	21407	633	21468	233
21095	663	21159	751	21216	661	21282	211	21347	551	21408	633	21469	233
21096	663			21217	783	21283	211	21348	531, 543, 629	21409	459, 484, 797	21470	659
21097	742			21218	492, 542, 800	21284	582	21349	420, 484, 697	21410	788	21471	381
21098	510, 542, 605, 624			21219	602	21285	740	21350	420, 484, 697	21411	454, 484, 721	21472	233
21099	622			21220	240, 255	21286	314	21351	586	21412	484, 717	21473	233
21101	639			21221	783	21287	432, 484	21352	278	21413	463, 484, 692, 750	21474	233
21102	463, 483, 711, 798			21222	597	21288	432, 484, 749	21353	278	21414	463, 484, 692, 750	21475	233
				21223	622	21289	464, 484, 750					21476	233
				21224	597	21290	586					21477	503, 543, 677
				21225	509, 542, 803							21478	810
				21226	586							21479	513, 543, 818
												21480	811
												21481	809



## NUMERICAL INDEX

Auveco No.	Page No.	Auveco No.	Page No.	Auveco No.	Page No.	Auveco No.	Page No.	Auveco No.	Page No.	Auveco No.	Page No.	Auveco No.	Page No.
21482	526, 543, 819	21540	143, 178, 770	21589	419, 485, 772	21644	589	21697	704	21756	425, 486	21804	418,
21483	819	21541	93, 101,	21590	772	21645	500, 544, 654	21698	705	21757	445,	21805	486, 766
21484	696	21542	130, 135	21591	451,	21646	693, 756	21699	703	21758	486, 652	21806	429,
21485	820	21543	242	21592	485, 773	21647	275	21700	645, 668	21759	447,	21807	486, 767
21487	591	21544	644, 663	21593	518,	21648	275	21701	459, 486,	21760	486, 814	21808	429,
21488	450, 485	21545	706, 786	21594	543, 775	21649	275	21702	692, 750	21761	809	21809	486, 767
21489	453, 485	21546	520, 543,	21595	497,	21650	279	21703	509, 544,	21762	809	21810	509,
21490	240,	21547	693, 753	21596	543, 774	21651	517,	21704	713, 802	21763	651	21811	544, 769
	245, 254	21548	703, 778	21597	517,	21652	517,	21705	508,	21764	651	21812	416,
21491	809	21549	508, 543,	21598	543, 775	21653	544, 676	21706	544, 605	21765	651	21813	486, 759
21492	810	21550	713, 802	21599	521, 543,	21654	435,	21707	440, 486,	21766	651	21814	428,
21493	809	21551	415, 485,	21600	713, 804	21655	485, 670	21708	645, 674	21767	650	21815	486, 760
21494	470,	21552	709, 794	21601	662	21656	780	21709	440, 486,	21768	650	21816	525,
	485, 816	21553	21554	21592	235	21657	296	21710	645, 674	21769	650	21817	544, 763
21495	451, 485,	21554	461,	21593	235	21658	296	21711	486, 520,	21770	650	21818	517,
	767, 815	21555	485, 672	21594	235	21659	700	21712	648, 676	21771	650	21819	544, 763
21496	450,	21556	485, 795	21595	503,	21660	498, 544,	21713	440, 486,	21772	417,	21820	519, 544,
	480, 815	21557	438, 485,	21596	543, 628	21661	738, 774	21714	645, 674, 794	21773	486, 701	21821	763, 769
21497	447,	21558	710, 794	21597	235	21662	733	21715	473,	21774	770	21822	763
	485, 813	21559	273, 806	21598	235	21663	421,	21716	486, 817	21775	770	21823	461, 486,
21498	811	21560	461,	21599	235	21664	485, 720	21717	733	21776	642, 660	21824	761, 768
21499	652, 728	21561	485, 672	21600	235	21665	492,	21718	493,	21777	440, 486,	21825	812
21500	518,	21562	642, 660	21601	111	21666	544, 721	21719	544, 730	21778	645, 674	21826	812
	543, 775	21563	660	21602	111	21667	491,	21720	705, 782	21779	93, 100,	21827	821
21501	527,	21564	642, 659	21603	111	21668	544, 721	21721	311	21780	129, 134	21828	820
	543, 776	21565	642, 661	21604	83, 108	21669	693, 756	21722	307	21781	652	21829	454,
21502	465,	21566	642, 659	21605	589	21670	277	21723	309	21782	435,	21830	486, 815
	485, 773	21567	422,	21606	806	21671	622	21724	733	21783	486, 652	21831	743
21503	565	21568	485, 720	21607	781	21672	574,	21725	76	21784	455,	21832	464, 486,
21504	563	21569	715	21608	143, 807	21673	564	21726	76	21785	486, 653	21833	762, 798
21505	705	21570	771	21609	144, 807	21674	600	21727	76	21786	522,	21834	732
21506	599	21571	521,	21610	144,	21675	600	21728	76	21787	544, 655	21835	690, 744
21507	599	21572	543, 776	21611	714, 807	21676	621	21729	76	21788	491, 654	21836	558
21508	809	21573	770	21612	143, 807	21677	574,	21730	76	21789	544, 655	21837	596
21509	449,	21574	438,	21613	741	21678	511, 544	21731	76	21790	490,	21838	565
	485, 814	21575	485, 774	21614	740	21679	422, 485	21732	76	21791	544, 654	21839	235
21510	811	21576	502,	21615	739	21680	551	21733	76	21792	521,	21840	235
21511	853	21577	543, 775	21616	499,	21681	460,	21734	76	21793	544, 655	21841	235
21512	809	21578	451,	21617	543, 752	21682	485, 672	21735	76	21794	651	21842	235
21513	820	21579	485, 773	21618	744	21683	462,	21736	76	21795	450,	21843	235
21514	819	21580	515,	21619	745	21684	485, 672	21737	76	21796	486, 815	21844	235
21515	814	21581	543, 776	21620	735, 778	21685	276	21738	76	21797	822	21845	235
21516	456,	21582	771	21621	501, 544,	21686	452,	21739	76	21798	458,	21846	621
	485, 815	21583	501,	21622	712, 801	21687	485, 720	21740	76	21799	486, 823	21847	658
21517	94, 104,	21584	543, 774	21623	706, 787	21688	423, 486	21741	76	21800	458,	21848	94, 104,
	130, 137, 579	21585	517,	21624	443,	21689	544,	21742	76	21801	543, 823	21849	130, 136
21518	553	21586	543, 775	21625	485, 791	21690	507, 624	21743	76	21802	454, 486,	21850	94, 103,
21519	417, 485,	21587	771	21626	415, 485,	21691	564	21744	76	21803	653, 734	21851	130, 136
	691, 749	21588	442,	21627	709, 794	21692	706	21745	623	21804	466, 486,	21852	93, 101,
21520	446,	21589	485, 772	21628	85	21693	740	21746	566	21805	653, 734	21853	129, 134
	485, 719	21590	460,	21629	771	21694	779	21747	589	21806	430,	21854	121, 123
21521	644, 668	21591	485, 773	21630	422,	21695	706	21748	589	21807	486, 814	21855	93, 101,
21522	601	21592	771	21631	485, 772	21696	459, 486,	21749	309	21808	599	21856	129, 134
21523	601	21593	527,	21632	515,	21697	711, 796	21750	718	21809	621	21857	814
21524	584	21594	543, 776	21633	544, 753	21698	715, 807	21751	93, 102,	21810	788	21858	728, 813
21525	513,	21595	771	21634	617, 735	21699	690, 745	21752	130, 135	21811	562	21859	657
	543, 713	21596	526,	21635	441, 485,	21700	691, 747	21753	583, 613,	21812	456, 486	21860	385
21526	403	21597	543, 776	21636	692, 751	21701	453,	21754	631, 700, 777	21813	454, 486,	21861	704, 781
21527	733	21598	771	21637	445, 485,	21702	486, 737	21755	93, 101,	21814	711, 796	21862	704, 781
21528	622	21599	518,	21638	709, 792	21703	428,	21756	129, 134	21815	661	21863	704
21529	574,	21600	543, 775	21639	666	21704	486, 777	21757	93, 101,	21816	708, 789	21864	496, 544,
	512, 543	21601	770	21640	661	21705	443,	21758	129, 134	21817	279	21865	712, 801
21530	507, 543,	21602	590	21641	693, 756	21706	486, 709	21759	704, 779	21818	312	21866	689, 746
	688, 699, 775	21603	707, 786	21642	460,	21707	419,	21760	235	21819	418,	21867	474,
21531	772	21604	458,	21643	485, 672	21708	486, 708	21761	235	21820	486, 765	21868	486, 652
21532	456, 485	21605	485, 774	21644	642, 660	21709	438,	21762	235	21821	486, 766	21869	701, 815
21533	828	21606	490,	21645	465,	21710	486, 709	21763	235	21822	418,	21870	474,
21534	381	21607	543, 774	21646	485, 692	21711	443,	21764	584	21823	486, 766	21871	486, 652
21535	457, 485	21608	782	21647	781	21712	486, 791	21765	584	21824	418,	21872	417,
21536	457, 485	21609	771	21648	782	21713	449,	21766	419,	21825	486, 719	21873	486, 701
21537	704	21610	771	21649	444, 485,	21714	486, 671	21767	486, 719	21826	486, 766		
21538	452,	21611	446,	21650	709, 791								
	485, 796	21612	485, 747										

# NUMERICAL INDEX

Auveco No.	Page No.	Auveco No.	Page No.	Auveco No.	Page No.	Auveco No.	Page No.	Auveco No.	Page No.	Auveco No.	Page No.	Auveco No.	Page No.
21856	518, 544, 713, 804	21900	427, 487, 767	21946	67	21996	454, 488, 816	22050	771	22098	820	22153	449, 488, 701
21857	705, 782	21901	65	21947	422, 487, 760	21997	473, 488, 817	22051	707, 785	22099	600	22154	700
21858	543, 544, 722	21902	66	21948	66	21998	461, 488, 750	22052	521, 545, 655	22100	519, 545, 575	22155	702, 545, 495
21859	502, 544, 730, 757, 823	21903	65	21949	440, 487, 759	21999	755	22053	431, 488	22101	525, 545, 818	22156	462, 488, 702
21860	525, 544, 713, 804	21904	65	21950	67	22000	739	22054	445, 488, 669	22102	707, 778	22157	464, 488, 695
21861	657	21905	427, 487, 766	21951	67	22001	444, 488, 792	22055	740	22103	435, 488, 710, 793	22158	782
21862	725	21906	427, 487, 767	21952	67	22002	65	22056	452, 488, 710, 795	22104	92, 98, 129, 133	22159	782
21863	682, 695, 735	21907	429, 487, 767	21953	67	22003	462, 488, 686, 698	22057	450, 488, 653	22105	145, 681, 178	22160	498, 545, 774
21864	308	21908	447, 487, 765	21954	67	22004	464, 488, 687	22058	496, 545, 604	22106	93, 102, 130, 136	22161	558
21865	93, 100, 129, 134	21909	447, 487, 765	21955	66	22005	462, 488, 687, 699	22059	745	22107	436, 488, 751	22162	438, 488
21866	65	21910	419, 487, 766	21956	66	22006	467, 488, 686	22060	439, 488, 691, 747	22108	810	22163	779
21867	65	21911	420, 487, 766	21957	66	22007	682, 695	22061	689, 740	22109	656	22164	121, 123
21868	427, 487, 760, 766	21912	420, 487, 766	21958	758, 764	22008	458, 488, 687, 698	22062	633	22110	92, 133, 100, 129	22165	665
21869	65	21913	420, 487, 766	21959	758, 764	22009	464, 488, 686, 698	22063	452, 488, 692, 749	22111	93, 101, 129, 134	22166	790
21870	447, 487, 765	21914	429, 487, 767	21960	758, 764	22010	682	22064	718	22112	519, 544, 648, 677	22167	559
21871	449, 487, 761, 767	21915	765	21961	759, 764	22011	685	22065	582	22113	145, 177, 657, 820	22168	435, 488
21872	56, 64, 66	21916	462, 487, 761, 768	21962	758	22012	469, 488, 688	22066	314	22114	142, 656	22169	275
21873	466, 487, 653, 768	21917	462, 487, 768	21963	758	22013	683	22067	313	22115	732	22170	834
21874	758, 764	21918	442, 487, 759, 765	21964	758	22014	696	22068	519, 545, 648, 677	22116	820	22171	834
21875	494, 544, 762, 769	21919	441, 487, 759, 765	21965	758	22015	683, 696	22069	519, 545, 648, 677	22117	585	22172	834
21876	511, 544, 752, 769	21920	442, 487, 759, 765	21966	763	22016	685	22070	92, 98, 129, 133	22118	235	22173	307
21877	419, 487, 760	21921	769	21967	490, 544, 762	22017	685, 697	22071	448, 488	22119	235	22174	591
21878	419, 487, 760	21922	769	21968	490, 544, 762, 768	22018	683	22072	531, 545, 714, 805	22120	235	22175	776
21879	446, 487, 759	21923	769	21969	501, 544, 763	22019	683	22073	448, 488, 708, 790	22121	586	22176	745
21880	446, 487, 759	21924	769	21970	495, 544, 762	22020	683	22074	145, 177	22122	313	22177	502, 545, 628
21881	491, 544, 762	21925	66, 67	21971	503, 544, 763	22021	558	22075	422, 488, 691, 749	22123	744	22178	495, 545, 604
21882	494, 544, 762, 769	21926	770	21972	492, 544, 762	22022	559	22076	689, 740	22124	600	22179	451, 488
21883	520, 544, 763	21927	770	21973	517, 544, 763	22023	314	22077	507, 545, 738	22125	491, 545, 712, 800	22180	424, 488
21884	467, 487, 762	21928	65, 66	21974	462, 487, 761	22024	559	22078	777	22126	514, 545, 803	22181	507, 545, 775
21885	814	21929	758, 764	21975	449, 487, 761, 768	22025	583	22079	777	22127	703	22182	246
21886	819	21930	742, 764	21976	464, 487, 762	22026	551	22080	559	22128	746	22183	249
21887	819	21931	758, 764	21977	450, 487, 761, 767	22027	563	22081	92, 99, 129, 133	22129	621	22184	840
21888	819	21932	764	21978	462, 487, 761	22028	619	22082	445, 488, 737	22130	660	22185	840
21889	819	21933	63, 65	21979	759	22029	563	22083	501, 545, 777	22131	657	22186	840
21890	812	21934	763, 770	21980	439, 487, 813	22030	92, 133, 100, 129	22084	651	22132	454, 488, 711, 796	22187	840
21891	434, 487, 817	21935	493, 487, 769	21981	436, 487, 813	22031	468, 488	22085	700	22133	451, 488	22188	840
21892	817	21936	416, 487, 760	21982	436, 488, 813	22032	741	22086	474, 488, 653	22134	275	22189	840
21893	454, 487, 815	21937	421, 487, 760	21983	415, 488, 814	22033	601	22087	656	22135	684	22190	840
21894	473, 487, 817	21938	420, 487, 760	21984	415, 488, 814	22034	469, 488	22088	308	22136	675	22191	840
21895	462, 487, 761, 768	21939	421, 487, 760	21985	811	22035	586	22089	307	22137	822	22192	840
21896	450, 487, 767	21940	420, 487, 760	21986	811	22036	562	22090	469, 488, 654	22138	822	22193	841
21897	765	21941	421, 487, 761	21987	812	22037	565	22091	473, 488, 652	22139	298	22194	841
21898	505, 544, 769	21942	442, 487, 759	21988	812	22038	600	22092	474, 488, 653	22140	650	22195	841
21899	65	21943	442, 487, 759	21989	492, 545, 818	22039	518, 545, 693, 752	22093	454, 488, 701	22141	650	22196	279
		21944	462, 487, 761, 768	21990	497, 545, 818	22040	584	22094	812	22142	651	22197	789
		21945	66	21991	449, 488, 815	22041	567, 532, 545	22095	525, 545, 818	22143	277	22198	756
				21992	816	22042	770	22096	707, 789	22144	657	22199	498, 545, 647, 675
				21993	810	22043	772	22097	714, 806	22145	700	22200	494, 545, 654
				21994	810	22044	771			22146	657	22201	651
				21995	454, 488, 816	22045	140			22147	657	22202	93, 101, 129, 134
						22046	447, 488, 772			22148	701	22203	817
						22047	527, 545, 776			22149	468, 488, 702	22204	280
						22048	459, 488, 774			22150	701	22205	467, 488, 773
						22049	511, 545, 723			22151	700	22206	451, 488, 773
										22152	459, 488, 702	22207	814
												22208	448, 489
												22209	776
												22210	432, 489, 772
												22211	444, 489, 709, 791
												22212	



## NUMERICAL INDEX

Auveco No.	Page No.	Auveco No.	Page No.	Auveco No.	Page No.	Auveco No.	Page No.	Auveco No.	Page No.	Auveco No.	Page No.	Auveco No.	Page No.
22213	788	22263	445,	22314	683	22374	68	22446	52	22518	51	71000	339
22214	443,		489, 669	22315	466, 489,	22375	68	22447	63	22519	55	71101	339
	489, 791	22264	312		687, 699	22376	68	22448	46	22520	55	71102	339
22215	781	22265	314	22316	682, 695	22377	68	22449	64	22521	50	71103	339
22216	813	22266	313	22317	682, 695	22378	68	22450	47	22522	57	71104	339
22217	780	22267	465, 489	22318	686	22379	67	22451	47	22523	58	71105	339
22218	746	22268	559	22319	686, 698	22380	67	22452	58	22524	50	71106	339
22219	512,	22269	460, 489	22320	436,	22381	68	22453	48	22525	59	71107	339
	545, 575	22270	517,		489, 686	22382	68	22454	60	22526	54	71108	339
22220	467, 489		545, 775	22321	436, 489,	22383	68	22455	61	22527	47	71109	339
22221	445,	22271	121, 123		685, 697	22384	68	22456	59	70000	339	71110	339
	489, 792	22272	612	22322	684, 696	22385	68	22457	61	70100	339	71111	339
22222	558	22273	664	22323	684, 696	22386	68	22458	46	70101	339	71112	339
22223	276	22274	690, 743	22324	684	22387	68	22459	49	70102	339	71113	339
22224	558	22275	755	22325	439, 489,	22388	68	22460	61	70103	339	71114	339
22225	564	22276	559		686, 697	22389	68	22461	49	70104	339	71115	339
22226	565	22277	585	22326	696	22390	68	22462	57	70105	339	71116	339
22227	511,	22278	453, 489	22327	53	22391	68	22463	51	70106	339	71117	339
	545, 608	22279	454, 489	22328	53	22394	53	22464	51	70107	339	71118	339
22228	555	22280	498,	22329	682, 696	22395	60	22465	51	70108	339	71119	339
22229	466,		545, 818	22330	53	22396	59	22466	51	70109	339	71120	339
	489, 654	22281	741	22331	54	22397	64	22467	51	70110	339	71121	339
22230	490,	22282	526,	22332	307	22398	59	22468	52	70111	339	71122	339
	545, 774		545, 724	22333	489, 309	22399	64	22469	52	70112	339	71123	339
22231	458,	22283	661	22334	710	22400	62	22470	54	70113	339	71124	339
	489, 816	22284	528,	22335	710	22401	50	22471	61	70114	339	71125	339
22232	122, 125		545, 609	22336	458, 489	22402	44, 167	22472	60	70115	339	71126	339
22233	433, 489	22285	462,	22337	446,	22403	44, 167	22473	61	70116	339	71127	339
22234	502,		489, 734		489, 686	22404	44, 167	22474	49	70117	339	71128	339
	545, 610	22286	445, 489,	22338	431,	22405	44, 167	22475	49	70118	339	71129	339
22235	813		691, 748		489, 814	22406	44, 167	22476	58	70119	339	71130	339
22236	451,	22287	691, 746	22339	531,	22407	44, 167	22477	48	70120	339	71131	339
	489, 729	22288	467,		545, 731	22408	44, 167	22478	61	70121	339	71132	339
22237	463,		489, 692	22340	822	22409	46, 295	22479	61	70122	339	71133	339
	489, 750	22289	584,	22341	44, 212	22410	47	22481	46	70123	339	71134	339
22238	491,		612, 631	22342	167	22411	63	22482	52	70124	339	71135	339
	545, 818	22290	773	22343	459,	22412	60	22483	55, 56	70125	339	71136	339
22239	744	22291	820		489, 773	22413	59	22484	49,	70126	339	71137	339
		22292	93, 101,	22344	281	22414	63		56, 57	70127	339	71138	339
22240	450, 489		130, 135	22345	741	22415	52	22485	55	70128	339	71139	339
22241	659	22293	121, 123	22346	703, 779	22416	57	22486	61	70129	339	71140	339
22242	659	22294	93, 101,	22347	500,	22417	64	22487	60	70130	339	71141	339
22243	450,		129, 134		545, 573	22418	63	22488	59	70131	339	71142	339
	489, 671	22295	94, 103,	22348	44	22419	53	22489	60	70132	339	71143	339
22244	454,		130, 136			22420	64	22490	59	70133	339	71144	339
	489, 701	22296	94, 103,	22349	497,	22421	64	22491	47	70134	339	71145	339
22245	474,		130, 136		545, 607	22422	48	22492	48	70135	339	71146	339
	489, 701	22297	685	22350	705, 781	22423	48	22493	49	70136	339	71147	339
22246	695	22298	652	22351	703, 779	22424	56, 62	22494	57	70137	339	71148	339
22247	695	22299	523,	22352	688	22425	46	22495	60	70138	339	71149	339
22248	513,		545, 699	22353	708	22426	63	22497	60	70139	339	71150	339
	545, 702	22300	684	22354	510,	22427	59	22498	56	70140	339	71151	339
22249	700		545, 626		545, 626	22428	44	22499	52	70141	339	71152	339
22250	470,	22301	689, 740	22355	438, 489	22429	58	22500	54	70142	339	71153	339
	489, 695	22302	439, 489	22356	438, 489	22430	48	22501	46	70143	339	71154	339
22251	453,	22303	494, 545,	22357	794	22431	49	22502	62	70144	339	71155	339
	489, 702		654, 734	22358	693, 756	22432	49,	22503	58	70145	339	71156	339
22252	451,	22304	611		599		50, 67	22504	56	70146	339	71157	339
	489, 729	22305	460,	22359	599	22433	51	22505	53	70147	339	71158	339
22253	509, 545,		489, 729	22360	46	22434	52	22506	54	70148	339	71159	339
	688, 699	22306	517,	22361	57	22435	53	22507	54	70149	339	71160	339
22254	448,		545, 731	22362	755	22436	47	22508	54	70150	339		
	489, 728	22307	727	22363	50	22437	46	22509	50	70151	339		
22255	691, 746	22308	813	22364	58	22438	53	22510	55	70152	339		
22256	526,	22309	461,	22365	51	22439	62	22511	56	70153	339		
	545, 695		489, 729	22366	54	22440	57	22512	55	70154	339		
22257	745	22310	437,	22367	52	22441	63	22513	57	70155	339		
22258	561		489, 728	22368	58	22442	63	22514	52	70156	339		
22259	455, 489	22311	744	22369	61	22443	51	22515	56	70157	339		
22260	820	22312	460,	22370	54	22444	64	22516	55	70158	339		
22261	689, 745		489, 698	22371	47	22445	63	22517	55	70159	339		
22262	659	22313	459, 489,	22372	47								
			687, 699	22373	48								

# FASTENER TERMINOLOGY

**Bolt:** Externally threaded, headed fastener. Difference between a bolt and a screw: a bolt is generally used through a hole with a mating nut. A screw is used in a threaded hole without a nut.

**Class of Thread:** A system to distinguish thread tolerance differences. Classes 1A, 2A, and 3A apply to external threads. 1B, 2B, and 3B apply to internal threads. Classes 2 and 3 apply to both external and internal threads.

**Crest:** Outermost tip of male thread from the fastener cylinder, or innermost tip of female thread.

**Driving Recess:** Recess in the fastener head designed to accept a driving tool.

**External Thread:** Male thread. Thread outside of the cylinder surface.

**Internal Thread:** Female thread. Thread on the inside surface of a cylinder or cone.

**Left-Hand Thread:** Thread that winds counter-clockwise from the starting end of a fastener.

**Right-Hand Thread:** Thread that winds clockwise from the starting end of a fastener (viewed from starting end).

**Major Diameter:** Largest diameter of a screw thread on a straight thread. It is the diameter of an imaginary cylinder which would pass through the crest of an external thread or the root of an internal thread.

**Minor Diameter:** On a straight thread it is the diameter of an imaginary cylinder bounding the root of an external thread or the crest of an internal thread.

**Nominal Diameter:** Basic diameter that determines the size and dimensional limits of fasteners.

**Pitch:** Distance from a point of a screw thread to a corresponding point on the next thread measured parallel to the axis.

**Screw:** Headed fastener which is externally threaded.

**Sems®:** Pre-assembled screw and washer assemblies. Washers are placed on screws before roll threading. Threads of larger diameter than the washer hole thus prevent the washer from slipping off the screw.

**Stud:** Threaded rod at both ends or for entire length.

**Tapping Screw:** Hardened thread screw made to cut or form its own mating thread in an untapped hole.

**Teks®:** Screw which drills its own hole and then threads in.





















**Thread Pitch:** Distance from the crest of one thread to the crest of another.

## PLATINGS AND FINISHES









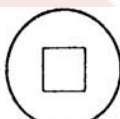

Finish	Color	Anti-Corrosion Properties	Characteristics and Uses	
<b>Black Oxide</b>	Black	Good (Interior Only): 8 Hour Salt Spray	Most Metals	Decorative finish. Used only on interior applications.
<b>Black Zinc</b>	Black	Excellent: 48 Hour Salt Spray	All Metals	Rich and lustrous. With or without lacquering.
<b>Cadmium</b>	Bright Silver- Gray Dull or Burnished	Very Good: 24 Hour Salt Spray	Most Metals	Non-porous metallic plating. Rich appearance, good rust resistance, low cost, good electrical conductivity. Bright silver-gray dull gray or black electroplated finish.
<b>Chromium (Chrome)</b>	Bright Blue-White	Excellent: 24 Hour Salt Spray	All Metals	Used when a beautiful finish is desired. Bright blue-white lustrous appearance. Electroplated.
<b>Dichromate Dip</b>	Rainbow	Excellent	All Metals	A yellow, brown, green or iridescent colored coating. Increases rust resistance. Add to Zinc or Cadmium plating.
<b>E-Coat</b>	Black	Excellent: 168 Hour Salt Spray	All Metals	Added protection containing corrosion inhibitors. Excellent for exterior applications.
<b>Iridite</b>	Green, Blue, Olive drab, Red, Bronze or Black	Excellent	All Metals	Coloring dip which adds rust resistance. Usually applied on Zinc or Cadmium.
<b>JS-500</b>	Chrome like luster	Excellent: 500 Hour Salt Spray	All Metals	Outstanding corrosion resistant finish that provides economical corrosion protection without adversely affecting dimensions.
<b>Mechanical Zinc</b>	Gray	Very Good: 48 Hour Salt Spray	All Metals	A chemical process of rust-proofing steel.
<b>Nickel</b>	Silver	Very Good: 24 Hour Salt Spray	All Metals	A hard, stable, dull white or bright burnished finish. Used for appliances and hardware.
<b>Parkerized</b>	Black	Excellent: 72 Hour Salt Spray	Ferrous Metals	Added protection when oiled with non-drying petroleum oil containing corrosion inhibitors. Good lubricity.
<b>Phosphating</b>	Dull, Gray, Black, or Blue	Excellent: 24 Hour Salt Spray	Ferrous Metals	A chemical process of rust-proofing steel.
<b>Passivating</b>		Excellent	Stainless Steels	For stainless steels. A nitric acid dip to remove foreign material and brighten finish.
<b>Zinc Electrogalvanized</b>	Gray	Very Good: 24 Hour Salt Spray	All Metals	Good rust resistance, appearance & low cost.
<b>Zinc Electroplated</b>	Blue to Blue-White-Gray	Very Good: 24 Hour Salt Spray	All Metals	Commonly used finish.





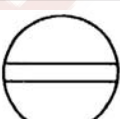
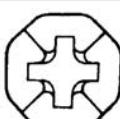













# HEAD STYLES

				
<b>Binding:</b> undercut unless otherwise specified. Not recommended for phillips recess	<b>Fillister:</b> deep slot used for counter bored holes	<b>Flat Fillister:</b> same as standard fillister without oval top	<b>Flat 82+:</b> used where flush surface is desired	<b>Flat 100+:</b> larger head than 82° used for thin metal soft plastic
				
<b>Flat Trim:</b> same as 82+ except diameter and countersink depth reduced	<b>Flat Undercut:</b> standard 82+ with lower 1/3 countersink removed for short screws	<b>Hexagon:</b> manufactured as trim hex or indented hex	<b>Hex Washer:</b> same as hexagon with washer section	<b>Oval:</b> same as flat head with rounded surface for appearance
				
<b>Oval Undercut:</b> similar to flat undercut with rounded surface	<b>Oval Trim:</b> same as oval, smaller diameter and countersink	<b>Pan:</b> recommended to replace round, truss binder	<b>Round:</b> general purpose (see pan head)	<b>Round Countersunk:</b> bolts only. Similar to flat head with no driving recess
				
<b>Round Washer:</b> same as round head with integral washer for bearing surface.	<b>Square:</b> bolts only. Large bearing surface for wrench tightening	<b>Square Countersunk:</b> for use on plow bolts	<b>Square (Set Screw):</b> recommended for high torque assembly	<b>Truss:</b> similar to round head with larger diameter (see pan head)

## HEAD STYLES

Cross-Recessed (Phillips)		Square Socket	
Pozi Drive		Slot & Square Socket	
Frearson		Indent Hex Washer	
Phillips & Slot		Indent Slotted Hex Washer	
Slot		Phillips Pyramid	
Cross-Slot		Clutch	
Torx®			

## POINT STYLES

Type AB	
Type 17	
Type BP	
Type A	
Type B	
Type BT(25)	
Type C	
Type T(23)	
Type D(1)	
Type F	
Type G	
Type BF	
Type U	
Type TT	
Type CA	
Dog Point	

# TAPPING SCREWS

Diameter, Head Size & Length Identification

## Oval Head Tapping Screws

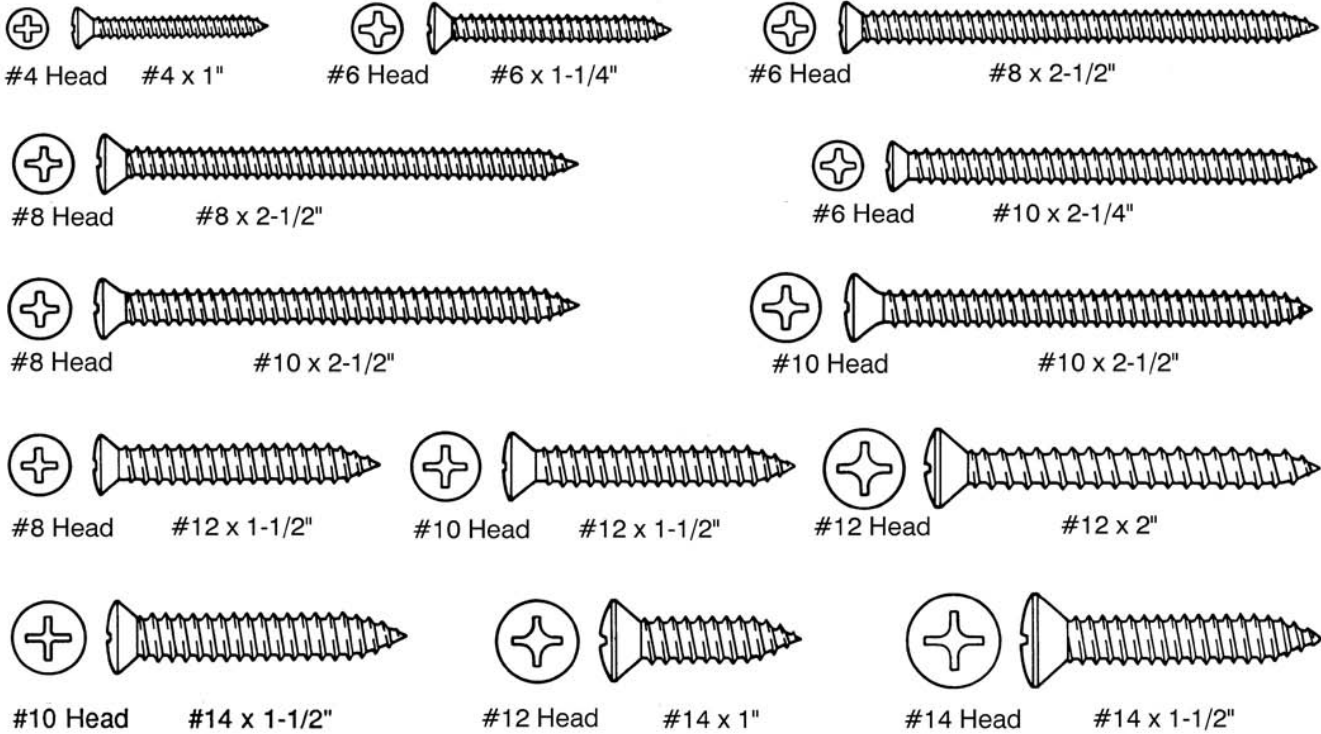

## Pan Head Tapping Screws

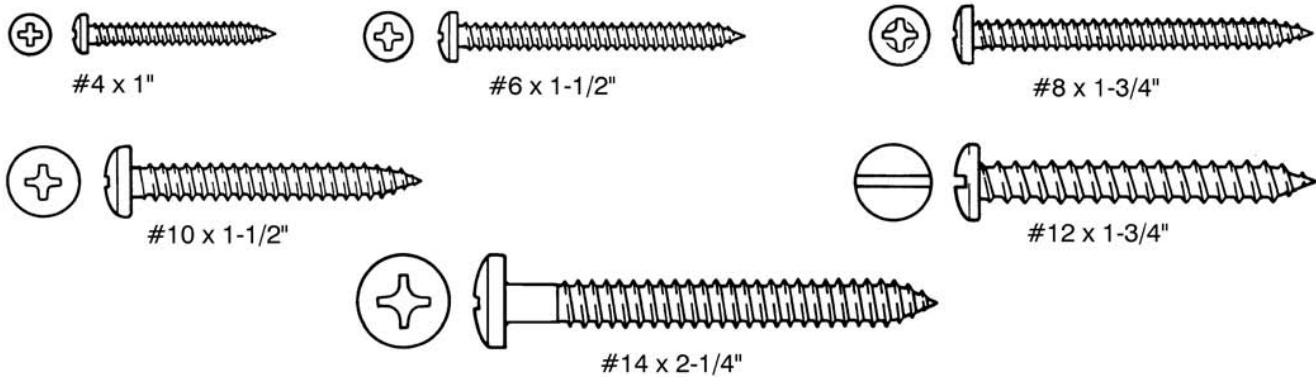

## How to Measure Tapping Screws

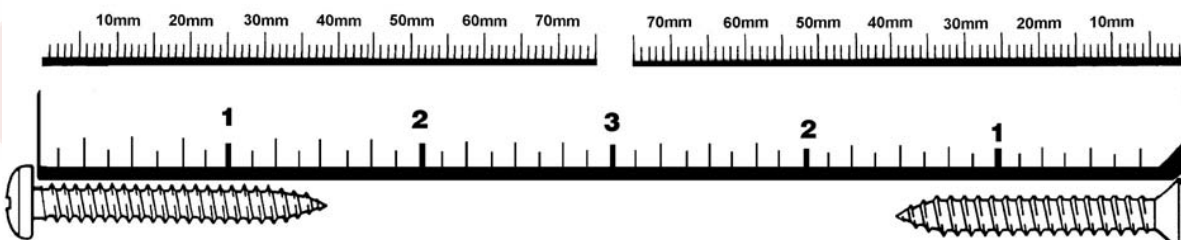

Place Pan Head, Hex Head or Hex Washer Head Screws at this end to measure the length (under the head)

Place Oval Head or Flat Head Screws in the blackened area to measure the length





## TAPPING SCREWS



**22348**

(Ford: W702413-S450B)  
Black Finish

M5-2.2 x 20mm  
Torx® Pan Head Sems®  
T30 Torx® Drive  
Washer Diameter: 20mm  
Ford Edge & Lincoln MKX 2015 - On

UNIT PACKAGE: 15

## BODY BOLTS

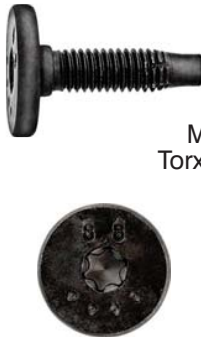

**22428**

(Ford: W708464-S450B)  
Black Zinc

M6-1.0 x 22mm (Includes Dog Point)  
Torx® Pan Head Body Bolt with Dog Point  
Type "F" Thread Cutting Feature  
T30 Torx® Drive  
Head Diameter: 17.5mm  
Class 8.8  
Ford F-150 &  
Super Duty Trucks 2015 - On

UNIT PACKAGE: 15

## JACK NUTS®

**22402**

Professional Jack Nut® Installation Tool  
Tool comes with 22403 (6 - 32 thread) installation rod  
Photo not actual size



An economical tool for rapidly installing Jack Nuts in any material. Takes interchangeable screw rods. Just screw rod into Jack Nut, push into hole, squeeze to set and remove. Sets all size Jack Nut Threaded Inserts.

UNIT PACKAGE: 1

### Jack Nut Installation Rods Use with 22402 Installation Tool



Auveco Part No.	Unit Pkg.	Thread
22403	1	6-32
22404	1	10-24
22405	1	1/4"-20
22406	1	4mm
22407	1	5mm
22408	1	6mm

## SPLICE CLIP



**22341**

(GM: 1839906)

Splice Clip  
Solderless & Non-Insulated  
Wire Range: Max. of 3 #12 Ga.

UNIT PACKAGE: 25

## DEFROSTER REPAIR

**DFK-1**

Rear Window Defroster  
Pro Plus Repair Kit



Professional's choice for the best all-in-one defroster repair kit. The Pro Plus Kit includes everything needed to troubleshoot and repair the easiest to the most challenging rear window defroster damage.

Contents:

- 1 DFK-2 Tab Bonding Kit (7g total net weight)
- 5 each of Replacement tabs: DFT-1, DFT-3, DFT-4 & DFT-5
- 5 DFC-1 Replacement Connectors
- 1 Test Lamp
- Detailed Instructions

UNIT PACKAGE: 1

**New**

## DEFROSTER REPAIR



### DFK-2 Defroster Tab Bonding Kit



DeFroster Pro's Tab Bonding adhesive contains over 80% silver. High silver content is needed to produce a highly conductive bond which is required in defroster tab repair. Two part adhesive cures quickly, bonds aggressively and makes the electrical and structural connection to the defroster one simple operation.

Contents:

- 2 part adhesive (7g total net weight)
- Sandpaper
- Stir sticks
- Detailed Instructions

UNIT PACKAGE: 1

### DFK-3

Defroster Tab Pack Plus Kit



Twenty of the most common factory defroster replacement tabs in a convenient kit. Compatible with vehicle defrosters including Ford, Honda, Toyota, Nissan, Subaru, GM, Chrysler & others.

Contents:

- 5 each of Replacement Tabs DFT-1, DFT-3, DFT-4 & DFT-5
- 5 Replacement Connectors DFC-1
- Detailed Instructions

UNIT PACKAGE: 1

## DEFROSTER REPAIR TABS

### DFT-1



Tab featured on Ford and Chrysler vehicles, but compatible with all defrosters and connectors

UNIT PACKAGE: 1\*

### DFT-2



Tab featured on GMC vehicles GMC Yukon, Suburban, Chevrolet Tahoe SUV, but compatible with all defrosters and connectors

UNIT PACKAGE: 1\*

### DFT-3



Tab featured on GM and Chrysler vehicles, but compatible with all defrosters and connectors

UNIT PACKAGE: 1\*

### DFT-4



Tab featured on Toyota, Honda and Nissan vehicles, but compatible with all defrosters and connectors

UNIT PACKAGE: 1\*

### DFT-5



Tab featured on Toyota, Honda and Subaru vehicles, but compatible with all defrosters and connectors

UNIT PACKAGE: 1\*

### DFT-6



Tab featured on Jeep vehicles. NOT compatible with all defrosters and connectors

UNIT PACKAGE: 1\*

\*5 Replacement Tabs Per Unit Package

### DFC-1



Easy to attach connectors crimp on the vehicles existing defroster wire and mate with all the defroster tabs.

Contains 5 each:  
Connectors and Connector Covers

UNIT PACKAGE: 1





## HARNESS CONNECTOR



### 22425

(Ford: 3U2Z-14S411-FKAA, 3U2Z-14S411-FKAB, 5U2Z-14S411-XA, WPT-793, WPT-859, WPT943)

Headlight  
Harness Connector  
Three 16 ga. TXL 8" Wire Leads  
For 9008/H13 Halogen Bulb  
**Replaces Auveco 20847**  
Ford 2004 - On

UNIT PACKAGE: 1

## DRAIN PLUGS

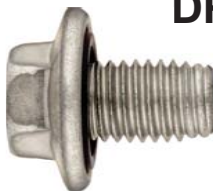

### 22360

(GM: 55577568)  
Zinc

Oil Drain Plug with Rubber Gasket  
Thread: M12-1.75  
Hex: 15mm with T45 Internal Drive  
Length Under Head: 17mm  
Washer Head O.D.: 26.5mm  
Chevrolet Sonic 2013 - On



UNIT PACKAGE: 1

## RIVETS

### 22409

Economy Rivet Gun  
Photo not actual size



With 3/32", 1/8", 5/32" and 3/16" nose pieces  
Overall Length: 10"  
Replacement accessories are not available

UNIT PACKAGE: 1

### 22458

Replacement Jaws for  
Auveco Rivet Gun 19066  
One Set of Jaws (2 Pieces)



UNIT PACKAGE: 1

## RIVETS

### 22437

(Hyundai: 14160-03103)



Front & Rear Bumper  
Specialty Rivet  
Diameter: 3.2mm (1/8")  
Flange Diameter: 6.3mm (1/4")  
Grip Range: 0.8mm - 4.8mm (.032" - .189")  
Black Aluminum Rivet & Steel Mandrel  
Hyundai Accent, Genesis, Santa Fe,  
Sonata & Veloster and Kia Borrego,  
K900, Rio, Sorento & Sportage 2006 - On

UNIT PACKAGE: 25

### 22481

(Hyundai: 14160-03133)



Front & Rear Bumper Specialty Rivet  
Diameter: 3.2mm (1/8")  
Flange Diameter: 6.3mm (1/4")  
Grip Range: 4.0mm - 7.9mm (.158" - .311")  
Black Aluminum Rivet & Steel Mandrel  
Hyundai Accent, Azera, Elantra, Equus, Santa Fe,  
Santa Fe Sport, Tucson & Veracruz and Kia Optima,  
Rondo, Sorento & Soul 2007 - On

UNIT PACKAGE: 25

### 22501

(Mazda: BN8F-50-355)



Front Bumper & Grille Specialty Rivet  
Diameter: 4mm (5/32")  
Flange Diameter: 8mm (5/16")  
Grip Range: 1mm - 13mm (3/64" - 33/64")  
Aluminum Rivet & Mandrel  
Mazda 3, 5, CX-3, CX-9, Miata & MX-5 2006 - On

UNIT PACKAGE: 15

### 22448

(Mazda: GHP9-50-355)



Bumper, Grill & Upper Bracket Specialty Rivet  
Diameter: 4mm (5/32")  
Flange Diameter: 8mm (5/16")  
Grip Range: 5.6mm - 9.6mm (.220" - .378")  
Black Aluminum Rivet & Mandrel  
Mazda 6 2014 - On

UNIT PACKAGE: 25

**New**

## RIVETS, HOG RINGS AND GENERAL MOTORS CLIPS & FASTENERS

**22436**

(Hyundai: 14160-05130)



Windshield Moulding Specialty Rivet  
Diameter: 4.8mm (3/16")  
Flange Diameter: 10mm (3/8")  
Grip Range: 1.6mm - 6.3mm (.063" - .250")  
Aluminum Rivet & Steel Mandrel  
Hyundai Azera, Equus, Genesis, Santa Fe  
& Sonata and Kia Amanti & Forte 2004 - On

UNIT PACKAGE: 25

**22371**

(Chrysler: 6036679AA)



Bumper Cover Specialty Rivet  
Diameter: 1/4"  
Grip Range: 0.080" - 0.375"  
Flange Diameter: 3/4"  
Aluminum Rivet & Steel Mandrel  
Dodge Nitro & Jeep Liberty 2011 - 2007

UNIT PACKAGE: 25

**22451**

(GM: 11546343)



Front & Rear Bumper Cover Specialty Rivet  
Diameter: 4mm (5/32")  
Grip Range: 5mm - 12mm (.197" - .472")  
Flange Diameter: 8mm (5/16")  
Aluminum Rivet & Mandrel  
Cadillac CT6 2016 - On  
Chevrolet Camaro 2012 - On

UNIT PACKAGE: 25

### HOG RING

**22450**

Galvanized Steel

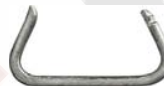

Small Hog Ring  
Inside Diameter: .740"  
Outside Diameter: .870"  
Wire Diameter: .073"

UNIT PACKAGE: 500

## GENERAL MOTORS CLIPS & FASTENERS



**22410**

(GM: 11610544)  
Zinc Organic

Front Fender Panel Nut  
Screw Size: M6-1.0  
Overall Height: 12mm  
Buick Allure, LaCrosse &  
Regal 2012 - On

UNIT PACKAGE: 10

**22491**

(GM: 11547582)  
Zinc Organic



Air Duct &  
Rear Bumper Bracket Nut  
Thread Size: M6-1.0  
Head Size: 8mm x 18mm  
Overall Height: 11mm  
Cadillac CT6, Chevrolet Silverado and  
GMC Acadia & Sierra 2016 - On

UNIT PACKAGE: 25



**22527**

(GM: 90230846; 94515248)  
Natural Nylon

Lower Door &  
Handle Interior Trim Grommet  
Screw Size: M4.8 (#10)  
Head Size: 9.5mm x 9.5mm  
Stem Length: 11mm  
Buick Regal 2014 - On  
Chevrolet Aveo 2011 - 2009

UNIT PACKAGE: 25



**22372**

(GM: 25832258)  
Black Nylon

Bumper, License Plate & Tail Light  
Screw Grommet with Sealer  
Screw Size: #14 (1/4")  
Head Size: 16mm x 16mm  
Stem Length: 8mm  
Fits into 10mm Square Hole  
Buick Enclave, Cadillac CT6,  
Chevrolet Traverse, GMC Acadia  
& Saturn Outlook 2007 - On

UNIT PACKAGE: 10



# GENERAL MOTORS CLIPS & FASTENERS

**New**



**22430**  
(GM: 22884291)  
White Nylon

Tail Light Grommet with Sealer  
Head Diameter: 18mm  
(Including Sealer)  
Stem Length: 15mm  
Overall Length: 18mm  
Fits into 10mm Hole  
Cadillac Escalade &  
GMC Yukon 2015 - On

UNIT PACKAGE: 10



**22373**  
(Not Available From O.E.M.)  
Black Nylon

Rocker Panel  
Moulding Clip  
Top Head Size: 12mm x 20mm  
Bottom Head Size: 12mm x 24mm  
Stem Length: 15mm  
Fits into 9mm Hole  
GMC 2016 - On  
Saturn Aura 2007 - On

UNIT PACKAGE: 15



**22492**  
(GM: 11547581)  
White Nylon

Body Side & Exterior Trim  
Moulding Clip with Sealer  
Top Head Size: 12mm x 20mm  
Bottom Head Diameter: 19mm  
(Including Sealer)  
Stem Length: 11mm  
Fits into 9mm Hole  
Cadillac XT5, Chevrolet Cruze  
& Impala 2014 - On

UNIT PACKAGE: 25



**22477**  
(Not Available from O.E.M.)  
Zinc

Interior Panel Fastener  
Width: 10mm  
Height: 12mm  
GM Silverado 2014 - On

UNIT PACKAGE: 15



**22453**  
(GM: 12375975)  
Pink Nylon

Rear Cargo Door Latch Rod Clip  
Rod Size: 4mm  
Fits into 6mm Hole  
Cadillac Escalade, Chevrolet Astro,  
Express Van, Suburban & Tahoe and  
GMC Safari, Savana, & Yukon 1996 - On

UNIT PACKAGE: 15

**22422**  
(Not Available From O.E.M.)  
Photo not actual size



Greaseable Stainless Steel Door  
Hinge Pin & Bushing Kit  
Repairs Two Front Door Hinges  
Cadillac ATS, CTS & STS 2005 - On  
Chevrolet Cruze & Camaro 2015 - 2009

UNIT PACKAGE: 1 Kit

**22423**  
(GM: 19355537)  
Photo not actual size

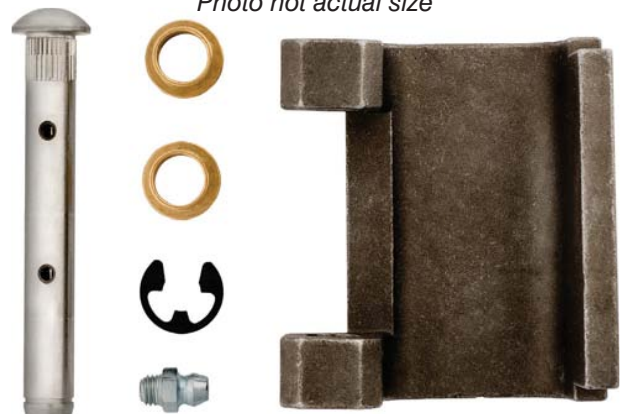

Greaseable Stainless Steel Door  
Hinge Pin, Bushing & Hinge Kit  
Repairs One Side Door Hinge  
GM Full Size Vans 1996 - On

UNIT PACKAGE: 1 Kit

**New**

## FORD AND CHRYSLER CLIPS & FASTENERS

### FORD CLIPS & FASTENERS



**22475**  
(Ford: W718369-S300)  
Black Nylon

Rear Lamp Grommet with Sealer  
Head Diameter: 18mm  
Stem Length: 13mm  
Overall Length: 15.6mm  
Ford F-150 2015 - On

UNIT PACKAGE: 10



**22474**  
(Ford: W717970-S300)  
Black Nylon

Rear Lamp Grommet  
Head Diameter: 18mm  
Stem Length: 16mm  
Overall Length: 18mm  
Ford F-150 2015 - On

UNIT PACKAGE: 10



**22493**  
(Ford: W719084-S300)  
Black Nylon

Trim Panel Retainer  
Head Diameter: 18mm  
Stem Diameter: 7.5mm  
Stem Length: 45mm  
Ford Mustang 2016 - On

UNIT PACKAGE: 25



**22484**  
(Mazda & Ford: E120-68-AB1;  
Mitsubishi: MR975267)  
Yellow Nylon

Pillar, Scuff Plate &  
Trim Panel Retainer  
Top Head Diameter: 13mm  
Middle Head Diameter: 16.5mm  
Bottom Head Diameter: 18mm  
Stem Diameter: 9.3mm  
Stem Length: 13mm  
Overall Length: 20mm  
Mazda 2 & 3 2015 - 2013  
Mitsubishi Montero 1999 - On  
Ford Escape (European Version)  
2006 - 2000

UNIT PACKAGE: 25

### FORD CLIPS & FASTENERS



**22431**  
(Ford: W716783-S300)  
Black Nylon

Hood Insulation Retainer  
Head Size: 25mm x 30mm  
Stem Length: 15mm  
Overall Height: 17mm  
Ford C-Max & Escape 2013 - On  
Lincoln MKC 2016 - On

UNIT PACKAGE: 25

### CHRYSLER CLIPS & FASTENERS



**22432**  
(Chrysler: 68093998-AA; Fiat: 71728806;  
Citroen & Peugeot: 856543)  
White Nylon

Body Side Moulding Clip with Sealer  
Top Head Size: 11mm x 12mm  
Bottom Head Size: 15mm x 19mm  
(Including the Sealer)  
Stem Diameter: 10.3mm  
Stem Length: 13mm  
Fiat, Citroen, Peugeot,  
Chrysler Postal Minivan Vehicles &  
Dodge Ram Promaster 2014 - On

UNIT PACKAGE: 25



**22461**  
(Chrysler: 55116997AB,  
55116997AA)  
White Nylon

Door Trim Panel Retainer  
Top Head Diameter: 16mm  
Middle Head Diameter: 18mm  
Bottom Head Diameter: 22mm  
Stem Diameter: 12mm  
Stem Length: 19mm  
Dodge Ram 2011  
Jeep Liberty 2006

UNIT PACKAGE: 25



**22459**  
(Chrysler: 6509761-AA)  
Black Nylon

Front Bumper  
Push-Type Retainer  
Head Diameter: 20mm  
Stem Length: 13.5mm  
Fits into 10mm Hole  
Dodge Ram &  
Jeep Cherokee 2010 - On

UNIT PACKAGE: 15





# CHRYSLER, BMW AND FIAT CLIPS & FASTENERS

## CHRYSLER CLIPS & FASTENERS



**22363**  
(Chrysler: 6510734-AA)  
Black Nylon

Front Bumper  
Push-Type Retainer  
Head Diameter: 21.5mm  
Stem Length: 14mm  
Fits into 12.5mm Hole  
Jeep Wrangler 2007 - On

UNIT PACKAGE: 15

## BMW CLIPS & FASTENERS



**22401**  
(BMW: 51-11-1-964-186)  
Black Nylon

Bumper Cover  
Push-Type Retainer  
Head Diameter: 15mm  
Stem Length: 20mm  
Fits into 6mm Hole  
BMW 3, 5, 7, X  
Z Series 2010 - 1983

UNIT PACKAGE: 25

## BMW CLIPS & FASTENERS

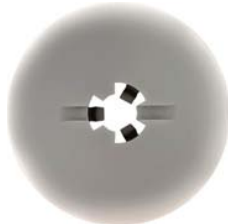

**22524**  
(BMW: 51-48-8-126-849)  
Gray Nylon

Sound Insulation Grommet  
Diameter: 30mm  
Stem Diameter: 9.5mm  
Overall Height: 9mm  
BMW 8 Series 1997 - 1994  
Mini-Copper 2014 - On

UNIT PACKAGE: 25

## FIAT CLIPS & FASTENERS



**22432**  
(Chrysler: 68093998-AA; Fiat: 71728806;  
Citroen & Peugeot: 856543)  
White Nylon

Body Side Moulding Clip with Sealer  
Top Head Size: 11mm x 12mm  
Bottom Head Size: 15mm x 19mm  
(Including the Sealer)  
Stem Diameter: 10.3mm  
Stem Length: 13mm  
Fiat, Citroen, Peugeot,  
Chrysler Postal Minivan Vehicles &  
Dodge Ram Promaster 2014 - On

UNIT PACKAGE: 25



**22521**  
(BMW: 52-20-1-964-201)  
Black Nylon

Seat Back Panel Clip  
Head Diameter: 14mm  
Stem Diameter: 8mm  
Stem Length: 25mm  
BMW 3, 5, 7 Series, X5  
& Z4 2016 - 1989

UNIT PACKAGE: 25



**22509**  
(BMW: 07-14-7-296-886)  
Black Nylon

Side Shield & Trim Retainer  
Head Diameter: 24mm  
Stem Diameter: 4mm  
Stem Length: 23mm  
T27 Drive  
BMW 3 Series 2012 - On

UNIT PACKAGE: 25

## STAY UP TO DATE WITH AUVECO'S NEW ITEMS

Auveco releases a set of our  
Hot New Items every other week.

To receive these bulletins please  
contact customer service:  
mail@auveco.com or 1-800-354-9816

We also have all previous and current  
bulletins posted on [www.auveco.com](http://www.auveco.com).

**New**

# HONDA AND ACURA CLIPS & FASTENERS



**22365**

(Honda: 90650-S5A-003)  
Clear Nylon

Rear Tail Light Grommet  
Head Diameter: 18.5mm  
Stem Length: 24mm  
Overall Length: 25mm

Acura MDX, RSX, TL, TSX 2016 - 2002  
Honda Civic & Fit 2007 - 2001

UNIT PACKAGE: 25



**22463**

(Honda: 91513-T0A-A01)  
Black Nylon

Wheel Well Arch Protective Liner  
Moulding Clip with Sealer  
Top Head Size: 10mm x 10mm  
Bottom Head Size: 10mm x 19mm  
Stem Length: 11.5mm  
Honda CR-V 2012 - On



UNIT PACKAGE: 25



**22464**

(Honda: 75316-TP6-A01)  
White Nylon

Lower Door Garnish  
Moulding Clip with Sealer  
Top Head Size: 10mm x 12mm  
Bottom Head Size: 16mm x 21mm  
Stem Length: 9mm  
Fits into 10mm Hole  
Honda Crosstour, Pilot &  
Ridgeline 2013 - On



UNIT PACKAGE: 25



**22465**

(Honda: 75315-TP6-A01)  
White Nylon

Lower Door Garnish  
Moulding Clip with Sealer  
Top Head Size: 12mm x 15mm  
Bottom Head Size: 14mm x 30mm  
Stem Length: 9mm  
Acura & Honda Crosstour, Pilot &  
Ridgeline 2013 - On



UNIT PACKAGE: 25



**22466**

(Honda: 91503-SWA-A01)  
White Nylon

Door Belt Moulding Clip  
Width: 20mm  
Length: 38mm  
Acura MDX 2014 - On  
Honda CR-V, Pilot &  
Ridgeline 2007 - On

UNIT PACKAGE: 25



**22443**

(Honda: 91513-TK8-A01)  
White Nylon

Rocker, Pillars,  
Floor & Exterior Trim  
Moulding Clip with Sealer  
Top Head Size: 12mm x 11mm  
Bottom Head Size: 13mm x 13mm  
Stem Length: 16mm  
Honda Odyssey &  
Ridgeline 2011 - On



UNIT PACKAGE: 25



**22433**

(Honda: 91514-SMG-E01)  
Gray Nylon

Trunk Garnish & Spoiler  
Moulding Clip with Sealer  
Top Head Size: 12mm x 17mm  
Bottom Head Size: 16mm x 17mm  
Stem Length: 21mm  
Acura RDX & Honda Accord,  
Accord Crosstour, Civic,  
CR-V & Pilot 2010 - On



UNIT PACKAGE: 15



**22518**

(Honda: 91504-SDA-003)  
Black Nylon

Hood Release Cable Clip  
Holds 5mm Diameter Cable  
Stem Length: 6.5mm  
Fits into 7mm Hole  
Honda Accord, Civic &  
Clarity 2003 - On

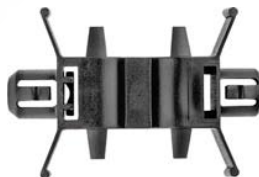

UNIT PACKAGE: 25



**22467**

(Honda: 91213-SZA-A01)  
Gray Nylon

Pillar Garnish Clip  
Top Head Size: 7mm x 7mm  
Bottom Head Size: 10mm x 19mm  
Stem Length: 6mm  
Honda Civic, Odyssey  
& Pilot 2009 - On



UNIT PACKAGE: 25



# HONDA AND ACURA CLIPS & FASTENERS

**New**



**22468**  
(Honda: 91514-SYP-003)  
White Nylon

Upper Side Sill  
Garnish Clip with Sealer  
Top Head Size: 18mm x 16mm  
Bottom Head Size: 22mm x 20mm  
Stem Length: 7mm  
Honda Fit & Fit EV 2014 - 2009

UNIT PACKAGE: 25



**22514**  
(Honda: 91512-SED-003)  
Black Nylon

Inner Fender Wheel Well Retainer  
Head Diameter: 18mm  
Stem Diameter: 4.1mm  
Stem Length: 16mm  
Honda Civic, Odyssey & Pilot 2005 - On

UNIT PACKAGE: 25



**22499**  
(Honda: 91560-TX4-A01)  
Yellow Nylon

Garnish Retainer with Sealer  
Top Head Diameter: 13mm  
Middle Head Diameter: 16.3mm  
Bottom Head Diameter: 18mm  
Stem Diameter: 9.5mm  
Stem Length: 13mm  
Acura ILX, MDX, RDX, RLX & TLX and  
Honda Civic, Clarity, CR-V, Fit, HR-V,  
Odyssey, Pilot & Ridgeline 2013 - On

UNIT PACKAGE: 25



**22469**  
(Honda: 90651-T3L-003)  
Black Nylon

Rear Bumper Garnish Retainer  
Top Head Diameter: 13mm  
Middle Head Diameter: 16.5mm  
Bottom Head Diameter: 18mm  
Stem Diameter: 9.3mm  
Stem Length: 14mm  
Acura NSX & RDX 2016 - On  
and Honda Accord & Civic 2017 - 2013

UNIT PACKAGE: 25



**22482**  
(Honda: 91514-TF0-003)  
Black Nylon

Rocker Moulding  
Push-Type Retainer  
Head Diameter: 18mm  
Stem Length: 13mm  
Fits into 9mm x 9mm Square Hole  
Honda Accord, Fit & Fit EV 2009 - On

UNIT PACKAGE: 25



**22446**  
(Honda: 91503-T1W-003)  
Gray Nylon

Bumper  
Push-Type Retainer  
Head Diameter: 20mm  
Stem Length: 13mm  
Fits into 10mm Hole  
Honda CR-V 2015 - On

UNIT PACKAGE: 15

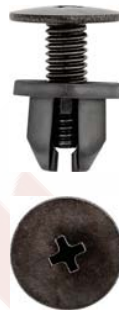

**22367**  
(Honda: 91514-TR3-A01)  
Black Nylon

Fender Liner Push-Type Retainer with  
Phillips Truss Head Stainless Steel Screw  
Screw Head Diameter: 15.5mm  
Nylon Grommet  
Head Diameter: 15mm  
Stem Length: 10mm  
Fits into 9mm Square Hole  
Honda Civic 2015 - 2014

UNIT PACKAGE: 5



**22434**  
(Honda: 91514-SLN-A01)  
Black Metal & Nylon

Front Fender Liner &  
Engine Cover Push-Type Retainer  
Phillips Truss Head Stainless Steel Screw  
Head Diameter: 15.5mm  
Grommet Head Size: 19.3mm x 19.3mm  
Stem Length: 10mm  
Fits into 10mm Hole  
Honda Fit & Insight 2014 - 2007

UNIT PACKAGE: 5



**22415**  
(Honda: 90667-TC0-U01-ZA)  
Black Nylon

Trunk Interior & Side Trim  
Push-Type Retainer  
Top Head Diameter: 15.5mm  
Bottom Head Diameter: 16mm  
Stem Length: 15mm  
Fits into 7mm Hole  
Acura ILX, TLX & TSX and Honda Accord,  
HR-V & Insight 2012 - On

UNIT PACKAGE: 25

**New**

## HONDA, ACURA, HYUNDAI AND KIA CLIPS & FASTENERS



**22394**

(Honda: 91561-TA0-A11,  
91561-TA5-A11)  
Metal & Green Nylon

Interior Trim, Pillars, Rocker  
Panel, Quarter Panel &  
Windshield Push-Type Retainer  
Head Diameter: 18mm  
Stem Length: 13mm  
Overall Length: 38mm  
Fits into 9mm Hole

Acura TL and Honda Accord, Civic, CR-Z,  
Fit, Odyssey, Pilot & Ridgeline 2008 - On

UNIT PACKAGE: 5



**22419**

(Honda: 90501-SDR-003)  
Black Nylon

Rocker Moulding & Mud Guard  
Push-Type Retainer  
Head Diameter: 20mm  
Stem Length: 21mm  
Fits into 10mm Hole  
Acura RDX, RL & RLX and  
Honda CR-V & Accord 2009 - On

UNIT PACKAGE: 25

## HYUNDAI AND KIA CLIPS & FASTENERS



**22505**

(Hyundai: 86825-26000)  
Black Nylon

Rear Fender Liner Plug  
Head Diameter: 30mm  
Overall Height: 16.5mm  
Black Nylon  
Hyundai Accent, Equus,  
Genesis, Santa Fe,  
Tucson & Veracruz 2011 - On  
Kia Sorento 2016 - 2011

UNIT PACKAGE: 15

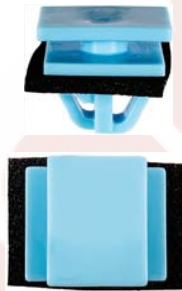

**22327**

(Hyundai: 87756-D3000)  
Blue Nylon

Door Moulding Clip with Sealer  
Top Head Size: 14mm x 18mm  
Bottom Head Size: 16mm x 20mm  
Stem Length: 10mm  
Hyundai Tucson 2016 - On

UNIT PACKAGE: 25



**22435**

(Hyundai: 84219-3L000)  
Black Nylon

Engine Under Cover &  
Rear Bumper Moulding Grommet  
Screw Size: M6-1.0  
Head Diameter: 20mm  
Stem Diameter: 14mm  
Stem Length: 7mm  
Overall Length: 9.5mm

Hyundai Azera, Equus, Genesis, Santa Fe & Sonata  
and Kia Forte, Optima & Rio 2010 - On

UNIT PACKAGE: 25



**22328**

(Hyundai: 87758-2S000)  
White Nylon

Rocker Moulding Clip  
with Sealer  
Head Size: 17mm x 25mm  
Stem Length: 14mm  
Hyundai Tucson 2016 - On

UNIT PACKAGE: 25



**22438**

(Hyundai: 87715-3K000)  
White Nylon

Door Trim, Roof & Spoiler  
Moulding Clip with Sealer  
Head Size: 9mm x 18.3mm  
Stem Length: 10mm  
Hyundai Azera, Equus, Genesis, Sonata,  
Tucson & Veloster and Kia Soul 2006 - On

UNIT PACKAGE: 25



**22330**

(Hyundai: 87759-2M000)  
Red Nylon

Rocker Panel Moulding Clip  
with Sealer  
Head Size: 17mm x 25mm  
Stem Length: 13mm  
Hyundai Genesis 2008 - On

UNIT PACKAGE: 50



# HYUNDAI AND KIA CLIPS & FASTENERS

**New**



**22331**  
 (Hyundai: 87759-3V000)  
 Yellow Nylon  
 Rocker Panel Moulding Clip with Sealer  
 Top Head Size: 12mm x 12mm  
 Bottom Head Size: 14mm x 20mm  
 Stem Length: 17mm  
 Hyundai Azera 2012 - On  
 Kia K900 2015 - On  
 UNIT PACKAGE: 25



**22470**  
 (Hyundai: 87716-2W000)  
 White Nylon  
 Fender, Body Side & Rocker  
 Moulding Clip with Sealer  
 Top Head Size: 10mm x 12mm  
 Bottom Head Size: 14mm x 20mm  
 Stem Length: 11mm  
 Hyundai Santa Fe 2012 - On  
 Kia Borrego 2011 - 2007 &  
 Kia Niro 2017 - On  
 UNIT PACKAGE: 50



**22508**  
 (Hyundai: 87756-2J000)  
 Pink Nylon  
 Side Garnish Moulding Clip with Sealer  
 Head Size: 13mm x 16mm  
 Stem Diameter: 11.5mm  
 Stem Length: 9mm  
 Hyundai Santa Fe & Tucson 2013 - On  
 UNIT PACKAGE: 15



**22500**  
 (Hyundai: 87756-3N100)  
 Yellow Nylon  
 Trunk Side Trim Moulding Clip with Sealer  
 Top Head Size: 12mm x 12mm  
 Bottom Head Size: 14mm x 18mm  
 Stem Diameter: 14.5mm  
 Stem Length: 16mm  
 Hyundai Equus 2015 - 2010  
 UNIT PACKAGE: 15



**22366**  
 (Kia: 87382-2W000)  
 Gray Nylon  
 Liftgate Moulding Clip with Sealer  
 Top Head Size: 10mm x 12mm  
 Bottom Head Size: 14mm x 20mm  
 Stem Length: 12mm  
 Overall Length: 16mm  
 Kia Cadenza, Optima &  
 Sorento 2013 - On  
 UNIT PACKAGE: 25



**22506**  
 (Hyundai: 81174-2L000)  
 Black Nylon  
 Hood Prop Rod Clip  
 Width: 20mm  
 Length: 24mm  
 Holds 8mm Rod  
 Hyundai Accent & Elantra 2008 - On  
 Kia Forte & Soul 2013 - 2009  
 UNIT PACKAGE: 15



**22507**  
 (Hyundai: 81174-21000,  
 81174-11011 & 81174-21010)  
 Black Nylon  
 Hood Prop Rod Clip  
 Holds 8mm Rod  
 Bottom Base Size: 20mm x 20mm  
 Stem Length: 9mm  
 Overall Length: 25mm  
 Hyundai Elantra, Sonata,  
 Tucson & Veloster 1997 - On  
 UNIT PACKAGE: 15



**22526**  
 (Hyundai: 82133-37000)  
 Red Nylon  
 Weatherstrip Retainer  
 Head Size: 5mm x 13mm  
 Stem Diameter: 5.5mm  
 Stem Length: 6mm  
 Hyundai Accent, Elantra,  
 Santa Fe & Sonata 2006 - 1993  
 UNIT PACKAGE: 50



**22370**  
 (Hyundai: 92485-2H000)  
 White Nylon  
 Rear Lamp Moulding  
 Retainer with Sealer  
 Top Head Diameter: 17mm  
 Bottom Head Diameter: 15mm  
 Stem Length: 11mm  
 Fits into 6mm Hole  
 Hyundai Accent, Elantra, Equus,  
 Genesis, Genesis Coupe, Santa Fe,  
 Sonata, Veloster & Veracruz  
 and Kia Forte, Optima, Rio  
 & Sportage 2007 - On  
 UNIT PACKAGE: 15

**New**

## LAND ROVER AND MAZDA CLIPS & FASTENERS

### LAND ROVER CLIPS & FASTENERS



**22485**

(Land Rover: DCE100560)  
Black Nylon

Tailgate Moulding Retainer  
Base Size: 17.3mm x 16.3mm  
Stem Diameter: 11mm  
Stem Length: 15mm  
Overall Height: 18.5mm  
Land Rover Freelander 2006 - 1996

UNIT PACKAGE: 15



### MAZDA CLIPS & FASTENERS



**22519**

(Mazda: C274-50-133)  
Gray Nylon

Front Bumper Retainer Nut  
Screw Size: M4.8 (#10)  
Center of Hole to Edge: 11mm  
Panel Range: Up to 1mm  
Mazda 2, 5, 6, CX-5, CX-7 &  
CX-9 2014 - 2010

UNIT PACKAGE: 25



**22517**

(Mazda: G46L-50-EB1)  
Black Nylon

Grille Emblem Clip  
Head Size: 9mm x 22mm  
Stem Width: 9mm  
Stem Length: 13mm  
Mazda 3, CX-3, CX-5  
& CX-9 2016 - On

UNIT PACKAGE: 25



**22516**

(Mazda: D001-56-731)  
Black Nylon

Hood Release Cable Clip  
Holds 5mm Diameter Cable  
Stem Length: 9mm  
Fits into 6mm Hole  
Mazda 2, 3, 5, 6, 323, 626, CX-5, CX-7,  
CX-9, Miata, Millenia, MPV, MX-3, MX-6,  
Protégé, RX-7 & RX-8 2013 - 1989

UNIT PACKAGE: 25

### MAZDA CLIPS & FASTENERS



**22483**

(Mazda: S47P-64-345;  
Mitsubishi: MQ907568)  
White Nylon

Instrument & Side Panel Clip  
Width (Ear to Ear): 10.3mm  
Overall Height: 18.6mm  
Mazda 2, 3, 5, 6, CX-5, CX-7, CX-9,  
Miata, MPV, Protégé & RX-8  
and Mitsubishi 2000 - On

UNIT PACKAGE: 25



**22520**

(Mazda: KD53-51-SJ3A)  
Gray Nylon

Stone Guard  
Moulding Clip with Sealer  
Top Head Size: 10mm x 15mm  
Bottom Head Diameter: 18mm  
Stem Diameter: 12mm  
Stem Length: 9mm  
Mazda CX-5 2016 - On

UNIT PACKAGE: 25

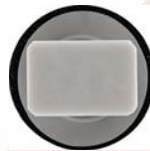

**22512**

(Mazda: KD53-51-W24)  
Gray Nylon

Wheel Arch Moulding Retainer  
Top Head Diameter: 14mm  
Bottom Head Diameter: 18.5mm  
Stem Diameter: 11mm  
Stem Length: 14mm  
Mazda CX-3, CX-5  
& CX-9 2013 - On

UNIT PACKAGE: 25



**22510**

(Mazda: KD51-51-W24)  
White Nylon

Wheel Opening Moulding  
Retainer with Sealer  
Top Head Diameter: 15mm  
Bottom Head Diameter: 18.5mm  
Stem Diameter: 10.8mm  
Stem Length: 14mm  
Mazda CX-5 2014 - 2013

UNIT PACKAGE: 15





**New**

# MAZDA, MERCEDES-BENZ AND MITSUBISHI CLIPS & FASTENERS

## MAZDA CLIPS & FASTENERS



**22511**

(Mazda: D10E-51-SJ3)  
Green Nylon

Rocker Panel Moulding Retainer with Sealer  
Top Head Size: 13mm x 17mm  
Bottom Head Diameter: 18.5mm  
Stem Diameter: 11.7mm  
Stem Length: 12mm  
Mazda 3, 5, CX-3, CX-9, Miata & MX-5 2016 - On

UNIT PACKAGE: 15



**22484**

(Mazda & Ford: E120-68-AB1;  
Mitsubishi: MR975267)  
Yellow Nylon

Pillar, Scuff Plate & Trim Panel Retainer  
Top Head Diameter: 13mm  
Middle Head Diameter: 16.5mm  
Bottom Head Diameter: 18mm  
Stem Diameter: 9.3mm  
Stem Length: 13mm  
Overall Length: 20mm  
Mazda 2 & 3 2015 - 2013  
Mitsubishi Montero 1999 - On  
Ford Escape (European Version) 2006 - 2000

UNIT PACKAGE: 25



**22424**

(Mazda: B45A-56-146A;  
Toyota: 90118-WB048)  
Black Nylon

Bumper, Engine Cover, Fender & Quarter Panel Push-Type Retainer  
Head Diameter: 20mm  
Stem Length: 13mm  
Fits into 8mm Hole  
Mazda 3, 5, 6, CX-3, CX-5, CX-9 & MX-5 Miata 2012 - On  
Scion iA 2016 - On

UNIT PACKAGE: 25



**22515**

(Mazda: BGV4-56-145)  
Black Nylon

Bumper Cover & Fender Liner Push-Type Retainer  
Head Diameter: 20mm  
Stem Length: 14mm  
Fits into 8mm Hole  
Mazda 2, 3, 6, CX-9 & Miata 2010 - On

UNIT PACKAGE: 25

## MERCEDES-BENZ CLIP & FASTENERS



**22504**

(Mercedes: 009-988-03-78)  
White Nylon

Lower Weatherstrip Retaining Clip  
Top Head Size: 12mm x 15mm  
Grommet Head Diameter: 11.3mm  
Grommet Stem Length: 13mm  
Overall Length: 21mm  
Mercedes-Benz SLK 230 & SLK 320 2004 - 2001

UNIT PACKAGE: 25



**21872**

(VW: 6E0-837-732)  
Turquoise Nylon

Trim Panel Retainer with Sealer  
Top Head Diameter: 13mm  
Middle Head Diameter: 13mm  
Bottom Head Diameter: 18mm  
Stem Diameter: 9mm  
Stem Length: 12mm  
Renault, Dacia, Mercedes, VW, Audi, SEAT & Skoda

UNIT PACKAGE: 25



**22498**

(Mercedes: 008-988-09-78)  
Gray Nylon

Headliner Retainer  
Top Head Diameter: 13.5mm  
Middle Head Diameter: 13.5mm  
Bottom Head Diameter: 20mm  
Stem Diameter: 9.5mm  
Stem Length: 13mm  
Mercedes-Benz Metris & Sprinter 2010 - On

UNIT PACKAGE: 15

## MITSUBISHI CLIPS & FASTENERS



**22483**

(Mazda: S47P-64-345;  
Mitsubishi: MQ907568)  
White Nylon

Instrument & Side Panel Clip  
Width (Ear to Ear): 10.3mm  
Overall Height: 18.6mm  
Mazda 2, 3, 5, 6, CX-5, CX-7, CX-9, Miata, MPV, Protégé & RX-8 and Mitsubishi 2000 - On

UNIT PACKAGE: 25

**New**

## MITSUBISHI, NISSAN AND INFINITI CLIPS & FASTENERS



**22361**

(Mitsubishi: MR489986)  
Pale Yellow Nylon

Wheel Arch Cover Retainer with Sealer  
Top Head Diameter: 12mm  
Bottom Head Diameter: 16mm  
Stem Diameter: 8mm  
Stem Length: 8mm  
Mitsubishi Montero 2001 - On  
Outlander 2015 - On

UNIT PACKAGE: 15



**22462**

(Mitsubishi: MU000977)  
Blue Nylon

Rocker Moulding Retainer  
Top Head Diameter: 13mm  
Bottom Head Diameter: 18mm  
Stem Diameter: 9.8mm  
Stem Length: 9mm  
Mitsubishi Mirage 2014 - On

UNIT PACKAGE: 25



**22513**

(Mitsubishi: MU000573)  
White Nylon

Interior Speaker Grille &  
Rocker Moulding Retainer  
Top Head Diameter: 12mm  
Bottom Head Diameter: 16mm  
Stem Diameter: 8mm  
Stem Length: 10mm  
Mitsubishi Galant 2012 - On  
Lancer 2016 - 2008

UNIT PACKAGE: 25



**22484**

(Mazda & Ford: E120-68-AB1;  
Mitsubishi: MR975267)  
Yellow Nylon

Pillar, Scuff Plate & Trim Panel Retainer  
Top Head Diameter: 13mm  
Middle Head Diameter: 16.5mm  
Bottom Head Diameter: 18mm  
Stem Diameter: 9.3mm  
Stem Length: 13mm  
Overall Length: 20mm  
Mazda 2 & 3 2015 - 2013  
Mitsubishi Montero 1999 - On  
Ford Escape (European Version)  
2006 - 2000

UNIT PACKAGE: 25

## NISSAN AND INFINITI CLIPS & FASTENERS



**22522**

(Nissan: 85099-1MA0A)  
Yellow Nylon

Front & Rear Bumper  
Screw Grommet  
Screw Size: M5.5 (#12)  
Top Head Size: 10mm x 10mm  
Bottom Head Size: 15mm x 16mm  
Stem Length: 9mm  
Nissan Pathfinder, Sentra,  
Versa & Versa Note 2012 - On

UNIT PACKAGE: 25



**22416**

(Nissan: 01281-00111)  
Natural Nylon

Screw Grommet  
Screw Size: M5.5 (#12)  
Head Diameter: 16mm  
Stem Length: 11mm  
Infiniti FX35, FX45, G20, G25, G35, G37, I30,  
J30, Q40, Q45, Q60, QX4 & QX56 1997 - On  
Nissan 200SX, 240SX, 300ZX, Altima, Armada, Cube,  
Frontier, GT-R, Juke, Leaf, Maxima, Murano, Pathfinder,  
Quest, Rogue & Sentra 1987 - On

UNIT PACKAGE: 25



**22494**

(Nissan: 01281-01431)  
Natural Nylon

Front Bumper Screw Grommet  
Screw Size: M5.5 (#12)  
Head Diameter: 14mm  
Stem Length: 17mm  
Overall Length: 20mm  
Infiniti Q30 2017 - On  
Nissan Altima, Cube, Maxima,  
Murano, NV, Quest, Sentra,  
Titan & Versa 2009 - On

UNIT PACKAGE: 25



**22440**

(Nissan: 26557-2U000)  
Gray Nylon

Quarter Panel, Rear Light &  
Spoiler Grommet with Sealer  
Screw Size: M6.3-1.81 (#14)  
Head Size: 15mm x 19mm  
Stem Length: 16mm  
Overall Length: 17.5mm  
Infiniti FX35, FX50, G37, JX35, M35, M45, Q50, Q60,  
QX50, QX60, QX70 & QX80 and Nissan 350Z, Altima,  
Armada, Maxima, Murano, Pathfinder, Quest,  
Rogue, Sentra & Versa 2003 - On

UNIT PACKAGE: 25



**New**

## NISSAN, INFINITI AND SUBARU CLIPS & FASTENERS



### 22523

(Nissan: 76882-1KA1A)  
Green Nylon

Rocker Panel  
Moulding Clip with Sealer  
Top Head Size: 10mm x 17mm  
Bottom Head Diameter: 18mm  
Stem Length: 12mm  
Fits into 8mm Hole  
Nissan Juke 2016 - On

UNIT PACKAGE: 25



### 22503

(Nissan: 01553-0170U)  
Black Nylon

Front Bumper Cover Retainer  
Head Diameter: 18mm  
Stem Diameter: 8.5mm  
Stem Length: 19mm  
Nissan Altima 2015 - On

UNIT PACKAGE: 25



### 22452

(Nissan: 85284-AL510)  
Gray Nylon

Rear Bumper Cover  
Moulding Clip  
Width: 20mm  
Length: 32mm  
Overall Height: 20.5mm  
Infiniti G35, FX35 &  
FX45 2008 - 2003  
Nissan Pathfinder 2012 - 2005

UNIT PACKAGE: 5



### 22368

(Nissan: 84937-6P000)  
Black Nylon

Trunk Knit Hook  
Push-Type Retainer  
Top Head Diameter: 24mm  
Bottom Head Diameter: 27mm  
Stem Length: 10mm  
Overall Length: 25mm  
Fits into 8mm Hole  
Infiniti Q45 2000 - 1997  
Nissan 350Z, Altima & GT-R  
2003 - On

UNIT PACKAGE: 15



### 22476

(Nissan: 66820-4BA5A)  
Black Nylon

Cowl Grille Clip  
Width: 13mm x 20mm  
Overall Height: 20mm  
Nissan Rogue 2014 - On

UNIT PACKAGE: 25

## SUBARU CLIPS & FASTENERS



### 22429

(Subaru: 99045SG000)  
Green Nylon

Front Fender  
Moulding Clip with Sealer  
Top Head Size: 8mm x 12mm  
Bottom Head Diameter: 14mm  
Stem Diameter: 11.3mm  
Stem Length: 16mm  
Subaru Forester 2014 - On

UNIT PACKAGE: 15



### 22364

(Subaru: 94044TA040)  
Gray Nylon

Door Panel Retainer  
Top Head Diameter: 13mm  
Middle Head Diameter: 16mm  
Bottom Head Diameter: 18mm  
Stem Diameter: 9mm  
Stem Length: 13mm  
Overall Length: 20mm  
Subaru Impreza, Legacy,  
Outback & STI 2016 - 2007

UNIT PACKAGE: 25

**New**

# TOYOTA AND LEXUS CLIPS & FASTENERS



**22490**

(Toyota: 90541-09124)  
Rubber & Nylon

Rear Door Rubber Bumper  
Rubber Diameter Top: 14mm  
Rubber Diameter Bottom: 17mm  
Overall Height: 16.5mm  
Lexus CT 200h, HS 250h, IS 250 & IS 350  
and Toyota Avalon, Camry, C-HR,  
Corolla, Highlander Matrix, Prius,  
Prius Prime & Yaris 2009 - On  
Scion iQ & tC 2016 - 2009

UNIT PACKAGE: 25



**22413**

(Toyota: 90541-09069)  
Rubber & Nylon

Front Door Rubber Bumper  
Rubber Diameter Top: 15mm  
Rubber Diameter Bottom: 17mm  
Overall Height: 19.5mm  
Toyota 4Runner, Corolla, Highlander,  
Land Cruiser, Matrix, RAV4 &  
Terrel 1999 - On

UNIT PACKAGE: 25



**22488**

(Toyota: 81496-52020, 81496-0E020)  
Natural Nylon

Rear Combination Tail Light  
Guide Grommet with Sealer  
Head Diameter: 16mm  
Stem Length: 14mm  
Overall Length: 15mm  
Lexus CT 200h, ES 300h, ES 350, GX 460,  
IS 200t, IS 250, IS 300, IS 350, LC 500h,  
LX 570, NX 200t, NX 300h, RC F, RC 200h,  
RC 300, RC 350, RX 350 & RX 450h  
and Toyota 4Runner, C-HR, Corolla,  
Corolla iM, Highlander, Land Cruiser,  
Mirai, Prius, Prius Prime, Prius V, RAV4,  
Sequoia, Venza & Yaris 2006 - On  
Scion iM & xD 2016 - 2008

UNIT PACKAGE: 25



**22525**

(Toyota: 75494-42010,  
75395-42020)  
Yellow Nylon

Rocker Moulding Clip with Sealer  
Top Head Size: 10.3mm x 16.5mm  
Bottom Head Size: 13.5mm x 17.5mm  
Stem Length: 19mm  
Toyota FJ Cruiser &  
RAV4 2014 - 2001

UNIT PACKAGE: 25



**22456**

(Toyota: 62955-50010)  
Yellow Nylon

Rocker & Quarter Vent  
Moulding Clip with Sealer  
Top Head Size: 8mm x 8mm  
Bottom Head Diameter: 15mm  
Stem Diameter: 8mm x 8mm  
Stem Length: 11mm  
Lexus ES 250, HS 250h, LS 460, LS  
600h L, RX 350 & RX 450h and Toyota  
Highlander, RAV4 & Yaris 2013 - On

UNIT PACKAGE: 25



**22396**

(Lexus: 90467-08224)  
White Nylon

Body Side & Wheel Opening  
Moulding Clip  
Top Head Size: 10mm x 10.5mm  
Bottom Head Diameter: 15mm  
Stem Diameter: 8mm x 8mm  
Stem Length: 8mm  
Lexus NX 200t, NX 300h, RX 350  
& RX 450h 2015 - On

UNIT PACKAGE: 25



**22398**

(Toyota: 81496-60010)  
White Nylon

Rear Combination Lamp Guide  
Moulding Clip with Sealer  
Top Head Diameter: 13mm  
Bottom Head Diameter: 20mm  
Stem Length: 10.5mm  
Lexus CT 200h, ES 300h, ES 350,  
GX 470, IS F, IS 250, NX 200t, NX 300h,  
RC F, RC 350, RX 330, RX 350, RX 400h  
& RX 450h and Toyota 4Runner, Avalon, Camry,  
Camry Hybrid, Corolla, Matrix, Prius, Prius C, RAV4,  
Sienna, Venza & Yaris 2006 - On  
Scion iQ & iQ EV 2014 - 2011

UNIT PACKAGE: 25



**22427**

(Toyota: 75548-60021)  
White Nylon

Rocker, Pillar, Exterior Trim &  
Windshield Moulding Clip  
Width: 15.5mm  
Length: 52mm  
Lexus LX 570 & Toyota Land Cruiser 2008 - On

UNIT PACKAGE: 10

# TOYOTA AND LEXUS CLIPS & FASTENERS

**New**



## 22472

(Toyota: 90467-06005)  
Black Nylon

Hood Release Cable Clamp Clip  
Head Size: 16mm x 21mm  
Holds 5mm Diameter Rod  
Stem Diameter: 12mm  
Stem Length: 9mm  
Lexus CT 200h, GX 470, HS 250h,  
LX 570, NX 200t, NX 300h, RX 350  
& RX 450h 2003 - On  
Toyota 4Runner, Avalon, Camry, Celica,  
C-HR, Corolla, Land Cruiser, Matrix, Mirai,  
Prius, RAV4, Tacoma & Yaris 1994 - On

UNIT PACKAGE: 25



## 22497

(Toyota: 65487-60010)  
Black Nylon

Hood Seal Retaining Clip  
Head Size: 5mm x 13mm  
Stem Diameter: 7mm  
Stem Length: 8mm  
Lexus CT 200h, ES 300h, ES 350, GS F, GS 200t,  
GS 350, GS 450h, LC 500h & LX 570 and  
Toyota Land Cruiser & Mirai 2008 - On

UNIT PACKAGE: 25



## 22487

(Toyota: 90467-06192)  
Black Nylon

Fender Liner Retaining Clip  
Head Size: 14.5mm x 16mm  
Stem Diameter: 10.5mm  
Stem Length: 10mm  
Fits into 8mm Hole  
Lexus ES 300h; ES 350; GS 200h;  
GS 350; GS F, GS 450h; IS 200t; IS 300,  
IS 350, LS 460, LS 600h L & RC F and  
Toyota Camry & RAV4 2006 - On

UNIT PACKAGE: 25

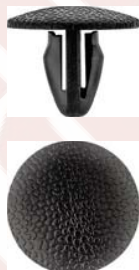

## 22395

(Toyota: 90467-09169-C0)  
Black Nylon

Lower Fender Shield & Front Floor  
Carpet Shield Retaining Clip  
Head Diameter: 18mm  
Stem Length: 12mm  
Fits into 7mm Hole  
Lexus GX 470, RX 330  
& RX 400h 2009 - 2003  
Toyota 4Runner, MR2 Spyder  
Paseo & Tercel 2009 - 1995

UNIT PACKAGE: 15



## 22495

(Toyota: 90467-06205-C0)  
Black Nylon

Front Fender Retaining Clip with Sealer  
Head Diameter: 20mm  
Stem Diameter: 8mm  
Stem Length: 9mm  
Lexus GS F, GS 350, GS 450h,  
GX 460, HS 250h, IS 200t, IS 250, IS 300,  
IS 350, LC 500h, RC F, RC 200t, RC 300,  
RC350, RX 350 & RX 450h 2010 - On  
Scion iQ & xD and Toyota 4Runner  
& Highlander 2015 - 2008

UNIT PACKAGE: 25



## 22454

(Toyota: 76817-68010)  
Yellow Nylon

Door Garnish Clip with Sealer  
Top Head Size: 10mm x 10mm  
Bottom Head Diameter: 16mm  
Stem Diameter: 9.5mm x 9.5mm  
Stem Length: 15mm  
Lexus LX 570 and Toyota  
Land Cruiser & RAV4 2013 - On

UNIT PACKAGE: 25



## 22412

(Toyota: 53879-0R010;  
53879-28010)  
Black Nylon

Front Fender Liner Clip  
Slotted Head Dia.: 15.3mm  
Body Width: 35mm  
Toyota Highlander,  
RAV4 & Tacoma and  
Scion iQ & xD 2008 - On

UNIT PACKAGE: 25



## 22489

(Toyota: 53879-30050)  
Black Nylon

Fender Liner Retaining Clip  
Width: 42mm  
Length: 29.5mm  
Lexus GS F, GS 200t,  
GS 350, GS 450h, IS 200t,  
IS 250, IS 300, IS 350,  
RC F, RC 200t, RC 300 &  
RC 350 2013 - On  
Toyota C-HR, Prius, Prius  
Prime & Prius V 2016 - On

UNIT PACKAGE: 15



**New**

# TOYOTA AND LEXUS CLIPS & FASTENERS



**22457**

(Toyota: 76924-13020)  
Black Nylon

Rocker Moulding Retainer  
Head Diameter: 25mm  
Stem Length: 11mm  
Fits into 14mm Hole  
Toyota 4Runner &  
Land Cruiser 2008 - On

UNIT PACKAGE: 25



**22369**

(Toyota: 90467-08188)  
Black Nylon

Luggage Compartment Trim Retainer  
Head Diameter: 16mm  
Stem Diameter: 8mm  
Stem Length: 12mm  
Lexus ES 300, LS 430 &  
SC 430 2010 - 1996  
Toyota Prius & Sienna 2003 - 1998  
Scion iQ 2015 - 2012

UNIT PACKAGE: 25



**22473**

(Toyota: 90467-A0002-C0)  
Black Nylon

Trunk Side Trim Retainer  
Head Diameter: 16mm  
Stem Diameter: 8mm  
Stem Length: 16mm  
Lexus RX 330, RX 350 &  
RX 450h 2011 - 2004  
Toyota Matrix, Sienna &  
Venza 2014 - 2009

UNIT PACKAGE: 25



**22455**

(Toyota: 90467-A0032)  
White Nylon

Lower Door Moulding  
Retainer with Sealer  
Top Head Diameter: 10mm  
Bottom Head Diameter: 15mm  
Stem Diameter: 8.3mm x 8.3mm  
Stem Length: 10mm  
Toyota RAV4 2014 - On

UNIT PACKAGE: 25



**22478**

(Toyota: 75867-52020)  
Blue Nylon

Rocker Panel Retainer  
Top Head Diameter: 13mm  
Bottom Head Diameter: 18mm  
Stem Diameter: 9.5mm  
Stem Length: 13mm  
Overall Length: 19mm  
Toyota Prius, Prius C, Prius Prime  
& Yaris 2012 - On

UNIT PACKAGE: 25



**22471**

(Toyota: 90467-A0007)  
White Nylon

Scuff Plate Retainer  
Top Head Diameter: 13mm  
Bottom Head Diameter: 18mm  
Stem Diameter: 9.3mm  
Stem Length: 11mm  
Lexus RX 330, RX 350 and RX 450h  
and Toyota Avalon, Camry, Matrix,  
Sequoia, Sienna & Tundra 2004 - On

UNIT PACKAGE: 25



**22486**

(Toyota: 67771-26240)  
Blue Nylon

Door Trim Retainer with Sealer  
Top Head Diameter: 13mm  
Middle Head Diameter: 16mm  
Bottom Head Diameter: 18mm  
Stem Diameter: 9.6mm  
Stem Length: 10mm  
Overall Length: 16.5mm  
Lexus CT 200h, ES 300h, ES 350, GS  
200t, GS 350, IS 200t, IS 250, IS 300, LC  
500h, LS 460, NX 200t, NX 300h, RC 200t,  
RC 300, RC 350, RX 350 & RX 450h  
and Toyota FJ Cruiser, Prius C  
& Prius V 2006 - On

UNIT PACKAGE: 25



**22460**

(Toyota: 62489-0E010)  
White Nylon

Door Sill, Headliner, Liftgate Trim Cover,  
Pillars, Scuff Plate & Window Trim Retainer  
Top Head Diameter: 13mm  
Middle Head Diameter: 16mm  
Bottom Head Diameter: 18mm  
Stem Diameter: 11mm  
Stem Length: 14mm  
Overall Length: 20mm  
Lexus RX 350 & RX 450h 2015 - 2010  
Toyota Avalon, Corolla, Highlander,  
RAV4, Sienna & Venza 2013 - On

UNIT PACKAGE: 25



**22479**

(Lexus: 51787-60070)  
White Nylon

Door Scuff Plate Retainer  
Top Head Size: 12mm x 17mm  
Middle Head Diameter: 15mm  
Bottom Head Diameter: 18mm  
Stem Diameter: 8.5mm  
Stem Length: 9mm  
Lexus GX 460 & LX 570 2003 - On

UNIT PACKAGE: 25



# TOYOTA AND LEXUS CLIPS & FASTENERS

**New**



### 22400

(Toyota: 90467-07217)  
Black Nylon

Radiator Support Access Cover,  
Air Deflector & Side Shield  
Push-Type Retainer  
Head Diameter: 19mm  
Stem Length: 9mm  
Fits into 7mm Hole  
Lexus LX, IS, GS, RX 350 &  
RX 450h and Toyota Camry, Corolla,  
Land Cruiser Prius, RAV4  
& Yaris 2010 - On

UNIT PACKAGE: 25



### 22439

(Toyota: 90467-07215)  
Black Nylon

Fender Liner Push-Type Retainer  
Head Diameter: 20mm  
Stem Length: 10mm  
Fits into 7mm Hole  
Scion tC and Toyota 4Runner,  
Avalon, Camry, Corolla,  
Highlander, Land Cruiser, Prius,  
RAV4, Tacoma & Tundra 2010 - On

UNIT PACKAGE: 25



### 22424

(Mazda: B45A-56-146A;  
Toyota: 90118-WB048)  
Black Nylon

Bumper, Engine Cover, Fender &  
Quarter Panel Push-Type Retainer  
Head Diameter: 20mm  
Stem Length: 13mm  
Fits into 8mm Hole  
Mazda 3, 5, 6, CX-3, CX-5, CX-9 &  
MX-5 Miata 2012 - On  
Scion iA 2016 - On

UNIT PACKAGE: 25



### 22502

(Toyota: 76923-52021)  
Black Nylon

Side Mud Guard  
Push-Type Retainer  
Head Diameter: 29mm  
Stem Length: 10mm  
Fits into 22mm Hole  
Lexus GS F, GS 200t, GS 350,  
GS 450h, IS 200t, IS 250, IS 300,  
IS 350, RC F, RC 200t, RC 300  
& RC 350 2013 - On  
Toyota Yaris 2011 - 2007  
Scion xD 2014 - 2008

UNIT PACKAGE: 15

## GET AUVECO'S NEWEST ITEMS AS SOON AS THEY ARE RELEASED!



## NEW ITEMS BULLETINS

Auveco releases a set of our Hot New Items every other week.

To receive these bulletins please contact customer service:

mail@auveco.com or 1-800-354-9816

We also have all previous and current bulletins posted on [www.auveco.com](http://www.auveco.com).

**New**

## VOLKSWAGEN AND AUDI CLIPS & FASTENERS

(Includes SEAT & Skoda)



**21933**

(VW: 8D0-807-192)  
Green Nylon

Nylon U-Nut  
Screw Size: M4.8 (#10)  
Panel Range: Up to 3mm  
Center of Hole to Edge: 11mm  
Overall Height: 16mm  
Renault, Dacia, VW, Audi, SEAT & Skoda

UNIT PACKAGE: 10



**22418**

(VW: N90-757-901, N903-521-01)  
Black Nylon



Fender Liner Nylon Nut  
Screw Size: M4.8 (#10)  
Hex Size: 10mm  
Flange Diameter: 22mm  
Overall Height: 11mm  
Audi A7, A8, Q3, RS7, S7 & S8 and  
Volkswagen Beetle, Golf, GTI, Passat,  
Tiguan & Touareg 2010 - On

UNIT PACKAGE: 25



**22414**

(VW: 8R0-853-909)  
White Nylon



Door Moulding Clip with  
Blue Rubber Grommet  
Top Head Size: 12mm x 12mm  
Stem Length: 13mm  
Overall Length: 18.5mm  
Audi Q3, Q3 Quattro & Q5 and  
Volkswagen 2009 - On

UNIT PACKAGE: 25



**22445**

(VW: 3C0-853-586)  
Black Nylon



Wheel Well Opening Grommet  
Head Diameter: 16mm  
Stem Length: 15mm  
Overall Length: 16.5mm  
Audi Q5 & RS5 2015 - 2009  
Volkswagen Beetle, Passat,  
Tiguan & Touareg 2006 - On

UNIT PACKAGE: 25



**22426**

(Audi: 8T0-853-909-A)  
Black Nylon

Rocker Moulding Clip  
Width: 16mm  
Length: 40mm  
Audi A4, A4 allroad,  
A5, S4 & S5 2008 - On

UNIT PACKAGE: 15



**22442**

(Audi: 8V0-868-243)  
Black Nylon



Door Trim Panel Retaining Clip  
Size: 25mm x 26mm  
Overall Height: 12.5mm  
Audi A3, S3, Q7 & TT 2015 - On

UNIT PACKAGE: 25



**22411**

(VW: 3D0-864-851-B41)  
Black Nylon



Floor Mat Retaining Clip  
Top Head Size: 12mm x 20mm  
Bottom Head Diameter: 35mm  
Stem Length: 14mm  
Volkswagen Golf, R32,  
GTI, Rabbit, Jetta &  
Passat 2016 - 2005

UNIT PACKAGE: 25



**22441**

(VW: 3D0-864-812-A-B41)  
Black Nylon



Floor Mat Stay Retainer  
Head Diameter: 30mm  
Stem Diameter: 9mm  
Stem Length: 14mm  
Overall Length: 24.5mm  
Audi & Volkswagen Beetle,  
Golf & Passat 2007 - 1999

UNIT PACKAGE: 25



**22447**

(VW: 6Q0-853-147)  
Black Nylon



Carpet, Door Sill Plate, Floor Mat,  
Quarter Panel Trim, Scuff Plate &  
Wheel House Retainer  
Top Head Size: 12mm x 14mm  
Overall Length: 21mm  
Audi A3 & A4 2013 - 2005  
Volkswagen Golf Alltrack, Golf, Jetta,  
Passat & Rabbit 2005 - On

UNIT PACKAGE: 25



# VOLKSWAGEN AND AUDI CLIPS & FASTENERS

(Includes SEAT & Skoda)

**New**



## 22399

(VW: 6Q0-807-643)  
Black Nylon

Rear Bumper Trim Pin Retainer  
Head Diameter: 17.5mm  
Stem Length: 25mm  
Overall Length: 34.3mm  
Audi A1, A3, Q5, Q7 & TT and  
Volkswagen CC, Eos, Golf,  
Jetta, Passat, Polo, Tiguan,  
Touran & Transporter 2004 - On

UNIT PACKAGE: 25



## 22449

(VW: N90-911-301)  
Black Nylon

Interior Trim Panel &  
Cowl Cover Retainer  
Head Diameter: 20mm  
Stem Diameter: 8mm  
Stem Length: 16mm  
Audi A3 & S3 2015 - On  
Volkswagen Golf, Jetta &  
Passat 2012 - On

UNIT PACKAGE: 25



## 22417

(Audi: 8U0-853-909)  
Blue Nylon

Wheel Arch Opening  
Moulding Retainer with Sealer  
Top Head Diameter: 13.3mm  
Bottom Head Diameter: 17mm  
Stem Diameter: 9.3mm  
Stem Length: 10mm  
Audi RS & Q3 and Volkswagen Golf,  
R32, GTI & Rabbit, 2015 - On

UNIT PACKAGE: 25



## 21872

(VW: 6E0-837-732)  
Turquoise Nylon

Trim Panel Retainer with Sealer  
Top Head Diameter: 13mm  
Middle Head Diameter: 13mm  
Bottom Head Diameter: 18mm  
Stem Diameter: 9mm  
Stem Length: 12mm  
Renault, Dacia, Mercedes, VW,  
Audi, SEAT & Skoda

UNIT PACKAGE: 25



## 22397

(VW: 1K0-837-199B; 8L3837199B;  
811807447; 8L4833052;  
8L4833051 8L837199)  
Black Nylon

Front Door Push-Type Retainer  
Top Head Diameter: 10mm  
Bottom Head Size: 10mm x 22mm  
Stem Length: 12mm  
Fits into 7mm Hole  
Audi A3, A4, A6, A7, A8, RS 4,  
RS 6 & TT and Volkswagen Golf &  
Jetta 2011 - 1996

UNIT PACKAGE: 15



## 22421

(VW: N10-700-901)  
Black Nylon

Front Suspension Shield  
Push-Type Retainer  
Head Diameter: 15mm  
Stem Length: 11mm  
Fits into 5mm Hole  
Audi A3 & Q7 and Porsche 911 &  
Cayenne and Volkswagen Golf, Jetta,  
Passat, Eos & Phaeton 2009 - On

UNIT PACKAGE: 25



## 22420

(Audi: 8K0-868-307)  
Black Nylon

Fender End Plate  
Push-Type Retainer  
Head Diameter: 16mm  
Stem Length: 12mm  
Fits into 10.5mm Hole  
Audi A4 allroad, A5, A7, Q7, RS5,  
RS7, S5 & S7 2009 - On

UNIT PACKAGE: 25



## 22444

(VW: 8E0-864-229-9B9)  
Black Nylon

Carpet Retaining Cap  
Diameter: 30mm  
Height: 15mm  
Audi & Volkswagen Tiguan  
2012 - On

UNIT PACKAGE: 25

**New**

# RENAULT AND DACIA

## Clips & Fasteners for Vehicles with European Applications



**22002**

(Renault & Dacia: 77-03-088-105)  
Black Rubber

Rubber Bumper  
Head Diameter: 15mm  
Fits into 6mm Hole  
Renault & Dacia

UNIT PACKAGE: 15



**21901**

Black Nylon

Trim Panel Retainer  
Head Diameter: 14.5mm  
Stem Diameter: 7.5mm  
Stem Length: 13mm  
Renault & Dacia

UNIT PACKAGE: 25



**21928**

(Renault & Dacia: 77-01-397-183)  
White Nylon

Nylon Nut  
Screw Size: M4.2 (#8)  
Head Size: 9.5mm x 9.5mm  
Stem Length: 7mm  
Peugeot, Citroen,  
Renault & Dacia

UNIT PACKAGE: 50



**21904**

(Renault & Dacia: 80-00-609-205)  
Tan Nylon

Trim Panel Retainer  
Head Diameter: 21mm  
Stem Diameter: 7.5mm  
Stem Length: 19mm  
Renault & Dacia

UNIT PACKAGE: 25



**21933**

(VW: 8D0-807-192)  
Green Nylon

Nylon U-Nut  
Screw Size: M4.8 (#10)  
Panel Range: Up to 3mm  
Center of Hole to Edge: 11mm  
Overall Height: 16mm  
Renault, Dacia, VW, Audi, SEAT & Skoda

UNIT PACKAGE: 10



**21903**

(Renault & Dacia: 82-00-939-873)  
Black Nylon

Trim Panel Retainer  
Head Diameter: 21mm  
Stem Diameter: 7.5mm  
Stem Length: 19mm  
Renault & Dacia

UNIT PACKAGE: 25



**21866**

(Renault & Dacia: 77-03-077-421)  
Red Nylon

Moulding Clip  
Head Diameter: 19mm  
Stem Diameter: 9mm  
Stem Length: 8mm  
Overall Length: 17mm  
Renault & Dacia

UNIT PACKAGE: 25



**21869**

(Renault & Dacia: 77-03-077-117)  
Black Nylon

Trim Panel Retainer  
Head Diameter: 20.5mm  
Stem Diameter: 7mm  
Stem Length: 14mm  
Renault & Dacia

UNIT PACKAGE: 25



**21867**

(Renault & Dacia: 77-03-077-422)  
Gray Nylon

Moulding Clip  
Head Diameter: 19mm  
Stem Diameter: 9mm  
Stem Length: 8mm  
Overall Length: 17mm  
Renault & Dacia

UNIT PACKAGE: 25



**21899**

(Renault & Dacia: 77-03-077-444)  
Black Nylon

Trim Panel Retainer  
Head Diameter: 20mm  
Stem Diameter 7mm  
Stem Length: 16mm  
Renault & Dacia

UNIT PACKAGE: 25

# RENAULT, DACIA, PEUGEOT AND CITROEN

**New**

## Clips & Fasteners for Vehicles with European Applications



**21902**

(Renault & Dacia: 82-00-151-367)  
Gray Nylon

Trim Panel Retainer  
Head Diameter: 20mm  
Stem Diameter: 7.5mm  
Stem Length: 14mm  
Renault & Dacia

UNIT PACKAGE: 25



**21872**

(VW: 6E0-837-732)  
Turquoise Nylon

Trim Panel Retainer with Sealer  
Top Head Diameter: 13mm  
Middle Head Diameter: 13mm  
Bottom Head Diameter: 18mm  
Stem Diameter: 9mm  
Stem Length: 12mm

Renault, Dacia, Mercedes, VW, Audi, SEAT & Skoda

UNIT PACKAGE: 25



**21925**

Blue Nylon

Door Lock Rod Clip  
Rod Size: 3mm  
Peugeot, Citroen, Renault & Dacia

UNIT PACKAGE: 15

## PEUGEOT AND CITROEN



**21955**

(Peugeot & Citroen: 6992.G2)  
Natural Nylon

Nylon Nut  
Screw Size: M2.9 (#4)  
Head Diameter: 13mm  
Stem Length: 8mm  
Peugeot & Citroen

UNIT PACKAGE: 50



**21957**

(Peugeot & Citroen: 6991.G1)  
White Nylon

Nylon Nut with Sealer  
Screw Size: M4.2 (#8)  
Head Size: 9.5mm x 9.5mm  
Stem Length: 11mm  
Peugeot & Citroen

UNIT PACKAGE: 10



**21956**

(Peugeot & Citroen: 9227.35)  
Natural Nylon

Nylon Nut  
Screw Size: M3.5 (#6)  
Head Diameter: 10mm  
Stem Length: 6mm  
Peugeot & Citroen

UNIT PACKAGE: 25



**21948**

(Peugeot & Citroen: 6984.03)  
Zinc Plated

Cage Screw  
M6-1.0 x 20mm  
Overall Length: 24mm  
Peugeot & Citroen

UNIT PACKAGE: 10



**21928**

(Renault & Dacia: 77-01-397-183)  
White Nylon

Nylon Nut  
Screw Size: M4.2 (#8)  
Head Size: 9.5mm x 9.5mm  
Stem Length: 7mm  
Peugeot, Citroen, Renault & Dacia

UNIT PACKAGE: 50



**21945**

(Peugeot & Citroen: 7030.16,  
7030.18, 7030.17)

Cowl Fastener Set  
Slotted Head Diameter: 16mm  
Stem Length: 20mm  
Cowl Nut Width: 23mm  
Cowl Nut Height: 10mm  
Nylon Washer Outside Diameter: 17mm  
Zinc Plated Steel Fastener & Nut  
Peugeot & Citroen

UNIT PACKAGE: 5 Sets



New

# PEUGEOT & CITROEN AND HAND SANDING PADS

## Clips & Fasteners for Vehicles with European Applications



**21946**

Cowl Fastener Set  
Zinc Plated Steel Fastener  
Slotted Head Diameter: 16mm  
Stem Length: 21mm  
Cowl Nut Width: 23mm  
Cowl Nut Height: 14mm

UNIT PACKAGE: 5 Sets



**21952**

Natural Nylon

Door Lock Rod Clip  
Used on Left-Hand Side  
Rod Size: 3mm  
Peugeot & Citroen

UNIT PACKAGE: 25



**22432**

(Chrysler: 68093998-AA; Fiat: 71728806;  
Citroen & Peugeot: 856543)  
White Nylon

Body Side Moulding Clip with Sealer  
Top Head Size: 11mm x 12mm  
Bottom Head Size: 15mm x 19mm  
(Including the Sealer)  
Stem Diameter: 10.3mm  
Stem Length: 13mm  
Fiat, Citroen, Peugeot,  
Chrysler Postal Minivan Vehicles &  
Dodge Ram Promaster 2014 - On

UNIT PACKAGE: 25



**21953**

(Peugeot & Citroen: 9147.15)  
Black Nylon

Door Lock Rod Clip  
Used on Left-Hand Side  
Rod Size: 4mm  
Peugeot & Citroen

UNIT PACKAGE: 25



**21950**

Black Nylon

Weatherstrip Retainer  
Head Size: 5mm x 15mm  
Stem Diameter: 7.3mm  
Stem Length: 11mm  
Peugeot & Citroen

UNIT PACKAGE: 25



**21925**

Blue Nylon

Door Lock Rod Clip  
Rod Size: 3mm  
Peugeot, Citroen,  
Renault & Dacia

UNIT PACKAGE: 15



**21951**

(Peugeot & Citroen: 9147.14)  
Black Nylon

Door Lock Rod Clip  
Rod Size: 3mm  
Used on Left-Hand Side  
Peugeot & Citroen

UNIT PACKAGE: 25



**21954**

(Peugeot & Citroen: 9147.21)  
White Nylon

Door Lock Rod Clip  
Rod Size: 3mm  
Peugeot & Citroen

UNIT PACKAGE: 25

## HAND SANDING PADS

- Non-woven pads impregnated with resin and grain for a variety of applications
- Best for hand sanding parts, removing rust & cleaning/prepping surfaces



**22379**

Gray

Width: 6"  
Length: 9"  
Grit: Ultra Fine

UNIT PACKAGE:  
1 (set of 10)



**22380**

Maroon

Width: 6"  
Length: 9"  
Grit: Medium

UNIT PACKAGE:  
1 (set of 10)

# ABRASIVES & ACCESSORIES

*Photos not actual size*



## Surface Conditioning Discs



- Non-woven nylon fiber embedded with aluminum oxide abrasive grain
- For general grinding, blending, rust removal, clean-up and paint removal
  - Thicker, longer lasting material
- Fast & easy to change twist-to-lock mounting

Auveco Part No.	Size	Grade	Color	RPM	Unit Pkg.
22374	2"	Coarse	Brown	25,000	25
22375	2"	Medium	Maroon	25,000	25
22376	2"	Fine	Blue	25,000	25
22377	3"	Coarse	Brown	20,000	25
22378	3"	Medium	Maroon	20,000	25

## Mini Grinding Discs



- Premium blue Zirconia grain bonded onto a tough resin backing
- Long-life on regular steels & stainless steels
  - Best for weld grinding and finishing
- Fast & easy to change twist-to-lock mounting

Auveco Part No.	Size	Grit	RPM	Unit Pkg.
22381	2"	24	25,000	25
22382	2"	36	25,000	25
22383	2"	50	25,000	25
22384	2"	80	25,000	25
22385	3"	24	20,000	25
22386	3"	36	20,000	25
22387	3"	50	20,000	25
22388	3"	80	20,000	25

## Strip-Brite Disc



- Typically used for paint and coating removal
  - Quick & easy twist-to-lock mounting
  - Open-web construction impregnated with silicon carbide, provides aggressive and long-lasting performance
- Durable, three-dimensional web has a soft edge to remove paint and other coatings without damaging the metal, especially on aluminum

Auveco Part No.	Size	Color	Unit Pkg.
22391	3"	Purple	1

## Twist-to-Lock Holders

- For use with mini grinding, surface conditioning & strip-brite discs
  - 1/4" Shank



**22389**

For 2" Discs

UNIT PACKAGE: 1



**22390**

For 3" Discs

UNIT PACKAGE: 1

**Sec. 1**

**TAPPING SCREWS**

Listed According to Size



**Phillips Oval Head Tapping Screws**



Size	Zinc Part No.	Chrome Part No.	Bk. Oxide Part No.	Unit Pkg.
4 x 3/8"	<b>3062</b>		<b>12893</b>	100
4 x 1/2"	<b>3063</b>	<b>3068</b>	<b>12894</b>	100
4 x 5/8"			<b>12895</b>	100
4 x 3/4"		<b>3069</b>	<b>12896</b>	100
4 x 1"			<b>12897</b>	100
6 x 3/8" 4 Hd		<b>2802</b>		100
6 x 1/2"	<b>2571</b>	<b>2698</b>	<b>12795</b>	100
6 x 5/8"	<b>2699</b>	<b>1793</b>		100
6 x 3/4"	<b>2700</b>	<b>1794</b>	<b>12796</b>	100
6 x 7/8"	<b>2572</b>			100
6 x 1"	<b>2702</b>	<b>1796</b>	<b>12797</b>	100
6 x 1-1/4"	<b>2704</b>	<b>1797</b>	<b>12798</b>	100
8 x 3/8" 6 Hd	<b>2705</b>	<b>2024</b>		100
8 x 3/8"	<b>3484</b>			100
8 x 1/2" 6 Hd	<b>2706</b>	<b>2027</b>	<b>10162</b>	100
8 x 1/2"	<b>2358</b>	<b>2707</b>	<b>10163</b>	100
8 x 5/8" 6 Hd		<b>1421</b>		100
8 x 5/8"	<b>2574</b>	<b>2709</b>		100
8 x 3/4" 6 Hd	<b>1798</b>	<b>1799</b>	<b>10164</b>	100
8 x 3/4"	<b>2359</b>	<b>2710</b>	<b>10165</b>	100
8 x 3/4" 10 Hd		<b>20373</b>		100
8 x 7/8" 6 Hd	<b>1800</b>	<b>2711</b>		100
8 x 7/8"	<b>2575</b>	<b>2712</b>		100
8 x 1" 6 Hd	<b>1801</b>	<b>1483</b>	<b>10166</b>	100
8 x 1"	<b>2360</b>	<b>2713</b>	<b>10167</b>	100
8 x 1-1/8" 6 Hd		<b>1802</b>		100
8 x 1-1/4" 6 Hd	<b>1803</b>	<b>1423</b>	<b>10168</b>	100
8 x 1-1/4"	<b>2361</b>	<b>2716</b>	<b>10169</b>	100
8 x 1-1/2" 6 Hd	<b>2717</b>	<b>1932</b>	<b>10170</b>	100
8 x 1-1/2" 6 Hd		<b>1424</b>		100
(Special Long Shank)				
8 x 1-1/2"	<b>2362</b>	<b>2718</b>	<b>10171</b>	100
8 x 1-3/4" 6 Hd		<b>1933</b>		100
8 x 2" 6 Hd	<b>2632</b>			100

Size	Zinc Part No.	Chrome Part No.	Bk. Oxide Part No.	Unit Pkg.
8 x 2"	<b>2633</b>			100
8 x 2-1/2"	<b>3205</b>			100
10 x 1/2" 6 Hd	<b>2720</b>	<b>2656</b>		100
10 x 1/2" 8 Hd		<b>2657</b>		100
10 x 1/2"	<b>2579</b>	<b>2722</b>	<b>11084</b>	100
10 x 5/8" 8 Hd		<b>2724</b>		100
10 x 5/8"	<b>2580</b>			100
10 x 3/4" 6 Hd	<b>2726</b>			100
10 x 3/4" 8 Hd	<b>2727</b>	<b>1717</b>	<b>11087</b>	100
10 x 3/4"	<b>2581</b>	<b>2728</b>	<b>11086</b>	100
10 x 1" 6 Hd	<b>2729</b>	<b>1804</b>		100
10 x 1" 8 Hd	<b>2578</b>	<b>2730</b>	<b>11089</b>	100
10 x 1"	<b>2582</b>	<b>2731</b>	<b>11088</b>	100
10 x 1-1/4" 8 Hd	<b>2661</b>	<b>2734</b>	<b>11091</b>	100
10 x 1-1/4"	<b>2583</b>	<b>2735</b>	<b>11090</b>	100
10 x 1-1/2" 6 Hd		<b>2046</b>		100
10 x 1-1/2" 8 Hd		<b>20374</b>		100
10 x 1-1/2"	<b>2585</b>		<b>11092</b>	100
10 x 1-3/4"	<b>2586</b>			100
10 x 2" 8 Hd	<b>2665</b>			100
10 x 2"	<b>2666</b>			100
10 x 2-1/2"	<b>3207</b>			100
12 x 1/2"	<b>8044</b>			100
12 x 3/4"	<b>8050</b>			100
12 x 1"	<b>8056</b>			100
12 x 1-1/2"	<b>8062</b>			100
12 x 2"	<b>8068</b>			100
14 x 1"	<b>8083</b>			100

For assortments of Phillips Oval Head Tapping Screws, refer to Fix-Kits 6003 and 6501 in the green pages.



**Phillips Oval Head Tek<sup>®</sup> Tapping Screws**  
Phosphate

Auveco Part No.	Size	Unit Pkg.
<b>16736</b>	8 x 1" 6 Hd	50



**Slotted Oval Head Tapping Screws**  
Bright Zinc Chromate

Auveco Part No.	Size	Unit Pkg.
<b>1432</b>	6 x 1/2"	100
<b>1149</b>	8 x 3/4"	100
<b>1137</b>	8 x 1"	100
<b>5616</b>	12 x 5/8"	100
<b>5617</b>	14 x 5/8"	100
<b>5618</b>	14 x 2-1/4"	100



# TAPPING SCREWS

Listed According to Size



## Pop On Polypropylene Screw Covers & Bases

### They're simple to use:

1. Place washer over pilot or starting hole for screw, nail or rivet.
2. Install fastener.
3. Place Snap Cap over washer at slight angle.
4. Simply push Snap Cap down firmly.

### Covers



Auveco Part No.	Screw Size	Color	O.D.	Unit Pkg.
13831	#4	Black	1/2"	50
13832	#4	White	1/2"	50
13833	#6	Black	1/2"	50
13834	#6	White	1/2"	50
13835	#8	Black	5/8"	50
13836	#8	White	5/8"	50
13837	#10	Black	5/8"	50
13838	#10	White	5/8"	50

### Bases



Auveco Part No.	Size	Use with Cover	Unit Pkg.
13839	#4	13831 & 13832	50
13840	#6	13833 & 13834	50
13841	#8	13835 & 13836	50
13842	#10	13837 & 13838	50

## Metric Torx® Head Tapping Screws 300 Series Stainless Steel



Auveco Part No.	Size	Head Style	Finish	Unit Pkg.
14053	4.2 x 25mm	M7 Oval	Black Ox	50



## Phillips Flat Head Tapping Screws

Size	Zinc Part No.	Unit Pkg.	Bk. Oxide Part No.	Unit Pkg.
4 x 1/4"	5646	100		
4 x 3/8"	5647	100	12899	100
4 x 1/2"	5648	100	12900	100
4 x 5/8"	5649	100		
4 x 3/4"	5650	100		
6 x 5/16"	4 Hd 2736	100		
6 x 1/2"	4 Hd 5651	100		
6 x 1/2"	1946	100	12801	100
6 x 5/8"	5653	100		
6 x 3/4"			12802	100
6 x 1"			12803	100
8 x 3/8"	6 Hd 5654	100		
8 x 7/16"	6 Hd 1479	100		
8 x 1/2"	6 Hd 2804	100	10173	100
8 x 1/2"	5655	100	10172	100
8 x 5/8"	6 Hd 5656	100		
8 x 3/4"	6 Hd 1712	100	10174	100
8 x 3/4"	2807	100	10175	100
8 x 1"	6 Hd 5660	100	10176	100
8 x 1"	5661	100	10177	100
8 x 1-1/4"	6 Hd		10178	100
8 x 1-1/4"			10179	100
8 x 1-1/2"			12806	50
10 x 1/2"			12807	100
10 x 3/4"	2810	100	12809	100
10 x 1"	5672	100	12811	50



## Torx® Insert Bits for Torx Screws 1" Shank

Auveco Part No.	Bit Size	For Screw Size	Unit Pkg.
12472	T-10	No. 4	1
11949	T-15	No. 6, 8, M4.2	1
11950	T-20	No. 8, M4.2	1
12103	T-25	No. 10	1
14913	T-27	No. 12, 1/4"	1
12104	T-30	1/4"	1
12105	T-40	5/16"	1
14916*	T-55	1/2", 9/16", 5/8"	1

\*1-1/4 Shank

### Torx Tools

Torx Short Arm Key, Power Drive Bits and Hand Drivers are available for installing Torx Screws. Refer to the "Tools" listing in the Alphabetical Index.

**Sec. 1**

**TAPPING SCREWS**

Listed According to Size



**Slotted Pan Head Tapping Screws**  
Bright Zinc Chromate

Auveco Part No.	Size	Unit Pkg.
3020	4 x 1/4"	100
3022	4 x 1/2"	100
1263	6 x 3/8"	100
1452	6 x 1/2"	100
1453	6 x 5/8"	100
1454	6 x 3/4"	100
1455	6 x 1"	100
1456	8 x 3/8"	100
1146	8 x 1/2"	100
1092	8 x 5/8"	100
1457	8 x 1"	100
3028	8 x 1-1/2"	100
1458	10 x 1/2"	100
1787	10 x 5/8"	100
1265	10 x 3/4"	100
1459	10 x 1"	100
1460	10 x 1-1/2"	100
1266	10 x 1-3/4"	100
1344	12 x 3/4"	100
1346	12 x 1"	100
3032	12 x 1-1/2"	100
1347	14 x 1/2"	100
1381	14 x 3/4"	100
1382	14 x 1"	100



**Phillips Pan Head Tapping Screws**

Size	Zinc Part No.	Unit Pkg.	Bk. Oxide Part No.	Unit Pkg.
4 x 1/4"	3071	100	12902	100
4 x 3/8"	3072	100	12903	100
4 x 1/2"	3073	100	12904	100
4 x 5/8"	5619	100		
4 x 3/4"	3074	100	12905	100
4 x 1"	3075	100		
6 x 1/4"	1935	100		
6 x 3/8"	1936	100	16889	100
6 x 1/2"	1937	100	11917	100
6 x 5/8"	5621	100		
6 x 3/4"	2364	100	11918	100
6 x 1"	3076	100	11919	100
6 x 1-1/8"	5623	100		
6 x 1-1/4"	3077	100	11920	100
6 x 1-1/2"	3078	100		
8 x 3/8"	1939	100		
8 x 1/2"	1940	100	10180	100
8 x 5/8"	5625	100		
8 x 3/4"	2365	100	10181	100
8 x 7/8"	5626	100		
8 x 1"	3079	100	10182	100
8 x 1-1/4"	3080	100	10183	100
8 x 1-1/2"	3081	100	12799	50
10 x 3/8"	1942	100		
10 x 1/2"	1943	100	11921	100
10 x 5/8"	2808	100		
10 x 3/4"	2366	100	11922	100
10 x 7/8"	5629	100		
10 x 1"	3082	100	11923	50
10 x 1-1/4"	3083	100	11924	50
10 x 1-1/2"	3084	100	12800	50
12 x 1/2"	3085	100		
12 x 5/8"	5630	100		
12 x 3/4"	2367	100		
12 x 1"	3086	100		
12 x 1-1/4"	3087	100		
12 x 1-1/2"	3088	100		
14 x 1/2"	3089	100		
14 x 5/8"	5632	100		
14 x 3/4"	3090	100		
14 x 7/8"	5633	100		
14 x 1"	3091	100		
14 x 1-1/4"	3092	100		
14 x 1-1/2"	3093	100		
14 x 1-3/4"	3211	100		
14 x 2"	5634	100		

**GET THE KIT THAT FITS**

We have several assortments in the green section.

Find the kit that holds the screws you use the most.

For assortments of Phillips Pan Head Tapping Screws refer to Fix Kits 6004 and 6038 in the green pages.

# TAPPING SCREWS

Listed According to Size



## Phillips Oval Head Sems® Countersunk Washer Tapping Screws

Size	Chrome Part No.	Unit Pkg.	Bk. Phos. Part No.	Unit Pkg.
6 x 5/8"	<b>3537</b>	100	<b>11784</b>	100
6 x 3/4"	<b>3538</b>	100	<b>11785</b>	100
6 x 1"	<b>3539</b>	100	<b>11786</b>	100
8 x 1/2"	6 Hd		<b>*16930</b>	100
8 x 5/8"	6 Hd	100	<b>11787</b>	100
8 x 3/4"	6 Hd	100	<b>11788</b>	100
8 x 1"	6 Hd	100	<b>11789</b>	100
8 x 1-1/4"	6 Hd	100	<b>11790</b>	100
8 x 1-1/2"	6 Hd	50		
10 x 5/8"	8 Hd	100	<b>14972</b>	100
10 x 3/4"	8 Hd	100	<b>11791</b>	50
10 x 1"	8 Hd	100	<b>11792</b>	50
10 x 1-1/4"	8 Hd	100	<b>14973</b>	50

\*Black Oxide Finish



## Phillips Oval Head Sems® Flush Washer Tapping Screws

Size	Chrome Part No.	Bk. Oxide Part No.	Unit Pkg.
8 x 1/2"	6 Hd	<b>12956</b>	100
8 x 5/8"	6 Hd	<b>2774</b>	100
8 x 11/16"	6 Hd	<b>10653</b>	100
8 x 7/8"	6 Hd	<b>2775</b>	100
8 x 1"	6 Hd	<b>12957</b>	100
8 x 1-1/4"	6 Hd	<b>10654</b>	100



Countersunk



Flush

## Phillips Oval Head Sems® Teks® Finishing Screws with No. 6 Head & No. 2 Drill Point

Size	Washer Type	Chrome Part No.	Phos. Part No.	Unit Pkg.
8 x 5/8"	Flush	<b>11448</b>	<b>11453</b>	100
8 x 5/8"	Ctrsnk	<b>11449</b>	<b>11454</b>	100
8 x 3/4"	Ctrsnk	<b>11450</b>	<b>11455</b>	100
8 x 1"	Ctrsnk	<b>11451</b>	<b>11456</b>	50
8 x 1-1/4"	Ctrsnk	<b>11452</b>	<b>11457</b>	50
8 x 1-1/4"	Flush		<b>18460</b>	50



## Phillips Flat Top Washer Head Tapping Screws Black E-Coat or Zinc

Size	Washer Head O.D.	Zinc Part No.	Black E-Coat Part No.	Unit Pkg.
6 x 1/2"	3/8"		<b>12950</b>	100
6 x 3/4"	3/8"		<b>*12951</b>	100
6 x 1"	3/8"		<b>*12952</b>	100
8 x 1/2"	13/32"	<b>14859</b>	<b>12213</b>	100
8 x 5/8"	13/32"	<b>14860</b>	<b>12214</b>	100
8 x 3/4"	13/32"	<b>14861</b>	<b>12215</b>	100
8 x 1"	13/32"	<b>14862</b>	<b>12216</b>	100
8 x 1-1/4"	13/32"		<b>12217</b>	50
8 x 1-1/2"	13/32"		<b>12218</b>	50
8 x 2"	13/32"		<b>19798</b>	50
10 x 3/4"	15/32"		<b>12953</b>	50
10 x 1"	15/32"		<b>12954</b>	50
10 x 1-1/4"	15/32"		<b>12955</b>	50

\*Black Oxide Finish



## Phillips Pan Head Sems® Tapping Screws Black Phosphate

Auveco Part No.	Size	Washer O.D.	Unit Pkg.
<b>12818</b>	8 x 1/2"	1/2"	50
<b>12820</b>	8 x 3/4"	1/2"	50



## Slotted Pan Head Type F Thread Cutting Screws Bright Zinc Chromate

Auveco Part No.	Size	Unit Pkg.
<b>5290</b>	8-32 x 1/4"	100
<b>5291</b>	8-32 x 3/8"	100
<b>5292</b>	8-32 x 1/2"	100
<b>5298</b>	10-24 x 3/8"	100
<b>5301</b>	10-24 x 3/4"	100
<b>5307</b>	1/4"-20 x 5/8"	100



**Sec. 1**

**TAPPING SCREWS**

Listed According to Size



**Acorn Indented Hex Washer Head Tapping Screws with Phillips Recess**

Auveco Part No.	Size	Hex Size	Washer O.D.	Finish	Unit Pkg.
13727	6 x 3/4"	1/4"	5/16"	Zinc	100
13728	6 x 1"	1/4"	5/16"	Zinc	100



**Drill Screws**  
Bright Zinc Chromate  
Pinch Point

**Slotted Hex Washer Head Tapping Screws**

Auveco Part No.	Size	Hex Size	Unit Pkg.
3367	6 x 3/8"	1/4"	100
3374	8 x 1/2"	1/4"	100
3376	8 x 3/4"	1/4"	100

Use Auveco Magnetic Socket Tool No. 7767



**Self-Piercing Screws**

Zinc

For material thickness up to .060  
Use with magnetic chuck 7767

Auveco Part No.	Size	Hex Size	Unit Pkg.
12367	8 x 5/8"	1/4"	100
12368	8 x 3/4"	1/4"	50
12369	10 x 1/2"	1/4"	50
12370	10 x 3/4"	1/4"	50



**Hexagon Washer Head Type F Thread Cutting Screws**  
Bright Zinc Chromate

Auveco Part No.	Size	Hex Size	Unit Pkg.
5759	6-32 x 3/8"	1/4"	100
5764	6-32 x 1"	1/4"	100
5766	8-32 x 3/8"	1/4"	100
5767	8-32 x 1/2"	1/4"	100
5768	8-32 x 5/8"	1/4"	100
5769	8-32 x 3/4"	1/4"	100
5773	10-24 x 3/8"	5/16"	100
5774	10-24 x 1/2"	5/16"	100
5775	10-24 x 5/8"	5/16"	100
5776	10-24 x 3/4"	5/16"	100
5778	10-24 x 1"	5/16"	100
8437	12-24 x 1/2"	5/16"	100
8438	12-24 x 3/4"	5/16"	100
8439	12-24 x 1"	5/16"	100
5781	1/4"-20 x 3/8"	3/8"	100
5782	1/4"-20 x 1/2"	3/8"	100
5783	1/4"-20 x 5/8"	3/8"	100
5784	1/4"-20 x 3/4"	3/8"	100
5786	1/4"-20 x 1"	3/8"	100
5787	1/4"-20 x 1-1/4"	3/8"	100
8441	5/16"-18 x 1/2"	1/2"	100
8442	5/16"-18 x 3/4"	1/2"	100
8443	5/16"-18 x 1"	1/2"	100
8444	5/16"-18 x 1-1/4"	1/2"	100
15355	5/16"-18 x 1-1/2"	1/2"	50
15356	5/16"-18 x 1-3/4"	1/2"	50
11294	3/8"-16 x 3/4"	9/16"	50
11295	3/8"-16 x 1"	9/16"	50
11296	3/8"-16 x 1-1/4"	9/16"	25
11297	3/8"-16 x 1-1/2"	9/16"	25
15357	3/8"-16 x 1-3/4"	9/16"	25
15358	3/8"-16 x 2"	9/16"	25

**Need help identifying your screw? Please see pages 41-43.**

**You will find charts of screw head styles, driving recesses and point styles.**

**There is also brief descriptions of some common fastener terminology, as well as, plating and finish types with descriptions for each. You will also find a tapping screw diameter, head size and identification chart with an accurate to size ruler to measure your screw.**

# TAPPING SCREWS

Listed According to Size

**Sec. 1**



## Teks® Self-Drilling Self-Tapping Screws

Size	Hex Size	Zinc Part No.	Unit Pkg.	Bk. Oxide Part No.	Unit Pkg.
<b>Phillips Pan Head</b>					
#2 Teks Point					
8 x 7/16"		<b>9604</b>	100		
8 x 1/2"		<b>9605</b>	100	<b>16033</b>	100
8 x 3/4"		<b>9606</b>	100	<b>16034</b>	100
8 x 1"		<b>11904</b>	100	<b>16035</b>	50
10 x 1/2"		<b>9607</b>	100	<b>16036</b>	50
10 x 3/4"		<b>9608</b>	100	<b>16037</b>	50
10 x 1"		<b>9609</b>	100	<b>16038</b>	50
12 x 1"		<b>11905</b>	50		

<b>Hex Washer Head</b>					
#2 Teks Point					
8 x 7/16"	1/4"	<b>9610</b>	100		
8 x 1/2"	1/4"	<b>9611</b>	100	<b>16039</b>	100
8 x 3/4"	1/4"	<b>9612</b>	100	<b>16040</b>	100
8 x 1"	1/4"	<b>11906</b>	100	<b>16041</b>	50
8 x 1-1/2"	1/4"	<b>11908</b>	50		
10 x 1/2"	5/16"	<b>9613</b>	100	<b>16042</b>	50
10 x 5/8"	5/16"	<b>9614</b>	100		
10 x 3/4"	5/16"	<b>9615</b>	100	<b>16043</b>	50
10 x 1"	5/16"	<b>9616</b>	100	<b>16044</b>	50

<b>Super Teks® Hex Washer Head</b>					
#3 Teks Point					
10 x 1-1/4"	5/16"	<b>11909</b>	50		
10 x 1-1/2"	5/16"	<b>11910</b>	50		
12 x 3/4"	5/16"	<b>9617</b>	100		
12 x 1"	5/16"	<b>11911</b>	25		
12 x 1-1/4"	5/16"	<b>11912</b>	25		
12 x 1-1/2"	5/16"	<b>11913</b>	25		
14 x 3/4"	3/8"	<b>9620</b>	100		
14 x 1"	3/8"	<b>11914</b>	25		
14 x 1-1/4"	3/8"	<b>11915</b>	25		
14 x 1-1/2"	3/8"	<b>11916</b>	25		

Screw Size	#2 Point	#3 Point
#8	.035" - .100"	.100" - .140"
#10	.035" - .110"	.110" - .175"
#12	.035" - .140"	.110" - .210"
#14	.035" - .175"	.110" - .210"

For an assortment of Teks Tapping Screws, see Fix-Kit No. 6144 in the green pages.

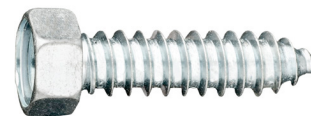

## Indented Hex Head Tapping Screws Bright Zinc Chromate

Auveco Part No.	Size	Hex Size	Unit Pkg.
<b>2389</b>	8 x 1/2"	1/4"	100
<b>2485</b>	8 x 3/4"	1/4"	100
<b>3212</b>	8 x 1-1/4"	1/4"	100
<b>2487</b>	10 x 3/4"	5/16"	100
<b>3214</b>	10 x 1-1/4"	5/16"	100
<b>3215</b>	10 x 1-1/2"	5/16"	100
<b>1780</b>	12 x 1/2"	5/16"	100
<b>2107</b>	12 x 3/4"	5/16"	100
<b>3216</b>	12 x 1"	5/16"	100
<b>3217</b>	12 x 1-1/4"	5/16"	100
<b>2012</b>	14 x 1/2"	3/8"	100
<b>1781</b>	14 x 3/4"	3/8"	100
<b>2109</b>	14 x 3/4"	7/16"	100
<b>2266</b>	14 x 1"	7/16"	100
<b>2267</b>	14 x 1-1/4"	7/16"	100
<b>3219</b>	14 x 1-1/2"	7/16"	100
<b>2110</b>	5/16" x 3/4"	1/2"	100
<b>2268</b>	5/16" x 1"	1/2"	100
<b>2269</b>	5/16" x 1-1/4"	1/2"	100
<b>3220</b>	5/16" x 1-1/2"	1/2"	100
<b>5329</b>	3/8" x 3/4"	9/16"	50
<b>5330</b>	3/8" x 1"	9/16"	50
<b>5331</b>	3/8" x 1-1/4"	9/16"	50
<b>5332</b>	3/8" x 1-1/2"	9/16"	50



## Phillips Oval Head Teks® Tapping Screws Phosphate

Auveco Part No.	Size	Unit Pkg.
<b>16736</b>	8 x 1" 6 Hd	50

**Sec. 1**

**TAPPING SCREWS**

Listed According to Size



**Hexagon Washer Head Tapping Screws**

Washer attached solid to Head

Size	Hex Size	Zinc Part No.	Unit Pkg.	Bk. Oxide Part No.	Unit Pkg.
10 x 1/2"	5/16"	2369	100	16149	100
10 x 5/8"	5/16"	2809	100		
12 x 5/8"	5/16"	2967	100		
12 x 3/4"	5/16"	2968	100		
12 x 1"	5/16"	2969	100		
14 x 1/2"	3/8"	9825	100		
14 x 5/8"	3/8"	2370	100		
14 x 3/4"	3/8"	2330	100	16152	100
14 x 3/4"	7/16"	2973	100		
14 x 1"	3/8"	2974	100		
14 x 1-1/2"	3/8"	2976	100		
5/16" x 3/4"	7/16"	2978	100		
5/16" x 1"	7/16"	2979	100		
5/16" x 1-1/4"	7/16"	2980	100		
5/16" x 1-1/2"	7/16"	2981	100		



**Hexagon Head Sems® Tapping Screws**

Bright Zinc Chromate  
Washer loose from Head

Auveco Part No.	Size	Hex Size	Washer O.D.	Unit Pkg.
2604	14 x 3/4"	3/8"	5/8"	100
2988	14 x 3/4"	7/16"	21/32"	100
2605	14 x 1"	3/8"	21/32"	100
2989	14 x 1"	7/16"	21/32"	100
2991	14 x 1-1/2"	7/16"	21/32"	100
2994	5/16" x 1"	7/16"	11/16"	100
2996	5/16" x 1-1/2"	7/16"	11/16"	100



**Slotted Hexagon Washer Head Tapping Screws**

Bright Zinc Chromate

Auveco Part No.	Size	Hex Size	Unit Pkg.
3367	6 x 3/8"	1/4"	100
3368	6 x 1/2"	1/4"	100
3369	6 x 5/8"	1/4"	100
3373	8 x 3/8"	1/4"	100
3374	8 x 1/2"	1/4"	100
3375	8 x 5/8"	1/4"	100
3376	8 x 3/4"	1/4"	100
3378	8 x 1"	1/4"	100
3379	8 x 1-1/4"	1/4"	100
3380	10 x 3/8"	5/16"	100
3381	10 x 1/2"	5/16"	100
3382	10 x 5/8"	5/16"	100
3383	10 x 3/4"	5/16"	100
3385	10 x 1"	5/16"	100
3386	10 x 1-1/4"	5/16"	100
3387	10 x 1-1/2"	5/16"	100
3388	12 x 1/2"	5/16"	100
3389	12 x 5/8"	5/16"	100
3390	12 x 3/4"	5/16"	100
3392	12 x 1"	5/16"	100
3393	12 x 1-1/4"	5/16"	100
3394	12 x 1-1/2"	5/16"	100



**Hex Head Lag Screws**  
Zinc Plated

Auveco Part No.	Size	Hex Size	Unit Pkg.
9091	5/16" x 2-1/2"	1/2"	50
9100	3/8" x 4"	9/16"	25



# TAPPING SCREWS

Listed According to Size



**Phillips Square Combo Drive Teks® Liner Screws with Locking Wedges under Head**  
Zinc & Yellow

Auveco Part No.	Size	Head Dia.	Unit Pkg.
21731	10 x 3/4"	5/8"	50
21732	10 x 1"	5/8"	50
21733	10 x 1-1/4"	5/8"	50



**Torx® Wafer Head Teks® Liner Screws**  
Zinc

Auveco Part No.	Size	Head Dia.	Drive Size	Unit Pkg.
21734	10 x 3/4"	15/32"	T-25	50
21735	10 x 1"	15/32"	T-25	50
21736	10 x 1-1/4"	15/32"	T-25	50
21737	10 x 1-1/2"	15/32"	T-25	50



**Flat Head Torx® Drive Floor Screws**  
Type F Thread Cutting Point  
Phosphate & Oil

Auveco Part No.	Size	Drive Size	Unit Pkg.
21717	1/4"-20 x 2"	T-30	50
21718	1/4"-20 x 2-1/2"	T-30	50
21719	1/4"-20 x 3"	T-30	25
21720	1/4"-20 x 3-1/2"	T-30	25
21721	1/4"-20 x 4"	T-30	15
21722	1/4"-20 x 5"	T-30	15
21723	1/4"-20 x 6"	T-30	15

Auveco Part No.	Size	Drive Size	Unit Pkg.
21725	5/16"-18 x 2-1/4"	T-40	25
21726	5/16"-18 x 2-1/2"	T-40	25
21727	5/16"-18 x 3"	T-40	15
21728	5/16"-18 x 3-1/2"	T-40	15
21729	5/16"-18 x 4"	T-40	10
21730	5/16"-18 x 5"	T-40	10

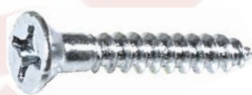

**Phillips Flat Head Wood Screws**  
Steel • Zinc Plated

Auveco Part No.	Size	Unit Pkg.
9555	6 x 1/2"	100
9556	6 x 3/4"	100
9557	6 x 1"	100
9564	8 x 3/4"	100
9565	8 x 1"	100
9566	8 x 1-1/4"	100
9568	8 x 1-3/4"	100
9569	10 x 3/4"	100
9570	10 x 1"	100

Auveco Part No.	Size	Unit Pkg.
9571	10 x 1-1/4"	100
9572	10 x 1-1/2"	100
9575	12 x 1"	100
9576	12 x 1-1/4"	100
9577	12 x 1-1/2"	100
9578	12 x 2"	100
9581	14 x 1-1/2"	100
9582	14 x 2"	100

**Sec. 2**

**MACHINE SCREWS**



**Hex Washer Head Spin Lock Bolts**  
Grade 2 • Phosphate

Auveco Part No.	Size	Hex	Washer Head O.D.	Unit Pkg.
<b>2753*</b>	1/4"-20 x 5/8"	3/8"	5/8"	100
<b>3615</b>	5/16"-18 x 3/4"	1/2"	13/16"	100
<b>5711</b>	5/16"-18 x 1"	1/2"	13/16"	50
<b>5713</b>	5/16"-18 x 1-1/4"	1/2"	13/16"	50
<b>2688</b>	5/16"-24 x 1"	1/2"	13/16"	50

\*Not Dog Point



**Slotted Oval Head Machine Screws**  
Zinc Plated

Auveco Part No.	Size	Unit Pkg.
<b>2354</b>	10-24 x 1-1/2"	100

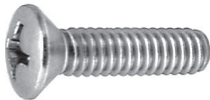

**Phillips Oval Head Machine Screws**  
Steel • Zinc Plated

Size	Chrome Part No.	Zinc Part No.	Unit Pkg.
6-32 x 3/8"		<b>16362</b>	100
6-32 x 1/2"		<b>16363</b>	100
6-32 x 3/4"		<b>16364</b>	100
6-32 x 1-1/4"		<b>16365</b>	100
8-32 x 1/2"	<b>2299</b>	<b>16368</b>	100
8-32 x 3/4"		<b>16369</b>	100
8-32 x 3/4"	6 Hd	<b>1863</b>	100
8-32 x 1"		<b>16370</b>	100
8-32 x 1-1/4"		<b>16371</b>	100
8-32 x 1-1/2"		<b>16372</b>	50
10-24 x 1/2"		<b>1877</b>	100
10-24 x 3/4"	<b>1934</b>	<b>16375</b>	100
10-24 x 1"		<b>16376</b>	100
10-24 x 1-1/4"		<b>16377</b>	100
10-24 x 1-1/2"		<b>16378</b>	100
10-32 x 1/2"		<b>16380</b>	100
10-32 x 3/4"		<b>16381</b>	100
10-32 x 1"	8 Hd	<b>1413</b>	100
10-32 x 1"		<b>16382</b>	100
10-32 x 1-1/4"		<b>16383</b>	50
10-32 x 1-1/2"		<b>16384</b>	50
1/4"-20 x 1/2"		<b>16385</b>	50
1/4"-20 x 3/4"		<b>16386</b>	50
1/4"-20 x 1"		<b>16387</b>	50
1/4"-20 x 1-1/2"		<b>16389</b>	50

For the most up to date information on all Auveco items, including new items, inventory and online ordering please visit [www.auveco.com](http://www.auveco.com)



**Slotted Round Head Machine Screws**  
Plain Brass

Auveco Part No.	Size	Unit Pkg.
<b>3854</b>	10-24 x 1"	100
<b>3859</b>	10-32 x 5/8"	100



**Round Head Stove Bolts & Hex Nuts**  
Bright Zinc Chromate  
U.S.S. Coarse Thread

Auveco Part No.	Size	Unit Pkg.
<b>5697</b>	1/8" x 1"	100
<b>3711</b>	3/16" x 1/2"	100
<b>3712</b>	3/16" x 3/4"	100
<b>3713</b>	3/16" x 1"	100
<b>3715</b>	3/16" x 1-1/2"	100
<b>3716</b>	3/16" x 1-3/4"	100
<b>3717</b>	3/16" x 2"	100
<b>3718</b>	1/4" x 1/2"	100
<b>3719</b>	1/4" x 3/4"	100
<b>3720</b>	1/4" x 1"	100
<b>3722</b>	1/4" x 1-1/2"	100
<b>3724</b>	1/4" x 2"	100

**MACHINE SCREWS****Sec. 2**
**Phillips Pan Head Machine Screws**  
 Zinc Plated

Auveco Part No.	Size	Unit Pkg.
15374	6-32 x 3/8"	100
15375	6-32 x 1/2"	100
15376	6-32 x 3/4"	100
15377	6-32 x 1"	100
15378	6-32 x 1-1/4"	100
15379	6-32 x 1-1/2"	100
15380	8-32 x 3/8"	100
15381	8-32 x 1/2"	100
15382	8-32 x 3/4"	100
15383	8-32 x 1"	100
15385	8-32 x 1-1/2"	100
15386	10-24 x 3/8"	100
15387	10-24 x 1/2"	100
15388	10-24 x 3/4"	100
15389	10-24 x 1"	100
15390	10-24 x 1-1/4"	100
15391	10-24 x 1-1/2"	50
15392	10-32 x 3/8"	100
15393	10-32 x 1/2"	100
15394	10-32 x 3/4"	100
15395	10-32 x 1"	100
15396	10-32 x 1-1/4"	100
15397	10-32 x 1-1/2"	50
15398	1/4"-20 x 1/2"	100
15399	1/4"-20 x 3/4"	100
15400	1/4"-20 x 1"	50
15401	1/4"-20 x 1-1/4"	50
15402	1/4"-20 x 1-1/2"	50
15403	1/4"-20 x 1-3/4"	50
15404	1/4"-20 x 2"	50

**Slotted Round Head Machine Screws**  
 Bright Zinc Chromate

Auveco Part No.	Size	Unit Pkg.
5700	6-32 x 3/8"	100
2530	6-32 x 1/2"	100
2531	6-32 x 3/4"	100
2532	6-32 x 1"	100
8588	6-32 x 1-1/2"	100
5702	8-32 x 3/8"	100
2533	8-32 x 1/2"	100
2534	8-32 x 3/4"	100
2535	8-32 x 1"	100
8589	8-32 x 1-1/2"	100
8590	10-32 x 3/8"	100
2536	10-32 x 1/2"	100
2537	10-32 x 3/4"	100
2538	10-32 x 1"	100
2539	10-32 x 1-1/4"	100
2540	10-32 x 1-1/2"	100
2541	10-24 x 1/2"	100
2542	10-24 x 3/4"	100
2543	10-24 x 1"	100
2544	10-24 x 1-1/4"	100
2545	10-24 x 1-1/2"	100
8594	10-24 x 2"	100
2546	12-24 x 1/2"	100
5704	12-24 x 3/4"	100
2548	12-24 x 1"	100
2550	12-24 x 1-1/2"	100
8029	1/4"-20 x 1/2"	100
8030	1/4"-20 x 3/4"	100
8031	1/4"-20 x 1"	100
8033	1/4"-20 x 1-1/2"	100
8035	1/4"-20 x 2"	100
8036	1/4"-20 x 2-1/2"	100

For assortments of Slotted Round Head Machine Screws refer to Fix Kits 6011 and 6503 in the green pages.

**Phillips Round Head Machine Screws**  
 Zinc Plated

Auveco Part No.	Size	Unit Pkg.
16407	6-32 x 1/2"	100
16411	8-32 x 1"	100
16412	10-32 x 1/2"	100
16413	10-32 x 3/4"	100
16416	10-24 x 3/4"	100

Visit  
**www.auveco.com**  
 for easy quick online ordering



**Sec. 2**

**MISCELLANEOUS SCREWS**

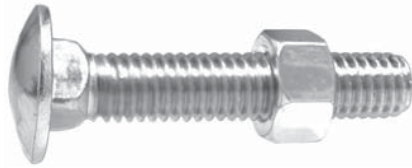

**Carriage Bolts with Hex Nuts**

U.S.S. Coarse Thread • Grade 2 • Zinc Plated

Auveco Part No.	Size	Unit Pkg.
9482	1/4" x 1"	50
9483	1/4" x 1-1/2"	50
9484	1/4" x 2"	50
9485	1/4" x 2-1/2"	50
9486	1/4" x 3"	50
9487	1/4" x 4"	25
9489	1/4" x 6"	25
9490	5/16" x 1"	50
9491	5/16" x 1-1/2"	50
9492	5/16" x 2"	25

Auveco Part No.	Size	Unit Pkg.
9493	5/16" x 3"	25
9494	5/16" x 4"	25
9498	3/8" x 1"	25
9499	3/8" x 1-1/2"	25
9500	3/8" x 2"	25
9501	3/8" x 3"	25
9502	3/8" x 4"	25
9507	1/2" x 2"	10
9509	1/2" x 4"	10
9510	1/2" x 6"	10

**Socket Head Set Screws**  
Cup Point



Auveco Part No.	Size	Unit Pkg.	Use Tool No.
5365	6-32 x 3/16"	50	5414
5366	6-32 x 1/4"	50	5414
5367	6-32 x 5/16"	50	5414
5368	6-32 x 3/8"	50	5414
5369	8-32 x 3/16"	50	5415
5370	8-32 x 1/4"	50	5415
5371	8-32 x 5/16"	50	5415
5372	8-32 x 3/8"	50	5415
5373	8-32 x 1/2"	50	5415

Part No. U.S.S.	Part No. S.A.E.	Size	Unit Pkg.	Use Tool No.
<b>5/16"</b> U.S.S. (Coarse) Threads Per Inch: 18 S.A.E. (Fine) Threads Per Inch: 24				
5384	5404	5/16 x 1/4"	50	7977*
5385	5405	5/16 x 5/16"	50	7977*
5386	5406	5/16 x 3/8"	50	7977*
5387	5407	5/16 x 7/16"	50	7977*
5388	5408	5/16 x 1/2"	50	7977*

Part No. U.S.S.	Part No. S.A.E.	Size	Unit Pkg.	Use Tool No.
<b>#10</b> U.S.S. (Coarse) Threads Per Inch: 24 S.A.E. (Fine) Threads Per Inch: 32				
5374	5394	10 x 3/16"	50	
5375	5395	10 x 1/4"	50	
5376	5396	10 x 5/16"	50	
5377		10 x 3/8"	50	
5378	5398	10 x 1/2"	50	

Part No. U.S.S.	Part No. S.A.E.	Size	Unit Pkg.	Use Tool No.
<b>3/8"</b> U.S.S. (Coarse) Threads Per Inch: 16 S.A.E. (Fine) Threads Per Inch: 24				
5389	5409	3/8 x 5/16"	25	7978*
5390	5410	3/8 x 3/8"	25	7978*
5391	5411	3/8 x 7/16"	25	7978*
5392	5412	3/8 x 1/2"	25	7978*
5393	5413	3/8 x 5/8"	25	7978*

Part No. U.S.S.	Part No. S.A.E.	Size	Unit Pkg.
<b>1/4"</b> U.S.S. (Coarse) Threads Per Inch: 20 S.A.E. (Fine) Threads Per Inch: 28			
5379	5399	1/4 x 1/4"	50
5380	5400	1/4 x 5/16"	50
5381	5401	1/4 x 3/8"	50
5382	5402	1/4 x 7/16"	50
5383	5403	1/4 x 1/2"	50

Part No. U.S.S.	Part No. S.A.E.	Size	Unit Pkg.	Use Tool No.
<b>7/16"</b> U.S.S. (Coarse) Threads Per Inch: 14 S.A.E. (Fine) Threads Per Inch: 20				
15898	15905	7/16 x 3/8"	25	7978*
<b>1/2"</b> U.S.S. (Coarse) Threads Per Inch: 13 S.A.E. (Fine) Threads Per Inch: 20				
15903		1/2 x 1/2"	25	7978*
	15910	1/2 x 5/8"	25	7978*

\*Fold-up Key Set

Note: All Socket Wrenches packed 10 per Unit Package except Key Sets 7977 & 7978 which are packed 1 per Unit Package

For an assortment of Socket Head Set Screws, see Fix-Kit No. 6073 in the green pages.

# GRADE 8 HEX FLANGE PRODUCT FOR FRAME BOLTING

## Sec. 2

### All Items Phosphate & Oil

Auveco flange bolts and locknuts form a strong and dependable fastening system that substantially cuts truck assembly, maintenance and repair costs. The flange bolts are made to IFI 111 industry standard specifications. When flange bolts are used in conjunction with the flange locknuts they form a 150,000 P.S.I. tensile strength fastening system equivalent to SAE J429, Grade 8 industry standard specification. Flat washers and lock washers are not needed with the flange bolts. Our flange fastening system also reduces the need for costly hole preparations such as deburring and countersinking.



### Product Specifications

Product Diameter	Flange & Nut Diameter	Screw & Nut Across Flats	Screw Head Height	Nut Height	Minimum Screw Thread Length
3/8"	.780"/.810"	.551"/.562"	.370"/.390"	.415"/.425"	1"
1/2"	1.031"/1.070"	.736"/.750"	.490"/.510"	.545"/.555"	1-1/4"
5/8"	1.300"/1.330"	.922"/.937"	.600"/.620"	.680"/.690"	1-1/2"
3/4"	1.510"/1.565"	1.110"/1.125"	.710"/.730"	.740"/.750"	1-3/4"

### Grade 8 Hex Flange Bolts

Size	Auveco Part No. U.S.S.	U.S.S. Unit Pkg.	Auveco Part No. S.A.E.	S.A.E. Unit Pkg.	Size	Auveco Part No. U.S.S.	U.S.S. Unit Pkg.	Auveco Part No. S.A.E.	S.A.E. Unit Pkg.
<b>3/8"</b>	U.S.S. (Coarse) Threads Per Inch: 16				<b>5/8"</b>	U.S.S. (Coarse) Threads Per Inch: 11 S.A.E. (Fine) Threads Per Inch: 18			
3/8 x 1"	17561*	25			5/8 x 1-1/2"	17576*	10	14493*	10
3/8 x 1-1/4"	17562*	25			5/8 x 1-3/4"	17577*	10	14494*	10
3/8 x 1-1/2"	17563	25			5/8 x 2"	17578*	10	14495*	10
3/8 x 1-3/4"	17564	25			5/8 x 2-1/4"	17579*	10	14496*	10
<b>1/2"</b>	U.S.S. (Coarse) Threads Per Inch: 13 S.A.E. (Fine) Threads Per Inch: 20				5/8 x 2-1/2"	17580	10	14497	10
1/2 x 1"	17565*	25	14487*	10	5/8 x 2-3/4"			14498	10
1/2 x 1-1/4"	17566*	25			5/8 x 3"	17582	10	14499	10
1/2 x 1-1/2"	17567*	25	14489*	10	5/8 x 3-1/2"	17584	10		
1/2 x 1-3/4"	17568*	25	14490*	10					
1/2 x 2"	17569	15	14491	10					
1/2 x 2-1/4"	17570	15							
1/2 x 2-1/2"	17571	15							
1/2 x 3"	17573	15							
1/2 x 3-1/4"	17574	15							
1/2 x 3-1/2"	17575	15							

\*Items threaded to the head

### Hex Flange Locknuts

Auveco Part No.	Size	Unit Pkg.	Auveco Part No.	Size	Unit Pkg.
12517	3/8"-16 (Coarse)	50	12519	5/8"-11 (Coarse)	25
12518	1/2"-13 (Coarse)	25	14501	5/8"-18 (Fine)	25
14500	1/2"-20 (Fine)	25	15180	3/4"-10 (Coarse)	10

## Sec. 2

## CAP SCREWS



Grade 5



Bright Zinc Chromate  
Medium Carbon Heat Treated Steel

120,000 P.S.I. Minimum Tensile Strength, Head is identified with 3 Radial Lines

Size	Part No. U.S.S.	Part No. S.A.E.	Unit Pkg.
<b>1/4"</b>	U.S.S. (Coarse) Threads Per Inch: 20 S.A.E. (Fine) Threads Per Inch: 28		
1/4 x 1/2"	*5434	*5495	100
1/4 x 5/8"	*5435		100
1/4 x 3/4"	*5436	*5497	100
1/4 x 1"	*5438	*5499	100
1/4 x 1-1/4"	5439	5500	100
1/4 x 1-1/2"	5440	5501	100
1/4 x 1-3/4"	5441		100
1/4 x 2"	5442		100
1/4 x 2-1/4"	5443		100
1/4 x 2-1/2"	5444	5505	100
1/4 x 2-3/4"	5445		100
1/4 x 3"	5446		100
1/4 x 3-1/2"	8449		100

Size	Part No. U.S.S.	Part No. S.A.E.	Unit Pkg.
<b>5/16"</b>	U.S.S. (Coarse) Threads Per Inch: 18 S.A.E. (Fine) Threads Per Inch: 24		
5/16 x 1/2"	*5447		100
5/16 x 5/8"	*5448		100
5/16 x 3/4"	*5449	*5510	100
5/16 x 7/8"	*5450		100
5/16 x 1"	*5451	*5512	100
5/16 x 1-1/4"	*5452	*5513	100
5/16 x 1-1/2"	5453	5514	100
5/16 x 1-3/4"	5454		100
5/16 x 2"	5455	5516	50
5/16 x 2-1/4"	5456		50
5/16 x 2-1/2"	5457		50
5/16 x 3"	5459		50
5/16 x 3-1/2"	5461		50
5/16 x 4"	8450		50

Size	Part No. U.S.S.	Part No. S.A.E.	Unit Pkg.
<b>3/8"</b>	U.S.S. (Coarse) Threads Per Inch: 16 S.A.E. (Fine) Threads Per Inch: 24		
3/8 x 5/8"	*5462		50
3/8 x 3/4"	*5463	*5524	50
3/8 x 7/8"	*5464		50
3/8 x 1"	*5465	*5526	50
3/8 x 1-1/4"	*5466	*5527	50
3/8 x 1-1/2"	5467	5528	50
3/8 x 1-3/4"	5468		50
3/8 x 2"	5469	5530	50
3/8 x 2-1/4"	5470		50
3/8 x 2-1/2"	5471		50
3/8 x 3"	5472	5533	50
3/8 x 3-1/2"	5473		50
3/8 x 4"	5474		50
3/8 x 4-1/2"	8096		25
3/8 x 5"	8097		25

\*Items threaded to head

Size	Part No. U.S.S.	Part No. S.A.E.	Unit Pkg.
<b>7/16"</b>	U.S.S. (Coarse) Threads Per Inch: 14 S.A.E. (Fine) Threads Per Inch: 20		
7/16 x 3/4"	*5475		50
7/16 x 1"	*5476	*5537	50
7/16 x 1-1/4"	*5477	*5538	50
7/16 x 1-1/2"	*5478	*5539	50
7/16 x 1-3/4"	5479		50
7/16 x 2"	5480		25
7/16 x 2-1/2"	5481	5542	25
7/16 x 3"	5482		25
7/16 x 3-1/2"	5483		25
7/16 x 4"	5484		25

Size	Part No. U.S.S.	Part No. S.A.E.	Unit Pkg.
<b>1/2"</b>	U.S.S. (Coarse) Threads Per Inch: 13 S.A.E. (Fine) Threads Per Inch: 20		
1/2 x 3/4"	*5485		50
1/2 x 1"	*5486	*5547	50
1/2 x 1-1/4"	*5487		50
1/2 x 1-1/2"	*5488		25
1/2 x 1-3/4"	*5489	*5550	25
1/2 x 2"	5490	5551	25
1/2 x 2-1/2"	5491		25
1/2 x 3"	5492	5553	25
1/2 x 3-1/2"	5493		25
1/2 x 4"	5494		25
1/2 x 4-1/2"	8104		25
1/2 x 5"	8105		25
1/2 x 6"	8107		25

Size	Part No. U.S.S.	Part No. S.A.E.	Unit Pkg.
<b>5/8"</b>	U.S.S. (Coarse) Threads Per Inch: 11 S.A.E. (Fine) Threads Per Inch: 18		
5/8 x 1"	*9520		25
5/8 x 1-1/2"	*9521	*9528	25
5/8 x 2"	*9522	*9529	25
5/8 x 2-1/2"	9523		25
5/8 x 3"	9524		25
5/8 x 3-1/2"	9525		25
5/8 x 4"	9526		25

Size	Part No. U.S.S.	Part No. S.A.E.	Unit Pkg.
<b>3/4"</b>	U.S.S. (Coarse) Threads Per Inch: 10		
3/4 x 2"	*8453		10
3/4 x 2-1/2"	*8454		10
3/4 x 3"	8455		10
3/4 x 3-1/2"	8456		10

\*Items threaded to head

Refer to assortment 1020 in the green pages

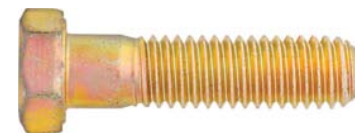

**CAP SCREWS****Sec. 2****Grade 8****Zinc & Yellow Dichromate  
Medium Carbon Alloy Steel****150,000 P.S.I. Minimum Tensile Strength, Head is identified with 6 Radial Lines**

Size	Part No. U.S.S.	Part No. S.A.E.	Unit Pkg.
<b>1/4"</b>	U.S.S. (Coarse) Threads Per Inch: 20 S.A.E. (Fine) Threads Per Inch: 28		
1/4 x 1/2"	<b>*9118</b>		50
1/4 x 3/4"	<b>*9119</b>	<b>*9174</b>	50
1/4 x 1"	<b>*9120</b>		50
1/4 x 1-1/4"	<b>9121</b>		50
1/4 x 1-1/2"	<b>9122</b>	<b>9177</b>	50
1/4 x 2"	<b>9124</b>		50
1/4 x 2-1/4"	<b>9125</b>		25
1/4 x 2-1/2"	<b>9126</b>		25

Size	Part No. U.S.S.	Part No. S.A.E.	Unit Pkg.
<b>5/16"</b>	U.S.S. (Coarse) Threads Per Inch: 18 S.A.E. (Fine) Threads Per Inch: 24		
5/16 x 1/2"	<b>*9127</b>		50
5/16 x 3/4"	<b>*9128</b>		50
5/16 x 1"	<b>*9129</b>	<b>*9184</b>	50
5/16 x 1-1/4"	<b>*9130</b>		50
5/16 x 1-1/2"	<b>9131</b>	<b>9186</b>	50
5/16 x 1-3/4"	<b>9132</b>		50
5/16 x 2"	<b>9133</b>	<b>9188</b>	50
5/16 x 2-1/2"	<b>9134</b>		25
5/16 x 3"	<b>9135</b>		25

Size	Part No. U.S.S.	Part No. S.A.E.	Unit Pkg.
<b>3/8"</b>	U.S.S. (Coarse) Threads Per Inch: 16 S.A.E. (Fine) Threads Per Inch: 24		
3/8 x 3/4"	<b>*9136</b>	<b>*9191</b>	50
3/8 x 1"	<b>*9137</b>	<b>*9192</b>	50
3/8 x 1-1/4"	<b>*9138</b>	<b>*9193</b>	50
3/8 x 1-1/2"	<b>9139</b>	<b>9194</b>	50
3/8 x 2"	<b>9140</b>		25
3/8 x 2-1/2"	<b>9141</b>		25
3/8 x 3"	<b>9142</b>		25
3/8 x 3-1/2"	<b>17028</b>		15
3/8 x 4"	<b>9143</b>		25

\*Items threaded to head

Size	Part No. U.S.S.	Part No. S.A.E.	Unit Pkg.
<b>7/16"</b>	U.S.S. (Coarse) Threads Per Inch: 14 S.A.E. (Fine) Threads Per Inch: 20		
7/16 x 1"	<b>*9144</b>	<b>*9199</b>	25
7/16 x 1-1/4"	<b>*9145</b>		25
7/16 x 1-1/2"	<b>*9146</b>	<b>*9201</b>	25
7/16 x 2"	<b>9147</b>		25
7/16 x 2-1/2"	<b>9148</b>	<b>9203</b>	25
7/16 x 3"	<b>9149</b>		25
7/16 x 4"	<b>9150</b>		25
7/16 x 5-1/2"	<b>17031</b>		10

Size	Part No. U.S.S.	Part No. S.A.E.	Unit Pkg.
<b>1/2"</b>	U.S.S. (Coarse) Threads Per Inch: 13 S.A.E. (Fine) Threads Per Inch: 20		
1/2 x 1"	<b>*9151</b>		25
1/2 x 1-1/4"	<b>*9152</b>		25
1/2 x 1-1/2"	<b>*9153</b>	<b>*9208</b>	25
1/2 x 1-3/4"	<b>*9154</b>		25
1/2 x 2"	<b>9155</b>	<b>9210</b>	25
1/2 x 2-1/2"	<b>9156</b>		25
1/2 x 2-3/4"		<b>17983</b>	10
1/2 x 3"	<b>9157</b>	<b>9212</b>	10
1/2 x 4"	<b>9158</b>		10
1/2 x 5"	<b>9159</b>		10

Size	Part No. U.S.S.	Part No. S.A.E.	Unit Pkg.
<b>5/8"</b>	U.S.S. (Coarse) Threads Per Inch: 11 S.A.E. (Fine) Threads Per Inch: 18		
5/8 x 1-1/2"	<b>*9160</b>		10
5/8 x 2"	<b>*9161</b>		10
5/8 x 2-1/2"	<b>9162</b>		10
5/8 x 3"	<b>9163</b>		10
5/8 x 3-1/2"	<b>17499</b>		10
5/8 x 4"	<b>9164</b>	<b>9219</b>	10
5/8 x 5"	<b>9165</b>		10

Size	Part No. U.S.S.	Part No. S.A.E.	Unit Pkg.
<b>3/4"</b>	U.S.S. (Coarse) Threads Per Inch: 10 S.A.E. (Fine) Threads Per Inch: 16		
3/4 x 2"	<b>*9167</b>		10
3/4 x 3"	<b>9169</b>	<b>9224</b>	10
3/4 x 3-1/2"	<b>9170</b>		10
3/4 x 4"	<b>9171</b>		10
3/4 x 5"	<b>9172</b>		10

\*Items threaded to head

Refer to assortment 1030 in the green pages

**Sec. 2**

**STAINLESS STEEL**

18-8 (300 SERIES)



**Stainless Steel Phillips  
Pan Head Tapping Screws**

Auveco Part No.	Size	Unit Pkg.
13265	6 x 1/2"	100
13266	6 x 3/4"	100
13267	6 x 1"	100
13268	6 x 1-1/4"	100
13269	8 x 1/2"	100
13270	8 x 3/4"	50
13271	8 x 1"	50
13272	8 x 1-1/4"	50
13273	8 x 1-1/2"	25
13274	10 x 1/2"	100
13275	10 x 3/4"	50
13276	10 x 1"	50
13277	10 x 1-1/4"	50
13278	10 x 1-1/2"	25
13279	10 x 1-3/4"	25
13280	12 x 1/2"	50
13281	12 x 3/4"	50
13282	12 x 1"	50
13283	12 x 1-1/4"	25
13284	12 x 1-1/2"	25
21609	14 x 3/4"	100



**Stainless Steel Slotted  
Round Head Machine Screws**

Auveco Part No.	Size	Unit Pkg.
13293	6-32 x 1/4"	100
13294	6-32 x 1/2"	100
13298	8-32 x 1/4"	100
13299	8-32 x 1/2"	100
13300	8-32 x 3/4"	100
13301	8-32 x 1"	100
13302	8-32 x 1-1/4"	50
13304	10-24 x 1/2"	100
13306	10-24 x 1"	50
13308	10-24 x 1-1/2"	50
13310	10-32 x 1/2"	100
13311	10-32 x 3/4"	100
13312	10-32 x 1"	50
13314	10-32 x 1-1/2"	50
13316	1/4"-20 x 3/4"	50



**Stainless Steel Phillips  
Oval Head Tapping Screws**

Auveco Part No.	Size	Unit Pkg.
9399	6 x 1/2"	100
9400	6 x 3/4"	100
9401	6 x 1"	100
9402	6 x 1-1/4"	100
9403	8 x 1/2"	100
9404	8 x 3/4"	100
9405	8 x 1"	100
9406	8 x 1-1/4"	100
9407	8 x 1-1/2"	100
9408	10 x 1/2"	100
9409	10 x 3/4"	100
9410	10 x 1"	100
9411	10 x 1-1/4"	100
9412	10 x 1-1/2"	100
13286	10 x 1-3/4"	25
13288	12 x 3/4"	50
13289	12 x 1"	50
13290	12 x 1-1/4"	25
13291	12 x 1-1/2"	25
13292	12 x 1-3/4"	25



**Stainless Steel Phillips Oval Head  
Machine Screws**

Auveco Part No.	Size	Unit Pkg.
13322	6-32 x 1/2"	100
13323	6-32 x 3/4"	100
13324	6-32 x 1"	100
13325	6-32 x 1-1/4"	100
13326	8-32 x 1/4"	100
13327	8-32 x 1/2"	100
13328	8-32 x 3/4"	100
13329	8-32 x 1"	100
13330	8-32 x 1-1/4"	50
13331	10-24 x 1/2"	100
13332	10-24 x 3/4"	50
13333	10-24 x 1"	50
13334	10-24 x 1-1/4"	50
13335	10-24 x 1-1/2"	50
13336	10-32 x 1/2"	100
13337	10-32 x 3/4"	50
13338	10-32 x 1"	50
13339	10-32 x 1-1/4"	50
13340	10-32 x 1-1/2"	50
13341	1/4"-20 x 1/2"	50
13342	1/4"-20 x 3/4"	50
13343	1/4"-20 x 1"	25
13344	1/4"-20 x 1-1/4"	25
13345	1/4"-20 x 1-1/2"	25

# STAINLESS STEEL

18-8 (300 SERIES)



## U.S.S. Coarse Thread Stainless Steel Hex Head Cap Screws

Auveco Part No.	Bolt Size	Unit Pkg.	Auveco Part No.	Bolt Size	Unit Pkg.
13346*	1/4"-20 x 1/2"	50	13362*	3/8"-16 x 1/2"	50
13347*	1/4"-20 x 3/4"	50	13363*	3/8"-16 x 3/4"	50
13348	1/4"-20 x 1"	50	13364*	3/8"-16 x 1"	50
13349	1/4"-20 x 1-1/4"	50	13365	3/8"-16 x 1-1/4"	25
13350	1/4"-20 x 1-1/2"	50	13366	3/8"-16 x 1-1/2"	25
13352	1/4"-20 x 2"	25	13367	3/8"-16 x 1-3/4"	25
13353*	5/16"-18 x 1/2"	50	13368	3/8"-16 x 2"	25
13354*	5/16"-18 x 3/4"	25	13370	3/8"-16 x 2-1/2"	25
13355	5/16"-18 x 1"	25	13391	3/8"-16 x 3"	25
13356	5/16"-18 x 1-1/4"	25	13373*	1/2"-13 x 1"	10
13357	5/16"-18 x 1-1/2"	25	13374*	1/2"-13 x 1-1/4"	10
13359	5/16"-18 x 2"	25	13375	1/2"-13 x 1-1/2"	10
13360	5/16"-18 x 2-1/4"	25	13377	1/2"-13 x 2"	10
13361	5/16"-18 x 2-1/2"	25			

\*Items threaded to head

## Stainless Steel Cotter Pins Extended Prong Type



Auveco Part No.	Size	Rec. Hole Size	Unit Pkg.	Auveco Part No.	Size	Rec. Hole Size	Unit Pkg.
13409	1/16" x 3/4"	.078	100	13420	1/8" x 1"	.141	50
13410	1/16" x 1"	.078	100	13421	1/8" x 1-1/4"	.141	50
13411	3/32" x 1/2"	.109	100	13422	1/8" x 1-1/2"	.141	50
13412	3/32" x 3/4"	.109	100	13424	1/8" x 2"	.141	25
13413	3/32" x 1"	.109	100	13426	1/8" x 2-1/2"	.141	25
13414	3/32" x 1-1/4"	.109	50	13429	5/32" x 1-1/4"	.172	25
13415	3/32" x 1-1/2"	.109	50	13430	5/32" x 1-1/2"	.172	25
13417	3/32" x 2"	.109	50	13434	5/32" x 2-1/2"	.172	25



## Stainless Steel Wing Nuts

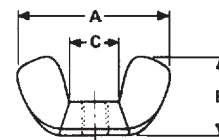

Auveco Part No.	Size	Wing Spread (A)		Overall Height (B)		Between Wing (C)		Unit Pkg.
		Max.	Min.	Max.	Min.	Max.	Min.	
13256	10-24	.91	.78	.47	.34	.27	.22	25
13258	1/4"-20	1.10	.97	.57	.43	.39	.26	25



**Sec. 2****STAINLESS STEEL**

18-8 (300 SERIES)

**Stainless Steel  
Hex Machine Screw Nuts**

Auveco Part No.	Size	Hex Width	Unit Pkg.
13260	6-32	5/16"	100
13261	8-32	11/32"	100
13262	10-24	3/8"	100
13263	10-32	3/8"	100
13264	1/4"-20	7/16"	100

**Stainless Steel Acorn Nuts**

Auveco Part No.	Size	Hex Width	Unit Pkg.
13248	6-32	5/16"	25
13249	8-32	5/16"	25
13251	10-32	3/8"	25
13252	1/4"-20	7/16"	25
13253	5/16"-18	9/16"	10

**Stainless Steel Hex Nuts**

Auveco Part No.	Size	Hex Width	Thick-ness	Unit Pkg.
13234	1/4"-20	7/16"	7/32"	100
13235	5/16"-18	1/2"	17/64"	50
13236	3/8"-16	9/16"	21/64"	50
13237	1/2"-13	3/4"	7/16"	25

**Stainless Steel Nylon Insert Lock Nuts**

Auveco Part No.	Size	Hex Width	Unit Pkg.
13239	6-32	5/16"	50
13240	8-32	11/32"	50
13241	10-24	3/8"	50
13242	10-32	3/8"	50
13243	1/4"-20	7/16"	50
13244	5/16"-18	1/2"	25
13245	3/8"-16	9/16"	25
13246	1/2"-13	3/4"	10

**Stainless Steel Medium Split Washers**

Auveco Part No.	Size	O.D.	Thick-ness	Unit Pkg.
13401	#8	19/64"	.040	100
13402	#10 (3/16")	21/64"	.047	100
13403	1/4"	31/64"	.062	100
13404	5/16"	19/32"	.078	100
13405	3/8"	11/16"	.094	100
13406	1/2"	7/8"	.125	50

**Stainless Steel Flat Washers**

Auveco Part No.	Bolt Size	I.D.	O.D.	Thick-ness	Unit Pkg.
13392	#6 (1/8")	9/64"	3/8"	.030	100
13393	#8	5/32"	3/8"	.030	100
13394	#10 (3/16")	7/32"	7/16"	.030	100
13395	1/4"	9/32"	5/8"	.043	100
13396	5/16"	11/32"	3/4"	.050	100
13397	3/8"	13/32"	7/8"	.060	50
13398	1/2"	33/64"	1-1/4"	.060	50

**WE WELCOME INQUIRES**If you have item suggestions please send them to [mail@auveco.com](mailto:mail@auveco.com)

# BUMPER BOLTS

Listed According to Size

**Round Polished Stainless Steel Capped Heads**  
Zinc Plated



With Lock Nuts



With Hex Nuts

Auveco Part No.	Size	Head Style	Head Diameter		Unit Pkg.
5714*	5/16"-18 x 7/8"	Round	11/16"	without Nuts	25
5238	3/8"-16 x 7/8"	Round	27/32"	without Nuts	25
3414	3/8"-16 x 7/8"	Round	27/32"	with Hex Nuts	25
3432	3/8"-16 x 7/8"	Round	27/32"	with Lock Nuts	25
5239	3/8"-16 x 1"	Round	27/32"	without Nuts	25
3415	3/8"-16 x 1"	Round	27/32"	with Hex Nuts	25
3433	3/8"-16 x 1"	Round	27/32"	with Lock Nuts	25
8626	7/16"-14 x 7/8"	Round	31/32"	without Nuts	25
8627	7/16"-14 x 7/8"	Round	31/32"	with Hex Nuts	25
8552	7/16"-14 x 1"	Round	31/32"	without Nuts	25
8557	7/16"-14 x 1"	Round	31/32"	with Hex Nuts	25
8562	7/16"-14 x 1"	Round	31/32"	with Lock Nuts	25
5242	7/16"-14 x 1-1/4"	Round	31/32"	without Nuts	25
3099	7/16"-14 x 1-1/4"	Round	31/32"	with Hex Nuts	10
3434	7/16"-14 x 1-1/4"	Round	31/32"	with Lock Nuts	25
5243	7/16"-14 x 1-1/2"	Round	31/32"	without Nuts	25
3100	7/16"-14 x 1-1/2"	Round	31/32"	with Hex Nuts	10
3435	7/16"-14 x 1-1/2"	Round	31/32"	with Lock Nuts	25
5246	1/2"-13 x 1-1/2"	Round	1-3/32"	without Nuts	25
3102	1/2"-13 x 1-1/2"	Round	1-3/32"	with Hex Nuts	10
3438	1/2"-13 x 1-1/2"	Round	1-3/32"	with Lock Nuts	25

\* Not Stainless Steel Cap - Chrome Plated

# BUMPER BOLTS



**15545**  
Zinc

1/4"-20 x 3/4"  
Stainless Steel Cap without Nuts  
Head Diameter: 5/8"  
Shoulder Length: 9/64"

UNIT PACKAGE: 25



**16985**  
Zinc

5/16"-18 x 1"  
Stainless Steel Cap without Nuts  
Head Diameter: 3/4"  
Shoulder Length: 3/16"

UNIT PACKAGE: 25



**9853**  
(376337-S100)  
Zinc

5/16"-18 x 3/4"  
Stainless Steel Cap without Nuts  
Head Diameter: 3/4"  
Shoulder Length: 3/16"  
Ford

UNIT PACKAGE: 25



**11614**  
(9433489)  
Zinc

3/8"-16 x 1"  
Stainless Steel Capped Pan Head w/o Nuts  
Head Diameter: 7/8"  
Shoulder Length: 3/32"  
GM

UNIT PACKAGE: 25

**9854**  
Same as 9853 except  
with Hex Nuts  
UNIT PACKAGE: 25

**9855**  
Same as 9853 except  
with Lock Nuts  
UNIT PACKAGE: 25

**11615**  
Same as 11614 except with Hex Nuts  
UNIT PACKAGE: 25

**Sec. 3**

**BUMPER BOLTS**



**10655**  
(6026723)  
Zinc

3/8"-16 x 1"

Stainless Steel Capped Pan Head without Nuts  
Head Diameter: 7/8"  
Shoulder Length: 3/32"  
Chrysler

UNIT PACKAGE: 25

**10656**

Same as 10655 except  
with Hex Nuts  
UNIT PACKAGE: 25

**10657**

Same as 10655 except  
with Lock Nuts  
UNIT PACKAGE: 25



**8623**  
Zinc

7/16"-14 x 1"

Stainless Steel Capped  
Pan Head without Nuts  
Head Diameter: 29/32"  
Shoulder Length: 5/32"  
GM

UNIT PACKAGE: 25

**8624**

Same as 8623 except  
with Hex Nuts  
UNIT PACKAGE: 25

**8625**

Same as 8623 except  
with Lock Nuts  
UNIT PACKAGE: 25



**9354**  
(9786454)  
Zinc

7/16"-14 x 1-3/8"

Stainless Steel Capped  
Pan Head without Nuts  
Head Diameter: 29/32"  
Shoulder Length: 5/32"  
GM

UNIT PACKAGE: 25

**9355**

Same as 9354 except  
with Hex Nuts  
UNIT PACKAGE: 25

**9356**

Same as 9354 except  
with Lock Nuts  
UNIT PACKAGE: 25



**10068**  
(9795883)  
Zinc

7/16"-14 x 1-1/4"

Uncapped Round Head without Nuts  
Head Diameter: 15/16"  
Shoulder Length: 7/32"  
GM

UNIT PACKAGE: 25



**11770**  
(490067)  
Zinc

7/16"-14 x 1-1/2"

Uncapped Round Head without Nuts  
Head Diameter: 15/16"  
Shoulder Length: 3/16"  
GM

UNIT PACKAGE: 25

**11771**

Same as 11770 except with Hex Nuts

UNIT PACKAGE: 25



**16986**  
(14003784)  
Zinc

M8-1.25 x 25mm

Stainless Steel Capped Pan Head without Nuts  
Head Diameter: 19mm  
Shoulder Length: 3mm  
GM

UNIT PACKAGE: 25

**"428" DISPLAY BOARDS**

428 of the most popular body hardware and fastener items are shrink-wrapped onto seven different boards. Each board contains product groups, body shops are familiar with and use often.

The back of each board contains each part number, unit package quantity, OEM number and size specification. The backs are protected by a clear plastic liner.

Learn more about the display boards at the front of the catalog, online at [www.auveco.com](http://www.auveco.com) or contact customer service at 1-800-354-9816 or [mail@auveco.com](mailto:mail@auveco.com)



**BODY BOLTS****Sec. 3****Specification Chart**

Auveco Part No.	Size	Length	Hex Size	Washer Head O.D.	Type	Point Type	Finish	Unit Pkg.	Page No.
<b>2209</b>	#8-32	5/16"		11/32"	Phillips Truss Head	C	Chrome	100	89
<b>2753</b>	1/4"-20	5/8"	3/8"	5/8"	Hex Washer Head Spin Lock	C	Blk Phos	100	77
<b>10823</b>	1/4"-20	7/8"	7/16"	3/4"	Hex Head Sems®	Dog Pt	Blk Phos	50	89
<b>13231</b>	1/4"-20	7/8"	3/8"	5/8"	Hex Washer Head with Sems Nylon Washer	CA	Phosphate Organic	25	89
<b>13232</b>	1/4"-20	7/8"	3/8"	5/8"	Hex Washer Head with Sems Nylon Washer & Jack Nut®	CA	Phosphate Organic	25 Sets	89
<b>17034</b>	1/4"-20	7/8"	7/16"	3/4"	Hex Head Sems	Dog Point	Zinc & Yellow Dichromate	50	89
<b>9757</b>	1/4"-20	1"	3/8"	1"	Hex Head Sems	C	Phosphate	100	89
<b>9480</b>	1/4"-20	1"	7/16"	5/8"	Hex Head Sems	Dog Pt	Phosphate	50	89
<b>14976</b>	1/4"-20	1-1/4"	3/8"	5/8"	Hex Washer Head with Nylon Washer	CA	Stainless Steel Bright Plated	25	89
<b>14977</b>	1/4"-20	1-1/4"	3/8"	5/8"	Hex Washer Head with Nylon Washer & Jack Nut	CA	Stainless Steel Bright Plated	10 Sets	89
<b>2688</b>	5/16"-24	1"	1/2"	13/16"	Hex Washer Head Spin Lock	Dog Pt	Black Phos.	50	77
<b>10084</b>	5/16"-18	3/4"	1/2"	21/32"	Hex Washer Head	CA	Blk Phos	100	89
<b>3615</b>	5/16"-18	3/4"	1/2"	13/16"	Hex Washer Head Spin Lock	Dog Pt	Blk Phos	100	77
<b>10362</b>	5/16"-18	13/16"	1/2"	41/64"	Hex Washer Head	CA	Blk Phos	50	89
<b>15792</b>	5/16"-18	7/8"	1/2"	3/4"	Hex Head Sems	CA	Phos. Organic	50	90
<b>15783</b>	5/16"-18	7/8"	1/2"	3/4"	Hex Head Sems	CA	Phosphate	50	90
<b>5711</b>	5/16"-18	1"	1/2"	13/16"	Hex Washer Head Spin Lock	Dog Pt.	Blk Phos	50	77
<b>9756</b>	5/16"-18	1"	1/2"	7/8"	Hex Head Sems	C	Phosphate	100	90
<b>11320</b>	5/16"-18	1"	1/2"	7/8"	Hex Head Sems	CA	Phosphate	25	90
<b>17035</b>	5/16"-18	1-1/16"	1/2"	7/8"	Hex Head Sems	Dog Pt	Zinc & Yellow Dichromate	25	90
<b>5713</b>	5/16"-18	1-1/4"	1/2"	13/16"	Hex Washer Head Spin Lock	Dog Pt	Blk Phos	50	77
<b>8847</b>	5/16"-18	1-1/4"	1/2"	7/8"	Hex Head Sems	Dog Pt	Blk Phos	50	90
<b>11061</b>	5/16"-18	1-1/4"	1/2"	21/32"	Hex Washer Head	Pinch	Plain	50	90
<b>12009</b>	5/16"-18	1-1/2"	1/2"	21/32"	Hex Washer Head	CA	Phos & Oil	50	90
<b>11109</b>	3/8"-16	1"	9/16"	1"	Hex Head Sems	CA	Phosphate	25	90
<b>11110</b>	3/8"-16	1-3/8"	9/16"	1-1/8"	Hex Head Sems	CA	Phosphate	25	90

**METRIC BODY BOLT CHART APPEARS ON PAGES 121-122**

**Sec. 3**

**BODY BOLTS**



**2209**  
 Chrome  
 #8-32 x 5/16"  
 Phillips Truss Head  
 UNIT PACKAGE: 100



**10823**  
 Black  
 Phosphate  
 1/4"-20 x 7/8"  
 Hex Head Sems® with Dog Point  
 Washer O.D.: 3/4"  
 Hex: 7/16"  
 UNIT PACKAGE: 50



**17034**  
 (57030-S36)  
 Zinc & Yellow Dichromate  
 1/4"-20 x 7/8"  
 Hex Head Sems® with Dog Point  
 Washer O.D.: 3/4"  
 Hex: 7/16"  
 Ford  
 UNIT PACKAGE: 50



**13231**  
 (14007510)  
 Phos. Organic  
 1/4"-20 x 7/8"  
 Hex Washer Head with Sems® Nylon Washer  
 Washer O.D.: 5/8"  
 Hex: 3/8"  
 Truck Mirror Mounting Screw  
 GM  
 UNIT PACKAGE: 25



**13232**  
 (14007510, 367292)  
 Phosphate Organic Screw  
 Zinc with Sealer Jack Nut  
 1/4"-20 x 7/8"  
 Hex Washer Head with Sems® Nylon Washer  
 Washer O.D.: 5/8"  
 Hex: 3/8"  
 Truck Mirror Mounting Screw & Jack Nut  
 GM, Chrysler  
 UNIT PACKAGE: 25 Sets

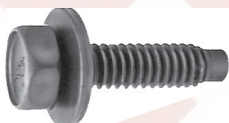

**9480**  
 (6025329)  
 Phosphate  
 1/4"-20 x 1"  
 Hex Head Sems® with Dog Point  
 Washer O.D.: 5/8"  
 Hex: 7/16"  
 Chrysler  
 UNIT PACKAGE: 50

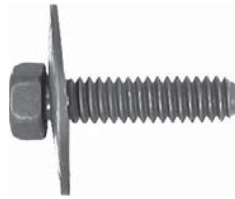

**9757**  
 Phosphate  
 1/4"-20 x 1"  
 Hex Head Sems®  
 Washer O.D.: 1"  
 Hex: 3/8"  
 GM, Ford  
 UNIT PACKAGE: 100



**14976**  
 (367291, 474821, 14007511)  
 400 Series Stainless Steel  
 Bright Plated  
 1/4"-20 x 1-1/4"  
 Hex Washer Head with Nylon Washer  
 Washer O.D.: 5/8"  
 Hex: 3/8"  
 Truck Mirror Mounting Screw  
 GM, Chrysler  
 UNIT PACKAGE: 25



**14977**  
 (367291, 367292,  
 474821, 14007511)  
 400 Series Stainless  
 Steel - Bright Plated Zinc with Sealer Jack Nut  
 1/4"-20 x 1-1/4"  
 Hex Washer Head with Nylon Washer  
 Washer O.D.: 5/8"  
 Hex: 3/8"  
 Truck Mirror Mounting Screw & Jack Nut  
 GM, Chrysler  
 UNIT PACKAGE: 10 Sets



**10084**  
 Black Phosphate  
 5/16"-18 x 3/4"  
 Hex Washer Head  
 Washer Head O.D.: 21/32"  
 Hex: 1/2"  
 GM  
 UNIT PACKAGE: 100



**10362**  
 Black Phosphate  
 5/16"-18 x 13/16"  
 Hex Washer Head  
 Washer Head O.D.: 41/64"  
 Hex: 1/2"  
 GM  
 UNIT PACKAGE: 50

# BODY BOLTS



**15792**  
(1598757, 15686047)  
Phosphate Organic

5/16"-18 x 7/8"  
Indented Hex Head Sems®  
Washer O.D.: 3/4"  
Hex: 1/2"  
GM

UNIT PACKAGE: 50

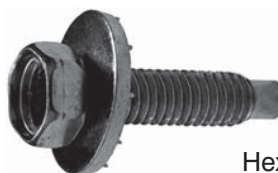

**8847**  
(380575-S2)  
Black Phosphate

5/16"-18 x 1-1/4"  
Hex Head Sems® with Dog Point  
Washer O.D.: 7/8"  
Hex: 1/2"  
Ford

UNIT PACKAGE: 50



**15783**  
(3846202)  
Phosphate

5/16"-18 x 7/8"  
Indented Hex Head Sems®  
Washer O.D.: 3/4"  
Hex: 1/2"  
GM

UNIT PACKAGE: 50



**11061**  
Plain

5/16"-18 x 1-1/4"  
Hex Washer Head  
with Pinch Point  
Washer Head O.D.: 21/32"  
Hex: 1/2"  
Grade 5

UNIT PACKAGE: 50

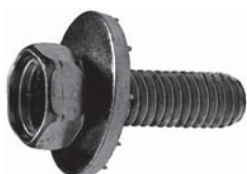

**9756**  
Phosphate

5/16"-18 x 1"  
Hex Head Sems®  
Washer O.D.: 7/8"  
Hex: 1/2"  
GM, Ford

UNIT PACKAGE: 100

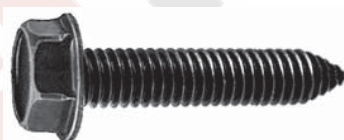

**12009**  
Phosphate & Oil

5/16"-18 x 1-1/2"  
Hex Washer Head  
Washer Head O.D.: 21/32"  
Hex: 1/2"  
GM

UNIT PACKAGE: 50



**11320**  
Phosphate

5/16"-18 x 1"  
Hex Head Sems®  
Washer O.D.: 7/8"  
Hex: 1/2"  
GM, Ford

UNIT PACKAGE: 25



**11109**  
(3986997, 14011722)  
Phosphate

3/8"-16 x 1"  
Hex Head Sems®  
Washer O.D.: 1"  
Hex: 9/16"  
GM

UNIT PACKAGE: 25



**17035**  
(384931-S36)  
Zinc & Yellow Dichromate

5/16"-18 x 1-1/16"  
Hex Head Sems® with Dog Point  
Washer O.D.: 7/8"  
Hex: 1/2"  
Ford

UNIT PACKAGE: 25



**11110**  
(407217, 1564180)  
Phosphate

3/8"-16 x 1-3/8"  
Hex Head Sems®  
Washer O.D.: 1-1/8"  
Hex: 9/16"  
Hood Hinge to Sheet Metal Bolt  
GM

UNIT PACKAGE: 25



**Sec. 4**

**Special Tapping Screw Specification Chart**



Auveco Part No.	Size	Length	Hex Size	Washer/ Head O.D.	Type	Point Type	Finish	Unit Pkg.	Page No.
9877	#4-24	3/8"		7/32"	Phillips Flat Head	AB	Zinc	100	94
10642	#8	3/8"		3/8"	Phillips Oval Washer Head	AB	Zinc	100	94
16997	#8	3/8"		3/8"	Phillips Oval Washer Head	AB	Black E-Coat	100	94
9863	#8	3/8"		9/32"	Phillips Round Washer Head	AB	Zinc	100	94
13707	#8	3/8"		13/32"	Phillips Flat Top Washer Head	AB	Zinc	100	94
8944	#8	3/8"		7/16"	Phillips Washer Head	AB	Chrome	100	94
12062	M4.2 (#8)	10mm (13/32")		11mm (7/16")	Phillips Washer Head, Pozi-Drive	AB	Black Oxide	100	95
2805	#8	7/16"		3/8"	Phillips Washer Head	AB	Zinc	100	95
15037	#8	7/16"		5/16"	Phillips Washer Head	AB	Chrome	100	95
9229	#8	7/16"		9/32"	Phillips Washer Head, Pozi-Drive	AB	Zinc	100	95
1826	#8	7/16"		13/32"	Phillips Truss Head	AB	Chrome	100	95
15941	M4.2 (#8)	12mm (15/32")		9.5mm (3/8")	Phillips Truss Head	AB	Black Oxide	10	95
16596	M4.2 (#8)	12mm (15/32")		9.5mm (3/8")	Phillips Truss Head	AB	Black Oxide	100	95
12739	M4.2 (#8)	12mm (15/32")		10mm (25/64")	Phillips Washer Head, Pozi-Drive	AB	Chrome	100	95
13708	#8	1/2"		13/32"	Phillips Flat Top Washer Head	AB	Zinc	100	95
12213	#8	1/2"		13/32"	Phillips Flat Top Washer Head	AB	Black E-Coat	100	95
13025	#8	1/2"		31/64"	Phillips Washer Head	AB	Phosphate	100	95
20375	#8	1/2"		1/2"	Phillips Round Washer Head	AB	Black Phos.	100	95
15172	#8	1/2"		13/32"	Phillips Washer Head	Teks®	Zinc	100	95
15171	#8	1/2"		23/64"	Phillips Low Profile Round Wash Head	Teks	Zinc	100	96
12095	#8	1/2"		7/16"	Phillips Washer Head	Teks	Zinc	50	96
15774	#8	1/2"		7/16"	Phillips Washer Head	Teks	Black Phos.	50	96
16478	#8	1/2"		13/32"	Phillips Flat Top Round Washer Head	Teks	Black Zinc	100	96
12059	M4.2 (#8)	13mm (33/64")		11mm (7/16")	Phillips Washer Head	AB	Zinc	100	96
12061	M4.2 (#8)	13mm (33/64")		8.5mm (11/32")	Phillips Round Washer Head, Pozi-Drive	AB	Black Oxide	100	96
13712	M4.2 (#8)	13mm (33/64")		11mm (7/16")	Phillips Washer Head	AB	Black Zinc	50	96
12740	M4.2 (#8)	13mm (33/64")	7mm	12mm (15/32")	Hex Head Sems®	AB	Phosphate	100	96
15721	M4.2 (#8)	13mm (33/64")	7mm	16mm (5/8")	Hex Head Sems	AB	Phosphate	50	96
18781	M4.2 (#8)	14mm (9/16")	7mm	8mm (5/16")	Hex Head Sems	AB	Phosphate	50	96
21122	M4.2 (#8)	14mm (9/16")		11mm (7/16")	Phillips Washer Head, Pozi-Drive	Teks	Chrome	50	96
2806	#8	5/8"		13/32"	Phillips Round Washer Head	AB	Chrome	100	96
13711	#8	5/8"		31/64"	Phillips Washer Head	AB	Phosphate	100	97
18817	M4.2 (#8)	16mm (5/8")		11mm (7/16")	Phillips Round Washer Head, Pozi-Drive	Teks	Black Zinc	100	97
16720	M4.2 (#8)	16mm (5/8")		9.5mm (3/8")	Phillips Truss Head	AB	Black Oxide	100	97
12741	M4.2 (#8)	16mm (5/8")	7mm	12mm (15/32")	Hex Head Sems	AB	Phosphate	100	97
18261	M4.2 (#8)	16mm (5/8")	7mm	12mm (15/32")	Hex Washer Head Sems	Teks	Phosphate	50	97
13687	#8	3/4"		9/32"	Phillips Washer Head	AB	Zinc	100	97

(Continued on next page)

# Special Tapping Screw Specification Chart

## Sec. 4



Auveco Part No.	Size	Length	Hex Size	Washer/ Head O.D.	Type	Point Type	Finish	Unit Pkg.	Page No.
13026	#8	3/4"		31/64"	Phillips Washer Head	AB	Phosphate	100	97
17460	#8	3/4"		7/16"	Phillips Round Washer Head	Teks®	Zinc	50	97
17650	#8	3/4"		7/16"	Phillips Round Washer Head	Teks	Phosphate	50	97
16534	#8	3/4"		5/16"	Phillips Pan Head, with Sealer	Teks	Black Zinc	50	97
12060	M4.2 (#8)	20mm (25/32")		11mm (7/16")	Phillips Washer Head	AB	Black Oxide	100	97
12097	M4.2 (#8)	20mm (25/32")		12mm (15/32")	Phillips Pan Head Sems®	AB	Chrome	50	98
12738	M4.2 (#8)	20mm (25/32")	7mm	12mm (15/32")	Hex Washer Head Sems	AB	Phosphate	50	98
12742	M4.2 (#8)	20mm (25/32")	7mm	12mm (15/32")	Hex Head Sems	AB	Phosphate	100	98
15373	M4.2 (#8)	20mm (25/32")	7mm	16mm (5/8")	Hex Head Sems	AB	Phosphate	50	98
20271	M4.2 (#8)	20mm (25/32")		16mm (5/8")	Phillips Pan Head Sems	AB	Phosphate	50	98
20476	M4.2 (#8)	20mm (25/32")	7mm	17mm (11/16")	Hex Washer Head Sems	Teks	Phosphate	50	98
19278	M4.2 (#8)	20mm (25/32")	7mm	20mm (25/32")	Hex Head Sems	AB	Black Phos.	50	98
15775	M4.2 (#8)	20mm (25/32")	7mm	12mm (15/32")	Hex Head Sems	Teks	Phosphate	50	98
22070	M4.2 (#8)	20mm (25/32")		17mm (11/16")	Torx® Pan Head Sems	Dog Pnt	Black Zinc	50	98
22104	M4.2	22mm	5.5mm	16mm	Hex Head Sems	AB	Black Zinc	50	98
18296	#8	1"		7/16"	Phillips Round Washer Head	Teks	Zinc	50	98
19006	M4.2 (#8)	25mm (1")		11mm (7/16")	Pozi-Drive Round Washer Head	Teks	Phosphate	100	99
20382	M4.2 (#8)	25mm (1")	T-15 Drive	12mm (15/32")	Torx® Pan Head Sems	AB	Black Zinc	50	99
22081	M4.2	25mm		17mm	Pozi-Drive Round Washer Head Sems	AB	Black Zinc	50	99
20376	#8	1"		1/2"	Phillips Round Washer Head	AB	Black Phos.	100	99
18336	M4.2 (#8)	25mm (1")	7mm	12mm (15/32")	Hex Head Sems	AB	Black Phos.	100	99
19653	M4.2 (#8)	30mm (1-3/16")	7mm	17mm (11/16")	Hex Head Sems	AB	Black Phos.	15	99
18460	#8	1-1/4"		3/8"	Phillips Oval Head Sems Flush Washer	Teks	Phosphate	50	99
19778	#8	1-1/4"		7/16"	Phillips Round Washer Head	Teks	Zinc	50	99
2178	#10	3/8"		31/64"	Phillips Round Washer Head	AB	Zinc	100	99
2028	#10	1/2"		11/32"	Phillips Round Head	AB	Zinc	100	99
13027	#10	1/2"		15/32"	Phillips Flat Washer Head	AB	Zinc	100	99
15827	#10	1/2"		15/32"	Phillips Flat Washer Head	AB	Phosphate	100	99
18340	M4.8 (#10)	15mm (19/32")		14mm (9/16")	Phillips Truss Head	AB	Black Phos.	50	99
20364	#10	5/8"		7/16"	Phillips Washer Head	Teks	Zinc	100	100
17459	M4.8 (#10)	16mm (5/8")		11mm (7/16")	Phillips Truss Head	AB	Black Oxide	100	100
22030	M4.8 (#10)	16mm (5/8")	8mm	18mm	Hex Head Sems	AB	Black Zinc	50	100
22110	M4.8	18mm	T-25 Drive	15mm	Torx Truss Head	AB	Black Zinc	25	100

(Continued on next page)

**Sec. 4**

**Special Tapping Screw Specification Chart**



Auveco Part No.	Size	Length	Hex Size	Washer/ Head O.D.	Type	Point Type	Finish	Unit Pkg.	Page No.
<b>20259</b>	M4.8 (#10)	19mm (3/4")		16mm (5/8")	Phillips Truss Head Sems®	AB	Black E Coat	25	100
<b>13709</b>	#10	3/4"		15/32"	Phillips Flat Top Washer Head	AB	Zinc	50	100
<b>19240</b>	#10	3/4"		1/2"	Phillips Flat Top Round Washer Head	AB	Black E-Coat	100	100
<b>16589</b>	M4.8 (#10)	19mm (3/4")	8mm	15mm (19/32")	Hex Head Sems	AB	Zinc & Yellow Dichromate	50	100
<b>21774</b>	M4.8 (#10)	20mm (25/32")	8mm	26mm	Hex Head Sems	AB	Black E-Coat	25	100
<b>21865</b>	M4.8 (#10)	32mm (1-1/4")	8mm	19mm (3/4")	Hex Head Sems	AB	Phosphate	50	100
<b>19237</b>	#10	1-1/32"		9/16"	Nylon Phillips Pan Head	AB	Black Nylon	50	100
<b>21746</b>	M5	11mm		11mm	Phillips Truss Head	AB	Black Oxide	50	101
<b>21747</b>	M5	11mm		12mm	Phillips Round Washer Head	AB	Black Oxide	50	101
<b>22294</b>	M5-1.81	16mm	8mm	16mm	Phillips Hex Head Sems		Black Phos.	25	101
<b>22203</b>	M5-1.81	20mm		13mm	Phillips Flat Head		Black Phos.	100	101
<b>22111</b>	M5-2.12 (#12)	19mm (3/4")	T-25 Drive	14mm (9/16")	Torx® Truss Head	AB	Black Zinc	25	101
<b>20455</b>	M5-2.12 (#12)	20mm (25/32")		14mm (9/16")	Phillips Truss Head	AB	Black Phos.	50	101
<b>21841</b>	M5.2 (#12)	20mm (25/32")	8mm	12mm (1/2")	Phillips Hex Head Sems	AB	Black E-Coat	25	101
<b>21839</b>	M5.2 (#12)	21mm (13/16")	10mm	14mm (9/16")	Phillips Hex Head Sems	AB	Zinc	25	101
<b>21541</b>	M5.5 (#12)	20mm (25/32")	T-20 Drive	15mm (19/32")	Torx Truss Head	AB	Black Zinc	25	101
<b>22292</b>	M5.5-1.81 (#12)	16mm (5/8")		13mm	Phillips Truss Head		Black Phos.	25	101
<b>17461</b>	M5.5-1.81 (#12)	18mm (45/64")	8mm	15mm (19/32")	Hex Head Sems	AB	Zinc & Yellow Dichromate	50	101
<b>21744</b>	M6-1.81	20mm	10mm	13mm	Phillips Hex Head Sems	AB	Black E-Coat	25	102
<b>19170</b>	M6.3 (#14)	16mm (5/8")		15mm (19/32")	Phillips Truss Head	AB	Black Phos.	50	102
<b>15776</b>	M6.3 (#14)	16mm (5/8")	8mm	16mm (5/8")	Hex Head Sems	AB	Phosphate	50	102
<b>12057</b>	M6.3 (#14)	16mm (5/8")	10mm	17mm (11/16")	Hex Head Sems	AB	Phosphate	50	102
<b>22106</b>	M6.3	18mm	10mm	14mm	Phillips Hex Head Sems	AB	Zinc	25	102
<b>15962</b>	M6.3 (#14)	18mm (23/32")	10mm	22mm (7/8")	Hex Head Sems	AB	Zinc & Yellow Dichromate	25	102
<b>13021</b>	#14	3/4"	3/8"	1/2"	Hex Washer Head	AB	Phosphate	50	102
<b>13019</b>	M6.3 (#14)	19mm (3/4")	8mm	11.5mm (29/64")	Hex Washer Head	AB	Phosphate	50	102
<b>20556</b>	M6.3 (#14)	20mm (25/32")	10mm	16mm (5/8")	Phillips Hex Head Sems	AB	Black Zinc	50	102
<b>12351</b>	M6.3 (#14)	20mm (25/32")	10mm	17mm (11/16")	Hex Washer Head Sems	AB	Black Phosphate	50	102
<b>16828</b>	M6.3 (#14)	20mm (25/32")	10mm	18mm (45/64")	Hex Head Sems	AB	Zinc & Yellow Dichromate	25	103
<b>20557</b>	M6.3 (#14)	20mm (25/32")	10mm	20mm (25/32")	Phillips Hex Head Sems	AB	Black Zinc	50	103

(Continued on next page)



# Special Tapping Screw Specification Chart



Auveco Part No.	Size	Length	Hex Size	Washer/ Head O.D.	Type	Point Type	Finish	Unit Pkg.	Page No.
<b>18934</b>	#14	7/8"	3/8"	13/16"	Hex Washer Head	AB	Zinc Organic	25	103
<b>21838</b>	M6.3 (#14)	24mm (15/16")	10mm	16mm (5/8")	Phillips Hex Head Sems®	AB	Zinc	25	103
<b>12339</b>	M6.3 (#14)	25mm (1")	10mm	17mm (11/16")	Hex Head Sems	AB	Phosphate	50	103
<b>12354</b>	M6.3 (#14)	30mm (1-3/16")	10mm	17mm (11/16")	Hex Head Sems	AB	Phosphate	50	103
<b>12068</b>	M6.3 (#14)	30mm (1-3/16")	10mm	24mm (15/16")	Hex Head Sems	AB	Phosphate	50	103
<b>22295</b>	M6.5-1.81	18mm		16mm	Phillips Truss Head		Black Phos.	25	103
<b>22296</b>	M6.5-1.81	25mm		16mm	Phillips Truss Head		Black Phos.	25	103
<b>21837</b>	M6.5	19mm	10mm	20mm	Phillips Hex Head Sems	AB	Black E-Coat	25	104
<b>19417</b>	M7.5	35mm (1-3/8")	#3 Sq. Drive	22mm (7/8")	Nylon Square Drive Truss Head	AB	Black Nylon	15	104
<b>12350</b>	M8 (5/16"-12)	20mm (25/32")	13mm	16mm (5/8")	Hex Washer Head	AB	Phosphate	25	104
<b>10364</b>	5/16"-12	7/8"	1/2"	21/32"	Hex Washer Head	AB	Black Oxide	100	104
<b>10714</b>	5/16"-12	1"	1/2"	21/32"	Hex Washer Head	AB	Phosphate	50	104
<b>21517</b>	M9.5	46mm (1-13/16")	#3 Sq. Drive	22mm (7/8")	Nylon Square Drive Truss Head	AB	Black Nylon	25	104
<b>20970</b>	M14 (1-11/32")	34mm Drive	#3 Sq. Drive (7/8")	22mm	Nylon Square Drive Truss Head	AB	Black Nylon	25	104

## SPECIAL TAPPING SCREWS



**9877**  
Zinc

#4-24 x 3/8"  
Special Phillips Flat Head  
Head Diameter: 7/32"  
Use to replace Welded Studs for Moulding Clips  
UNIT PACKAGE: 100



**9863**  
Zinc

#8-18 x 3/8"  
Phillips Round Washer Head  
Head Diameter: 9/32"  
Chrysler  
UNIT PACKAGE: 100



**10642**  
(381671-S)  
Zinc

#8 x 3/8"  
Phillips Oval Washer Head  
Washer Head Outer Diameter: 3/8"  
Wheel Opening Mouldings  
Ford  
UNIT PACKAGE: 100



**13707**  
(9422246)  
Zinc

#8 x 3/8"  
Phillips Flat Top Washer Head  
Washer Head Outer Diameter: 13/32"  
Chrysler  
UNIT PACKAGE: 100



**16997**

Same as 10642 with Black E-Coat  
(168 Hours Salt Spray)  
#8 x 3/8"  
Phillips Oval Washer Head  
Washer Head Outer Diameter: 3/8"  
Wheel Opening Mouldings  
UNIT PACKAGE: 100



**8944**  
Chrome

#8-18 x 3/8"  
Phillips Washer Head  
Washer Head Outer Diameter: 7/16"  
For attaching Chrome Floor Strips  
Ford  
UNIT PACKAGE: 100

**Sec. 4**

**SPECIAL TAPPING SCREWS**



**12062**  
(11501903)  
Black Oxide

M4.2-1.41 x 10mm (#8 x 13/32")  
Phillips Washer Head Pozi-Drive  
Washer Head Outer Diameter: 11mm (7/16")  
GM

UNIT PACKAGE: 100



**12739**  
(11501794)  
Chrome

M4.2-1.41 x 12mm (#8 x 15/32")  
Phillips Washer Head Pozi-Drive  
Washer Head Outer Diameter: 10mm (25/64")  
GM

UNIT PACKAGE: 100



**2805**  
Zinc

#8 x 7/16"  
Phillips Washer Head  
Washer Head Outer Diameter: 3/8"

UNIT PACKAGE: 100



**13708**  
(9422202)  
Zinc

#8 x 1/2"  
Phillips Flat Top Washer Head  
Washer Head Outer Diameter: 13/32"  
Chrysler

UNIT PACKAGE: 100



**15037**  
(588546)  
Chrome

#8 x 7/16"  
Phillips Washer Head  
410 Stainless Steel  
Washer Head Outer Diameter: 5/16"  
Wheel Mouldings  
GM

UNIT PACKAGE: 100



**12213**  
(11503421, 11503636)  
Black E-Coat

#8-18 x 1/2"  
Phillips Flat Washer Head  
Washer Head Outer Diameter: 13/32"  
GM

UNIT PACKAGE: 100



**9229**  
(4879431)  
Zinc

#8-18 x 7/16"  
Phillips Washer Head Pozi-Drive  
Washer Head Outer Diameter: 9/32"  
Wheel Mouldings  
GM

UNIT PACKAGE: 100



**13025**  
(56910-S2)  
Phosphate

#8 x 1/2"  
Phillips Washer Head  
Washer Head Outer Diameter: 31/64"  
Ford

UNIT PACKAGE: 100



**1826**  
Chrome

#8 x 7/16"  
Phillips Truss Head  
Head Diameter: 13/32"

UNIT PACKAGE: 100



**20375**  
Black Phosphate

#8 x 1/2"  
Phillips Round Washer Head  
Head Diameter: 1/2"

UNIT PACKAGE: 100



**15941**  
Black Oxide

M4.2-1.41 x 12mm (#8 x 15/32")  
Phillips Truss Head  
Head Diameter: 9.5mm (3/8")  
Japanese Imports

UNIT PACKAGE: 10



**15172**  
Zinc

#8 x 1/2"  
Phillips Washer Head with #2 Teks® Point  
Washer Head Outer Diameter: 13/32"

UNIT PACKAGE: 100

**16596**

Same as 15491 except for unit package quantity

UNIT PACKAGE: 100

# SPECIAL TAPPING SCREWS

## Sec. 4



**15171**

Zinc

#8 x 1/2"

Phillips Low Profile  
Round Washer Head with #2 Teks® Point  
Washer Head Outer Diameter: 23/64"

UNIT PACKAGE: 100



**13712**

(11505104)  
Black Zinc

M4.2-1.41 x 13mm (#8 x 33/64")  
Phillips Washer Head  
Washer Head Outer Diameter: 11mm (7/16")  
GM

UNIT PACKAGE: 50



**12095**

(1689827)  
Zinc

#8 x 1/2"

Phillips Washer Head with Teks® Point  
Washer Head Outer Diameter: 7/16"  
Reveal Moulding to Panel  
GM

UNIT PACKAGE: 50



**12740**

(11503394)  
Phosphate

M4.2-1.41 x 13mm (#8 x 33/64")  
Hex Head Sems®  
Washer Outer Diameter: 12mm (15/32")  
Hex: 7mm  
GM

UNIT PACKAGE: 100



**15774**

(GM: 20423550)  
(Ford: 381801-S2, 390017-S2)  
Black Phosphate

#8 x 1/2"

Phillips Washer Head with Teks® Point  
Washer Head Outer Diameter: 7/16"  
GM & Ford

UNIT PACKAGE: 50

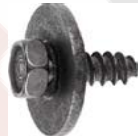

**15721**

(11504010)  
Phosphate

M4.2-1.41 x 13mm (#8 x 19/32")  
Indented Hex Head Sems®  
Washer Outer Diameter: 16mm (5/8")  
Hex: 7mm  
GM

UNIT PACKAGE: 50



**16478**

(153297)  
Black Zinc

#8-18 x 1/2"

Phillips Flat Top Round Washer Head Teks®  
Washer Head Outer Diameter: 13/32"  
Chrysler

UNIT PACKAGE: 100



**18781**

(11515566)  
Phosphate

M4.2-1.41 x 14mm (#8 x 9/16")  
Hex Head Sems®  
Washer Outer Diameter: 8mm (5/16")  
Hex: 7mm  
GM

UNIT PACKAGE: 50



**12059**

(11501883)  
Zinc

M4.2-1.41 x 13mm (#8 x 33/64")  
Phillips Washer Head Pozi-Drive  
Washer Head Outer Diameter: 11mm (7/16")  
GM

UNIT PACKAGE: 100



**21122**

Chrome

M4.2-1.41 x 14mm (#8 x 9/16")  
Phillips Pozi-Drive Washer Head Teks®  
Washer Head Outer Diameter: 11mm (7/16")

UNIT PACKAGE: 50



**12061**

(11501896)  
Black Oxide

M4.2-1.41 x 13mm (#8 x 33/64")  
Phillips Round Washer Head Pozi-Drive  
Washer Head Outer Diameter: 8.5mm (11/32")  
GM

UNIT PACKAGE: 100



**2806**

Chrome

#8 x 5/8"  
Phillips Round Washer Head  
Washer Head Outer Diameter: 13/32"

UNIT PACKAGE: 100



**Sec. 4**

**SPECIAL TAPPING SCREWS**



**13711**

(56911-S2, 56929-S2)  
Phosphate

#8 x 5/8"  
Phillips Washer Head  
Washer Head Outer Diameter: 31/64"  
Ford

UNIT PACKAGE: 100



**13026**

(56912-S2)  
Phosphate

#8 x 3/4"  
Phillips Washer Head  
Washer Head Outer Diameter: 31/64"  
Ford

UNIT PACKAGE: 100



**18817**

(1746408)  
Black Zinc

M4.2-1.41 x 16mm (#8 x 41/64")  
Phillips Round Washer Head  
with Serrations under the Head  
Pozi-Drive with Teks® Point  
Washer Head Outer Diameter: 11mm (7/16")  
Moulding, Trim & General Purpose  
GM

UNIT PACKAGE: 100



**17460**

(382413-S9)  
Zinc

#8 x 3/4"  
Phillips Round Washer Head  
with Teks® Point  
Washer Head Outer Diameter: 7/16"  
Door Scuff Plate  
Ford

UNIT PACKAGE: 50



**16720**

Black Oxide

M4.2-1.41 x 16mm (#8 x 5/8")  
Phillips Truss Head  
Head Outer Diameter: 9.5mm (3/8")  
Honda

UNIT PACKAGE: 100



**17650**

Phosphate

#8 x 3/4"  
Phillips Round Washer Head  
with Teks® Point  
Washer Head Outer Diameter: 7/16"

UNIT PACKAGE: 50



**12741**

(11503395)  
Phosphate

M4.2-1.41 x 16mm (#8 x 5/8")  
Hex Head Sems®  
Washer Outer Diameter: 12mm (15/32")  
Hex: 7mm  
GM

UNIT PACKAGE: 100



**16534**

(154534)  
Black Zinc

#8-18 x 3/4"  
Phillips Pan Head  
with Teks® Point & Sealer  
Head Diameter: 5/16"  
Cargo Door Scuff Plate  
Chrysler Full Size Van

UNIT PACKAGE: 50



**18261**

(11503578, 11503785)  
Phosphate

M4.2-1.41 x 16mm (#8 x 5/8")  
Hex Washer Head Sems® with Teks® Point  
Washer Outer Diameter: 12mm (1/2")  
Hex: 7mm  
GM

UNIT PACKAGE: 50



**12060**

(11501884)  
Black Oxide

M4.2-1.41 x 20mm (#8 x 25/32")  
Phillips Washer Head  
Washer Outer Diameter: 11mm (7/16")  
GM

UNIT PACKAGE: 100



**13687**

Zinc

#8 x 3/4"  
Phillips Washer Head  
Washer Head Outer Diameter: 9/32"

UNIT PACKAGE: 100

# SPECIAL TAPPING SCREWS

## Sec. 4



**12097**

(9420052, 11502483)  
Chrome

M4.2-1.41 x 20mm (#8 x 25/32")  
Phillips Pan Head Sems® Pozi-Drive  
Washer Outer Diameter: 12mm (1/2")  
GM

UNIT PACKAGE: 50



**12738**

(11504056, 11513801)  
Phosphate

M4.2-1.41 x 20mm (#8 x 25/32")  
Hex Washer Head Sems®  
Washer Outer Diameter: 12mm (1/2")  
Hex: 7mm  
Radiator & Grille  
GM

UNIT PACKAGE: 50



**12742**

(11503396, 11503483)  
Phosphate

M4.2-1.41 x 20mm (#8 x 25/32")  
Hex Head Sems®  
Washer Outer Diameter: 12mm (1/2")  
Hex: 7mm  
Front End & Air Conditioner  
GM

UNIT PACKAGE: 100



**15373**

(11503892, 11500434)  
Phosphate

M4.2-1.41 x 20mm (#8 x 25/32")  
Hex Washer Head Sems®  
Washer Outer Diameter: 16mm (5/8")  
Hex: 7mm  
GM

UNIT PACKAGE: 50



**20271**

Phosphate

M4.2-1.41 x 20mm (#8 x 25/32")  
Phillips Pan Head Sems®  
Washer Outer Diameter: 16mm (5/8")  
Ford

UNIT PACKAGE: 50



**20476**

Phosphate

M4.2-1.41 x 20mm (#8 x 25/32")  
Hex Washer Head Sems® Teks®  
Washer Outer Diameter: 17mm (11/16")  
Hex: 7mm  
General Purpose

UNIT PACKAGE: 50



**19278**

(GM: 14090382;  
Chry: 6506161-AA)  
Black Phosphate

M4.2-1.41 x 20mm (#8 x 25/32")  
Hex Head Sems®  
Washer Outer Diameter: 20mm (25/32")  
Hex: 7mm  
GM

UNIT PACKAGE: 50



**15775**

Phosphate

M4.2-1.41 x 20mm (#8 x 25/32")  
Hex Head Sems® with Teks® point  
Washer Outer Diameter: 12mm (1/2")  
Hex: 7mm

UNIT PACKAGE: 50



**22070**

(GM: 11570637)  
Black Zinc

M4.2-1.41 x 20mm (#8 x 25/32")  
Torx® Pan Head Sems®  
Tapping Screw with Dog Point  
T15 Drive  
Washer Outer Diameter: 17mm (11/16")  
GM 2007 - On

UNIT PACKAGE: 50



**22104**

(Ford: N801169-S900;  
W710763-S901)  
Black Zinc

M4.2-1.41 x 22mm  
Hex Head Sems® Tapping Screw  
Washer Diameter: 16mm  
Hex Size: 5.5mm  
Front Bumper Exterior Trim & Front Fender  
Ford Edge & Expedition and Lincoln MKT  
& MKX 1997 - On

UNIT PACKAGE: 50



**18296**

Zinc

#8 x 1"  
Phillips Round Washer Head  
with Teks® Point  
Washer Head Outer Diameter: 7/16"  
General Purpose

UNIT PACKAGE: 50

**Sec. 4**

**SPECIAL TAPPING SCREWS**



**19006**  
Phosphate

M4.2-1.41 x 25mm (#8 x 1")  
Round Washer Head  
Pozi-Drive with Tek's® Point  
Washer Head Outer Diameter: 11mm (7/16")  
General Purpose

UNIT PACKAGE: 100



**20382**  
(Not Available from O.E.M.)  
Black Zinc

M4.2-1.41 x 25mm (#8 x 1")  
Torx® Pan Head Sems®  
T-15 Drive  
Washer Outer Diameter: 12mm (1/2")

UNIT PACKAGE: 50



**22081**  
(GM: 11609762)  
Black Zinc

M4.2-1.41 x 25mm  
Pozi-Drive Round Washer Head Sems®  
Tapping Screw  
Washer Diameter: 17mm  
Chevrolet Equinox, GMC Acadia & Terrain  
and Saturn Outlook 2007 - On

UNIT PACKAGE: 50



**20376**  
Black Phosphate  
#8 x 1"  
Phillips Round Washer Head  
Head Diameter: 1/2"

UNIT PACKAGE: 100



**18336**  
Black Phosphate  
M4.2-1.41 x 25mm (#8 x 1")  
Hex Head Sems®  
Washer Outer Diameter: 12mm (1/2")  
Hex: 7mm

UNIT PACKAGE: 100



**19653**  
(N811534-S61)  
Black Phosphate  
M4.2-1.41 x 30mm (#8 x 1-3/16")  
Hex Head Sems®  
Washer Outer Diameter: 17mm (11/16")  
Hex: 7mm  
Ford

UNIT PACKAGE: 15



**18460**  
Phosphate

#8 x 1-1/4"  
Phillips Oval Head Sems®  
Flush Washer with #2 Tek's® Point  
Washer Outer Diameter: 3/8"  
Interior Trim

UNIT PACKAGE: 50



**19778**  
Zinc

#8 x 1-1/4"  
Phillips Round Washer Head with Tek's® Point  
Washer Head Outer Diameter: 7/16"  
General Purpose

UNIT PACKAGE: 50



**2178**  
Zinc

#10 x 3/8"  
Phillips Round Washer Head  
Washer Head Outer Diameter: 31/64"

UNIT PACKAGE: 100



**2028**  
Zinc

#10 x 1/2"  
Phillips Round Head  
Head Diameter: 11/32"

UNIT PACKAGE: 100



**13027**  
(9428273)  
Zinc

#10 x 1/2"  
Phillips Flat Washer Head  
Washer Head Outer Diameter: 15/32"  
Chrysler

UNIT PACKAGE: 100



**15827**  
(9423950)  
Phosphate

#10 x 1/2"  
Phillips Flat Washer Head  
Washer Head Outer Diameter: 15/32"  
Chrysler

UNIT PACKAGE: 100



**18340**  
Black Phosphate

M4.8-1.6 x 15mm (#10 x 19/32")  
Phillips Truss Head  
Head Outer Diameter: 14mm (9/16")  
Nissan Bumpers

UNIT PACKAGE: 50



# SPECIAL TAPPING SCREWS

## Sec. 4



**20364**

Zinc

#10 x 5/8"

Phillips Washer Head with Teks® Point and serrations under the Washer Head  
Washer Head Outer Diameter: 7/16"  
GM

UNIT PACKAGE: 100



**17459**

Black Oxide

M4.8-1.61 x 16mm (#10 x 5/8")  
Phillips Truss Head  
Head Outer Diameter: 11mm (7/16")  
Imports

UNIT PACKAGE: 100



**22030**

(BMW: 07-14-7-129-160)  
Black Zinc

M4.8-1.61 x 16mm (#10 x 5/8")  
Hex Head Sems®  
Washer Outer Diameter: 18mm  
Hex: 8mm  
BMW, 2013 - 1999

UNIT PACKAGE: 50



**22110**

(VW: N90775801, BMW: 07146963883)  
Black Zinc

M4.8-1.61 x 18mm  
Torx® Truss Head Tapping Screw  
T25 Drive  
Head Diameter: 15mm  
Audi & VW 1998 - On  
BMW 5, 6 & 7 Series 2011 - 00

UNIT PACKAGE: 25



**20259**

(90114-SZ3-000, 90114-SE0-000)  
Black E-Coat

M4.8-1.61 x 19mm (#10 x 3/4")  
Phillips Truss Head Sems®  
Washer Outer Diameter: 16mm (5/8")  
Splash Shield & General Purpose  
Honda 1986 - On

UNIT PACKAGE: 25



**13709**

(9427977)  
Zinc

#10 x 3/4"  
Phillips Flat Top Washer Head  
Washer Head Outer Diameter: 15/32"  
Chrysler

UNIT PACKAGE: 50



**19240**

Black E-Coat

#10 x 3/4"

Phillips Flat Top Round Washer Head  
Washer Head Outer Diameter: 1/2"  
General Purpose

UNIT PACKAGE: 100



**16589**

Zinc & Yellow Dichromate

#10 x 3/4" (19mm)  
Indented Hex Head Sems®  
Washer Outer Diameter: 19/32"  
Hex: 5/16" (8mm)  
Honda, Nissan, Toyota

UNIT PACKAGE: 50



**21774**

(Mercedes-Benz: 201-990-05-36)  
Black E-Coat

M4.8-1.61 x 20mm (#10 x 25/32")  
Hex Head Sems®  
Washer Outer Diameter: 26mm  
Hex: 8mm  
Front Bumper & Moulding Strip  
Mercedes-Benz 2014 - 1993

UNIT PACKAGE: 25



**21865**

(Chrysler: 6509539-AA)  
Phosphate

M4.8-1.61 x 32mm (#10 x 1-1/4")  
Hex Head Sems® Tapping Screw  
Washer Outer Diameter: 19mm (3/4")  
Hex: 8mm  
Chrysler Town & Country and  
Dodge Ram 2014 - 09

UNIT PACKAGE: 50



**19237**

(W701649-S,  
W704881-S300)  
Black Nylon

#10 x 1-1/32"  
Cowl Top Vent Grille Nylon Screw  
Head Outer Diameter: 9/16"  
**Use with Auveco 19238**  
Ford Taurus & Sable 1996 - On

UNIT PACKAGE: 50

**Sec. 4**

**SPECIAL TAPPING SCREWS**



**21746**  
 (Mitsubishi: MF453091)  
 Black Oxide  
 M5-1.59 x 11mm  
 Phillips Truss Head  
 Head Outer Diameter: 11mm  
 Interior Trim  
 Mitsubishi Galant 2008 - 2004  
 UNIT PACKAGE: 50



**21747**  
 Black Oxide  
 M5 - 1.59 x 11mm  
 Phillips Round Washer Head  
 Washer Head Outer Diameter: 12mm  
 Chrysler & Imports  
 UNIT PACKAGE: 50



**22294**  
 (Mazda: 9CF600516B)  
 Black Phosphate  
 M5-1.81 x 16mm  
 Phillips Hex Head Sems®  
 Washer Outer Diameter: 16mm  
 Hex: 8mm  
 Mazda 2, 3, 5, 6, 626, 929, CX-5, CX-7, CX-9, Miata,  
 Millenia, MPV, Mx-3, Protégé, RX-7 & RX-8 2014 - 1992  
 UNIT PACKAGE: 25



**22203**  
 (Honda: 90103-SDA-A00)  
 Black Phosphate  
 M5-1.81 x 20mm  
 Phillips Flat Head  
 Head Diameter: 13mm  
 Front & Rear Bumper  
 Honda Civic, Pilot & Ridgeline 2006 - On  
 UNIT PACKAGE: 100



**22111**  
 (VW: N90892001, N90775001)  
 Black Zinc  
 M5-2.12 x 19mm  
 Torx® Truss Head Tapping Screw  
 T25 Drive  
 Head Diameter: 14mm  
 Audi, Porsche & VW 2014 - 07  
 UNIT PACKAGE: 25



**20455**  
 Black Phosphate  
 M5-2.12 x 20mm (#12 x 25/32")  
 Phillips Truss Head  
 Head Outer Diameter: 14mm (9/16")  
 Imports  
 UNIT PACKAGE: 50



**21841**  
 (Toyota: 75392-42030)  
 Black E-Coat  
 M5.2-2.0 x 20mm (#12 x 25/32")  
 Phillips Hex Head Sems®  
 Washer Outer Diameter: 12mm (1/2")  
 Hex: 8mm  
 Front Bumper Moulding  
 Toyota & Lexus 2010 - On  
 UNIT PACKAGE: 25



**21839**  
 (Toyota: 90159-A0001;  
 90159-50316)  
 Zinc  
 M5.2-2.0 x 21mm (#12 x 13/16")  
 Phillips Hex Head Sems®  
 Washer Outer Diameter: 14mm (9/16")  
 Hex: 10mm  
 Front Bumper, Bumper Stay & Radiator Grille  
 Toyota & Lexus 2000 - On  
 UNIT PACKAGE: 25



**21541**  
 (13144822)  
 Black Zinc  
 M5.5 x 20mm (12 x 25/32")  
 Torx® Truss Head  
 T-20 Drive  
 Head Outer Diameter: 15mm (19/32")  
**Use with Auveco 21539 & 21540**  
 GM 2011 - On  
 Saab 2003 - On  
 UNIT PACKAGE: 25



**22292**  
 (Nissan: 01454-N5061)  
 Black Phosphate  
 M5.5-1.81 x 16mm (#12 x 5/8")  
 Phillips Truss Head  
 Head Outer Diameter: 13mm  
 Fender Liner  
 Nissan Cube, Murano, Pathfinder, Quest,  
 Rogue, Sentra & Versa 2014 - On  
 UNIT PACKAGE: 25



**17461**  
 Zinc & Yellow Dichromate  
 M5.5-1.81 x 18mm (#12 x 45/64")  
 Hex Head Sems®  
 Washer Outer Diameter: 15mm (19/32")  
 Hex: 8mm  
 Imports  
 UNIT PACKAGE: 50

# SPECIAL TAPPING SCREWS

## Sec. 4



### 21744

(Mitsubishi: MS452348)  
Black E-Coat

M6-1.81 x 20mm  
Phillips Hex Head Sems®  
Washer Outer Diameter: 13mm (1/2")  
Hex: 10mm  
Bumper, Exterior Trim,  
Fender Shield and Quarter Panel  
Mitsubishi Diamante, Eclipse, Galant, Lancer,  
Mirage, Montero & 300GT 2012 - 1991

UNIT PACKAGE: 25



### 19170

Black Phosphate

M6.3-1.81 x 16mm (#14 x 5/8")  
Phillips Truss Head  
Head Outer Diameter: 15mm (19/32")  
Japanese Imports

UNIT PACKAGE: 50



### 15776

(N800312-S2)  
Phosphate

M6.3-1.81 x 16mm (#14 x 41/64")  
Hex Head Sems®  
Washer Outer Diameter: 16mm (5/8")  
Hex: 8mm  
Ford

UNIT PACKAGE: 50



### 12057

(11500994, 11509371)  
Phosphate

M6.3-1.81 x 16mm (#14 x 41/64")  
Hex Head Sems®  
Washer Outer Diameter: 17mm (11/16")  
Hex: 10mm  
GM

UNIT PACKAGE: 50



### 22106

(Toyota: 90159-60303)  
Zinc

M6.3-2.5 x 18mm  
Phillips Hex Head Sems® Tapping Screw  
Washer Outer Diameter: 14mm  
Hex: 10mm  
Toyota & Scion 1993 - On

UNIT PACKAGE: 25



### 15962

Zinc & Yellow Dichromate

M6.3-1.81 x 18mm (#14 x 23/32")  
Hex Head Sems®  
Washer Outer Diameter: 22mm (7/8")  
Hex: 10mm  
Honda, Nissan, Toyota

UNIT PACKAGE: 25



### 13021

(55914-S2)  
Phosphate

#14 x 3/4"  
Hex Washer Head  
Washer Head Outer Diameter: 1/2"  
Hex: 3/8"  
Ford

UNIT PACKAGE: 50



### 13019

(N610959-S2)  
Phosphate

M6.3-1.81 x 19mm (#14 x 3/4")  
Hex Washer Head  
Washer Head Outer Diameter: 11.5mm (29/64")  
Hex: 8mm  
Ford

UNIT PACKAGE: 50



### 20556

Black Zinc

M6.3-1.81 x 20mm (#14 x 25/32")  
Phillips Hex Head Sems®  
Washer Outer Diameter: 16mm (5/8")  
Hex: 10mm  
Imports

UNIT PACKAGE: 50

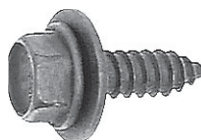

### 12351

(11505022)  
Black Phosphate

M6.3-1.81 x 20mm (#14 x 25/32")  
Hex Washer Head Sems®  
Washer Outer Diameter: 17mm (11/16")  
Hex: 10mm  
GM

UNIT PACKAGE: 50



**Sec. 4**

**SPECIAL TAPPING SCREWS**



**16828**

Zinc & Yellow Dichromate

M6.3-1.81 x 20mm (#14 x 25/32")  
Hex Head Sems®  
Washer Outer Diameter: 18mm (45/64")  
Hex: 10mm  
Honda, Nissan & Toyota

UNIT PACKAGE: 25



**12354**

(11500997)  
Phosphate

M6.3-1.81 x 30mm  
(#14 x 1-3/16")  
Hex Head Sems®  
Washer Outer Diameter: 17mm (21/32")  
Hex: 10mm  
GM

UNIT PACKAGE: 50



**20557**

Black Zinc

M6.3-1.81 x 20mm (#14 x 25/32")  
Phillips Hex Head Sems®  
Washer Outer Diameter: 20mm (25/32")  
Hex: 10mm  
Imports

UNIT PACKAGE: 50



**12068**

(11504981)  
Phosphate

M6.3-1.81 x 30mm  
(#14 x 1-3/16")  
Hex Head Sems®  
Washer Outer Diameter: 24mm(15/16")  
Hex: 10mm  
GM

UNIT PACKAGE: 50



**18934**

(6034703, 6035188)  
Zinc Organic

#14 x 7/8"  
Hex Washer Head  
Serrations under the Washer Head  
Washer Head Outer Diameter: 13/16"  
Hex: 3/8"  
Front Fender & Fascia Attachment  
Chrysler 1993-On

UNIT PACKAGE: 25



**22295**

(Hyundai: 12493-06207B)  
Black Phosphate

M6.5-1.81 x 18mm  
Phillips Truss Head  
Head Outer Diameter: 16mm  
Fender Liner  
Hyundai Accent, Azera, Elantra,  
Entourage, Genesis, I30, Santa Fe,  
Sonata, Tiburon, Tucson, Veloster &  
Veracruz 2013 - 2005

UNIT PACKAGE: 25



**21838**

(Toyota: 90159-60488)  
Zinc

M6.3-2.5 x 24mm (#14 x 15/16")  
Phillips Hex Head Sems®  
Washer Outer Diameter: 16mm (5/8")  
Hex: 10mm  
Front Bumper, Bumper Stay, Hood and Front Fender  
Lexus CT200, ES350, HS250, IS & SC430,  
Scion and Toyota 1995 - On

UNIT PACKAGE: 25



**22296**

(Hyundai: 92155-22000;  
11254-06206)  
Black Phosphate

M6.5-1.81 x 25mm  
Phillips Truss Head  
Head Outer Diameter: 16mm  
Headlamp Assembly Mounting Screw  
Hyundai 2000 - On

UNIT PACKAGE: 25



**12339**

(11500996, 11505023)  
Phosphate

M6.3-1.81 x 25mm (#14 x 1")  
Hex Head Sems®  
Washer Outer Diameter: 17mm (21/32")  
Hex: 10mm  
GM

UNIT PACKAGE: 50



# SPECIAL TAPPING SCREWS



### 21837

(Toyota: 90159-60525)  
Black E-Coat

M6.5-2.5 x 19mm (#14 x 3/4")  
Phillips Hex Head Sems®  
Washer Outer Diameter: 20mm (25/32")  
Hex: 10mm  
Floor Pan & Lower Back Panel Moulding,  
Rear Bumper Stay, Suspension Cross  
Member and Under Cover  
Toyota 1998 - On

UNIT PACKAGE: 25



### 10364

Black Oxide

5/16"-12 x 7/8"  
Hex Washer Head  
Washer Head Outer Diameter: 21/32"  
Hex: 1/2"

UNIT PACKAGE: 100



### 10714

(9796223)  
Phosphate

5/16"-12 x 1"  
Hex Washer Head  
Washer Head Outer Diameter: 21/32"  
Hex: 1/2"  
GM

UNIT PACKAGE: 50



### 19417

(Chry: 6503819, 6503401;  
GM: 25631448)  
Black Nylon

M7.5 x 35mm  
Square Drive Truss Head  
Head Diameter: 22mm  
Shoulder Diameter: 9mm  
Foam to Bumper Fascia  
Chrysler 1993-On  
GM 1997-On

UNIT PACKAGE: 15



### 21517

(GM: 25705182)  
Black Nylon

M9.5 x 46mm  
Bumper Fascia Nylon Screw  
Square Drive  
Head Diameter: 22mm  
GM 2004 - On

UNIT PACKAGE: 25



### 12350

(11500086)  
Phosphate

M8-2.12 x 20mm (5/16"-12 x 25/32")  
Hex Washer Head  
Washer Head Outer Diameter: 16mm (5/8")  
Hex: 13mm  
GM

UNIT PACKAGE: 25



### 20970

(Not Available from O.E.M.)  
Black Nylon

M14 x 34mm  
Bumper and Door Insulator  
Nylon Screw  
No. 3 Square Drive  
Head Outer Diameter: 22mm  
Fits into 12mm Hole  
GM, Ford & Chrysler 2005 - On

UNIT PACKAGE: 25

## HAVE YOU VISITED US ONLINE?

**Auveco's website has been completely renovated.  
Our new design is user friendly with easy navigation and ordering.**

**Product is searchable by car make, OEM number and category, as well as, several attribute drop downs within individual categories. All product also has stock availability listed.**

**Make sure to head over to  
[www.auveco.com](http://www.auveco.com)  
to receive up to date information on all our products.**

**Sec. 5**

**License Plate Screw Specification Chart**



Auveco Part No.	Size	Length	Hex Size	Washer/Head O.D.	Type	Point Type	Finish	Unit Pkg.	Page No.
<b>Machine Screw Thread</b>									
18779	M5-0.8	12mm (15/32")		12.7mm (1/2")	Phillips Pan Washer Head	B	Zinc & Yellow Dichromate	100	107
17315	M6-1.0	12mm (15/32")	10mm	14mm (9/16")	Hex Flange Head	B	Zinc & Clear	50	107
17316	M6-1.0	16mm (5/8")	10mm	14mm (9/16")	Hex Flange Head	B	Zinc & Clear	50	108
14473	M6-1.0	16mm (5/8")		14mm (9/16")	Slotted Round Washer Head	B	Zinc	50	108
17152	M6-1.0	16mm (5/8")		14mm (9/16")	Slotted Round Washer Head	B	Black E-Coat	50	108
20680	M6-1.0	16mm (5/8")		14mm (9/16")	Phillips Round Washer Head	BT	Black Zinc	50	108
21181	M6-1.0	16mm (5/8")		12mm (15/32")	Slotted Pan Head with Hex Nut	B	Black Nylon	50 Sets	110
15413	M6-1.0	20mm (25/32")		12mm (15/32")	Slotted Pan Head with Hex Nut	B	Black Nylon	50 Sets	110
21606	M6-1.0	20mm (25/32")		12mm (15/32")	Phillips Pan Head with Hex Nut	B	Black Nylon	50 Sets	111
13934	M6-1.0	20mm (25/32")		12mm (15/32")	Slotted Pan Head with Hex Nut	B	Natural Nylon	25 Sets	111
18769	M6-1.0	20mm (25/32")		12mm (15/32")	Phillips Pan Head	B	Black E-Coat	50	108
16826	M6-1.0	20mm (25/32")	10mm	13mm (1/2")	Slotted Hex Washer Head	CA	Zinc	50	108
18239	M6-1.0	25mm (1")		12mm (15/32")	Slotted Pan Head with Hex Nut	B	Natural Nylon	25 Sets	111
18241	M6-1.0	25mm (1")		12mm (15/32")	Slotted Pan Head with Hex Nut	B	Black Nylon	25 Sets	111
5908	1/4"-20	1/2"		9/16"	Slotted Round Head	B	Zinc	100	107
5909	1/4"-20	1/2"		1/2"	Slotted Round Washer Head	B	Zinc	100	107
1313	1/4"-20	1/2"		9/16"	Slotted Truss Head with Hex Nut	B	Zinc	100 Sets	107
3184	1/4"-20	1/2"		9/16"	Slotted Truss Head with Square Nut	B	Zinc	100 Sets	109
3182	1/4"-20	1/2"		1/2"	Slotted Round Washer Head with Hex Nut	B	Zinc	100 Sets	109
3183	1/4"-20	1/2"		1/2"	Slotted Round Washer Head with Square Nut	B	Zinc	100 Sets	109
5885	1/4"-20	1/2"		1/2"	Slotted Round Washer Head with Wing Nut	B	Zinc	50 Sets	109
8427	1/4"-20	5/8"		1/2"	Slotted Pan Head with Nylon Nut	F	Zinc	50 Sets	110
13922	1/4"-20	5/8"		19/32"	Slotted Truss Washer Head with Washer Nut	B	Natural Nylon	25 Sets	110

(Continued on next page)



# License Plate Screw Specification Chart

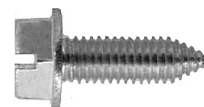

Auveco Part No.	Size	Length	Hex Size	Washer/ Head O.D.	Type	Point Type	Finish	Unit Pkg.	Page No.
<b>Machine Screw Thread (continued)</b>									
18484	1/4"-20	5/8"		19/32"	Slotted Truss Washer Head with Washer Nut	B	Black Nylon	25 Sets	110
5910	1/4"-20	3/4"		9/16"	Slotted Truss Head	B	Zinc	100	108
2472	1/4"-20	3/4"		9/16"	Slotted Round Washer Head with Square Nut	B	Zinc	100 Sets	110
<b>Tapping Screw Thread</b>									
18156	M4.8-1.59 (#10)	16mm (5/8")		10mm (3/8")	Phillips Wafer Head	AB	Zinc & Yellow	50	107
5278	#10	5/8"		1/2"	Slotted Truss Washer Head	AB	Zinc	100	107
17558	#10	3/4"		15/32"	Phillips Flat Washer Head	AB	Black E-Coat	100	107
17980	M6-1.81 (1/4"-14)	16mm (5/8")	10mm	13mm (1/2")	Phillips Hex Washer Head	AB	Zinc & Yellow Dichromate	50	108
16960	M6-1.81 (1/4"-14)	20mm (25/32")	10mm	12mm (15/32")	Phillips Hex Washer Head	AB	Zinc & Yellow Dichromate	50	109
17098	M6.3-1.81 (1/4"-14)	15mm (19/32")		13mm (1/2")	Phillips Truss Head	AB	Zinc & Yellow Dichromate	50	107
19777	M6.3-1.81 (#14)	16mm (5/8")		14mm (9/16")	Duo-Drive Truss Head	B	Dacromet 320	50	108
21081	M6.3-1.81 (#14)	20mm (25/32")		14mm (9/16")	Duo-Drive Truss Head	AB	Dacromet 320	50	109
15170	#14	1/2"			Thumb Screw	AB	Zinc Die Cast	25	109
15758	#14	5/8"		9/16"	Slotted Truss Head	Dog Pt	Zinc	50	107
8249	1/4"	5/8"		9/16"	Slotted Round Washer Head	B	Zinc	100	107
8250	1/4"	5/8"		9/16"	Slotted Round Washer Head with Nylon Nut	B	Zinc	25 Sets	109
16421	#14 (1/4")	5/8"	5/16"	5/8"	Slotted Hex Washer Head	B	Black E-Coat	50	107
16422	#14 (1/4")	5/8"	5/16"	5/8"	Slotted Hex Washer Head	B	Zinc	50	107
20446	#14 (1/4")	5/8"	5/16"	5/8"	Slotted Hex Washer Head	AB	Black E-Coat	50	108
21609	#14	3/4"		15/32"	Phillips Pan Head	A	Stainless Steel	100	108
9603	#14	3/4"		9/16"	Slotted Truss Head	AB	Zinc	100	108
16323	#14	3/4"		9/16"	Slotted Truss Head	AB	Black E-Coat	100	108
11369	#14	3/4"	3/8"	1/2"	Slotted Hex Washer Head	AB	Zinc	50	109
11370	#14	3/4"	3/8"	1/2"	Slotted Hex Washer Head with Nylon Nut	AB	Zinc	25 Sets	110
18354	#14	3/4"	3/8"	1/2"	Slotted Hex Washer Head	AB	Black E-Coat	50	109
20301	#14	1-3/16"		9/16"	Slotted Truss Head	B	Black E-Coat	50	109

**Sec. 5**

**LICENSE PLATE FASTENERS**



**18156**

(51-81-1-821-830)  
Zinc & Yellow

M4.8-1.59 x 16mm (#10 x 5/8")  
Phillips Wafer Head License Plate Screw  
Head O.D.: 10mm (3/8")  
BMW

UNIT PACKAGE: 50



**5909**

Zinc

1/4"-20 x 1/2"  
Slotted Round Washer Head  
License Plate Screw  
Washer Head O.D.: 1/2"

UNIT PACKAGE: 100



**5278**

(3783002)  
Zinc

#10 x 5/8"  
Slotted Truss Washer Head License Plate Screw  
Washer Head O.D.: 1/2"  
**Use with Auveco Nut 5228**  
GM

UNIT PACKAGE: 100



**17098**

Zinc & Yellow Dichromate

M6.3-1.81 x 15mm (1/4"-14 x 19/32")  
Phillips Truss Head License Plate Screw  
Head Diameter: 13mm (1/2")

UNIT PACKAGE: 50



**17558**

Black E-Coat (168 Hours Salt Spray)

#10 x 3/4"  
Phillips Flat Washer Head License Plate Screw  
Washer Head O.D.: 15/32"

UNIT PACKAGE: 100



**15758**

Zinc

#14 x 5/8"  
Slotted Truss Head with Dog Point  
License Plate Screw  
Head O.D.: 9/16"

UNIT PACKAGE: 50



**18779**

Zinc & Yellow Dichromate

M5-0.8 x 12mm  
Phillips Pan Washer Head License Plate Screw  
Washer Head O.D.: 12.7mm (1/2")  
Ford Contour & Mercury Mystique 1995-On

UNIT PACKAGE: 100



**8249**

Zinc

1/4" x 5/8"  
Slotted Round Washer Head  
License Plate Screw  
Washer Head O.D.: 9/16"  
**Use with Auveco Nut 8242**

UNIT PACKAGE: 100



**17315**

Zinc & Clear

M6-1.0 x 12mm  
Hex Flange License Plate Screw  
Flange O.D.: 14mm (9/16")  
Hex: 10mm  
Class 10.9  
Acura

UNIT PACKAGE: 50



**16421**

(N800369-S2)  
Black E-Coat

#14 (1/4") x 5/8"  
Slotted Hex Washer Head License Plate Screw  
Washer Head O.D.: 5/8"  
Hex: 5/16"  
Ford

UNIT PACKAGE: 50

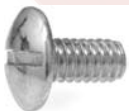

**5908**

Zinc

1/4"-20 x 1/2"  
Slotted Round Head License Plate Screw  
Head Diameter: 9/16"

UNIT PACKAGE: 100



**16422**

(N800369)  
Zinc

#14 (1/4") x 5/8"  
Slotted Hex Washer Head License Plate Screw  
Washer Head O.D.: 5/8"  
Hex: 5/16"  
Ford

UNIT PACKAGE: 50

# LICENSE PLATE FASTENERS

## Sec. 5



**20446**  
Black E-Coat  
#14 (1/4") x 5/8"  
Slotted Hex Washer Head  
License Plate Screw  
Washer Head O.D.: 5/8"  
Hex: 5/16"  
Ford

UNIT PACKAGE: 50



**17980**  
Zinc & Yellow Dichromate  
M6-1.81 x 16mm (1/4"-14 x 5/8")  
Phillips Hex Washer Head License Plate Screw  
Washer Head O.D.: 13mm (1/2")  
Hex: 10mm

UNIT PACKAGE: 50



**17316**  
Zinc & Clear  
M6-1.0 x 16mm  
Hex Flange License Plate Screw  
Flange O.D.: 14mm (9/16")  
Hex: 10mm  
Class 10.9  
Acura

UNIT PACKAGE: 50



**14473**  
Zinc  
M6-1.0 x 16mm  
Slotted Round Washer Head  
License Plate Screw  
Washer Head O.D.: 14mm (9/16")

UNIT PACKAGE: 50



**17152**  
Black E-Coat (168 Hours Salt Spray)  
M6-1.0 x 16mm  
Slotted Round Washer Head  
License Plate Screw  
Washer Head O.D.: 14mm (9/16")

UNIT PACKAGE: 50



**20680**  
Black Zinc  
M6-1.0 x 16mm  
Phillips Round Washer Head Thread Cutting  
License Plate Screw  
Washer Head O.D.: 14mm (9/16")  
Hyundai

UNIT PACKAGE: 50



**19777**  
Dacromet 320  
M6.3-1.81 x 16mm (#14 x 5/8")  
Duo-Drive Truss Head License Plate Screw  
Head Diameter: 14mm  
GM

UNIT PACKAGE: 50



**21609**  
Stainless Steel  
#14 x 3/4"  
Phillips Pan Head License Plate Screw  
Head O.D.: 15/32"

UNIT PACKAGE: 100



**5910**  
Zinc  
1/4"-20 x 3/4"  
Slotted Truss Head License Plate Screw  
Head Diameter: 9/16"

UNIT PACKAGE: 100



**9603**  
Zinc  
#14 x 3/4"  
Slotted Truss Head License Plate Screw  
Head Diameter: 9/16"

UNIT PACKAGE: 100



**16323**  
Black E-Coat (168 Hours Salt Spray)  
#14 x 3/4"  
Slotted Truss Head License Plate Screw  
Head Diameter: 9/16"

UNIT PACKAGE: 100



**18769**  
Black E-Coat  
(168 Hours Salt Spray)  
M6-1.0 x 20mm  
Phillips Pan Head License Plate Screw  
Head Diameter: 12mm (15/32")

UNIT PACKAGE: 50

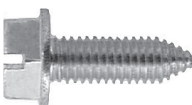

**16826**  
(Chry: 34201287;  
AMC: 8934201287)  
Zinc  
M6-1.0 x 20mm  
Slotted Hex Washer Head License Plate Screw  
Washer Head O.D.: 13mm (1/2")  
Hex: 10mm  
Chrysler, Honda & AMC

UNIT PACKAGE: 50



**Sec. 5**

**LICENSE PLATE FASTENERS**



**16960**

(Toyota: 93904-46320;  
Honda: 91500-SM4-999AH)  
Zinc & Yellow Dichromate

M6-1.81 x 20mm (1/4" - 14 x 3/4")  
Phillips Hex Washer Head License Plate Screw  
Washer Head O.D.: 12mm (1/2")  
Hex: 10mm  
Honda, GEO Prizm & Toyota 1990-On

UNIT PACKAGE: 50



**11369**

Zinc

#14 x 3/4"

Slotted Hex Washer Head License Plate Screw  
Washer Head O.D.: 1/2"  
Hex: 3/8"  
Ford

UNIT PACKAGE: 50



**18354**

Black E-Coat  
(168 Hours Salt Spray)

#14 x 3/4"

Slotted Hex Washer Head License Plate Screw  
Washer Head O.D.: 1/2"  
Hex: 3/8"  
Ford

UNIT PACKAGE: 50



**21081**

(25732397)  
Dacromet 320

M6.3-1.81 x 20mm  
(#14 x 3/4")

Duo-Drive Truss Head License Plate Screw  
Head Diameter: 14mm  
GM 2002 - On

UNIT PACKAGE: 50



**20301**

(16502342)  
Black E-Coat  
(168 Hours Salt Spray)

#14 x 1-3/16"

Slotted Truss Head License Plate Screw  
Head Diameter: 9/16"  
GM S & T Trucks 1998 - On

UNIT PACKAGE: 50



**15170**

#14 x 1/2"  
Dealer License  
Plate Thumb Screw  
Overall Length: 1-1/8"

UNIT PACKAGE: 25



**1313**

Zinc

1/4"-20 x 1/2"

Slotted Truss Head  
License Plate Screw with Hex Nut  
Head Diameter: 9/16"  
Hex Width (ATF): 7/16"

UNIT PACKAGE: 100 Sets



**3184**

Zinc

1/4"-20 x 1/2"

Slotted Truss Head  
License Plate Screw with Square Nut  
Head Diameter: 9/16"  
ATF: 7/16"

UNIT PACKAGE: 100 Sets



**3182**

Zinc

1/4"-20 x 1/2"

Slotted Round Washer Head  
License Plate Screw with Hex Nut  
Washer Head O.D.: 1/2"  
Hex Width (ATF): 7/16"

UNIT PACKAGE: 100 Sets



**3183**

Zinc

1/4"-20 x 1/2"

Slotted Round Washer Head  
License Plate Screw  
with Square Nut  
Washer Head O.D.: 1/2"  
ATF: 7/16"

UNIT PACKAGE: 100 Sets



**5885**

Zinc

1/4"-20 x 1/2"

Slotted Round Washer Head  
License Plate Screw with Flat Washer  
and Wing Nut  
Washer Head O.D.: 1/2"  
Washer O.D.: 5/8"

UNIT PACKAGE: 50 Sets



**8250**

Zinc

1/4" x 5/8"

Slotted Round Washer Head  
License Plate Screw and Nylon  
Nut (Auveco No. 8249 & 8242)  
Washer Head O.D.: 9/16"  
Chrysler

UNIT PACKAGE: 25 Sets

# LICENSE PLATE FASTENERS

## Sec. 5



**8427**  
(379046-S)  
Zinc

1/4"-20 x 5/8"  
Slotted Pan Head Type F Thread Cutting  
License Plate Screw and  
Nylon Nut (Auveco 5307 & 3682)  
Head Diameter: 1/2"

UNIT PACKAGE: 50 Sets



**2472**  
Zinc

1/4"-20 x 3/4"  
Slotted Truss Head  
License Plate Screw with Square Nut  
Head Diameter: 9/16"  
Hex Width (ATF): 7/16"

UNIT PACKAGE: 100 Sets



**11370**  
Zinc

#14 x 3/4"  
Slotted Hex Washer Head  
License Plate Screw and  
Nylon Nut (Auveco 11368 & 11369)  
Washer Head O.D.: 1/2"  
Hex: 3/8"  
Ford

UNIT PACKAGE: 25 Sets



**13922**  
Natural Nylon

1/4"-20 x 5/8"  
Slotted Truss Washer Head  
Washer Head O.D.: 19/32"  
Washer Nut O.D.: 9/16"  
Hex Width (ATF): 7/16"

UNIT PACKAGE: 25 Sets

**17171**  
Screw only from 13922  
UNIT PACKAGE: 50

**18342**  
Screw only from 13922  
UNIT PACKAGE: 1000

**17228**  
Nut only from 13922  
UNIT PACKAGE: 50

**18346**  
Nut only from 13922  
UNIT PACKAGE: 1000



**18484**  
Black Nylon

1/4"-20 x 5/8"  
Slotted Truss Washer Head  
Washer Head O.D.: 19/32"  
Washer Nut O.D.: 9/16"  
Hex Width (ATF): 7/16"

UNIT PACKAGE: 25 Sets

**18485**  
Screw only from 18484  
UNIT PACKAGE: 50

**18486**  
Screw only from 18484  
UNIT PACKAGE: 1000

**18487**  
Nut only from 18484  
UNIT PACKAGE: 50

**18488**  
Nut only from 18484  
UNIT PACKAGE: 1000



**21181**  
Black Nylon

M6-1.0 x 16mm  
Slotted Pan Head  
Head Diameter: 12mm (15/32")  
Hex Width (ATF): 10mm (25/64")

UNIT PACKAGE: 50 Sets

**21182**  
Screw only from 21181  
UNIT PACKAGE: 100

**21183**  
Screw only from 21181  
UNIT PACKAGE: 1000

**18348**  
Nut only from 21181  
UNIT PACKAGE: 1000



**15413**  
Black Nylon

M6-1.0 x 20mm  
Slotted Pan Head  
Head Diameter: 12mm (15/32")  
Hex Width (ATF): 10mm (25/64")

UNIT PACKAGE: 50 Sets

**17091**  
Screw only from 15413  
UNIT PACKAGE: 100

**18344**  
Screw only from 15413  
UNIT PACKAGE: 1000

**18348**  
Nut only from 15413  
UNIT PACKAGE: 1000

**Sec. 5**

**LICENSE PLATE FASTENERS**



**13934**

Natural Nylon

M6-1.0 x 20mm  
Slotted Pan Head  
Head Diameter: 12mm (15/32")  
Hex Width (ATF): 10mm (25/64")

UNIT PACKAGE: 25 Sets

**17169**

Screw only from 13934  
UNIT PACKAGE: 100

**18343**

Screw only from 13934  
UNIT PACKAGE: 1000

**18347**

Nut only from 13934  
UNIT PACKAGE: 1000



**21606**

Black Nylon

M6-1.0 x 20mm  
Phillips Pan Head  
Head Diameter: 12mm (15/32")  
Hex Width (ATF): 10mm (25/64")

UNIT PACKAGE: 50 Sets

**21607**

Screw only from 21606  
UNIT PACKAGE: 100

**21608**

Screw only from 21606  
UNIT PACKAGE: 1000

**18348**

Nut only from 21606  
UNIT PACKAGE: 1000



**18239**

Natural Nylon

M6-1.0 x 25mm  
Slotted Pan Head  
Head Diameter: 12mm (15/32")  
Hex Width (ATF): 10mm (25/64")

UNIT PACKAGE: 25 Sets

**18238**

Screw only from 18239  
UNIT PACKAGE: 50



**18241**

Black Nylon

M6-1.0 x 25mm  
Slotted Pan Head  
Head Diameter: 12mm (15/32")  
Hex Width (ATF): 10mm (25/64")

UNIT PACKAGE: 25 Sets

**18240**

Screw only from 18241  
UNIT PACKAGE: 50



**16669**

Bagged Hardware

2 Pieces each of 9603  
(Slotted Truss  
Head Screw: #14 x 3/4")  
And 11719 (Nylon Nut)  
Packaged in unmarked,  
see-thru plastic bags.

UNIT PACKAGE: 50 Sets



**16670**

Bagged Hardware

4 Pieces each of 9603  
(Slotted Truss  
Head Screw: #14 x 3/4")  
And 11719 (Nylon Nut)  
Packaged in unmarked,  
see-thru plastic bags.

UNIT PACKAGE: 50 Sets

**16690**

Same as 16670 except for unit package quantity

UNIT PACKAGE: 100 Sets



**16800**

Nylon Screw, Spacer,  
Washer & Brass Nut

M6-1.0 x 20mm  
Slotted Pan Head License  
Plate Screw & Hardware  
Head Diameter: 12mm (15/32")  
Hex Width (ATF): 10mm (25/64")  
Washer O.D.: 12.5mm (1/2")  
Spacer O.D.: 19mm (3/4")  
Toyota

UNIT PACKAGE: 25 Sets



**17636**

Nylon

License Plate Bracket Spacer  
I.D.: 1/4" (6mm)  
O.D.: 3/4" (19mm)  
Thickness: 1/4" (6mm)  
Toyota

UNIT PACKAGE: 50



**2625**

Nylon

License Plate Nut & Headlight Door Screw  
Screw Size: #8  
Mounting Screw Nut  
Chrysler

UNIT PACKAGE: 100



# LICENSE PLATE FASTENERS

## Sec. 5



**5228**  
(3783006)  
Nylon

License Plate Nut  
Screw Size: #10  
**Use with Auveco Screw 5278**  
GM

UNIT PACKAGE: 50



**20927**  
(N811478-S100)  
Black Nylon

License Plate & Rear Bumper  
Nylon Nut with Sealer  
Screw Size: M6.3 (#14)  
Head Size: 16mm x 16mm  
Stem Length: 8mm  
Ford Fusion & Mustang 2005 - On

UNIT PACKAGE: 15



**13466**  
(6032516)  
Black Nylon

License Plate Nut  
Screw Size: #12  
Chrysler

UNIT PACKAGE: 25



**11368**  
(380707-S)  
Nylon

License Plate Nut  
Screw Size: #14  
Ford

UNIT PACKAGE: 50

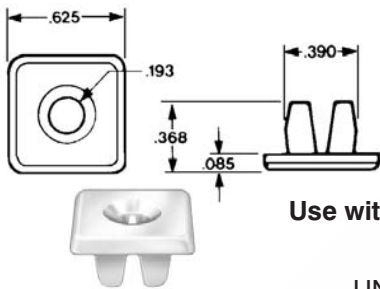

**3682**  
(1196781)  
Nylon

License Plate Nut  
Screw Size: 1/4" -20  
**Use with Auveco Screw 5307**  
GM

UNIT PACKAGE: 50



**8242**  
(6023925)  
Nylon

License Plate Nut  
Screw Size: 1/4" (#14)  
**Use with Auveco Screw 8249**  
Chrysler

UNIT PACKAGE: 50

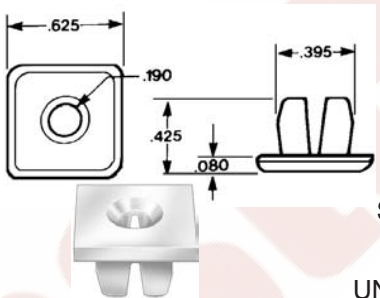

**8435**  
(4755299)  
Nylon

License Plate Nut  
Screw Size: 1/4" (#14)  
GM

UNIT PACKAGE: 50



**8418**  
(380370)  
Nylon

License Plate Nut  
Screw Size: #14  
**Use with Auveco Screw 3089**  
GM

UNIT PACKAGE: 50



**8954**  
Nylon

License Plate Nut  
Screw Size: #14  
**Use with Auveco Screws 8249 or 8952**

UNIT PACKAGE: 50

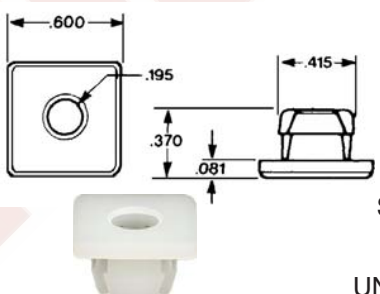

**11719**  
(3907444)  
Nylon

License Plate Nut  
Screw Size: 1/4" (#14)  
GM

UNIT PACKAGE: 50



**19485**  
(6027958)  
Natural Nylon

License Plate Nut  
Screw Size: 1/4" (#14)  
Chrysler

UNIT PACKAGE: 10

**Sec. 5**

**LICENSE PLATE FASTENERS**



**20937**  
(22546934)  
Black Nylon

License Plate Screw Grommet  
Screw Size: M6.3 (#14)  
Head Size: 20mm x 20mm  
Stem Length: 14mm  
Buick Skylark, Chevrolet, Malibu,  
Oldsmobile Achieva, Cutlass  
& Intrigue 1992 - On

UNIT PACKAGE: 50



**19317**  
(15707256)  
Zinc Organic

Front Fender Extension  
& License Plate Bracket  
Retainer Nut  
Screw Size: M6-1.0  
GM Express &  
Savanna 1996-On

UNIT PACKAGE: 10

# AN IMPROVED FASTRACK WEB

FasTrack is an easy-to-use, web based system designed to assist body shops and dealerships in recovering the cost of body repair clips and fasteners used in daily collision repairs.

## Features:

- **New Look:** User-friendly design and intuitive functions with over 10,000 collision repair fasteners by Auveco
- **Repair Kits:** Simple to build your own kits or choose one of the other preloaded kits
- **Add Part Numbers with Ease:** Add unique non-auveco items. Add new numbers on the fly during invoicing
- **OEM Numbers:** Available with the latest OEM pricing and ability to use during invoicing
- **Reports:** Page by page user selected printing to gather usage information
- **Inventory Management:** Allows shop and/or the distributor to track inventory
- **Labeling:** End user can print individual bar code labels and lid labels
- **Barcode Scanning:** Done with our app using any smart phone or with our wedge scanner
- **Online Catalog & OEM Crossover**
- **Repair Type:** Requested by many insurance companies you can now add Repair Type during invoice processing (Front Bumper, Front Fender, Door, etc.)
- **CCC® Integration:** Enables users to import FasTrack invoices into CCC's Estimating system
- **Tutorial Videos:** Found in the Help Menu, videos demonstrating all FasTrack features
- **Security:** Site protected by Verisign Internet Security.

*Questions or concerns.*

*Call 1-800-354-9816 or email [fastrack.support@auveco.com](mailto:fastrack.support@auveco.com)*

# CYLINDER HEAD AND MANIFOLD STUDS

## Grade 8 Medium Carbon Heat Treated Alloy Steel

### Sec. 6

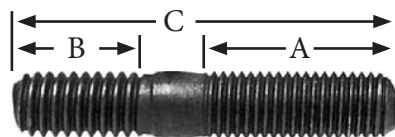

Auveco Part No.	A Diameter & Length	B Diameter & Length	C Overall Length	Unit Pkg.
19595•	1/4"-20 USS x 1/2"	1/4"-20 USS x 8"	9"	10
9667	1/4"-28 SAE x 3/8"	1/4"-20 USS x 7/16"	1"	10
9668	1/4"-28 SAE x 1/2"	1/4"-20 USS x 1/2"	1-1/4"	10
9669	1/4"-28 SAE x 3/4"	1/4"-20 USS x 1/2"	1-1/2"	10
9670	1/4"-28 SAE x 1"	1/4"-20 USS x 1/2"	2"	10
9673	5/16"-24 SAE x 7/16"	5/16"-18 USS x 3/8"	1"	10
9674	5/16"-24 SAE x 5/8"	5/16"-18 USS x 1/2"	1-1/4"	10
9675	5/16"-24 SAE x 5/8"	5/16"-18 USS x 3/4"	1-1/2"	10
9676	5/16"-24 SAE x 7/8"	5/16"-18 USS x 9/16"	1-3/4"	10
9677	5/16"-24 SAE x 1"	5/16"-18 USS x 9/16"	2"	10
14824	5/16"-24 SAE x 1-5/8"	5/16"-18 USS x 1/2"	2-1/2"	10
9679	5/16"-18 USS x 7/8"	5/16"-18 USS x 7/16"	1-1/2"	10
9680	5/16"-18 USS x 1"	5/16"-18 USS x 7/16"	2"	10
9681	5/16"-24 SAE x 1-1/2"	5/16"-18 USS x 5/8"	3"	10
9683	3/8"-24 SAE x 3/4"	3/8"-16 USS x 1/2"	1-1/2"	10
9684	3/8"-24 SAE x 3/4"	3/8"-16 USS x 1/2"	1-3/4"	10
9686	3/8"-24 SAE x 1"	3/8"-16 USS x 5/8"	2"	10
9687	3/8"-16 USS x 1"	3/8"-16 USS x 3/4"	2"	10
9688	3/8"-16 USS x 1"	3/8"-16 USS x 5/8"	2-1/8"	10
14827*	3/8"-16 USS x 1-5/8"	3/8"-16 USS x 7/16"	2-7/32"	10
19597*	3/8"-16 USS x 1/2"	3/8"-16 USS x 1-7/8"	2-1/2"	10
9689	3/8"-24 SAE x 1"	3/8"-16 USS x 3/4"	2-3/4"	10
12129	3/8"-16 USS x 5/8"	3/8"-16 USS x 2"	3"	10
9690	3/8"-24 SAE x 2"	3/8"-16 USS x 5/8"	3"	10
9692	3/8"-16 USS x 1-5/8"	3/8"-16 USS x 7/16"	3-1/4"	10
9695	3/8"-16 USS x 2"	3/8"-16 USS x 3/4"	4"	10
9696	3/8"-24 SAE x 1-7/8"	3/8"-16 USS x 1/2"	4"	10
9699	7/16"-20 SAE x 3/4"	7/16"-14 USS x 9/16"	1-3/4"	10
9701	7/16"-20 SAE x 7/8"	7/16"-14 USS x 3/4"	2"	10
9702	7/16"-14 USS x 15/16"	7/16"-14 USS x 3/4"	2"	10
9705	7/16"-20 SAE x 3/4"	7/16"-14 USS x 3/4"	2-1/4"	10
9709	7/16"-20 SAE x 7/8"	7/16"-14 USS x 3/4"	2-1/2"	10
9711	7/16"-14 USS x 1-1/4"	7/16"-14 USS x 3/4"	2-1/2"	10
9712	7/16"-20 SAE x 1-3/8"	7/16"-14 USS x 3/4"	2-1/2"	10
9715	7/16"-20 SAE x 1-13/16"	7/16"-14 USS x 3/4"	3"	10
9727	1/2"-20 SAE x 3/4"	1/2"-13 USS x 3/4"	1-7/8"	10
9728	1/2"-20 SAE x 15/16"	1/2"-13 USS x 13/16"	2"	10
9729	1/2"-20 SAE x 1"	1/2"-13 USS x 3/4"	2-1/4"	10
9731	1/2"-20 SAE x 1"	1/2"-13 USS x 3/4"	2-1/2"	10
9732	1/2"-20 SAE x 2"	1/2"-13 USS x 3/4"	3"	10
9739	9/16"-18 SAE x 1-1/4"	9/16"-12 USS x 1"	3"	10
9744	5/8"-11 USS x 1-1/2"	5/8"-11 USS x 13/16"	2-3/4"	10
9745	5/8"-18 SAE x 1-1/4"	5/8"-11 USS x 1"	3"	10

•Grade 2, Zinc Plated

\* With Dog Point



**Sec. 6**

**CYLINDER HEAD AND MANIFOLD STUDS**

Grade 8 Medium Carbon Heat Treated Alloy Steel

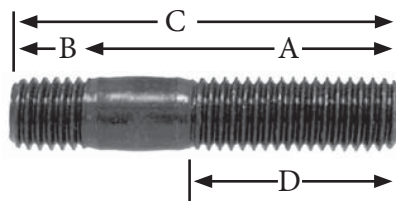

Auveco Part No.	A Diameter & Length	B Diameter & Length	C Overall Length	D Length	Unit Pkg.
11973	6mm-1.00 x 20mm	6mm-1.00 x 7.5mm	27.5mm	18mm	10
11974	6mm-1.00 x 25mm	6mm-1.00 x 7.5mm	32.5mm	18mm	10
11980	8mm-1.25 x 20mm	8mm-1.25 x 10mm	30.0mm	16mm	10
11981	8mm-1.25 x 25mm	8mm-1.25 x 10mm	35.0mm	22mm	10
11982	8mm-1.25 x 30mm	8mm-1.25 x 10mm	40.0mm	22mm	10
11983	8mm-1.25 x 35mm	8mm-1.25 x 10mm	45.0mm	22mm	10
11984	8mm-1.25 x 40mm	8mm-1.25 x 10mm	50.0mm	22mm	10
11987	8mm-1.25 x 55mm	8mm-1.25 x 10mm	65.0mm	22mm	10
11989	10mm-1.50 x 30mm	10mm-1.50 x 12mm	42.0mm	18mm	10
11990	10mm-1.50 x 35mm	10mm-1.50 x 12mm	47.0mm	26mm	10
11991	10mm-1.50 x 40mm	10mm-1.50 x 12mm	52.0mm	26mm	10
11993	10mm-1.50 x 50mm	10mm-1.50 x 12mm	62.0mm	26mm	10
11995	10mm-1.50 x 65mm	10mm-1.50 x 12mm	77.0mm	26mm	5
11998	12mm-1.75 x 30mm	12mm-1.75 x 15mm	45.0mm	25mm	5



**11404**

(N14-4003)  
Plain

M8-1.25 x 35mm  
Class 4.8  
Volkswagen Intake Manifold

UNIT PACKAGE: 25

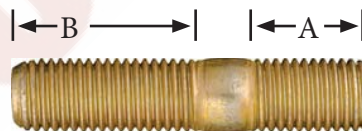

**17560**

Zinc & Yellow Dichromate

M10-1.25 x 48mm  
Dim. A: 15mm; Dim. B: 25mm  
Class 8.8

Exhaust Systems  
Honda, Nissan & Toyota

UNIT PACKAGE: 10



**17559**

Zinc & Yellow Dichromate

M10-1.25 x 42mm  
Class 8.8  
Exhaust Systems  
Honda, Nissan & Toyota

UNIT PACKAGE: 10



**17596**

Zinc & Yellow Dichromate

M12-1.25 x 50mm  
Class 8.8  
Catalytic Converter  
Mazda

UNIT PACKAGE: 5

**METRIC ITEMS**



**Phillips Pan Head  
Metric Machine Screws  
DIN 7985  
Regular Pitch • Zinc Plated**

Auveco Part No.	Diameter & Pitch	Length	Unit Pkg.
15867	4mm-.70	8mm	100
15868	4mm-.70	10mm	100
15869	4mm-.70	16mm	100
15870	5mm-.80	8mm	100
15871	5mm-.80	10mm	100
15872	5mm-.80	12mm	100
15873	5mm-.80	16mm	100
15874	5mm-.80	20mm	100
15875	5mm-.80	25mm	100
15876	6mm-1.00	10mm	100
15877	6mm-1.00	12mm	100
15878	6mm-1.00	16mm	50
15879	6mm-1.00	20mm	50
15880	6mm-1.00	25mm	50
15881	6mm-1.00	30mm	50



**Slotted Pan Head  
Metric Machine Screws  
DIN 85  
Regular Pitch • Zinc Plated**

Auveco Part No.	Diameter & Pitch	Length	Unit Pkg.
10427	4mm-.70	10mm	25
10431	5mm-.80	12mm	25
10436	6mm-1.00	10mm	25
14391	6mm-1.00	10mm	100
10437	6mm-1.00	12mm	25
14392	6mm-1.00	12mm	100
10438	6mm-1.00	16mm	25
14393	6mm-1.00	16mm	100
10439	6mm-1.00	18mm	25
14394	6mm-1.00	18mm	100
10440	6mm-1.00	20mm	25
14395	6mm-1.00	20mm	100
10441	6mm-1.00	25mm	25



**Slotted Flat Fillister Head  
Metric Machine Screws  
DIN 84  
Regular Pitch • Zinc Plated**

Auveco Part No.	Diameter & Pitch	Length	Unit Pkg.
10459	5mm-.80	16mm	25
10460	5mm-.80	20mm	25
14396	6mm-1.00	10mm	100
10464	6mm-1.00	20mm	25
14398	6mm-1.00	20mm	50



**Phillips Oval Head  
Metric Machine Screws  
DIN 966  
Regular Pitch • Zinc Plated**

Auveco Part No.	Diameter & Pitch	Length	Unit Pkg.
15888	5mm-.80	12mm	100
15890	5mm-.80	20mm	100
15893	6mm-1.00	12mm	100
15895	6mm-1.00	20mm	50
15896	6mm-1.00	25mm	50



**Slotted Flat Head Metric Machine Screws  
DIN 963 (Medium Head)  
Regular Pitch • Zinc Plated**

Auveco Part No.	Diameter & Pitch	Length	Unit Pkg.
10478	4mm-.70	8mm	25

Auveco Part No.	Diameter & Pitch	Length	Unit Pkg.
10488	6mm-1.00	25mm	25

**Sec. 7**

**METRIC ITEMS**



**Regular Pitch Metric Hex Head Cap Screws**

DIN 931 & DIN 933

Fully Threaded • 8.8 Heat Treated Alloy Steel • Zinc Plated  
Tensile Strength: 116,000 PSI

Auveco Part No.	Diameter & Pitch	Length	Unit Pkg.
<b>4mm (7mm Hex)</b>			
14581	4mm-.7	12mm	50
10501	4mm-.7	16mm	25
14400	4mm-.7	16mm	50
10502	4mm-.7	20mm	25
14401	4mm-.7	20mm	50
14582	4mm-.7	25mm	50
<b>5mm (8mm Hex)</b>			
10504	5mm-.8	10mm	25
14402	5mm-.8	10mm	50
14583	5mm-.8	12mm	50
10505	5mm-.8	16mm	25
14403	5mm-.8	16mm	50
10506	5mm-.8	20mm	25
14404	5mm-.8	20mm	50
10507	5mm-.8	25mm	25
14405	5mm-.8	25mm	50
10508	5mm-.8	30mm	10
14406	5mm-.8	30mm	25
15512	5mm-.8	40mm	50
<b>6mm (10mm Hex)</b>			
14584	6mm-1.00	10mm	50
10509	6mm-1.00	12mm	25
14407	6mm-1.00	12mm	50
16697	6mm-1.00	12mm	100
10510	6mm-1.00	16mm	10
14408	6mm-1.00	16mm	25
16698	6mm-1.00	16mm	100
10511	6mm-1.00	20mm	10
14409	6mm-1.00	20mm	25
16699	6mm-1.00	20mm	100
10512	6mm-1.00	25mm	10
14410	6mm-1.00	25mm	25
16700	6mm-1.00	25mm	100
10513*	6mm-1.00	30mm	10
14411*	6mm-1.00	30mm	25
16701*	6mm-1.00	30mm	100
10514*	6mm-1.00	35mm	10
14412*	6mm-1.00	35mm	25
10515*	6mm-1.00	40mm	10
14413*	6mm-1.00	40mm	25
10516*	6mm-1.00	45mm	10
14414*	6mm-1.00	45mm	25
14585*	6mm-1.00	50mm	25
15514*	6mm-1.00	60mm	25
<b>7mm(11mm Hex)</b>			
14586	7mm-1.00	12mm	25
10517	7mm-1.00	16mm	10
14415	7mm-1.00	16mm	25
10519	7mm-1.00	25mm	10
14417	7mm-1.00	25mm	25
10520	7mm-1.00	30mm	10
14418	7mm-1.00	30mm	25
14587	7mm-1.00	40mm	25

Auveco Part No.	Diameter & Pitch	Length	Unit Pkg.
<b>8mm (13mm Hex)</b>			
14588	8mm-1.25	12mm	25
10521	8mm-1.25	16mm	10
14419	8mm-1.25	16mm	25
16702	8mm-1.25	16mm	50
10522	8mm-1.25	20mm	10
14420	8mm-1.25	20mm	25
16703	8mm-1.25	20mm	50
10523	8mm-1.25	25mm	10
14421	8mm-1.25	25mm	25
16704	8mm-1.25	25mm	50
10524	8mm-1.25	30mm	10
14422	8mm-1.25	30mm	25
16705	8mm-1.25	30mm	50
10525*	8mm-1.25	35mm	10
14423*	8mm-1.25	35mm	25
16706*	8mm-1.25	35mm	50
10526*	8mm-1.25	40mm	10
14424*	8mm-1.25	40mm	25
16707*	8mm-1.25	40mm	50
10527*	8mm-1.25	45mm	10
14425*	8mm-1.25	45mm	25
10528*	8mm-1.25	50mm	10
14426*	8mm-1.25	50mm	25
10529*	8mm-1.25	55mm	10
14427*	8mm-1.25	55mm	25
10530*	8mm-1.25	60mm	10
14428*	8mm-1.25	60mm	25
10532	8mm-1.25	70mm	5
14429	8mm-1.25	70mm	10
14589*	8mm-1.25	75mm	10
17399*	8mm-1.25	80mm	15
17400*	8mm-1.25	90mm	15
17401*	8mm-1.25	100mm	10
<b>10mm (17mm Hex)</b>			
10534	10mm-1.50	20mm	10
14430	10mm-1.50	20mm	25
16708	10mm-1.50	20mm	50
10535	10mm-1.50	25mm	10
14431	10mm-1.50	25mm	25
16709	10mm-1.50	25mm	50
10536	10mm-1.50	30mm	10
14432	10mm-1.50	30mm	25
16710	10mm-1.50	30mm	50
10537	10mm-1.50	35mm	5
14433	10mm-1.50	35mm	15
16711	10mm-1.50	35mm	25
10538*	10mm-1.50	40mm	5
14434*	10mm-1.50	40mm	15
16712*	10mm-1.50	40mm	25
10539*	10mm-1.50	45mm	5
14435*	10mm-1.50	45mm	15
10540*	10mm-1.50	50mm	5
14436*	10mm-1.50	50mm	15
16713*	10mm-1.50	50mm	25

\*DIN 931 - Not Fully Threaded

(Continued on next page)



**METRIC ITEMS****Sec. 7****Regular Pitch Metric Hex Head Cap Screws**

DIN 931 &amp; DIN 933

Fully Threaded • 8.8 Heat Treated Alloy Steel • Zinc Plated  
Tensile Strength: 116,000 PSI

Auveco Part No.	Diameter & Pitch	Length	Unit Pkg.	Auveco Part No.	Diameter & Pitch	Length	Unit Pkg.
10mm (17mm Hex) Continued				12mm (19mm Hex) Continued			
10541*	10mm-1.50	55mm	5	14444*	12mm-1.75	45mm	10
14437*	10mm-1.50	55mm	10	10549*	12mm-1.75	50mm	5
10542*	10mm-1.50	60mm	5	14445*	12mm-1.75	50mm	10
14438*	10mm-1.50	60mm	10	10550*	12mm-1.75	60mm	5
16714*	10mm-1.50	60mm	25	14446*	12mm-1.75	60mm	10
10543*	10mm-1.50	70mm	5	10551*	12mm-1.75	70mm	5
14439*	10mm-1.50	70mm	10	14447*	12mm-1.75	70mm	10
15515*	10mm-1.50	80mm	10	17403*	12mm-1.75	80mm	10
15516*	10mm-1.50	90mm	10	17404*	12mm-1.75	90mm	10
15517*	10mm-1.50	100mm	10	17405*	12mm-1.75	100mm	5
12mm (19mm Hex)				14mm (22mm Hex)			
10544	12mm-1.75	25mm	5	14590	14mm-2.0	30mm	10
14440	12mm-1.75	25mm	10	14591	14mm-2.0	40mm	10
16715	12mm-1.75	25mm	25	14592	14mm-2.0	50mm	10
10545	12mm-1.75	30mm	5	16mm (24mm Hex)			
14441	12mm-1.75	30mm	10	14595	16mm-2.0	30mm	5
16716	12mm-1.75	30mm	25	14598*	16mm-2.0	60mm	5
10546	12mm-1.75	35mm	5	20mm (30mm Hex)			
14442	12mm-1.75	35mm	10	14602	20mm-2.5	60mm	5
16717	12mm-1.75	35mm	25	*DIN 931 - Not Fully Threaded			
10547	12mm-1.75	40mm	5				
14443	12mm-1.75	40mm	10				
16718	12mm-1.75	40mm	25				
10548*	12mm-1.75	45mm	5				

**J.I.S Small Head Cap Screws**

J.I.S. B 1180 • I.S.O. Class 8.8

Heat Treated • Steel • Zinc Plated



J.I.S. fasteners have a smaller hex dimension (across the flats) than DIN or ISO metric fasteners. They fit in those tight spots where the hex of an ISO or DIN fastener is too large. J.I.S. fasteners are OEM equipment on many GM and Japanese import car applications.

Auveco Part No.	Diameter & Pitch	Length	Unit Pkg.	Auveco Part No.	Diameter & Pitch	Length	Unit Pkg.
M8-1.25 (12mm Hex)				M12-1.25 (17mm Hex)			
14777	8mm-1.25	16mm	25	16609	12mm-1.25	20mm	10
14778	8mm-1.25	20mm	25	16610	12mm-1.25	25mm	10
14779	8mm-1.25	25mm	25	16611	12mm-1.25	30mm	10
14780	8mm-1.25	30mm	25	16612	12mm-1.25	35mm	10
14781	8mm-1.25	35mm	25	16613	12mm-1.25	40mm	10
14782	8mm-1.25	40mm	25	16614	12mm-1.25	50mm	10
14784	8mm-1.25	50mm	25				
M10-1.25 (14mm Hex)							
14787	10mm-1.25	20mm	25				
14788	10mm-1.25	25mm	25				
14789	10mm-1.25	30mm	25				
14790	10mm-1.25	35mm	15				
14791	10mm-1.25	40mm	15				
14792	10mm-1.25	45mm	15				
14793	10mm-1.25	50mm	15				
14794	10mm-1.25	60mm	10				

**Sec. 7**

**METRIC ITEMS**



**Fine Pitch Metric Hex Head Cap Screws**  
DIN 960 & DIN 961

Fully Threaded  
8.8 Heat Treated Alloy Steel • Black Finish  
Tensile Strength: 116,000 PSI

Auveco Part No.	Diameter & Pitch	Length	Unit Pkg.
8mm (13mm Hex)			
11255	8mm-1.00	10mm	10
11257	8mm-1.00	25mm	10
11259	8mm-1.00	40mm	10
14604*	8mm-1.00	50mm	25
10mm (17mm Hex)			
11262	10mm-1.00	30mm	10
11263	10mm-1.00	40mm	10
11264	10mm-1.00	50mm	10
14605	10mm-1.25	20mm	10
11265	10mm-1.25	25mm	10
11266	10mm-1.25	30mm	10
11267	10mm-1.25	35mm	10
11268	10mm-1.25	40mm	10
11269	10mm-1.25	50mm	10
14606*	10mm-1.25	60mm	10
12mm (19mm Hex)			
11270	12mm-1.25	25mm	10
14607	12mm-1.25	30mm	5
11271	12mm-1.25	35mm	5
14608	12mm-1.25	40mm	5
14610*	12mm-1.25	70mm	5
11273	12mm-1.50	20mm	10
11274	12mm-1.50	30mm	10
11275	12mm-1.50	40mm	5
11276	12mm-1.50	50mm	5
14mm (22mm Hex)			
14611	14mm-1.50	30mm	5
14612	14mm-1.50	40mm	5
14613	14mm-1.50	50mm	5
16mm (24mm Hex)			
14616	16mm-1.50	30mm	5
14617	16mm-1.50	40mm	5

\*DIN 931 - Not Fully Threaded



**Metric Low Socket Head Cap Screws**  
DIN 6912

Regular Pitch - Grade 8.8  
Heat Treated Alloy Steel • Plain Finish  
Tensile Strength: 116,000 PSI

Auveco Part No.	Diameter & Pitch	Length	Unit Pkg.
10898	5mm-.8	10mm	10



**Metric Hex Socket Head Cap Screw**  
DIN 912

Regular Pitch - Grade 12.9  
Heat Treated Alloy Steel • Plain Finish  
Tensile Strength: 177,000 PSI

Auveco Part No. Unit Package		Diameter & Pitch	Length
10	100		
10845	10872	4mm-.7	12mm
10846	10873	5mm-.8	12mm
10848	10875	5mm-.8	20mm
10851	10878	6mm-1.00	16mm
10853		6mm-1.00	25mm
10854		6mm-1.00	30mm
10855		8mm-1.25	16mm
10858	10885	8mm-1.25	30mm
10859		8mm-1.25	35mm
10861		10mm-1.50	20mm
10863		10mm-1.50	30mm
10864		10mm-1.50	40mm
10865		10mm-1.50	50mm
10866		12mm-1.75	30mm
10868		12mm-1.75	40mm
10870		12mm-1.75	60mm



**Metric Flat Head Socket Cap Screws**  
DIN 7991

Regular Pitch - Grade 10.9  
Heat Treated Alloy Steel • Plain Finish  
Tensile Strength 150,800 PSI

Auveco Part No. Unit Package		Diameter & Pitch	Length
10	100		
10960	10961	6mm-1.00	16mm
10970		8mm-1.25	20mm
10972		8mm-1.25	25mm



**Metric Hex Key**  
Plain Finish

Use with Din 912 & Din 7991

Auveco Part No.	Hex Size	For Screw Size	Unit Pkg.
7965	3mm	4mm	10

**METRIC ITEMS**



**Metric Socket Set Screws - Cup Point**  
DIN 916

Regular Pitch - Grade 12.9  
Heat Treated Alloy Steel • Plain Finish

Auveco Part No.	Diameter & Pitch	Length	Unit Pkg.
<b>11006</b>	5mm-.8	10mm	10
<b>11024</b>	8mm-1.25	20mm	10
<b>11032</b>	10mm-1.50	20mm	10

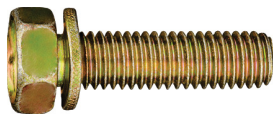

**Hex Head Sems® Split Wave Washer Body Bolts for Import Cars**

Class 9.8 • Zinc & Yellow Dichromate Plated

Auveco Part No.	Size	Hex Size	Washer O.D.	Unit Pkg.
<b>16751</b>	M6-1.0 x 30mm	10mm	11mm	25
<b>16754</b>	M8-1.25 x 30mm	13mm	14mm	25
<b>16755</b>	M8-1.25 x 40mm	13mm	14mm	25



**Hex Head Sems® Split Wave Washer Body Bolts with Flat Washers for Import Cars**

*Flat Washer is packed loose in box*

Class 9.8 • Zinc & Yellow Dichromate Plated

Auveco Part No.	Size	Hex Size	Wave Washer O.D.	Flat Washer O.D.	Unit Pkg.
<b>16761</b>	M8-1.25 x 30mm	13mm	14mm	17mm	25
<b>16762</b>	M8-1.25 x 40mm	13mm	14mm	17mm	25



**Torx® Round Washer Head Body Bolts**  
CA Point • Plated

Auveco Part No.	Size	Finish	Washer Head Dia.	Torx Drive	Unit Pkg.
<b>15807</b>	M6-1.0 x 25mm	Zinc	18mm	T-30	50



**Hex Head Sems® Body Bolts for Import Cars**

Class 8.8 • Zinc & Yellow Dichromate Plated

Auveco Part No.	Size	Hex Size	Washer O.D.	Unit Pkg.
<b>20434</b>	M6-1.0 x 12mm	10mm	12.5mm	50
<b>18177</b>	M6-1.0 x 16mm	10mm	12.5mm	50
<b>20435</b>	M6-1.0 x 20mm	10mm	12.5mm	50
<b>18187</b>	M8-1.25 x 45mm	12mm	17mm	25

**Metric Hex Flange Serrated Bolts**



Serrations under the Head  
Class 10.9  
(Property Class 90)  
Black Phosphate

Auveco Part No.	Size	Hex	Unit Pkg.
<b>16793</b>	M6-1.0 x 16mm	10mm	25
<b>16794</b>	M6-1.0 x 20mm	10mm	25
<b>16795</b>	M8-1.25 x 16mm	13mm	25



**J.I.S. Small Head Hex Flange Bolts**

J.I.S. B1189 • I.S.O. Class 10.9 • Zinc Plated  
10mm Bolts are used with Auveco Hex Flange Nut 16470 on Import Car Exhaust Systems

Auveco Part No.	Size	Hex Size	Flange O.D.	Unit Pkg.
<b>17315</b>	M6-1.0 x 12mm	10mm	14mm	50
<b>17316</b>	M6-1.0 x 16mm	10mm	14mm	50
<b>18807</b>	M6-1.0 x 20mm	10mm	14mm	50
<b>21048</b>	M6-1.0 x 25mm	10mm	14mm	25
<b>18808</b>	M6-1.0 x 30mm	10mm	14mm	25
<b>21049</b>	M6-1.0 x 35mm	10mm	14mm	25
<b>18809</b>	M6-1.0 x 40mm	10mm	14mm	25
<b>21050</b>	M6-1.0 x 45mm	10mm	14mm	25
<b>18980</b>	M8-1.25 x 12mm	12mm	17.5mm	25
<b>17387</b>	M8-1.25 x 16mm	12mm	17.5mm	15
<b>17388</b>	M8-1.25 x 20mm	12mm	17.5mm	15
<b>21051</b>	M8-1.25 x 25mm	12mm	17.5mm	15
<b>17389</b>	M8-1.25 x 30mm	12mm	17.5mm	15
<b>21052</b>	M8-1.25 x 35mm	12mm	17.5mm	15
<b>17390</b>	M8-1.25 x 40mm	12mm	17.5mm	15
<b>21053</b>	M8-1.25 x 45mm	12mm	17.5mm	15

<b>17188</b>	M10-1.25 x 16mm	14mm	20mm	10
<b>17189</b>	M10-1.25 x 20mm	14mm	20mm	10
<b>21054</b>	M10-1.25 x 25mm	14mm	20mm	10
<b>17190</b>	M10-1.25 x 30mm	14mm	20mm	10
<b>21055</b>	M10-1.25 x 35mm	14mm	20mm	10
<b>17191</b>	M10-1.25 x 40mm	14mm	20mm	10
<b>21056</b>	M10-1.25 x 45mm	14mm	20mm	10



**Sec. 7**

**METRIC ITEMS**



**Metric Body Bolt  
Specification Chart**



Auveco Part No.	Size	Length	Hex Size	Washer/ Head O.D.	Type	Point Type	Finish	Unit Pkg.	Page No.
<b>22164</b>	M4-7	16mm	7mm	13mm	Hex Head Sems®	Dog Pt	Phosphate	50	123
<b>12232</b>	M5-0.8	20mm	8mm	12mm	Hex Head Sems	Dog Pt	Phosphate	50	123
<b>22271</b>	M5-0.8	23mm	8mm	18mm	Phillips Hex Head Sems	Dog Pt	Zinc	50	123
<b>21840</b>	M6-1.0	11mm	10mm	15.5mm	Hex Head Flange	C	Black E-Coat	25	123
<b>20434</b>	M6-1.0	12mm	10mm	12.5mm	Hex Head Sems	C	Zinc & Yellow Dichromate	50	120
<b>22293</b>	M6-1.0	15mm	10mm	18mm	Hex Washer Head Sems		Black Phos.	25	123
<b>18177</b>	M6-1.0	16mm	10mm	12.5mm	Hex Head Sems	C	Zinc & Yellow Dichromate	50	120
<b>15791</b>	M6-1.0	16mm	10mm	17mm	Hex Head Sems	C	Black Fluorocarbon	50	123
<b>12064</b>	M6-1.0	16mm	10mm	18.5mm	Hex Head Sems	C	Zinc & Yellow	50	123
<b>20176</b>	M6-1.0	18.5mm	11mm	19mm	Hex Head Sems	Dog Pt.	Phos.	50	123
<b>18515</b>	M6-1.0	20mm	T-30 Drive	13.5mm	Torx® Washer Head	Dog Pt.	Black Organic	25	123
<b>20435</b>	M6-1.0	20mm	10mm	12.5mm	Hex Head Sems	C	Zinc & Yellow Dichromate	50	120
<b>12324</b>	M6-1.0	20mm	10mm	13mm	Hex Washer Head	CA	Blk Phos.	50	123
<b>16826</b>	M6-1.0	20mm	10mm	13mm	Slotted Hex Washer Head	CA	Zinc	50	124
<b>12322</b>	M6-1.0	20mm	10mm	17mm	Hex Head Sems	C	Phos.	25	124
<b>12693</b>	M6-1.0	20mm	10mm	17mm	Hex Head Sems	CA	Phos.	25	124
<b>12067</b>	M6-1.0	20mm	10mm	17mm	Hex Head Sems	C	Phos.	50	124
<b>13617</b>	M6-1.0	20mm	10mm	24mm	Hex Head Sems	CA	Phos.	50	124
<b>12160</b>	M6-1.0	22mm	8mm	19mm	High Hex Head Sems	Dog Pt	Phos.	25	124
<b>15778</b>	M6-1.0	22.5mm	8mm	19mm	Hex Head Sems	Dog Pt	Zinc	50	124
<b>13715</b>	M6-1.0	25mm	10mm	13mm	Hex Washer Head	CA	Phos.	50	124
<b>15807</b>	M6-1.0	25mm	T-30 Drive	18mm	Torx Round Washer Head	CA	Zinc	50	120
<b>12065</b>	M6-1.0	25mm	10mm	17mm	Hex Head Sems	CA	Phos.	50	124
<b>15788</b>	M6-1.0	25mm	10mm	17mm	Hex Head Sems	CA	Zinc	50	124
<b>19455</b>	M6-1.0	25mm	10mm	19mm	Hex Head Sems	Dog Pt	Phos.	25	125
<b>12066</b>	M6-1.0	25mm	10mm	24mm	Hex Head Sems	CA	Phos.	50	125
<b>12323</b>	M6-1.0	25mm	10mm	24mm	Hex Head Sems	CA	Blk Polyseal	25	125
<b>14947</b>	M6-1.0	26mm	T-30 Drive	16mm	Pan Head Torx Sems	Dog Pt	Stainless Steel	25	125
<b>15779</b>	M6-1.0	28mm	8mm	19mm	Hex Head Sems	Dog Pt	Blk Zinc Phos.	50	125
<b>12335</b>	M6-1.0	28mm	8mm	19mm	Hex Head Sems	Dog Pt	Zinc & Yellow	25	125
<b>16893</b>	M6-1.0	28mm	8mm	25mm	Hex Head Sems	Dog Pt	Phos.	25	125
<b>16751</b>	M6-1.0	30mm	10mm	11mm	Hex Head Sems® Split Wave Washer	C	Zinc & Yellow Dichromate	25	120

(Continued on next page)

## METRIC ITEMS

## Sec. 7

Metric Body Bolt  
Specification Chart

Auveco Part No.	Size	Length	Hex Size	Washer/ Head O.D.	Type	Point Type	Finish	Unit Pkg.	Page No.
<b>22232</b>	M6-1.0	30mm	10mm	18mm	Hex Head Sems	Dog Pt	Black Zinc	25	125
<b>15818</b>	M6-1.0	30mm	10mm	19mm	Hex Head Sems	Dog Pt	Phos.	50	125
<b>20261</b>	M6-1.0	30mm	10mm	20mm	Hex Head Sems	CA	Phos.	25	126
<b>13618</b>	M6-1.0	30mm	10mm	24mm	Hex Head Sems	CA	Phos.	50	126
<b>18416</b>	M6-1.0	35mm	10mm	17mm	Hex Head Sems	CA	Blk Phos.	50	126
<b>11633</b>	M6.3-1.0	20mm	10mm	17mm	Hex Head Sems	CA	Phos.	25	126
<b>11935</b>	M6.3-1.0	25mm	10mm	17mm	Hex Head Sems	CA	Zinc	25	126
<b>11638</b>	M8-1.25	16mm	13mm	18mm	Hex Washer Head with Serrations Under the Head	Dog Pt	Phos	25	126
<b>13704</b>	M8-1.25	20mm	13mm	24mm	Hex Head Sems	CA	Phos	25	126
<b>12336</b>	M8-1.25	25mm	13mm	17mm	Hex Washer Head	CA	Phos.	25	126
<b>15790</b>	M8-1.25	25mm	13mm	17mm	Hex Head Sems	CA	Phos.	50	126
<b>11639</b>	M8-1.25	25mm	13mm	17mm	Hex Washer Head	CA	Phos.	25	126
<b>13613</b>	M8-1.25	25mm	13mm	24mm	Hex Head Sems	CA	Phos.	25	126
<b>16754</b>	M8-1.25	30mm	13mm	14mm	Hex Head Sems Split Wave Washer	C	Zinc & Yellow Dichromate	25	120
<b>16761</b>	M8-1.25	30mm	13mm	14mm & 17mm	Hex Head Sems Split Wave Washer & Flat Washer	C	Zinc & Yellow Dichromate	25	120
<b>12348</b>	M8-1.25	30mm	13mm	17mm	Hex Washer Head	CA	Phos.	25	127
<b>11640</b>	M8-1.25	30mm	13mm	17mm	Hex Washer Head	CA	Zinc Organic	25	127
<b>13614</b>	M8-1.25	30mm	13mm	24mm	Hex Head Sems	CA	Phos.	25	127
<b>15780</b>	M8-1.25	33mm	10mm	22mm	Hex Head Sems	Dog Pt	Phos.	50	127
<b>12343</b>	M8-1.25	35mm	13mm	17mm	Hex Washer Head	CA	Phos.	25	127
<b>13705</b>	M8-1.25	35mm	13mm	24mm	Hex Head Sems	CA	Phos.	25	127
<b>16755</b>	M8-1.25	40mm	13mm	14mm	Hex Head Sems Split Wave Washer	C	Zinc & Yellow Dichromate	25	120
<b>16762</b>	M8-1.25	40mm	13mm	14mm & 17mm	Hex Head Sems Split Wave Washer & Flat Washer	C	Zinc & Yellow Dichromate	25	120
<b>16931</b>	M8-1.25	42mm	10mm	22mm	Hex Head Sems	Dog Pt	Phos.	25	127
<b>18187</b>	M8-1.25	45mm	12mm	17mm	Hex Head Sems	C	Zinc & Yellow Dichromate	25	120
<b>13619</b>	M10-1.50	30mm	15mm	29mm	Hex Head Sems	CA	Phos.	10	127
<b>12327</b>	M10-1.50	33mm	13mm	20mm	Hex Washer Head	Dog Pt	Phos.	25	127
<b>11641</b>	M10-1.50	40mm	15mm	29mm	Hex Head Sems	CA	Phos.	25	127

**Sec. 7**

**METRIC ITEMS**



**22164**  
(GM: 11502618)  
Phosphate

M4-.7 x 16mm  
Hex Head Sems® with Dog Point  
Washer Diameter: 13mm  
Hex: 7mm  
GM

UNIT PACKAGE: 50



**12232**  
(6100539)  
Phosphate

M5-0.8 x 20mm  
Hex Head Sems®  
Thread Cutting Screw with Dog Point  
Outer Diameter Washer: 12mm (1/2")  
Hex: 8mm  
Chrysler

UNIT PACKAGE: 50



**22271**  
(Subaru: 901935002)  
Black Zinc

M5-0.8 x 23mm  
Phillips Hex Head Sems®  
Body Bolt with Dog Point  
Washer Diameter: 18mm  
Hex Size: 8mm

**Use with Auveco 22175**  
Subaru Forester & Legacy 1995 - On

UNIT PACKAGE: 50



**21840**  
(Toyota: 90105-06037)  
Black E-Coat

M6-1.0 x 11mm  
Hex Head Flange  
Flange Outer Diameter: 15.5mm  
Hex: 10mm  
Luggage Compartment Door & Lock and Radiator Grille  
Toyota & Lexus 2001 - On

UNIT PACKAGE: 25



**22293**  
(Mazda: 9GG600616T)  
Black Phosphate

M6-1.0 x 15mm  
Hex Washer Head Sems®  
Washer Outer Diameter: 18mm  
Hex: 10mm  
Fender Liner  
Mazda 1996 - On

UNIT PACKAGE: 25



**15791**  
(11508930)  
Black Fluorocarbon

M6-1.0 x 16mm  
Hex Head Sems®  
Class 9.8  
Washer Outer Diameter: 17mm (21/32")  
Hex: 10mm  
GM

UNIT PACKAGE: 50



**12064**  
(11503812)  
Zinc & Yellow

M6-1.0 x 16mm  
Hex Head Sems®  
Class 9.8  
Washer Outer Diameter: 18.5mm (47/64")  
Hex: 10mm  
GM

UNIT PACKAGE: 50

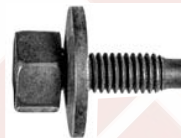

**20176**  
(N800510-S100)  
Phosphate

M6-1.0 x 18.5mm  
Hex Head Sems® with Dog Point  
Class 9.8  
Washer Outer Diameter: 19mm (3/4")  
Hex: 11mm

**Replaces Auveco 15719**  
Ford

UNIT PACKAGE: 50



**18515**  
(21094240)  
Black  
500 Hour Salt Spray

M6-1.0 x 20mm  
Torx® Washer Head with Dog Point &  
Sealant on Threads  
T-30 Drive  
Washer Head Outer Diameter: 13.5  
Front & Rear Door Lock  
GM Saturn

UNIT PACKAGE: 25



**12324**  
(11503800)  
Phosphate

M6-1.0 x 20mm  
Hex Washer Head  
Class 9.8  
Washer Head Outer Diameter: 13mm (1/2")  
Hex: 10mm  
GM

UNIT PACKAGE: 50



# METRIC ITEMS

## Sec. 7

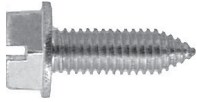

**16826**

(Chry: 34201287;  
AMC: 8934201287)  
Zinc

M6-1.0 x 20mm  
Slotted Hex Washer Head  
License Plate Screw  
Washer Head O.D.: 13mm (1/2")  
Hex: 10mm  
Chrysler, Honda & AMC

UNIT PACKAGE: 50



**12322**

(11503815, 11508023)  
Phosphate

M6-1.0 x 20mm  
Hex Head Sems® with Grounding Teeth  
Class 9.8  
Washer Outer Diameter: 17mm (21/32")  
Hex: 10mm  
GM

UNIT PACKAGE: 25



**12693**

(11502941, 11506174)  
Phosphate

M6-1.0 x 20mm  
Hex Head Sems®  
Class 9.8  
Washer Outer Diameter: 17mm (21/32")  
Hex: 10mm  
GM

UNIT PACKAGE: 25



**12067**

(11504570, 11509816, 11514623)  
Phosphate

M6-1.0 x 20mm  
Hex Head Sems®  
Class 9.8  
Washer Outer Diameter: 17mm (21/32")  
Hex: 10mm  
GM

UNIT PACKAGE: 50



**13617**

(11503941)  
Phosphate

M6-1.0 x 20mm  
Hex Head Sems®  
Class 9.8  
Washer Outer Diameter: 24mm (15/16")  
Hex: 10mm  
GM

UNIT PACKAGE: 50



**15778**

(N606676-S36)  
Zinc

M6-1.0 x 22.5mm  
Hex Head Sems® with Dog Point  
Class 9.8  
Washer Outer Diameter: 19mm (3/4")  
Hex: 8mm  
Ford

UNIT PACKAGE: 50



**12160**

(N606676-S2, S100)  
Phosphate

M6-1.0 x 22mm  
High Hex Head Sems® with Dog Point  
Class 9.8  
Washer Outer Diameter: 19mm (3/4")  
Hex: 8mm  
Ford

UNIT PACKAGE: 25



**13715**

(11503958)  
Phosphate

M6-1.0 x 25mm  
Hex Washer Head  
Class 9.8  
Washer Head Outer Diameter: 13mm (1/2")  
Hex: 10mm  
GM

UNIT PACKAGE: 50



**12065**

(11503834, 20351035)  
Phosphate

M6-1.0 x 25mm  
Hex Head Sems®  
Class 9.8  
Washer Outer Diameter: 17mm (21/32")  
Hex: 10mm  
GM

UNIT PACKAGE: 50



**15788**

(11503833)  
Zinc

M6-1.0 x 25mm  
Hex Head Sems®  
Washer Outer Diameter: 17mm (21/32")  
Hex: 10mm  
GM

UNIT PACKAGE: 50

**Sec. 7**

**METRIC ITEMS**



**19455**  
(6100567)  
Phosphate

M6-1.0 x 25mm  
Hex Head Sems® with Dog Point  
Class 9.8  
Washer Outer Diameter: 19mm (3/4")  
Hex: 10mm  
Grille, Fender, Hood Prop & Latch  
Chrysler

UNIT PACKAGE: 25

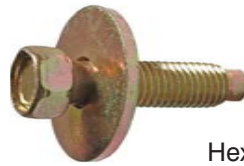

**12335**  
(N606677-S36)  
Zinc & Yellow

M6-1.0 x 28mm  
Hex Head Sems® with Dog Point  
Class 9.8  
Washer Outer Diameter: 19mm (3/4")  
Hex: 8mm  
Ford

UNIT PACKAGE: 25



**12066**  
(11503982)  
Phosphate

M6-1.0 x 25mm  
Hex Head Sems®  
Class 9.8  
Washer Outer Diameter: 24mm (15/16")  
Hex: 10mm  
GM

UNIT PACKAGE: 50



**16893**  
(N800947-S, AB-181-GG)  
Phosphate

M6-1.0 x 28mm  
Hex Head Sems® with Dog Point  
Class 9.8  
Washer Outer Diameter: 25mm (1")  
Hex: 8mm  
Ford

UNIT PACKAGE: 25



**12323**  
(11504493)  
Black Polyseal

M6-1.0 x 25mm  
Hex Head Sems®  
Class 9.8  
Washer Outer Diameter: 24mm (15/16")  
Hex: 10mm  
GM

UNIT PACKAGE: 25



**22232**  
(Ford: W711390-S900)  
Black Zinc

M6-1.0 x 30mm  
Hex Head Sems  
with Dog Point & Thread Locking Patch  
Washer Outer Diameter: 18mm (23/32")  
Hex: 10mm  
Ford F-150 Trucks with Aluminum Body 2015 - On

UNIT PACKAGE: 25



**14947**  
(N801851-S45)  
Stainless Steel

M6-1.0 x 26mm  
Pan Head Internal Torx® Drive Sems®  
T-30 Drive  
Head Diameter: 14mm  
Washer Outer Diameter: 16mm (5/8")  
Truck Mirror Mounting Bracket Bolt  
Ford Trucks

UNIT PACKAGE: 25



**15818**  
(6100568)  
Phosphate

M6-1.0 x 30mm  
Hex Head Sems® with Dog Point  
Class 9.8  
Washer Outer Diameter: 19mm (3/4")  
Hex: 10mm  
Chrysler

UNIT PACKAGE: 50

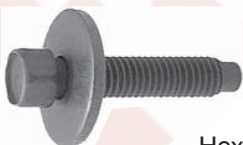

**15779**  
(N606677-S53B)  
Black Zinc Phosphate

M6-1.0 x 28mm  
Hex Head Sems® with Dog Point  
Washer Outer Diameter: 19mm (3/4")  
Hex: 8mm  
Ford

UNIT PACKAGE: 50



**20261**  
(10287379)  
Phosphate

M6-1.0 x 30mm  
Hex Head Sems®  
Class 9.8  
Washer Outer Diameter: 20mm (13/16")  
Hex: 10mm  
GM

UNIT PACKAGE: 25

**METRIC ITEMS**



**13618**  
(11503825)  
Phosphate

M6-1.0 x 30mm  
Hex Head Sems®  
Class 9.8  
Washer Outer Diameter: 24mm (15/16")  
Hex: 10mm  
GM

UNIT PACKAGE: 50

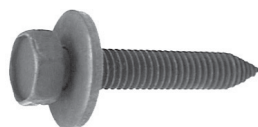

**18416**  
(11505044)  
Black Phosphate

M6-1.0 x 35mm  
Hex Head Sems®  
Class 9.8  
Washer Outer Diameter: 17mm (21/32")  
Hex: 10mm  
GM

UNIT PACKAGE: 50



**11633**  
(11501105)  
Phosphate

M6.3-1.0 x 20mm  
Hex Head Sems®  
Class 9.8  
Washer Outer Diameter: 17mm (21/32")  
Hex: 10mm  
GM

UNIT PACKAGE: 25



**11935**  
(11502790)  
Zinc

M6.3-1.0 x 25mm  
Hex Head Sems®  
Class 9.8  
Washer Outer Diameter: 17mm (21/32")  
Hex: 10mm  
GM

UNIT PACKAGE: 25



**11638**  
(362029m 11509589)  
Phosphate

M8-1.25 x 22mm  
Hex Washer Head with Serrations  
under the Head & Dog Point  
Washer Head Outer Diameter: 18mm (23/32")  
Hex: 13mm  
GM

UNIT PACKAGE: 25



**13704**  
Phosphate

M8-1.25 x 20mm  
Hex Head Sems®  
Class 9.8  
Washer Outer Diameter: 24mm (15/16")  
Hex: 13mm

UNIT PACKAGE: 25

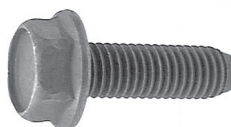

**11639**  
(11502605,  
11502624, 11509511)  
Phosphate

M8-1.25 x 25mm  
Hex Washer Head  
Class 9.8  
Washer Head O.D.: 17mm (21/32")  
Hex: 13mm  
GM

UNIT PACKAGE: 25



**12336**  
(11503632)  
Phosphate

M8-1.25 x 25mm  
Hex Washer Head  
Class 9.8  
Washer Head Outer Diameter: 17mm (21/32")  
Hex: 13mm  
GM

UNIT PACKAGE: 25



**15790**  
(11505326)  
Phosphate

M8-1.25 x 25mm  
Hex Head Sems®  
Class 9.8  
Washer Outer Diameter: 17mm (21/32")  
Hex: 13mm  
GM

UNIT PACKAGE: 50



**13613**  
(11503619)  
Phosphate

M8-1.25 x 25mm  
Hex Head Sems®  
Class 9.8  
Washer Outer Diameter: 24mm (15/16")  
Hex: 13mm  
GM

UNIT PACKAGE: 25



**Sec. 7**

**METRIC ITEMS**



**12348**  
(11500971)  
Phosphate

M8-1.25 x 30mm  
Hex Washer Head  
Class 9.8  
Washer Head Outer Diameter: 17mm (21/32")  
Hex: 13mm  
GM

UNIT PACKAGE: 25



**13705**  
(11503668)  
Phosphate

M8-1.25 x 35mm  
Hex Head Sems®  
Class 9.8  
Washer Outer Diameter: 24mm (15/16")  
Hex: 13mm  
GM

UNIT PACKAGE: 25



**11640**  
(549790, 11500971)  
Zinc Organic

M8-1.25 x 30mm  
Hex Washer Head  
Class 9.8  
Washer Head Outer Diameter: 17mm (21/32")  
Hex: 13mm  
GM

UNIT PACKAGE: 25

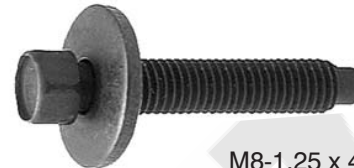

**16931**  
(N606692-S2,  
AB-187EH)  
Phosphate

M8-1.25 x 42mm  
Hex Head Sems® with Dog Point  
Class 9.8  
Washer Outer Diameter: 22mm (7/8")  
Hex: 10mm  
Ford

UNIT PACKAGE: 25



**13614**  
(11501188)  
Phosphate

M8-1.25 x 30mm  
Hex Head Sems®  
Class 9.8  
Washer Outer Diameter: 24mm (15/16")  
Hex: 13mm  
GM

UNIT PACKAGE: 25



**13619**  
Phosphate

M10-1.50 x 30mm  
Hex Head Sems®  
Class 9.8  
Washer Outer Diameter: 29mm (1-1/8")  
Hex: 15mm

UNIT PACKAGE: 10



**15780**  
(N606690-S2)  
Phosphate

M8-1.25 x 33mm  
Hex Head Sems® with Dog Point  
Class 9.8  
Washer Outer Diameter: 22mm (7/8")  
Hex: 10mm  
Ford

UNIT PACKAGE: 50



**12327**  
(N605920-S2)  
Phosphate

M10-1.50 x 33mm  
Hex Washer Head with Dog Point  
Class 9.8  
Washer Head O.D.: 20mm (13/16")  
Hex: 13mm  
Ford

UNIT PACKAGE: 25



**12343**  
(11504982)  
Phosphate

M8-1.25 x 35mm  
Hex Washer Head  
Class 9.8  
Washer Head Outer Diameter: 17mm (21/32")  
Hex: 13mm  
GM

UNIT PACKAGE: 25



**11641**  
(11501193)  
Phosphate

M10-1.50 x 40mm  
Hex Head Sems®  
Class 9.8  
Washer Outer Diameter: 29mm (1-5/32")  
Hex: 15mm  
GM

UNIT PACKAGE: 25

## METRIC ITEMS

## Sec. 7

**13620**

Phosphate

M10-1.50 x 45mm

Hex Head Sems®

Class 9.8

Washer Outer Diameter: 30mm (1-3/16")

Hex: 15mm

UNIT PACKAGE: 10

## Metric Special Tapping Screw Specification Chart

Auveco Part No.	Size	Length	Hex Size	Washer/ Head O.D.	Type	Point Type	Finish	Unit Pkg.	Page No.
<b>12062</b>	M4.2-1.41 (#8)	10mm (13/32")		11mm (7/16")	Phillips Washer Head Pozi-Drive	AB	Black Oxide	100	131
<b>15941</b>	M4.2-1.41 (#8)	12mm (15/32")		9.5mm (3/8")	Phillips Truss Head	AB	Black Oxide	10	131
<b>16596</b>	M4.2-1.41 (#8)	12mm (15/32")		9.5mm (3/8")	Phillips Truss Head	AB	Black Oxide	100	131
<b>12739</b>	M4.2-1.41 (#8)	12mm (15/32")		10mm (25/64")	Phillips Washer Head Pozi-Drive	AB	Chrome	100	131
<b>12059</b>	M4.2-1.41 (#8)	13mm (33/64")		11mm (7/16")	Phillips Washer Head	AB	Zinc	100	131
<b>12061</b>	M4.2-1.41 (#8)	13mm (33/64")		8.5mm (11/32")	Phillips Round Washer Head, Pozi-Drive	AB	Black Oxide	100	131
<b>13712</b>	M4.2-1.41 (#8)	13mm (33/64")		11mm (7/16")	Phillips Washer Head	AB	Black Zinc	50	131
<b>12740</b>	M4.2-1.41 (#8)	13mm (33/64")	7mm	12mm (15/32")	Hex Head Sems	AB	Phosphate	100	131
<b>15721</b>	M4.2-1.41 (#8)	13mm (33/64")	7mm	16mm (5/8")	Hex Head Sems	AB	Phosphate	50	131
<b>18781</b>	M4.2-1.41 (#8)	14mm (9/16")	7mm	8mm (5/16")	Hex Head Sems	AB	Phosphate	50	131
<b>21122</b>	M4.2-1.41 (#8)	14mm (9/16")		11mm (7/16")	Phillips Washer Head Pozi-Drive	Teks®	Chrome	50	131
<b>18817</b>	M4.2-1.41 (#8)	16mm (5/8")		11mm (7/16")	Phillips Round Washer Head, Pozi-Drive	Teks	Black Zinc	100	132
<b>16720</b>	M4.2-1.41 (#8)	16mm (5/8")		9.5mm (3/8")	Phillips Truss Head	AB	Black Oxide	100	132
<b>12741</b>	M4.2-1.41 (#8)	16mm (5/8")	7mm	12mm (15/32")	Hex Head Sems	AB	Phosphate	100	132
<b>18261</b>	M4.2-1.41 (#8)	16mm (5/8")	7mm	12mm (15/32")	Hex Washer Head Sems	Teks	Phosphate	50	132
<b>12060</b>	M4.2-1.41 (#8)	20mm (25/32")		11mm (7/16")	Phillips Washer Head	AB	Black Oxide	100	132
<b>12097</b>	M4.2-1.41 (#8)	20mm (25/32")		12mm (15/32")	Phillips Pan Head Sems®	AB	Chrome	50	132
<b>12738</b>	M4.2-1.41 (#8)	20mm (25/32")	7mm	12mm (15/32")	Hex Washer Head Sems	AB	Phosphate	50	132
<b>12742</b>	M4.2-1.41 (#8)	20mm (25/32")	7mm	12mm (15/32")	Hex Head Sems	AB	Phosphate	100	132
<b>15373</b>	M4.2-1.41 (#8)	20mm (25/32")	7mm	16mm (5/8")	Hex Head Sems	AB	Phosphate	50	132
<b>20271</b>	M4.2-1.41 (#8)	20mm (25/32")		16mm (5/8")	Phillips Pan Head Sems	AB	Phosphate	50	132
<b>20476</b>	M4.2-1.41 (#8)	20mm (25/32")	7mm	17mm (11/16")	Hex Washer Head Sems	Teks	Phosphate	50	132

(Continued on next page)

## Sec. 7

## Metric Special Tapping Screw Specification Chart

Auveco Part No.	Size	Length	Hex Size	Washer/ Head O.D.	Type	Point Type	Finish	Unit Pkg.	Page No.
19278	M4.2-1.41 (#8)	20mm (25/32")	7mm	20mm (25/32")	Hex Head Sems	AB	Black Phos.	50	132
15775	M4.2-1.41 (#8)	20mm (25/32")	7mm	12mm (15/32")	Hex Head Sems	Teks®	Phosphate	50	133
22070	M4.2-1.41 (#8)	20mm (25/32")		17mm (11/16")	Torx® Pan Head Sems®	Dog Pt	Black Zinc	50	133
22104	M4.2-1.41	22mm	5.5mm	16mm	Hex Head Sems	AB	Black Zinc	50	133
14053	M4.2-1.41 (#8)	25mm (1")		7mm (9/32")	Torx Oval Head	AB	Black Oxide	50	130
19006	M4.2-1.41 (#8)	25mm (1")		11mm (7/16")	Round Washer Head, Pozi-Drive	Teks	Phosphate	100	133
20382	M4.2-1.41 (#8)	25mm (1")	T-15 Drive	12mm (15/32")	Torx Pan Head Sems	AB	Black Zinc	50	133
22081	M4.2-1.41	25mm		17mm	Pozi-Drive Round Washer Head Sems	AB	Black Zinc	50	133
18336	M4.2-1.41 (#8)	25mm (1")	7mm	12mm (15/32")	Hex Head Sems	AB	Black Phos	100	133
19653	M4.2-1.41 (#8)	30mm (1-3/16")	7mm	17mm (11/16")	Hex Head Sems	AB	Black Phos	15	133
18340	M4.8-1.61 (#10)	15mm (19/32")		14mm (9/16")	Phillips Truss Head	AB	Black Phos	50	133
17459	M4.8-1.61 (#10)	16mm (5/8")		11mm (7/16")	Phillips Truss Head	AB	Black Oxide	100	133
22030	M4.8-1.61 (#10)	16mm (5/8")	8mm	18mm	Hex Head Sems	AB	Black Zinc	50	133
22110	M4.8-1.61	18mm	T-25 Drive	15mm	Torx Truss Head	AB	Black Zinc	25	133
21774	M4.8-1.61 (#10)	20mm (25/32")	8mm	26mm	Hex Head Sems	AB	Black E-Coat	25	134
20259	M4.8-1.61 (#10)	19mm (3/4")		16mm (5/8")	Phillips Truss Head Sems	AB	Black E Coat	25	134
16589	M4.8-1.61 (#10)	19mm (3/4")	8mm	15mm (19/32")	Hex Head Sems	AB	Zinc & Yellow Dichromate	50	134
21865	M4.8-1.61 (#10)	32mm (1-1/4")	8mm	19mm (3/4")	Hex Head Sems	AB	Phosphate	50	134
21746	M5-1.59	11mm		11mm	Phillips Truss Head	AB	Black Oxide	50	134
21747	M5-1.59	11mm		12mm	Phillips Round Washer Head	AB	Black Oxide	50	134
19251	M5-1.59	16mm	8mm	16mm	Phillips Hex Head Sems	A	Black Zinc	50	134
22294	M5-1.81	16mm	8mm	16mm	Phillips Hex Head Sems	B	Black Phos.	25	134
22203	M5-1.81	20mm		13mm	Phillips Flat Head	AB	Black Phos.	100	134
21841	M5.2-2.0 (#12)	20mm (25/32")	8mm	12mm (1/2")	Phillips Hex Head Sems®	AB	Black E-Coat	25	134
21839	M5.2-2.0 (#12)	21mm (13/16")	10mm	14mm (9/16")	Phillips Hex Head Sems	AB	Zinc	25	134
22111	M5-2.12 (#12)	19mm (3/4")	T-25 Drive	14mm	Torx Truss Head	AB	Black Zinc	25	134
20455	M5 (#12)	20mm (25/32")		14mm (9/16")	Phillips Truss Head	AB	Black Phos	50	135
21541	M5.5 (#12)	20mm (25/32")	T-20 Drive	15mm (19/32")	Torx® Truss Head	AB	Black Zinc	25	135
22292	M5.5-1.81 (#12)	16mm (5/8")		13mm (33/64")	Phillips Truss Head		Black Phos.	25	135
17461	M5.5-1.81 (#12)	18mm (45/64")	8mm	15mm (19/32")	Hex Head Sems	AB	Zinc & Yellow Dichromate	50	135
21744	M6-1.81	20mm	10mm	13mm	Phillips Hex Head Sems	AB	Black E-Coat	25	135

(Continued on next page)



# Metric Special Tapping Screw Specification Chart

## Sec. 7

Auveco Part No.	Size	Length	Hex Size	Washer/ Head O.D.	Type	Point Type	Finish	Unit Pkg.	Page No.
19170	M6.3-1.81 (#14)	16mm (5/8")		15mm (19/32")	Phillips Truss Head	AB	Black Phos.	50	135
15776	M6.3-1.81 (#14)	16mm (5/8")	8mm	16mm (5/8")	Hex Head Sems	AB	Phosphate	50	135
12057	M6.3-1.81 (#14)	16mm (5/8")	10mm	17mm (11/16")	Hex Head Sems	AB	Phosphate	50	135
22106	M6.3-2.5	18mm	10mm	14mm	Phillips Hex Head Sems	AB	Zinc	25	136
15962	M6.3-1.81 (#14)	18mm (23/32")	10mm	22mm (7/8")	Hex Head Sems	AB	Zinc & Yellow Dichromate	25	135
13019	M6.3-1.81 (#14)	19mm (3/4")	8mm	11.5mm (29/64")	Hex Washer Head	AB	Phosphate	50	135
20556	M6.3-1.81 (#14)	20mm (25/32")	10mm	16mm (5/8")	Phillips Hex Head Sems	AB	Black Zinc	50	135
12351	M6.3-1.81 (#14)	20mm (25/32")	10mm	17mm (11/16")	Hex Washer Head Sems	AB	Black Phos.	50	136
16828	M6.3-1.81 (#14)	20mm (25/32")	10mm	18mm (45/64")	Hex Head Sems	AB	Zinc & Yellow Dichromate	25	136
20557	M6.3-1.81 (#14)	20mm (25/32")	10mm	20mm (25/32")	Phillips Hex Head Sems	AB	Black Zinc	50	136
21838	M6.3-2.5 (#14)	24mm (15/16")	10mm	16mm (5/8")	Phillips Hex Head Sems	AB	Zinc	25	136
12339	M6.3-1.81 (#14)	25mm (1")	10mm	17mm (11/16")	Hex Head Sems	AB	Phosphate	50	136
12354	M6.3-1.81 (#14)	30mm (1-3/16")	10mm	17mm (11/16")	Hex Head Sems	AB	Phosphate	50	136
12068	M6.3-1.81 (#14)	30mm (1-3/16")	10mm	24mm (15/16")	Hex Head Sems	AB	Phosphate	50	136
22295	M6.5-1.81	18mm		16mm	Phillips Truss Head		Black Phos.	25	136
22296	M6.5-1.81	25mm		16mm	Phillips Truss Head		Black Phos.	25	136
21837	M6.5-2.5	19mm	10mm	20mm	Phillips Hex Head Sems	AB	Black E-Coat	25	136
19417	M7.5	35mm (1-3/8")	#3 Sq. Drive	22mm (7/8")	Nylon Square Drive Truss Head	AB	Black Nylon	15	137
12350	M8-2.12 (5/16"-12)	20mm (25/32")	13mm	16mm (5/8")	Hex Washer Head	AB	Phosphate	25	137
21517	M9.5	46mm (1-13/16")	#3 Sq. Drive	22mm (7/8")	Nylon Square Drive Truss Head	AB	Black Nylon	25	137
20970	M14	34mm (1-11/32")	#3 Sq. Drive	22mm (7/8")	Nylon Square Drive Truss Head	AB	Black Nylon	25	137

### Metric Torx® Head Tapping Screws



300 Series Stainless Steel

Auveco Part No.	Size	Head Style	GM Number	Finish	Unit Pkg.
14053	M4.2-1.41 x 25mm	M7 Oval	11505182	Black Ox	50

**Sec. 7**

**METRIC ITEMS**



**Metric Torx® Insert Bits  
for Torx Screws  
1" Shank**

Auveco Part No.	Bit Size	For Screw Size	Unit Pkg.
12472	T-10	No. 4	1
11949	T-15	No. 6, M4.2	1
11950	T-20	No. 8, M4.2	1
12103	T-25	No. 10	1
14913	T-27	No. 12, 1/4"	1
12104	T-30	1/4", M6	1
12105	T-40	5/16", M8	1
14916*	T-55	1/2", 9/16", 5/8"	1

\* 1/4" Shank



**12062**  
(11501903)  
Black Oxide

M4.2-1.41 x 10mm (#8 x 13/32")  
Phillips Washer Head  
Pozi-Drive  
Washer Head Outer Diameter: 11mm (7/16")  
GM

UNIT PACKAGE: 100



**15941**  
Black Oxide

M4.2-1.41 x 12mm (#8 x 15/32")  
Phillips Truss Head  
Head Diameter: 9.5mm (3/8")  
Japanese Imports

UNIT PACKAGE: 10

**16596**

Same as 15941 except for unit package quantity

UNIT PACKAGE: 100



**12059**  
(11501883)  
Zinc

M4.2-1.41 x 13mm (#8 x 33/64")  
Phillips Washer Head  
Pozi-Drive  
Washer Head Outer Diameter: 11mm (7/16")  
GM

UNIT PACKAGE: 100



**12061**  
(11501896)  
Black Oxide

M4.2-1.41 x 13mm (#8 x 33/64")  
Phillips Round Washer Head  
Pozi-Drive  
Washer Head Outer Diameter: 8.5mm (11/32")  
GM

UNIT PACKAGE: 100



**12739**  
(11501794)  
Chrome

M4.2-1.41 x 12mm (#8 x 15/32")  
Phillips Washer Head  
Pozi-Drive  
Washer Head Outer Diameter: 10mm (25/64")  
GM

UNIT PACKAGE: 100



**13712**  
(11505104)  
Black Zinc

M4.2-1.41 x 13mm (#8 x 33/64")  
Phillips Washer Head  
Washer Head Outer Diameter: 11mm (7/16")  
GM

UNIT PACKAGE: 50



**12740**  
(11503394)  
Phosphate

M4.2-1.41 x 13mm (#8 x 33/64")  
Hex Head Sems®  
Washer Outer Diameter: 12mm (15/32")  
Hex: 7mm  
GM

UNIT PACKAGE: 100



**15721**  
(11504010)  
Phosphate

M4.2-1.41 x 13mm (#8 x 19/32")  
Indented Hex Head Sems®  
Washer Outer Diameter: 16mm (5/8")  
Hex: 7mm  
GM

UNIT PACKAGE: 50



**21122**  
Chrome

M4.2-1.41 x 14mm (#8 x 9/16")  
Phillips Pozi Drive  
Washer Head TekS®  
Washer Head Outer Diameter: 11mm (7/16")

UNIT PACKAGE: 50



**18781**  
(11515566)  
Phosphate

M4.2-1.41 x 14mm (#8 x 9/16")  
Hex Head Sems®  
Washer Outer Diameter: 8mm (5/16")  
Hex: 7mm  
GM

UNIT PACKAGE: 50

**METRIC ITEMS**



**18817**  
(1746408)  
Black Zinc

M4.2-1.41 x 16mm (#8 x 41/64")  
Phillips Round Washer Head with  
Serrations under the Head  
Pozi-Drive with Teks® Point  
Washer Head Outer Diameter: 11mm (7/16")  
Moulding, Trim & General Purpose  
GM

UNIT PACKAGE: 100



**16720**  
Black Oxide

M4.2-1.41 x 16mm (#8 x 5/8")  
Phillips Truss Head  
Head Diameter: 9.5mm (3/8")  
Honda

UNIT PACKAGE: 100



**12741**  
(11503395)  
Phosphate

M4.2-1.41 x 16mm (#8 x 5/8")  
Hex Head Sems®  
Washer Outer Diameter: 12mm (15/32")  
Hex: 7mm  
GM

UNIT PACKAGE: 100



**18261**  
(11503578, 11503785)  
Phosphate

M4.2-1.41 x 16mm (#8 x 5/8")  
Hex Washer Head Sems® with Teks® Point  
Washer Outer Diameter: 12mm (1/2")  
Hex: 7mm  
GM

UNIT PACKAGE: 50

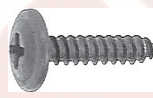

**12060**  
(11501884)  
Black Oxide

M4.2-1.41 x 20mm (#8 x 25/32")  
Phillips Washer Head  
Washer Head Outer Diameter: 11mm (7/16")  
GM

UNIT PACKAGE: 100



**12097**  
(9420052, 11502483, 11503503)  
Chrome

M4.2-1.41 x 20mm (#8 x 25/32")  
Phillips Pan Head Sems®  
Pozi-Drive  
Washer Outer Diameter: 12mm (1/2")  
GM

UNIT PACKAGE: 50



**12738**  
(11504056, 11513801)  
Phosphate

M4.2-1.41 x 20mm (#8 x 25/32")  
Hex Washer Head Sems®  
Washer Outer Diameter: 12mm (1/2")  
Hex: 7mm  
Radiator & Grille  
GM

UNIT PACKAGE: 50



**12742**  
(11503396, 11503483)  
Phosphate

M4.2-1.41 x 20mm (#8 x 25/32")  
Hex Head Sems®  
Washer Outer Diameter: 12mm (1/2")  
Hex: 7mm  
Front End & Air Conditioner  
GM

UNIT PACKAGE: 100



**15373**  
(11503892, 11500434)  
Phosphate

M4.2-1.41 x 20mm (#8 x 25/32")  
Hex Head Sems®  
Washer Outer Diameter: 16mm (5/8")  
Hex: 7mm  
GM

UNIT PACKAGE: 50



**20271**  
(N801603-S2)  
Phosphate

M4.2-1.41 x 20mm (#8 x 25/32")  
Phillips Pan Head Sems®  
Washer Outer Diameter: 16mm (5/8")  
Ford

UNIT PACKAGE: 50



**20476**  
Phosphate

M4.2-1.41 x 20mm (#8 x 25/32")  
Hex Washer Head Sems® Teks®  
Washer Outer Diameter: 17mm (11/16")  
Hex: 7mm  
General Purpose

UNIT PACKAGE: 50



**19278**  
(GM: 14090382; Chry: 6506161-AA)  
Black Phosphate

M4.2-1.41 x 20mm (#8 x 25/32")  
Hex Head Sems®  
Washer Outer Diameter: 20mm  
Hex: 7mm  
GM

UNIT PACKAGE: 50



**Sec. 7**

**METRIC ITEMS**



**15775**

Phosphate

M4.2-1.41 x 20mm (#8 x 25/32")  
Hex Head Sems® with Tek's® Point  
Washer Outer Diameter: 12mm (1/2")  
Hex: 7mm

UNIT PACKAGE: 50



**22070**

(GM: 11570637)

Black Zinc

M4.2-1.41 x 20mm (#8 x 25/32")  
Torx® Pan Head Sems®  
Tapping Screw with Dog Point  
T15 Drive  
Washer Outer Diameter: 17mm (11/16")  
GM 2007 - On

UNIT PACKAGE: 50



**22104**

(Ford: N801169-S900)

Black Zinc

M4.2-1.41 x 22mm  
Hex Head Sems® Tapping Screw  
Hex Size: 5.5mm  
Washer Diameter: 16mm  
Front Bumper, Exterior Trim & Front Fender  
Ford & Lincoln 2010 - 1997

UNIT PACKAGE: 50



**19006**

Phosphate

M4.2-1.41 x 25mm (#8 x 1")  
Round Washer Head  
Pozi-Drive with Tek's® Point  
Washer Head Outer Diameter: 11mm (7/16")  
General Purpose

UNIT PACKAGE: 100



**20382**

(Not Available from O.E.M.)

Black Zinc

M4.2-1.41 x 25mm (#8 x 1")  
Torx® Pan Head Sems®  
T-15 Drive  
Washer Outer Diameter: 12mm (1/2")

UNIT PACKAGE: 50



**22081**

(GM: 11609762)

Black Zinc

M4.2-1.41 x 25mm  
Pozi-Drive Round Washer  
Head Sems® Tapping Screw  
Washer Diameter: 17mm  
Chevrolet Equinox, GMC Acadia & Terrain  
and Saturn Outlook 2007 - On

UNIT PACKAGE: 50



**18336**

Black Phosphate

M4.2-1.41 x 25mm (#8 x 1")  
Hex Head Sems®  
Washer Outer Diameter: 12mm (1/2")  
Hex: 7mm

UNIT PACKAGE: 100

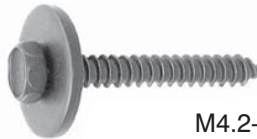

**19653**

(N811534-S61)

Black Phosphate

M4.2-1.41 x 30mm (#8 x 1-3/16")  
Hex Head Sems®  
Washer Outer Diameter: 17mm (11/16")  
Hex: 7mm  
Ford

UNIT PACKAGE: 15



**18340**

Black Phosphate

M4.8-1.61 x 15mm (#10 x 19/32")  
Phillips Truss Head  
Head Outer Diameter: 14mm (9/16")  
Nissan Bumpers

UNIT PACKAGE: 50



**17459**

Black Oxide

M4.8-1.61 x 16mm (#10 x 5/8")  
Phillips Truss Head  
Head Diameter: 11mm (7/16")  
Imports

UNIT PACKAGE: 100



**22030**

(BMW: 07-14-7-129-160)

Black Zinc

M4.8-1.61 x 16mm (#10 x 5/8")  
Hex Head Sems®  
Washer Outer Diameter: 18mm  
Hex: 8mm  
BMW 2013 - 1999

UNIT PACKAGE: 50



**22110**

(VW: N90775801,

BMW: 07146963883)

Black Zinc

M4.8-1.61 x 18mm  
Torx® Truss Head Tapping Screw  
T25 Drive  
Head Diameter: 15mm  
Audi & VW 1998 - On  
BMW 5, 6 & 7 Series 2011 - 00

UNIT PACKAGE: 25

**METRIC ITEMS**



**20259**  
 (90114-SZ3-000, 90114-SE0-000)  
 Black E-Coat  
 M4.8-1.61 x 19mm (#10 x 3/4")  
 Phillips Truss Head Sems®  
 Washer Outer Diameter: 16mm (5/8")  
 Splash Shield & General Purpose  
 Honda 1986 - On  
 UNIT PACKAGE: 25

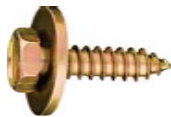

**16589**  
 Zinc & Yellow Dichromate  
 #10 x 3/4 (19mm)  
 Indented Hex Head Sems®  
 Washer Outer Diameter: 19/32"  
 Hex: 5/16" (8mm)  
 Honda, Nissan, Toyota  
 UNIT PACKAGE: 50



**21774**  
 (Mercedes-Benz: 201-990-05-36)  
 Black E-Coat  
 M4.8-1.61 x 20mm (#10 x 25/32")  
 Hex Head Sems®  
 Washer Outer Diameter: 26mm  
 Hex: 8mm  
 Front Bumper & Moulding Strip  
 Mercedes-Benz 2014 - 1993  
 UNIT PACKAGE: 25



**21865**  
 (Chrysler: 6509539-AA)  
 Phosphate  
 M4.8-1.61 x 32mm (#10 x 1-1/4")  
 Hex Head Sems® Tapping Screw  
 Washer Outer Diameter: 19mm (3/4")  
 Hex: 8mm  
 Chrysler Town & Country  
 and Dodge Ram 2014 - 09  
 UNIT PACKAGE: 50



**21746**  
 (Mitsubishi: MF453091)  
 Black Oxide  
 M5-1.59 x 11mm  
 Phillips Truss Head  
 Head Outer Diameter: 11mm  
 Interior Trim  
 Mitsubishi Galant 2008 - 2004  
 UNIT PACKAGE: 50



**21747**  
 Black Oxide  
 M5-1.59 x 11mm  
 Phillips Round Washer Head  
 Washer Head Outer Diameter: 12mm  
 Chrysler & Imports  
 UNIT PACKAGE: 50



**19251**  
 Black Zinc  
 M5-1.59 x 16mm  
 Phillips Hex Head Sems®  
 Washer Outer Diameter: 16mm  
 Hex: 8mm  
 UNIT PACKAGE: 50



**22294**  
 (Mazda: 9CF600516B)  
 Black Phosphate  
 M5-1.81 x 16mm  
 Phillips Hex Head Sems®  
 Washer Outer Diameter: 16mm  
 Hex: 8mm  
 Mazda 2, 3, 5, 6, 626, 929, CX-5, CX-7, CX-9, Miata,  
 Millenia, MPV, Mx-3, Protégé, RX-7 & RX-8 2014 - 1992  
 UNIT PACKAGE: 25



**22203**  
 (Honda: 90103-SDA-A00)  
 Black Phosphate  
 M5-1.81 x 20mm  
 Phillips Flat Head  
 Head Diameter: 13mm  
 Front & Rear Bumper  
 Honda Civic, Pilot & Ridgeline 2006 - On  
 UNIT PACKAGE: 100



**21841**  
 (Toyota: 75392-42030)  
 Black E-Coat  
 M5.2-2.0 x 20mm (#12 x 25/32")  
 Phillips Hex Head Sems®  
 Washer Outer Diameter: 12mm (1/2")  
 Hex: 8mm  
 Front Bumper Moulding  
 Toyota & Lexus 2010 - On  
 UNIT PACKAGE: 25



**21839**  
 (Toyota: 90159-A0001;  
 90159-50316)  
 Zinc  
 M5.2-2.0 x 21mm (#12 x 13/16")  
 Phillips Hex Head Sems®  
 Washer Outer Diameter: 14mm (9/16")  
 Hex: 10mm  
 Front Bumper, Bumper Stay & Radiator Grille  
 Toyota & Lexus 2000 - On  
 UNIT PACKAGE: 25



**22111**  
 (VW: N90892001, N90775001)  
 Black Zinc  
 M5-2.12 x 19mm (#12 x 3/4")  
 Torx® Truss Head Tapping Screw  
 T25 Drive  
 Head Diameter: 14mm  
 Audi, Porsche & VW 2014 - 07  
 UNIT PACKAGE: 25

**Sec. 7**

**METRIC ITEMS**



**20455**  
Black Phosphate

M5-2.12 x 20mm (#12 x 25/32")  
Phillips Truss Head  
Head Outer Diameter: 14mm  
Imports

UNIT PACKAGE: 50



**22292**  
(Nissan: 01454-N5061)  
Black Phosphate

M5.5-1.81 x 16mm (#12 x 5/8")  
Phillips Truss Head  
Head Outer Diameter: 13mm  
Fender Liner  
Nissan Cube, Murano, Pathfinder, Quest,  
Rogue, Sentra & Versa 2014 - On

UNIT PACKAGE: 25



**17461**  
Zinc & Yellow Dichromate  
M5.5-1.81 x 18mm (#12 x 45/64")  
Hex Head Sems®  
Washer Outer Diameter: 15mm (19/32")  
Hex: 8mm  
Imports

UNIT PACKAGE: 50



**21541**  
(13144822)  
Black Zinc  
M5.5 x 20mm (#12 x 25/32")  
Torx® Truss Head  
T-20 Drive  
Head Outer Diameter: 15mm (19/32")  
**Use with Auveco 21540**  
GM 2011 - On  
Saab 2003 - On

UNIT PACKAGE: 25



**21744**  
(Mitsubishi: MS452348)  
Black E-Coat  
M6-1.81 x 20mm  
Phillips Hex Head Sems®  
Washer Outer Diameter: 13mm (1/2")  
Hex: 10mm  
Bumper, Exterior Trim,  
Fender Shield and Quarter Panel  
Mitsubishi Diamante, Eclipse, Galant, Lancer,  
Mirage, Montero & 3000GT 2012 - 1991

UNIT PACKAGE: 25



**19170**  
Black Phosphate

M6.3-1.81 x 16mm (#14 x 5/8")  
Phillips Truss Head  
Head Outer Diameter: 15mm (19/32")  
Japanese Imports

UNIT PACKAGE: 50



**15776**  
(N800312-S2)  
Phosphate

M6.3-1.81 x 16mm (#14 x 5/8")  
Hex Head Sems®  
Washer Outer Diameter: 16mm (5/8")  
Hex: 8mm  
Ford

UNIT PACKAGE: 50



**12057**  
(11500994)  
Phosphate

M6.3-1.81 x 16mm (#14 x 5/8")  
Hex Head Sems®  
Washer Outer Diameter: 17mm (11/16")  
Hex: 10mm  
GM

UNIT PACKAGE: 50



**15962**  
Zinc & Yellow Dichromate  
M6.3-1.81 x 18mm (#14 x 23/32")  
Hex Head Sems®  
Washer Outer Diameter: 22mm (7/8")  
Hex: 10mm  
Honda, Nissan, Toyota

UNIT PACKAGE: 25



**13019**  
(N610959-S2)  
Phosphate

M6.3-1.81 x 19mm (#14 x 3/4")  
Hex Washer Head  
Washer Outer Diameter: 11.5mm (29/64")  
Hex: 8mm  
Ford

UNIT PACKAGE: 50



**20556**  
Black Zinc

M6.3-1.81 x 20mm (#14 x 25/32")  
Phillips Hex Head Sems®  
Washer Outer Diameter: 16mm (5/8")  
Hex: 10mm  
Imports

UNIT PACKAGE: 50



**METRIC ITEMS**

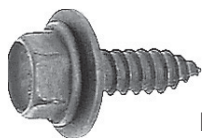

**12351**  
(11505022)  
Black Phosphate  
M6.3-1.81 x 20mm (#14 x 25/32")  
Hex Washer Head Sems®  
Washer Outer Diameter: 17mm (11/16")  
Hex: 10mm  
GM

UNIT PACKAGE: 50



**16828**  
Zinc & Yellow Dichromate  
M6.3-1.81 x 20mm (#14 x 25/32")  
Hex Head Sems®  
Washer Outer Diameter: 18mm (45/64")  
Hex: 10mm  
Honda, Nissan, & Toyota

UNIT PACKAGE: 25



**20557**  
Black Zinc  
M6.3-1.81 x 20mm (#14 x 25/32")  
Phillips Hex Head Sems®  
Washer Outer Diameter: 20mm (25/32")  
Hex: 10mm  
Imports

UNIT PACKAGE: 50



**12339**  
(11500996, 11505023)  
Phosphate  
M6.3-1.81 x 25mm (#14 x 1")  
Hex Head Sems®  
Washer Outer Diameter: 17mm (21/32")  
Hex: 10mm  
GM

UNIT PACKAGE: 50



**12354**  
(11500997)  
Phosphate  
M6.3-1.81 x 30mm (#14 x 1-3/16")  
Hex Head Sems®  
Washer Outer Diameter: 17mm (21/32")  
Hex: 10mm  
GM

UNIT PACKAGE: 50

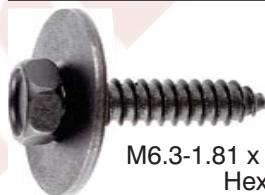

**12068**  
(11504981)  
Phosphate  
M6.3-1.81 x 30mm (#14 x 1-3/16")  
Hex Head Sems®  
Washer Outer Diameter: 24mm (15/16")  
Hex: 10mm  
GM

UNIT PACKAGE: 50



**22106**  
(Toyota: 90159-60303)  
Zinc  
M6.3-2.5 x 18mm  
Phillips Hex Head Sems® Tapping Screw  
Washer Outer Diameter: 14mm  
Hex: 10mm  
Toyota & Scion 1993 - On

UNIT PACKAGE: 25



**21838**  
(Toyota: 90159-60488)  
Zinc  
M6.3-2.5 x 24mm (#14 x 15/16")  
Phillips Hex Head Sems®  
Washer Outer Diameter: 16mm (5/8")  
Hex: 10mm  
Front Bumper, Bumper Stay, Hood and Front Fender  
Lexus CT200, ES350, HS250, IS & SC430,  
Scion and Toyota 1995 - On

UNIT PACKAGE: 25



**22295**  
(Hyundai: 12493-06207B)  
Black Phosphate  
M6.5-1.81 x 18mm  
Phillips Truss Head  
Head Outer Diameter: 16mm  
Fender Liner  
Hyundai Accent, Azera, Elantra, Entourage, Genesis,  
I30, Santa Fe, Sonata, Tiburon, Tucson, Veloster &  
Veracruz 2013 - 2005

UNIT PACKAGE: 25



**22296**  
(Hyundai: 92155-22000;  
11254-06206)  
Black Phosphate  
M6.5-1.81 x 25mm  
Phillips Truss Head  
Head Outer Diameter: 16mm  
Headlamp Assembly Mounting Screw  
Hyundai 2000 - On

UNIT PACKAGE: 25



**21837**  
(Toyota: 90159-60525)  
Black E-Coat  
M6.5-2.5 x 19mm (#14 x 3/4")  
Phillips Hex Head Sems®  
Washer Outer Diameter: 20mm (25/32")  
Hex: 10mm  
Floor Pan & Lower Back Panel Moulding, Rear Bumper  
Stay, Suspension Cross Member and Under Cover  
Toyota 1998 - On

UNIT PACKAGE: 25

**Sec. 7**

**METRIC ITEMS**

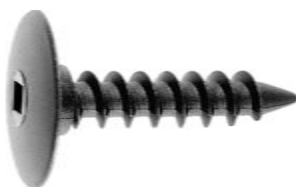

**19417**  
 (Chry: 6503819, 6503401;  
 GM: 25631448)  
 Black Nylon  
 M7.5 x 35mm  
 Square Drive Truss Head  
 Head Diameter: 22mm  
 Shoulder Diameter: 9mm  
 Foam to Bumper Fascia  
 Chrysler 1993-On  
 GM 1997 - On

UNIT PACKAGE: 15



**12350**  
 (11500086)  
 Phosphate  
 M8-2.12 x 20mm (5/16" - 12 x 25/32")  
 Hex Washer Head  
 Washer Head Outer Diameter: 16mm (5/8")  
 Hex: 13mm  
 GM

UNIT PACKAGE: 25

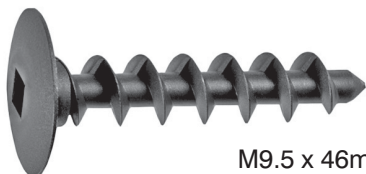

**21517**  
 (25705182)  
 Black Nylon  
 M9.5 x 46mm  
 Square Drive Truss Head  
 Head Diameter: 22mm  
 GM

UNIT PACKAGE: 25



**20970**  
 (Not Available from O.E.M.)  
 Black Nylon  
 M14 x 34mm  
 Bumper and Door  
 Insulator Nylon Screw  
 No. 3 Square Drive  
 Head Outer Diameter: 22mm  
 Fits into 12mm Hole  
 GM, Ford & Chrysler 2005 - On

UNIT PACKAGE: 25



**16986**  
 (14003784)  
 Zinc  
 M8-1.25 x 25mm  
 Stainless Steel Capped  
 Pan Head without Nuts  
 Head Diameter: 19mm  
 Shoulder Length: 3mm  
 GM

UNIT PACKAGE: 25



**11404**  
 (N14-4003)  
 Plain  
 M8-1.25 x 35mm  
 Class 4.8  
 Volkswagen Intake Manifold

UNIT PACKAGE: 25



**17559**  
 Zinc &  
 Yellow Dichromate  
 M10-1.25 x 42mm  
 Class 8.8  
 Exhaust Systems  
 Honda, Nissan & Toyota

UNIT PACKAGE: 10

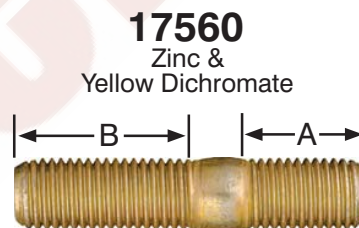

**17560**  
 Zinc &  
 Yellow Dichromate  
 M10-1.25 x 48mm  
 Dim. A: 15mm Dim. B: 25mm  
 Class 8.8  
 Exhaust Systems  
 Honda, Nissan & Toyota

UNIT PACKAGE: 10



**17596**  
 Zinc &  
 Yellow Dichromate  
 M12-1.25 x 50mm  
 Class 8.8  
 Catalytic Converter  
 Mazda

UNIT PACKAGE: 5

**METRIC ITEMS**

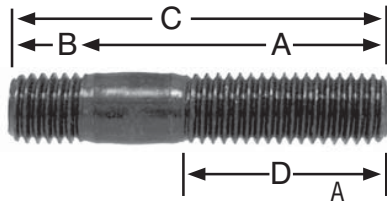

**Cylinder Head and Manifold Metric Studs**  
Grade 8 Medium Carbon Heat Treated Alloy Steel  
Regular Pitch

Auveco Part No.	Diameter & Length	B Diameter & Length	C Overall Length	D Length	Unit Pkg.
11973	6mm-1.00 x 20mm	6mm-1.00 x 7.5mm	27.5mm	18mm	10
11974	6mm-1.00 x 25mm	6mm-1.00 x 7.5mm	32.5mm	18mm	10
11980	8mm-1.25 x 20mm	8mm-1.25 x 10mm	30.0mm	16mm	10
11981	8mm-1.25 x 25mm	8mm-1.25 x 10mm	35.0mm	22mm	10
11982	8mm-1.25 x 30mm	8mm-1.25 x 10mm	40.0mm	22mm	10
11983	8mm-1.25 x 35mm	8mm-1.25 x 10mm	45.0mm	22mm	10
11984	8mm-1.25 x 40mm	8mm-1.25 x 10mm	50.0mm	22mm	10
11987	8mm-1.25 x 55mm	8mm-1.25 x 10mm	65.0mm	22mm	10
11989	10mm-1.50 x 30mm	10mm-1.50 x 12mm	42.0mm	18mm	10
11990	10mm-1.50 x 35mm	10mm-1.50 x 12mm	47.0mm	26mm	10
11991	10mm-1.50 x 40mm	10mm-1.50 x 12mm	52.0mm	26mm	10
11993	10mm-1.50 x 50mm	10mm-1.50 x 12mm	62.0mm	26mm	10
11995	10mm-1.50 x 65mm	10mm-1.50 x 12mm	77.0mm	26mm	5
11998	12mm-1.75 x 30mm	12mm-1.75 x 15mm	45.0mm	25mm	5



**Regular Pitch Metric Hex Nuts**  
DIN 934

Class 8 • Steel • Zinc Plated  
Tensile Strength: 116,000 Max.

Auveco Part No.	Size	Pitch (mm)	Hex Width	Unit Pkg.
10569	4mm	.70	7mm	25
14448	4mm	.70	7mm	50
10570	5mm	.80	8mm	25
14449	5mm	.80	8mm	50
10571	6mm	1.00	10mm	25
14450	6mm	1.00	10mm	100
10572	7mm	1.00	11mm	25
14451	7mm	1.00	11mm	50
10573	8mm	1.25	13mm	25
14452	8mm	1.25	13mm	100
10575	10mm	1.50	17mm	10
14454	10mm	1.50	17mm	50
10576	12mm	1.75	19mm	10
14455	12mm	1.75	19mm	25
14625	14mm	2.00	22mm	25
14626	16mm	2.00	24mm	25



**Fine Pitch Metric Hex Nuts**  
DIN 934

Class 8 • Steel • Zinc Plated  
Tensile Strength: 116,000 Max.

Auveco Part No.	Size	Pitch (mm)	Hex Width	Unit Pkg.
10574	8mm	1.00	13mm	25
14453	8mm	1.00	13mm	50
11277	10mm	1.00	17mm	10
14456	10mm	1.00	17mm	25
11278	10mm	1.25	17mm	10
14457	10mm	1.25	17mm	25
11279	12mm	1.25	19mm	10
14458	12mm	1.25	19mm	25
11280	12mm	1.50	19mm	10
14459	12mm	1.50	19mm	25
21426	14mm	1.50	22mm	10
14629	16mm	1.50	24mm	25



**J.I.S. Small Hex Nuts**  
J.I.S. B1181 • I.S.O. Class 8  
Steel • Heat Treated  
Zinc Plated

Auveco Part No.	Size	Pitch (mm)	Hex Width	Unit Pkg.
14796	8mm	1.25	12mm	25
17391	8mm	1.25	12mm	100
14797	10mm	1.25	14mm	15
17392	10mm	1.25	14mm	50
16617	12mm	1.25	17mm	25



**Metric Nylon Insert Lock Nuts**  
DIN 985  
Heat Treated Alloy Steel  
Zinc Plated

Auveco Part No.	Size	Pitch (mm)	Hex Width	Unit Pkg.
11049	4mm	.70	7mm	100
11051	5mm	.80	8mm	100
11053	6mm	1.00	10mm	100
11055	8mm	1.25	13mm	100
11057	10mm	1.50	17mm	100
11059	12mm	1.75	19mm	100



**Sec. 7**

**METRIC ITEMS**



Type A



Type B

**Metric Free Spinning Washer Nuts**

Auveco Part No.	Thread Size	Type	Washer O.D.	Hex Size	Height	Plating	O.E.M. No.	Unit Pkg.
<b>15325</b>	M4-0.7	B	12mm	9mm	4.5mm	Phosphate	N621900, N800466	50
<b>16883</b>	M5-0.8	B	10mm	8mm	7mm	Zinc & Yellow	N802775-S36	50
<b>15326</b>	M5-0.8	B	15mm	10mm	7mm	Phosphate	N621903	50
<b>15327</b>	M5-0.8	B	19mm	10mm	7mm	Phosphate	11504614	50
<b>19216</b>	M6-1.0	B	14mm	10mm	8mm	Phosphate	6100047	50
<b>12595</b>	M6-1.0	A	16mm	10mm	7mm	Phosphate	11505329, 11503752, N90100001	25
<b>16268</b>	Same as 12595 except for packaging							50
<b>15328</b>	M6-1.0	B	16mm	11mm	8.5mm	Phosphate	N621905	50
<b>16136</b>	M6-1.0	B	18mm	10mm	7mm	Zinc	94515340	25
<b>15329</b>	M6-1.0	B	18mm	10mm	9mm	Phosphate	6100048	50
<b>12596</b>	M6-1.0	A	19mm	11mm	9.5mm	Phosphate	11503754, 11503756	25
<b>15330</b>	M6-1.0	B	19mm	10mm	8mm	Zinc	11508275	50
<b>16774</b>	M6-1.0	B	19mm	11mm	9mm	Zinc & Yellow	N621906-S36	50
<b>15331</b>	M6-1.0	B	20mm	10mm	9mm	Phosphate	6100049	50
<b>15332</b>	M6-1.0	B	24mm	11mm	9mm	Zinc & Yellow	N621907	25
<b>15333</b>	M8-1.25	B	18mm	13mm	10mm	Phosphate	6100050	25
<b>15334</b>	M8-1.25	B	19mm	13mm	10mm	Phosphate	11501800	25
<b>15335</b>	M8-1.25	B	24mm	13mm	10.5mm	Phosphate	11503695, 11506117, N621940	25
<b>15337</b>	M10-1.5	B	24mm	15mm	13mm	Phosphate	N621942	25
<b>21001</b>	M12-1.75	B	28mm	18mm	16mm	Phosphate	N621945-S2	10



**Metric Flange Lock Nuts**



Auveco Part No.	Thread Size	Flange O.D.	Hex Size	Height	Plating	O.E.M. No.	Unit Pkg.
<b>18251</b>	M6-1.0	14mm	10mm	6mm	Zinc & Yellow		50
<b>15316</b>	M6-1.0	14mm	10mm	7.5mm	Phosphate	N620480	50
<b>11709</b>	M8-1.25	17mm	13mm	8.5mm	Zinc	11502811	50
<b>15318</b>	M10-1.5	20.5mm	15mm	13mm	Phosphate	N620482	25
<b>11708</b>	M10-1.5	21mm	15mm	11.5mm	Zinc	11502812	25
<b>14521</b>	M10-1.5	21mm	15mm	12mm	Phosphate		25
<b>14522</b>	M12-1.75	25mm	18mm	14mm	Phosphate		25
<b>14523</b>	M16-2.0	33mm	24mm	18mm	Phosphate		10

**METRIC ITEMS**



**Metric Hex Flange Nuts**



Auveco Part No.	Thread Size	Flange O.D.	Hex Size	Height	Plating	O.E.M. No.	Unit Pkg.	
<b>16880</b>	M4-.7	11mm	7mm	5mm	Black Zinc	14031900	50	
<b>17495*</b>	M4-.7	14mm	9mm	6mm	Zinc	N620391-S36	50	
<b>19309</b>	M5-.8	11.5mm	8mm	5mm	Black Oxide		50	
<b>19308</b>	M5-.8	11.5mm	8mm	5mm	Zinc	11502702	50	
<b>19205</b>	M6-1.0	14mm	10mm	6mm	Phosphate	11503745	100	
<b>20450</b>	M6.3-1.81	20mm	11mm	7mm	Zinc Organic	22516030	25	
<b>11644</b>	M8-1.25	17mm	13mm	8mm	Phosphate	11501889	25	
<b>16269</b>	Same as 11644 except for unit package quantity						11502609, 11507036	50
<b>18253</b>	M10-1.25	19mm	14mm	9mm	Zinc & Yellow		50	
<b>11645</b>	M10-1.5	21mm	15mm	10mm	Phosphate	11501850	25	
<b>20606</b>	M12-1.75	25mm	18mm	12mm	Phosphate		25	

\*with Sealer



**Metric Spin Lock Nuts with Serrations Case Hardened**



Auveco Part No.	Thread Size	Flange O.D.	Hex Size	Plating	Unit Pkg.
<b>Standard Flange</b>					
<b>16769</b>	M6-1.0	14mm	10mm	Zinc	50
<b>16830</b>	M8-1.25	17mm	12mm	Zinc	50
<b>16470</b>	M10-1.25	19mm	14mm	Zinc	25
<b>Large Flange</b>					
<b>14855</b>	M6-1.0	17mm	10mm	Phos	100
<b>14856</b>	M8-1.25	19mm	13mm	Phos	100
<b>22045</b>	M10-1.50	20mm	15mm	Zinc	25



**Nylon Coated Acorn Nuts**

Auveco Part No.	Size	Hex	Height	Unit Pkg.
<b>20570</b>	M4-0.7	10mm	11mm	15



**Metric Wing Nuts  
DIN D00213  
Zinc Plated**

Auveco Part No.	Thread Size	Unit Pkg.
<b>17010</b>	M6-1.0	25



**18531**  
(6503837)  
Black

Ziptwist Wing Nut  
Fits 6mm Stud  
Outer Diameter: 5/8"  
UNIT PACKAGE: 50



**12254**  
(11501814)  
Zinc

Metric Washer Lock Nuts  
Thread Size: M5-.8  
Flange Diameter: 14mm  
Height: 6mm  
Hex Size: 10mm  
UNIT PACKAGE: 100

**Sec. 7**

**METRIC ITEMS**



**Washer Type Metric Self-Threading Nuts**



Auveco Part No.	Stud Size	Hex Width	Washer Diameter	Finish	O.E.M. Number	Unit Pkg.
<b>16134*</b>	3mm	8mm	13.5mm	Zinc & Yellow		25
<b>12115</b>	4mm	9mm	15mm	Zinc	11502549	100
<b>12116</b>	5mm	10mm	15mm	Phosphate	11508900	50
<b>12253</b>	5mm	10mm	15mm	Phosphate	11501835, 10062	50
<b>19548</b>	6mm	11mm	15mm	Zinc	6100814	50
<b>16829</b>	6mm	11mm	18mm	Zinc	6100815	100
<b>12117</b>	6.3mm	11mm	18mm	Zinc	11503432	50
<b>12255</b>	6.3mm	11mm	18mm	Zinc	11501836	50
<b>15711</b>	8mm	13mm	20mm	Zinc	11502507, 11509535 11514282	100

\*With Sealer



**Metric Push-On Retainers**  
For Non-Threaded Fasteners

Auveco Part No.	Stud Size	Diameter	Finish	Unit Pkg.
<b>12118</b>	3.2mm	9.5mm	Zinc	100
<b>12119</b>	4mm	11mm	Zinc	100

**Please order items in unit package quantities and by number of pieces needed**



**Metric Pushnut Bolt Retainers**  
For Threaded Fasteners

Auveco Part No.	Thread Size	O.D.	Finish	Unit Pkg.
<b>12122</b>	M5-0.8	11mm	Zinc	100
<b>12123</b>	M6-1.0	13mm	Zinc	100
<b>14980</b>	M6-1.0	17mm	Zinc	100
<b>12124</b>	M6.3-1.0	13mm	Zinc	100
<b>12125</b>	M8-1.25	16mm	Zinc	100
<b>12259</b>	M8-1.25	24mm	Zinc	50
<b>12126</b>	M10-1.50	20mm	Phosphate	50
<b>12260</b>	M10-1.50	24mm	Zinc	100
<b>12127</b>	M12-1.75	21mm	Zinc	50
<b>16980</b>	M14-2.0	25mm	Phosphate	50

**TUBULAR TYPE NUTS**

(Listed by Stud Size)



**13227**

(113-853-615A)  
Natural Nylon

For 3mm Stud  
Fits into 4mm Hole  
Overall Length: 10mm

UNIT PACKAGE: 50



**16124**

(001-988-20-81)  
Red Nylon

For 5mm Stud  
Fits into 9mm Hole  
Overall Length: 14mm

UNIT PACKAGE: 50



**20472**

(91512-SR3-004)  
White Nylon

Tubular Nut with Sealer & Sealed End  
For 3mm Stud  
Fits into 6mm Hole  
Head Diameter: 8.5mm

UNIT PACKAGE: 10



**13170**

(5131-1-802-258)  
Natural Nylon

For 7mm Stud  
Fits into 8mm hole  
Overall Length: 20mm

UNIT PACKAGE: 50



**METRIC ITEMS**

**CAGE NUTS**



**16142**  
Zinc

Screw Size: M6-1.0  
Panel Range: 1.7mm-2.7mm

UNIT PACKAGE: 25



**20651**  
(001-990-00-91)  
Zinc & Yellow

Screw Size: M6-1.0  
Panel Range: .5mm - 1.7mm  
Center of Hole to Edge: 15mm

UNIT PACKAGE: 10

**U & J NUTS  
BY SCREW SIZE**



**13221**  
(0712-9-925-706)  
Zinc

Screw Size: 2.9mm  
Panel Range: .5mm-1.5mm  
Center of Hole to Edge: 6mm

UNIT PACKAGE: 50



**20649**  
Zinc

Screw Size: 3.5mm (#6)  
Panel Range: .5mm - 1.5mm  
Center of Hole to Edge: 8mm

UNIT PACKAGE: 50



**13224**  
(000-994-04-45)  
Zinc

Screw Size: 4.2mm (#8)  
Panel Range: .5mm-1.7mm  
Center of Hole to Edge: 8mm

UNIT PACKAGE: 50



**13223**  
(BMW: 0712-9-925-708;  
Mercedes: 000-994-25-45)  
Zinc

Screw Size: 4.2mm (#8)  
Panel Range: 3mm-4mm  
Center of Hole to Edge: 7mm

UNIT PACKAGE: 50



**13225**  
Zinc

Screw Size: 4.2mm (#8)  
Panel Range: .5mm-2.5mm  
Center of Hole to Edge: 8mm

UNIT PACKAGE: 50



**13216**  
Zinc

Screw Size: 4.8mm (#10)  
Panel Range: .9mm-2mm  
Center of Hole to Edge: 8mm

UNIT PACKAGE: 25



**20650**  
(123-994-08-45)  
Zinc

Screw Size: 4.2mm (#8)  
Panel Range: .5mm-2.5mm  
Center of Hole to Edge: 14mm

UNIT PACKAGE: 25



**21017**  
(Nissan: 76882-0M000)  
White Nylon

Screw Size: 4.8mm(#10)  
Panel Range: Up to 1.5mm  
Center of Hole to Edge: 8mm

UNIT PACKAGE: 15



**13215**  
Zinc

Screw Size: 4.8mm(#10)  
Panel Range: .8mm-1.7mm  
Center of Hole to Edge: 11mm

UNIT PACKAGE: 50



**13218**  
Zinc & Yellow

Screw Size: 4.8mm(#10)  
Panel Range: .5mm-1.7mm  
Center of Hole to Edge: 7mm

UNIT PACKAGE: 50



**22114**  
(BMW: 07129904150)  
Zinc Finish

U Type Nut  
Screw Size: M4.8 (#10)  
Panel Range: 2.3mm - 3.5mm (.090"-.138")  
Center of Hole to Edge: 8.5mm  
BMW 2011 - 1992

UNIT PACKAGE: 25

Sec. 7

# METRIC ITEMS U & J NUTS BY SCREW SIZE



**14750**  
Black Nylon

Screw Size: 4.8mm (#10)  
Panel Range: Up to 1mm  
Center of Hole to Edge: 11mm

UNIT PACKAGE: 15

**19669**

Same as 14750 except for unit package quantity

UNIT PACKAGE: 25

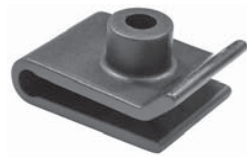

**17993**  
Black Nylon

Screw Size: 4.8mm (#10)  
Panel Range: Up to 3mm  
Center of Hole to Edge: 14mm

UNIT PACKAGE: 10



**19735**  
(Nissan: 63848-35F00)  
Black Nylon

Screw Size: 4.8mm (#10)  
Panel Range: Up to 2mm  
Center of Hole to Edge: 8mm

UNIT PACKAGE: 15



**21359**  
(Toyota: 53879-17020)  
Black Nylon

Screw Size: M4.8 (#10)  
Panel Range: Up to 2mm  
Center of Hole to Edge: 10mm

UNIT PACKAGE: 10



**21616**  
(Toyota: 76647-42010)  
Black Nylon

Screw Size: M4.8 (#10)  
Panel Range: Up to 2mm  
Center of Hole to Edge: 7mm

UNIT PACKAGE: 15



**21540**  
(GM: 24449408)  
Orange Nylon

Screw Size: M5.5 (#12)  
Panel Range: Up to 2mm (5/64")  
Center of Hole to Edge: 12mm (15/32")  
**Use with Auveco 21541**

UNIT PACKAGE: 25



**21613**  
(Toyota: 53879-20020)  
Black Nylon

Screw Size: M5.5 (#12)  
Panel Range: Up to 2mm  
Center of Hole to Edge: 11mm

UNIT PACKAGE: 15



**13162**  
Zinc

Screw Size: 5.6mm  
Panel Range: 1.2mm-2.0mm  
Center of Hole to Edge: 10mm

UNIT PACKAGE: 50



**17193**  
(Nissan: 01241-00551, 63848-D0100)  
Nylon

Screw Size: 5.6mm (#12)  
Panel Range: Up to 1mm  
Center of Hole to Edge: 9mm

UNIT PACKAGE: 15



**17385**  
(Nissan: 63848-D4000)  
Black Nylon

Screw Size: 5.6mm (#12)  
Panel Range: Up to 2mm  
Center of Hole to Edge: 9mm

UNIT PACKAGE: 10



**20956**  
(Toyota: 90467-05114)  
Black Nylon

Screw Size: 5.5mm (#12)  
Panel Range: Up to 1mm  
Center of Hole to Edge: 14mm

UNIT PACKAGE: 10

## METRIC ITEMS U & J NUTS BY SCREW SIZE



### 21614

(Toyota: 90467-05128)  
White Nylon

Screw Size: M6 (#14)  
Panel Range: Up to 2mm  
Center of Hole to Edge: 12mm

UNIT PACKAGE: 15



### 21378

(Hyundai: 86825-28000)  
Black Nylon

Screw Size: M6 (#14)  
Panel Range: Up to 1.5mm  
Center of Hole to Edge: 8mm

UNIT PACKAGE: 25



### 21615

(Toyota: 90467-A0018,  
90467-05081)  
Maroon Nylon

Screw Size: M6 (#14)  
Panel Range: Up to 2mm  
Center of Hole to Edge: 12mm

UNIT PACKAGE: 15



### 13220

(Mercedes: 000-994-09-14;  
Volvo: 946-418; Opel: 20-72-175)  
Zinc & Yellow

Screw Size: 6.5mm (#14)  
Panel Range: .7mm-1.5mm  
Center of Hole to Edge: 13mm

UNIT PACKAGE: 50

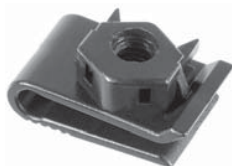

### 21459

(Nissan: 01241-00881)  
Black Nylon with Captive Metal

Hex Nut  
Thread: M6 - 1.0  
Panel Range: Up to 4mm  
Center of Hole to Edge: 14mm

UNIT PACKAGE: 10



### 14276

(Toyota: 53879-22010)  
Black Nylon

Screw Size: 6.3mm (#14)  
Panel Range: Up to 1mm  
Center of Hole to Edge: 15mm

UNIT PACKAGE: 15

## LOOKING FOR OIL DRAIN PLUGS?

Flip over to pages 275-282 to find all of Auveco's Oil Drain Plugs

You can also find all oil drain plugs at [www.auveco.com](http://www.auveco.com)

With our new site plugs can be found by part or OEM number, car make or within the oil drain plug section. You will also be able to search by color, size and other item attributes.



## Sec. 7

## METRIC ITEMS



**Metric Extruded U-Nuts**  
Fold Over Nuts

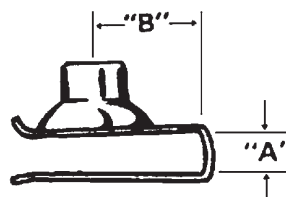

Auveco Part No.	Thread Size	"A" Panel Range		"B" Foldover Clear		Finish	O.E.M. No.	Unit Pkg.
		mm	Inches	mm	Inches			
<b>18337</b>	M4-.7	0.60-3.80	1/32-5/32	9.5	3/8	Zinc Organic	11500654, N623330-S2	50
<b>11625</b>	M4-.7	0.80-4.00	1/32-5/32	13.5	17/32	Phosphate	11500655	50
<b>20339</b>	M4.2-1.41*	0.50-2.00	1/32-5/64	10	25/64	Zinc Organic	11516397	50
<b>21040</b>	M4.2-1.41*	0.65-3.80	1/32-5/32	9.5	3/8	Zinc Organic	11513599	25
<b>22074</b>	M 4.2-1.41*	0.65-3.80	1/32-5/32	15		Zinc Organic	11515638	25
<b>22113</b>	M5-.8	0.45-1.5	1/64-1/16	11.5		Zinc Finish	51127070202, N90168602	25
<b>18338</b>	M5-.8	0.60-3.80	1/32-5/32	11	7/16	Phosphate	11505596, N623331-S2	50
<b>11626</b>	M5-.8	0.80-4.00	1/32-5/32	15.8	5/8	Phosphate	11500657	50
<b>16846</b>	M6-1.0*	0.80-4.00	1/32-5/32	12	15/32	Phosphate	6502152	50
<b>16842</b>	M6-1.0	3.40-6.30	9/64-1/4	13.5	17/32	Phosphate	11504047, N802331-S53	25
<b>18449</b>	M6-1.0*	0.80-4.00	1/32-5/32	13.5	17/32	Phosphate	6101308	50
<b>11864</b>	M6-1.0	0.80-4.00	1/32-5/32	13.5	17/32	Phosphate	11503714, 11503716	50
<b>12669</b>	M6-1.0	0.80-4.00	1/32-5/32	13.5	17/32	Phosphate	1016937, 12337917, 11503957, N623332-S2, -S53 & S-100 W520822-S426	25
<b>22105</b>	M6-1.0	2.00-4.00	5/64-5/32	14.5	9/16	Zinc	90675-SA5-003	25
<b>12666</b>	M6-1.0	3.40-6.30	9/64-1/4	14.5	9/16	Zinc Organic	11504978	25
<b>20416</b>	M6-1.0	2.00-5.00	5/64-3/16	14.5	9/16	Zinc Organic	11516372	25
<b>12575</b>	M6-1.0	0.80-4.00	1/32-5/32	19.5	25/32	Phosphate	11503715	25
<b>16322</b>	M6-1.0	1.00-2.50	3/64-3/32	19.5	25/32	Phosphate	14040999	50
<b>19480</b>	M6-1.0	4.30-5.60	11/64-7/32	21.0	13/16	Phosphate	N805889-S100	15
<b>11627</b>	M6.3-1.0	0.80-4.00	1/32-5/32	13.5	17/32	Phosphate	11502785	25
<b>11628</b>	M6.3-1.0	0.80-4.00	1/32-5/32	13.5	17/32	Phosphate	11500658	25
<b>12667</b>	M8-1.25	1.50-5.50	1/16-7/32	14.5	9/16	Zinc Organic	11503455, 11504288	25
<b>11629</b>	M8-1.25	0.80-4.00	1/32-5/32	14.5	9/16	Phosphate	11500660, 11502617, N623333-S2	25
<b>11630</b>	M8-1.25	0.80-4.50	1/32-11/64	20	13/16	Phosphate	11500661, 11503317, N623343-S2	25
<b>19644</b>	M8-1.25	1.70-5.50	1/16-7/32	28.5	1-1/8	Phosphate	10084751	15
<b>18401</b>	M8-1.25*	4.00-7.00	5/32-9/32	21	13/16	Black Phosphate	N801117-S10	25
<b>11631</b>	M10-1.50	1.00-6.00	3/64-15/64	19	3/4	Phosphate	11500662	25
<b>18339</b>	M10-1.50	1.50-5.50	1/16-7/32	28	1-3/32	Zinc Organic	11500663, N623344-S2	25

\*Locking Feature

# METRIC ITEMS



## Metric Flat Washers DIN 125



Auveco Part No.	Screw Size	Inner Diameter	Outer Diameter	Thickness	Finish	Unit Pkg.
10577	4mm	4.3mm	9mm	0.8mm	Zinc	50
10578	5mm	5.3mm	11mm	1mm	Zinc	50
10579	6mm	6.4mm	12mm	1.5mm	Zinc	50
17393	6mm	6.4mm	12mm	1.5mm	Zinc	100
16763	6mm	6.4mm	12mm	1.5mm	Zinc	100
10580	7mm	7.4mm	14mm	1.5mm	Zinc	50
10581	8mm	8.4mm	15.8mm	2mm	Zinc	25
17394	8mm	8.4mm	15.8mm	2mm	Zinc	100
16764	8mm	8.4mm	15.8mm	1.5mm	Zinc & Yellow	100
10582	10mm	10.5mm	21mm	2mm	Zinc	25
17395	10mm	10.5mm	21mm	2mm	Zinc	100
10583	12mm	13mm	24mm	2.5mm	Zinc	25
14632	14mm	15mm	28mm	2.5mm	Zinc	50
14633	16mm	17mm	30mm	3mm	Zinc	50
14634	20mm	21mm	37mm	3mm	Zinc	50



## Metric Lock Washers DIN 127 Spring Steel • Zinc Plated

Auveco Part No.	Screw Size	I.D.	O.D.	Thick-ness	Unit Pkg.
10584	4mm	4.1mm	7.4mm	0.9mm	50
10585	5mm	5.1mm	9.0mm	1.2mm	50
10586	6mm	6.1mm	11.5mm	1.6mm	50
17396	6mm	6.1mm	11.5mm	1.6mm	100
10587	7mm	7.1mm	12.2mm	1.6mm	50
10588	8mm	8.2mm	14.4mm	2mm	50
17397	8mm	8.2mm	14.4mm	2mm	100
10589	10mm	10.2mm	17.5mm	2.2mm	50
17398	10mm	10.2mm	17.5mm	2.2mm	100
10590	12mm	12.2mm	20.3mm	2.5mm	25
14636	16mm	16.2mm	27.4mm	3.5mm	50
14637	20mm	20.2mm	33.6mm	4mm	50



## Metric Spring Washers DIN 137 Spring Steel • Zinc Plated

Auveco Part No.	Screw Size	I.D.	O.D.	Thick-ness	Unit Pkg.
10591	4mm	4.3mm	8mm	0.5mm	50
10592	5mm	5.3mm	10mm	0.5mm	50
10593	6mm	6.4mm	11mm	0.5mm	50
10595	8mm	8.4mm	15mm	0.8mm	50
10596	10mm	10.5mm	18mm	1.0mm	25



## Metric Copper Washers DIN 7603

Auveco Part No.	Screw Size	Inner Diameter	Outer Diameter	Thickness	Unit Pkg.
14866	8mm	8.2mm	11.8mm	0.8mm	50
14867	10mm	10.2mm	15.8mm	0.8mm	50
14868	12mm	12.2mm	17.8mm	1.4mm	25
14869	14mm	14.2mm	17.8mm	1.4mm	25
14870	14mm	14.2mm	19.8mm	1.4mm	25
14871	16mm	16.2mm	19.8mm	1.4mm	25

**Sec. 7**

**METRIC ITEMS**

For Actual Size Illustrations, Refer to Pages 185 - 186



**Retaining Rings - Basic Internal**

**DIN 472 - 1300**

Groove required in Bore  
Phosphate & Oil Finish



Auveco Part No.	Shaft Diameter		Groove Diameter		Groove Width		Unit Pkg.
	mm	Inches	mm	Inches	mm	Inches	
11486	26	1.024	27.2	1.072	1.30	.051	50
11488	30	1.181	31.4	1.237	1.30	.051	50
11489	32	1.260	33.7	1.328	1.30	.051	50
11490	35	1.378	37.0	1.457	1.60	.063	50
11491	40	1.575	42.5	1.675	1.85	.073	25
11492	42	1.654	44.5	1.753	1.85	.073	25
11494	52	2.047	55.0	2.165	2.15	.085	25
11495	62	2.441	65.0	2.559	2.15	.085	10



**Retaining Rings - Basic External**

**DIN 471 - 1400**

Groove required on Shaft  
Phosphate & Oil Finish



Auveco Part No.	Shaft Diameter		Groove Diameter		Groove Width		Unit Pkg.
	mm	Inches	mm	Inches	mm	Inches	
11500	10.0	.394	9.6	.378	1.10	.043	100
11501	12.0	.472	11.5	.452	1.10	.043	100
11502	15.0	.591	14.3	.563	1.10	.043	100
11503	17.0	.670	16.2	.637	1.10	.043	50
11505	25.0	.985	23.9	.941	1.30	.051	50
11506	30.0	1.182	28.6	1.126	1.60	.063	50
11507	35.0	1.378	33.0	1.299	1.60	.063	50



**Retaining Rings - E Type**

**DIN 6799 - 1500**

Phosphate & Oil Finish



Auveco Part No.	Shaft Diameter		Groove Diameter		Groove Width		Unit Pkg.
	mm	Inches	mm	Inches	mm	Inches	
11513	1.4	.055	1.2	.047	0.34	.0134	100
11514	2.0	.079	1.5	.059	0.44	.0173	100
11515	2.5	.098	1.9	.075	0.54	.0213	100
11516	3.0	.118	2.3	.091	0.64	.0252	100
11517	4.0	.157	3.2	.126	0.64	.0252	100
11518	5.0	.197	4.0	.157	0.74	.0291	100
11519	6.0	.236	5.0	.197	0.74	.0291	100
11520	7.0	.276	6.0	.236	0.74	.0291	100
11521	8.0	.315	7.0	.276	0.94	.0370	100
11523	10.0	.394	9.0	.354	1.15	.0453	100
11527	20.0	.787	19.0	.748	1.78	.0700	50



# METRIC ITEMS

## Metric Grease Fittings

(Available in Large Bulk Quantities)



6mm-1.00, Straight  
DIN 71412 (VW: N185151)  
Overall Length: 14mm  
Ball Check, Plated  
**Ref No. 8601**

- 11097** Unit Package: 5
- 15122** Unit Package: 50
- 15123** Unit Package: 100
- 15426** Unit Package: 1000



8mm-1.00, Straight  
DIN 71412 (VW: N185161)  
Overall Length: 15mm  
Ball Check, Plated  
**Ref No. 8901**

- 11098** Unit Package: 5
- 15124** Unit Package: 50
- 15125** Unit Package: 100



8mm-1.25, Straight  
Overall Length: 15mm  
Ball Check, Plated  
**Ref No. 9201**

- 11778** Unit Package: 10
- 15138** Unit Package: 50
- 15139** Unit Package: 100
- 15434** Unit Package: 1000



10mm-1.00, Straight  
DIN71412 (VW: N185301)  
Overall Length: 15mm  
Ball Check, Plated  
**Ref No. 9301**

- 11100** Unit Package: 5
- 15128** Unit Package: 50
- 15129** Unit Package: 100



10mm-1.5 Straight  
Overall Length: 15mm  
Ball Check  
**Ref No. 9501**

- 17555** Unit Package: 50



6mm-1.00, 45°  
Overall Length: 22mm  
Ball Check, Plated  
**Ref No 7045**

- 11775** Unit Package: 10
- 15132** Unit Package: 50
- 15133** Unit Package: 100
- 15431** Unit Package: 1000



8mm-1.00, 45°  
Overall Length: 23mm  
Ball Check, Plated  
**Ref No. 7445**

- 11777** Unit Package: 10
- 15136** Unit Package: 50
- 15137** Unit Package: 100



8mm-1.25, 45°  
Overall Length: 23mm  
Ball Check, Plated  
**Ref No. 7545**

- 11779** Unit Package: 10
- 15140** Unit Package: 50
- 15141** Unit Package: 100



10mm-1.00, 45°  
Overall Length: 23mm  
Ball Check, Plated  
**Ref No.9345**

- 15067** Unit Package: 25
- 15098** Unit Package: 100
- 15099** Unit Package: 250



6mm-1.00, 90°  
Overall Length: 18mm  
Ball Check, Plated  
**Ref No.7090**

- 11776** Unit Package: 10
- 15134** Unit Package: 50
- 15135** Unit Package: 100



8mm-1.00, 90°  
DIN 71412 (VW: N18 511 2)  
Overall Length: 18mm  
Ball Check, Plated  
**Ref No. 7940**

- 11099** Unit Package: 5
- 15126** Unit Package: 50
- 15127** Unit Package: 100



8mm-1.25, 90°  
Overall Length: 18mm  
Ball Check, Plated  
**Ref No. 7590**

- 11780** Unit Package: 10
- 15142** Unit Package: 50
- 15143** Unit Package: 100



10mm-1.00, 90°  
DIN 71412 (VW: N18 510 1)  
Overall Length: 19mm  
Ball Check, Plated  
**Ref No. 9390**

- 11101** Unit Package: 5
- 15130** Unit Package: 50
- 15131** Unit Package: 100

## Stainless Steel Grease Fittings with Ball Check

303 Series Body · 420 Series Ball · 302 Series Spring



**17156**  
**Ref. No. 8058**

8mm-1.00, Straight  
Overall Length: 15mm

UNIT PACKAGE: 5

**Sec. 7**

**METRIC ITEMS**



Concave Type



Cup Type

**Metric Expansion Plugs**  
Zinc Plated

Auveco Part No.	Size	Type	Unit Pkg.
11876	18.0mm	Cup	25
11877	20.0mm	Cup	25
11878	22.0mm	Cup	25
11879	25.0mm	Cup	25
11881	30.0mm	Cup	25
11884	35.0mm	Cup	10
11886	38.0mm	Cup	10
11888	40.3mm	Cup	10
11895	49.5mm	Cup	10
11896	50.0mm	Cup	10
11899	35.0mm	Concave	25

**Metric Cotter Pins**  
ASME B18.8.6M • Steel



Auveco Part No.	Diameter	Length	Unit Pkg.
10553	2mm	18mm	100
10554	2mm	20mm	100
10556	2.5mm	25mm	100
10557	3.2mm	20mm	100
10558	3mm	25mm	100
10559	3mm	30mm	100
10560	3mm	35mm	50
10562	4mm	30mm	50
10564	4mm	40mm	50
10566	5mm	35mm	25
10567	5mm	40mm	25
10568	5mm	45mm	25

For an assortment of Metric Cotter Pins, see Fix-Kit No. 6158 in the green pages.

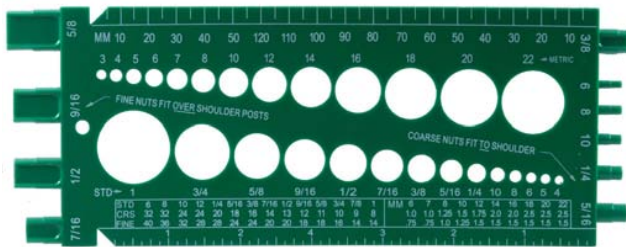

**21152**

U.S.S., S.A.E. & Metric Bolt and Nut Gauge. Excellent for sizing bolts, screws, nuts (USS, SAE, and Metric) and twist drills. Determine the bolt diameter by pushing the bolt through the sizing holes, as well as, gauges hex nuts and washers (USS & SAE) size. Metric hex nuts and washers can be measured by holding them under the metric holes.

The back of the gauge includes a feature for measuring U.S. and Metric thread pitch. Special notches on the front of the tool allow you to measure flat head metal and wood screws.

Made of sturdy, light weight green plastic that resists water, alcohol, oil and grease.

UNIT PACKAGE: 1

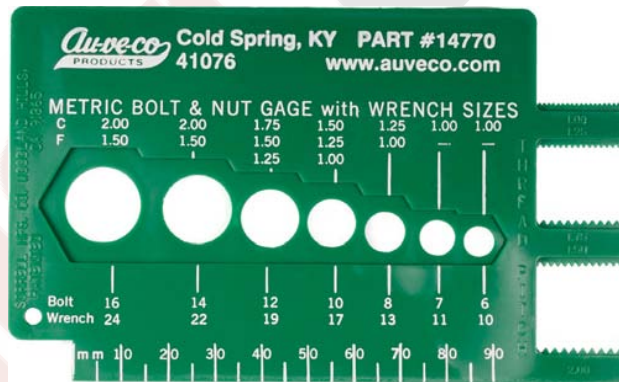

**14770**

Metric Bolt & Nut Gauge

Determine the diameter of the bolts by pushing them through the holes. Measure the hex head of bolts and screws or the "across the flat" dimension of hex nuts in the recesses around the holes (listed as wrench size).

Right-hand side of tool measures thread pitch (1.00, 1.50, 1.75 & 2.00)

UNIT PACKAGE: 1

**Thread Pitches**

Approximate threads per inch for Metric Screws, Bolts and Nuts

Diameter in mm	3	4	5	6	7	8	10	12	14	16
Diameter in Inch	.118	.157	.197	.236	.276	.315	.394	.472	.551	.630
Standard Pitch mm	.5	.7	.8	1.0	1.0	1.25	1.5	1.75	2.0	2.0
Approx. Threads/Inch	51	36	32	25	25	20	17	14	12	12
Fine Pitch mm						1.0	1.25	1.5	1.5	1.5
Approx. Threads/Inch						25	20	17	17	17
Extra Fine Pitch mm							1.0	1.25	1.25	1.25
Approx. Threads/Inch							25	20	20	20