

10" Single Handle Wall Lavatory Set w/ Lever Handle

220-16-10



PRODUCT FEATURES

- Style: Transitional
- Collection: Works
- Temperature Controlled By Handles
- Lever Handle
-
-

TECHNICAL DETAILS

ADA Compliance: No
 Drain Assembly Material: Brass
 Fitting Hole Diameter: 1 1/8"
 Number of Holes: Two Hole
 Number of Handles: One
 Handle Turn Angle: Quarter Turn
 Spout Reach: 10"
 Installation Type: Wall Mounted
 Primary Material: Brass
 Valve Material: Ceramic
 Flow Restriction: 1.2 gpm
 Water Pressure Maximum: 85 PSI
 Water Pressure Minimum: 20 PSI
 Water Pressure Recommended: 60 PSI

PRODUCT DIMENSIONS

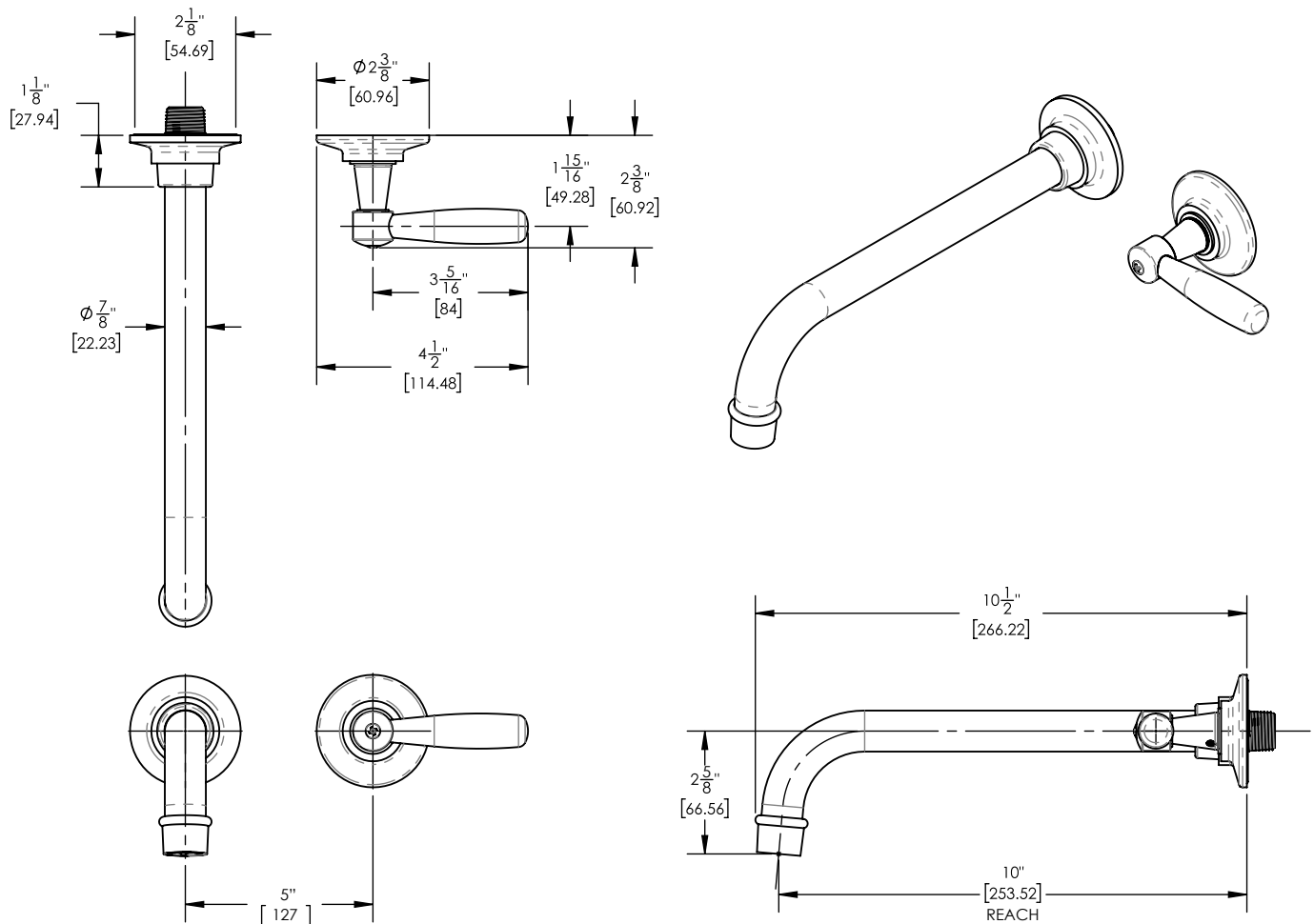

www.phylrich.com

1261 Logan Avenue, Costa Mesa, California 92626.
 Phone: 714.361.4800 Fax: 714.617.3120



CODES & STANDARDS

ASME A112.181/ CSA B1251, ASME 112.18.2/ CSA B125.2, ANSI NSF, CEC

WARRANTY

Mechanical Warranty: 10 Years from date of purchase.
 Finish Warranty: See catalog for further information.

Rev-