

Pressure Balance Shower Set

184-21



PRODUCT FEATURES

- Style: Contemporary
- Collection: Diama
- Temperature Controlled By Pressure Balance
- Blade Handle
-
-

TECHNICAL DETAILS

Access Hole Diameter: 4 1/2"
 Handle Turn Angle: 115°
 Installation Type: Wall Mounted
 Primary Material: Brass
 Valve Material: Ceramic
 Flow Restriction: 1.8 gpm
 Water Pressure Maximum: 85 PSI
 Water Pressure Minimum: 20 PSI
 Water Pressure Recommended: 60 PSI

PRODUCT DIMENSIONS

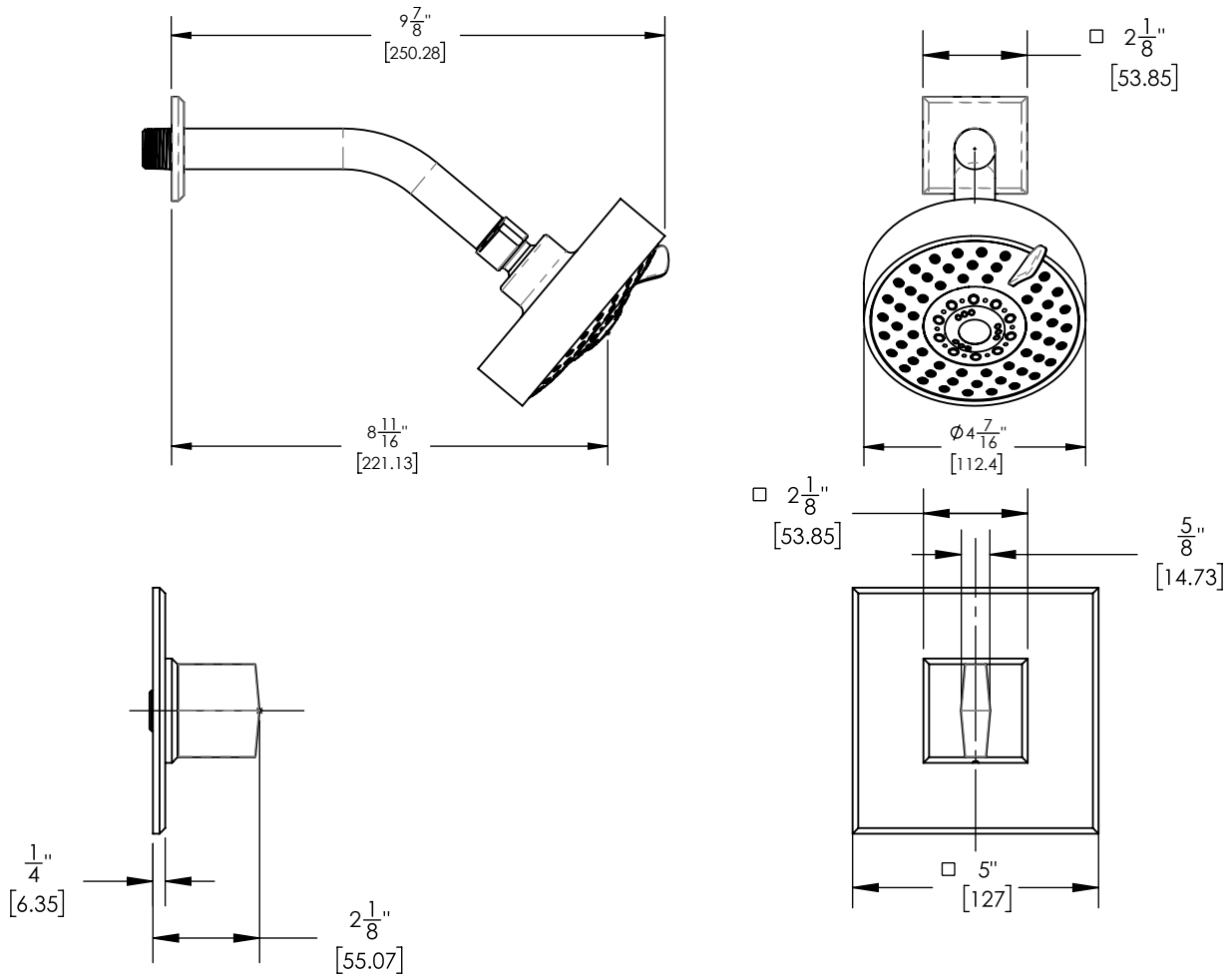

www.phylrich.com

1261 Logan Avenue, Costa Mesa, California 92626.
 Phone: 714.361.4800 Fax: 714.617.3120



CODES & STANDARDS

ASME A112.181/CSA B1251, ASME 112.18.2/CSA B125.2, ANSI NSF, CEC

WARRANTY

Mechanical Warranty: 10 Years from date of purchase.
 Finish Warranty: See catalog for further information.

Rev-