

1-132

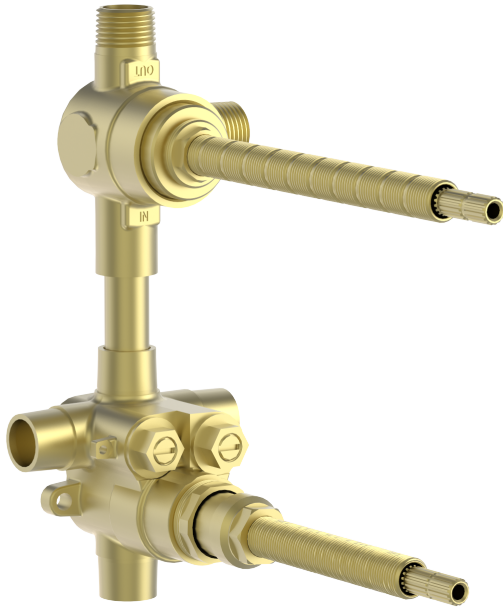

■ **PRODUCT FEATURES**

- Male 1/2" NPT inlets and outlets
- Factory temperature setting = 100°F (38°C)
- Temperature range = 52° to 118°F (11°-48°C)
- Temperature hot supply = 149° to 180°F (65°-82°C)
- Temperature cold supply = 50° to 72°F (10°-22°C)
- Temperature stability = ±32°F (0°C)

■ **TECHNICAL DETAILS**

ADA Compliance: No
 Primary Material: Brass

■ **PRODUCT DIMENSIONS**

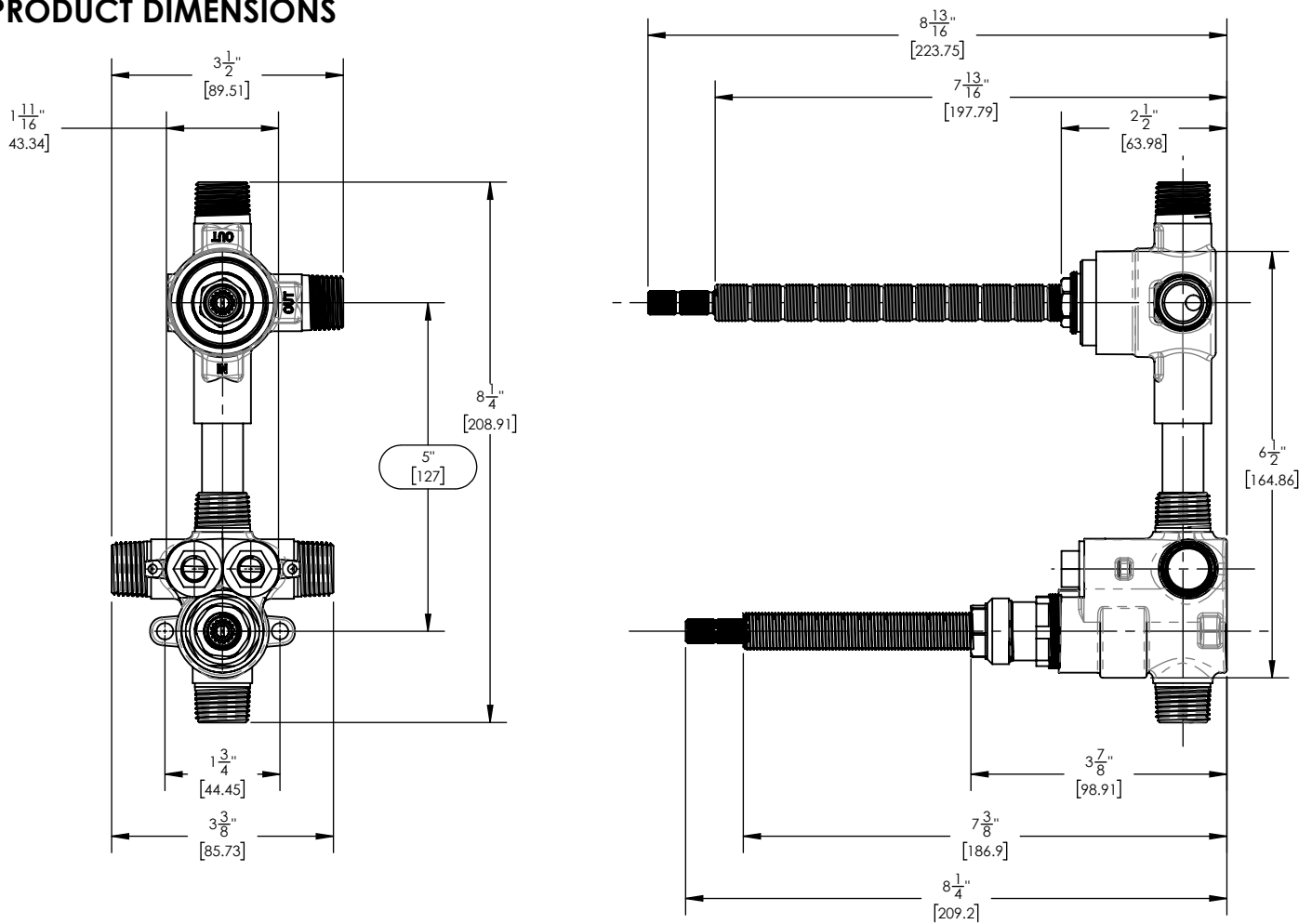

www.phylrich.com

1261 Logan Avenue, Costa Mesa, California 92626.
 Phone: 714.361.4800 Fax: 714.617.3120



CODES & STANDARDS

ASME A112.181/ CSA B1251, ASME 112.18.2/ CSA B125.2, ANSI NSF, CEC

WARRANTY

Mechanical Warranty: 10 Years from date of purchase.
 Finish Warranty: See catalog for further information.

Rev-