



Electrical Specifications

Input

Input Voltage (VAC)	120V-277V (+/- 10%)	
Frequency Range (Hz)	50 - 60 Hz (+/- 10%)	
	120V	277V
Input Current (A)	0.52	0.23
THD @ Full load	<10%	<20%
Power Factor @ Full load	>0.9	>0.9
Efficiency @ Full load	≥88%	≥89%
Inrush Current (Apk, T@10% of Apk)	1.33, 57μs	2.66, 46μs

Output

Output Current (mA)	400-1400mA (1mA step) Default 1050mA
Output Voltage (VDC)	10-55VDC
Output Ripple Current	<20% @ 1400mA
Max. Output Power (W)	50W
LED Power-Up Time	<1sec
Load Regulation	<5%
Line Regulation	<5%
Over Voltage Protection	Yes, non-latching
Over Load Protection	Yes, non-latching
Output Short-Circuit Protection	Yes, non-latching
Over Temperature Protection	Foldback at 110°C

General Information

Item Number	*2743X3 (57452) & *2743X7 (57456)
Type	Constant Current, Class2
Output Power	50W (Max.)
Programming Tool	*274A17 (51645) & *2747CR/*2743V1 (51647/ 51648)
Software	Download
Programmable Features	Output current Dimming level Dim-to-off, Soft Start LED thermal protection Auxiliary output voltage Constant lumen output End-of-life indicator

Find (NAED) as cross reference for new item number i.e. *12345

Environmental Specifications

Ambient Operating Temperature	-30°C to 50°C
Case Temperature (Tc)	85°C Max ¹ 75°C - (50kHrs)
Max. Storage Temp.	70°C
Max. Relative Humidity (%)	85% non-condensing
Transient Protection	NEMA SSL 1 - 2010 Non-Roadway 2.5KV
UL Rating	Dry & Damp
UL File number	E320395
EMI Compliance	FCC Part 15 Class A
Sound Rating	Class A

¹ - Warranty applicable only at 75°C

Architectural Dimming Features*

Synchronized On/Off & Dimming	Included
True 1% Dimming	Included
DIM to OFF	Included
Dimming Interface Protection	Included

*A complete description of OPTOTRONIC Driver Architectural Dimming Features can be found on page 8.

Dimming

Dimming Control	0 - 10V (Isolated)
Dimming Range	1-100%
Dimming Type	Analog
Dimming Input Isolation	2.5kV
Source/Sink Current	0.2mA max
Dim-to-Off OFF/ON Threshold	0.7V/1V
Stand-by Power (max)	1.4W(120V); 1.7W(277V)
Dimming Interface Protection ²	Yes, 120-277Vac

² - Driver will foldback to 30% of programming output level if AC line voltage is connected across DIM+/- terminals.
CAUTION: More than one power supply present.
Compliant with ANSI C137.1

Auxiliary Output (Model: *2743X7 (57456) only)

Output Voltage (VDC)	12/20/24V ³ (configurable)
Max Output Power (W)	1W
Voltage Regulation	±10%

³ - Default Vaux is 12V

LED thermal protection (NTC)

NTC Value Active Range	≤25kΩ
Temperature Derating Start	User defined

External NTC cannot leave the fixture.
The PRG/ NTC control circuit terminals or lead wires are not isolated.
NTC must be connected if LED Thermal Protection feature is used.



Wiring Diagram

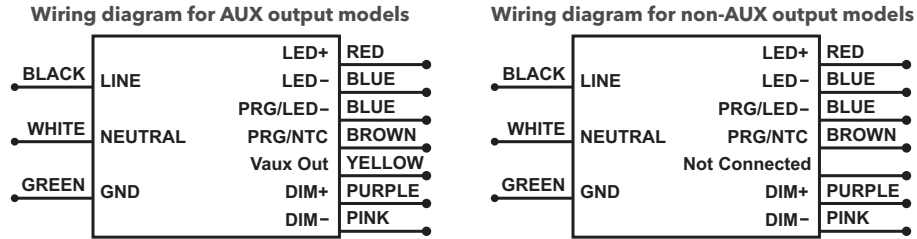

Note: The Vaux Out (YELLOW) and LED- (BLUE) will provide the DC Auxiliary output. Yellow is "+ve" polarity and blue is "-ve" polarity.

Note: Maximum suggested remote mounting distance is 16 feet.

Note: Use solid copper wire only: 16-20 AWG. Strip all wires as such:

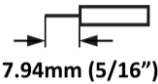

Note: For wiring the output ports for the LED load, Vaux and DIM wire, 16 to 22 AWG is acceptable for use. For more detailed information and requirements, consult the light engine information and or information pertaining to the light engine connectors.

Key Application Notes

- Dim-to-off and Soft Start are programmable (enable/disable) features. The default mode for both features is disabled for out-of-the-box products. If these features are required, they must be enabled in the programming software.
- If LED Thermal Protection feature is used, a NTC thermistor must be connected to the driver.

Mechanical Diagram

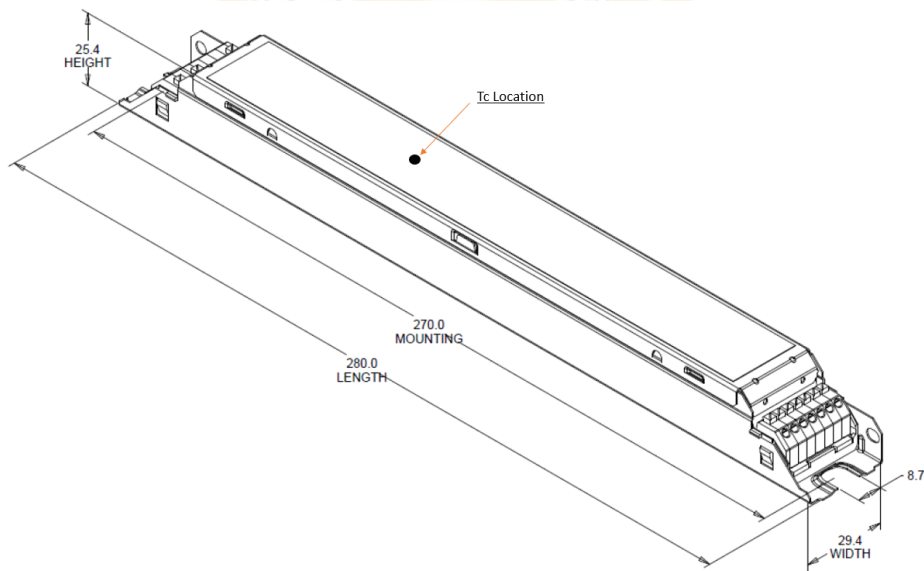

Mechanical Specification

Length	11.02" (280mm)
Width	1.15" (29.4mm)
Height	1.0" (25.4mm)
Mounting Length	10.63" (270mm)

Operating Range

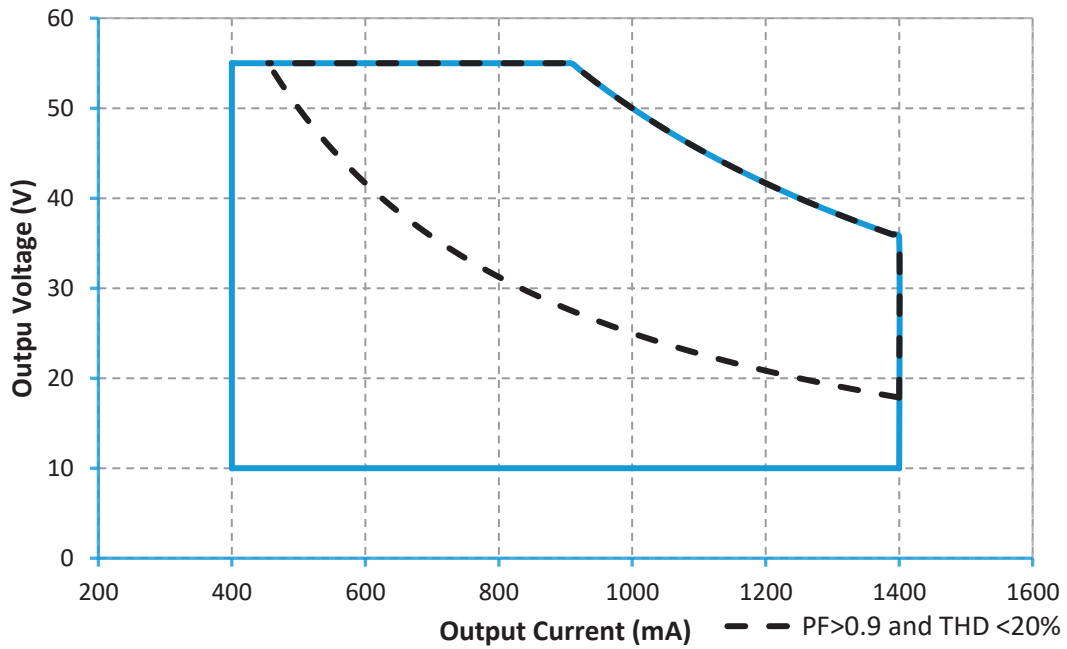

Note: Meeting DLC requirements requires minimum 50% loading.

Dimming Curve

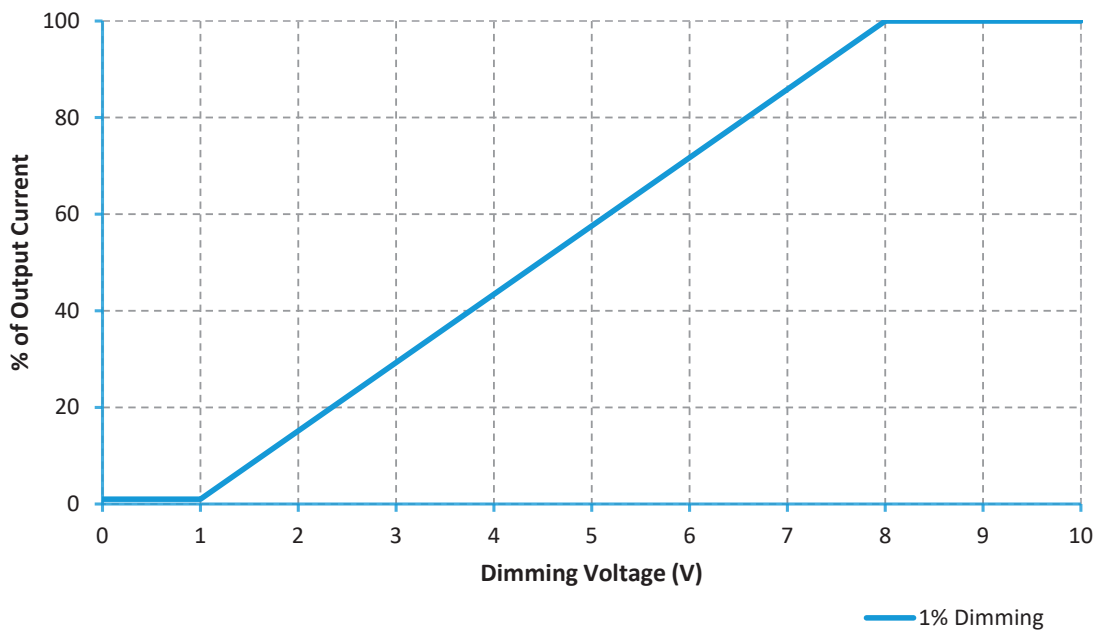

Note: Compliant with ANSI C137.1

Dim-To-Off Hysteresis

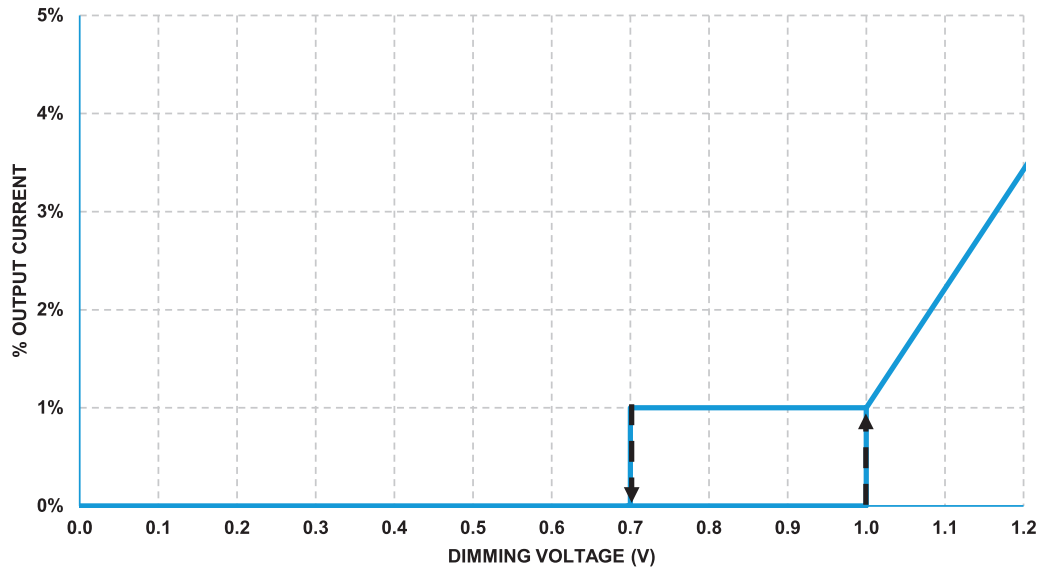

THD vs. Input Voltage (Full Load)

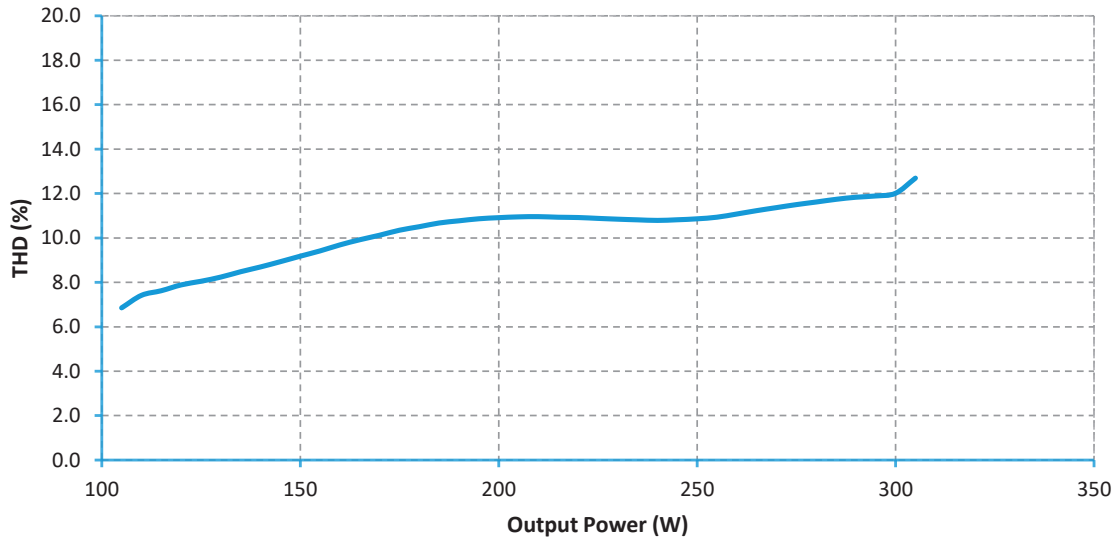

Power Factor vs. Input Voltage (Full Load)

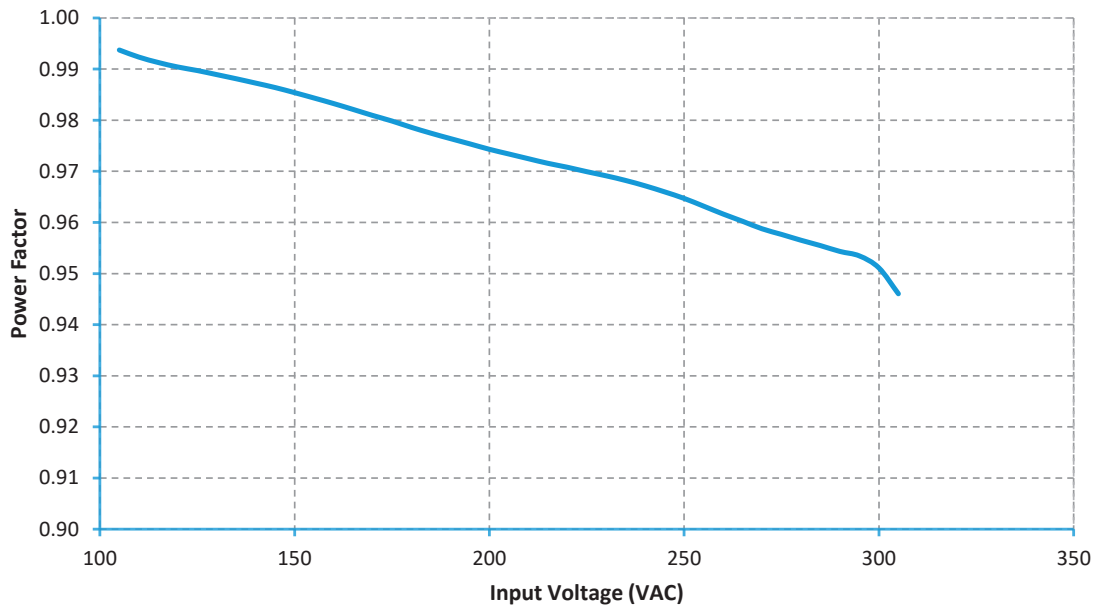

Efficiency vs. Output Voltage

Efficiency @ 120V

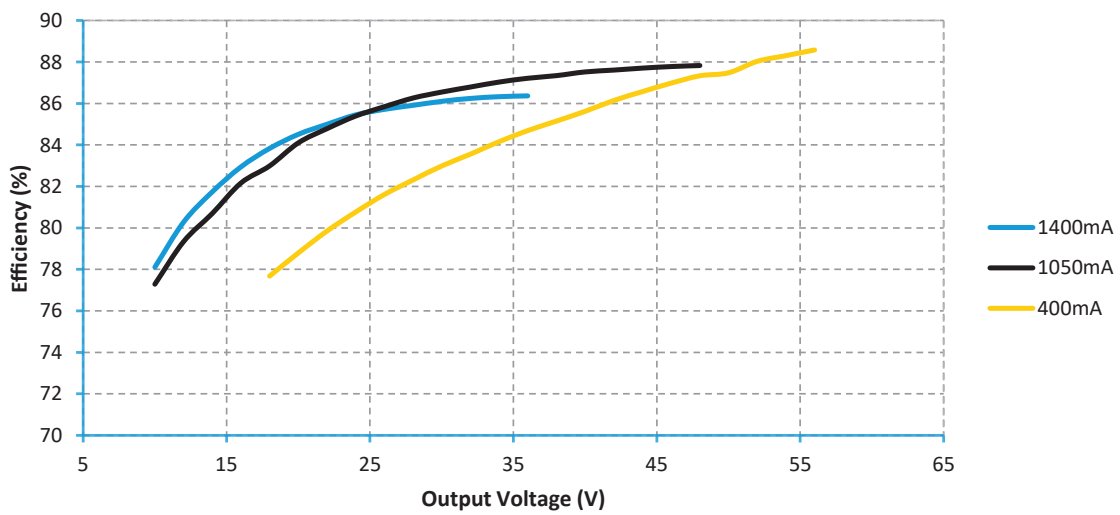

Efficiency @ 277V

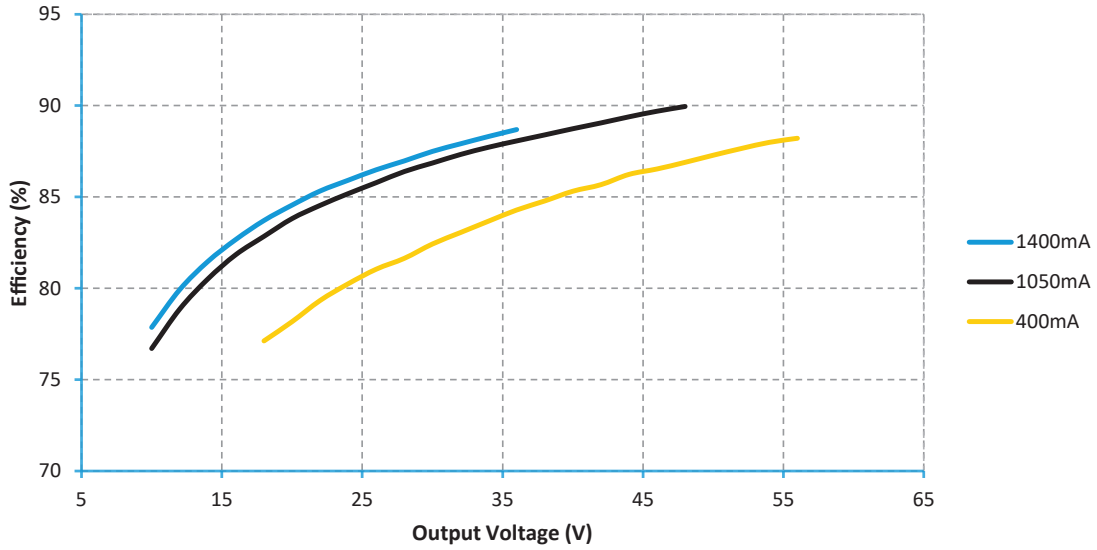

Power Factor vs Load

Power Factor vs Output Power

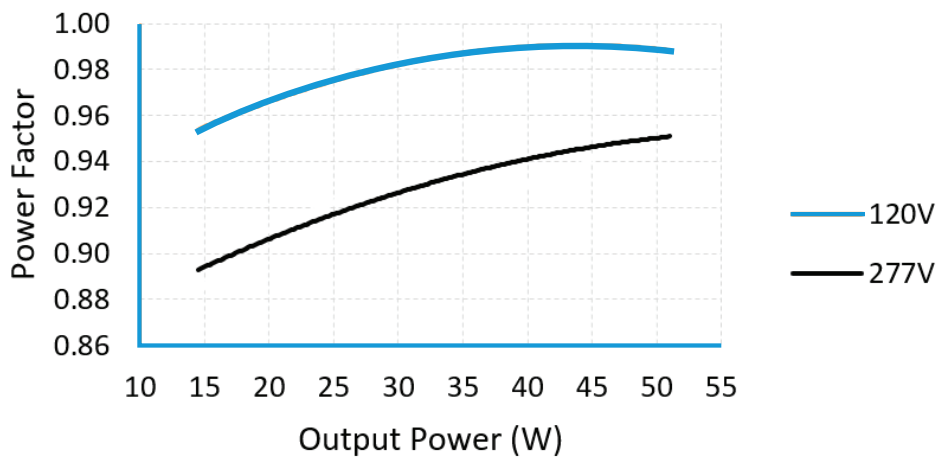

THD vs Load

THD vs Output Power

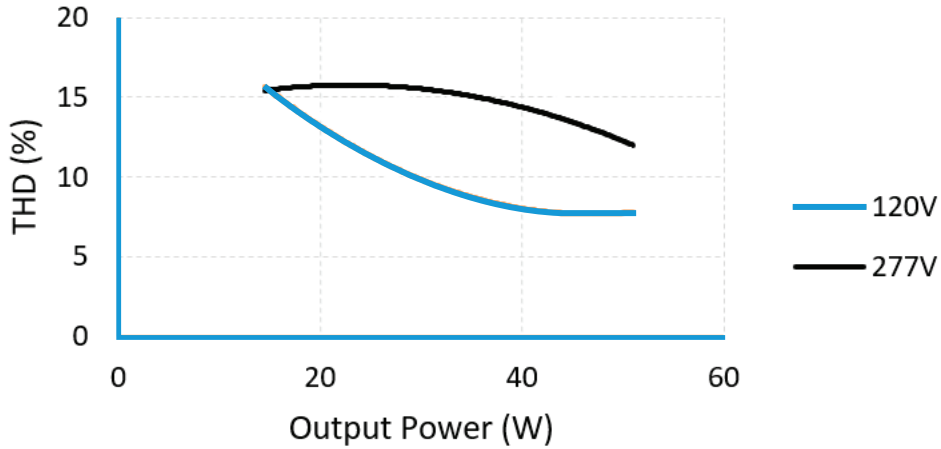

LED Thermal Protection (NTC) Characteristic

The LED thermal protection feature of the OTi 50W helps reduce the temperature of the LED module by reducing the output current in case of abnormal temperature conditions. To use this feature, a third party NTC thermistor should be connected to the LED power supply as shown in the wiring diagram below.

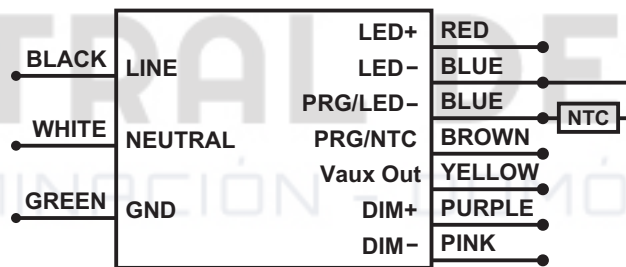

In the end application, care must be taken to place the NTC thermistor close to the hottest spot on the LED module. If LED thermal protection is not required the NTC port on the LED power supply connector can be left open. Vishay, EPCOS, Murata, Panasonic are some of the manufacturers of NTC thermistor. EPCOS part number for reference only - **B57164K153J (15kΩ @ 25°C)**. Murata part number for reference only - **NCP03XH223J05RL (22kΩ @ 25°C)**.

Note: Graphs for reference. The derating limits can be programmed using the OT Programmer.

Derating start = 6.3kΩ; Derating end = 4.3kΩ; Min output level = 10%

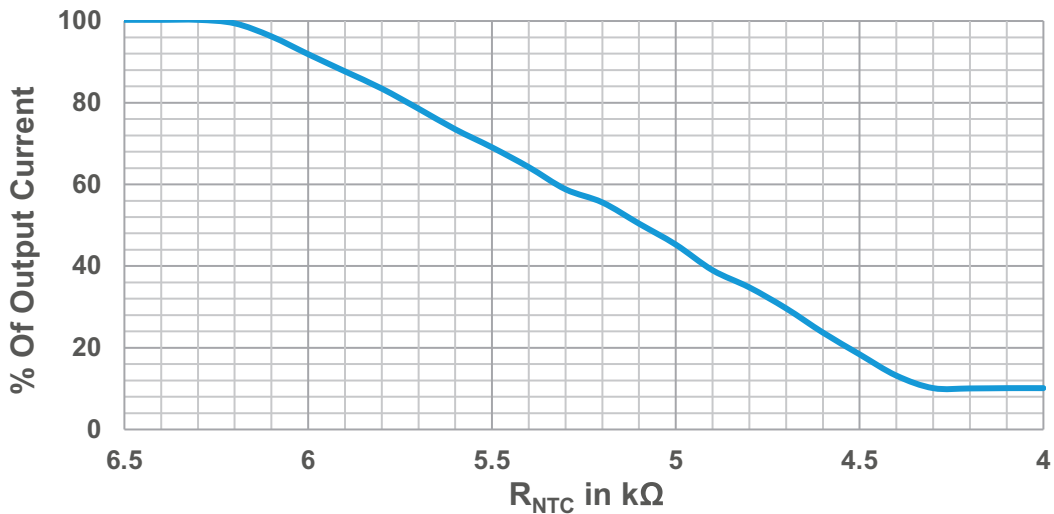

To learn more about this feature, please refer to the technical application guide for [LED Thermal Protection](#) (ECS304).

Architectural Dimming Features

Synchronize ON/OFF Timing and Dimming Controls

This feature meets efficacy requirements and ensures consistent dimming levels across multiple luminaires and individual luminaires that require multiple drivers.

True 1% Dimming

Architectural LED drivers support 1% dimming across the entire driver programmable output current range for True 1% dimming. For example, if a driver is programmed to 300mA, then at 1% dimming, output current would be 3mA.

DIM-to-OFF

DIM-to-OFF enables luminaires to smoothly transition from DIM-to-OFF and save energy without needing additional control equipment to turn off the fixture. Select architectural-grade LED drivers offer DIM-to-OFF and have a programmable AUX power output option to power and extend DIM-to-OFF capability to fixture-integrated sensors and controls.

Dimming Interface Protection

The dimming circuit in an OPTOTRONIC linear driver have protection against AC line voltage (120-277Vac) in the event that the driver is mis-wiring during field installation. When a mis-wired driver is powered up, the driver will provide a visual signal that indicates a potential wiring error.

Constant Lumen Maintenance

The Constant Lumen Maintenance feature of the OTi 50W helps to maintain the required lumen output of the fixture at a constant level throughout its lifetime. In general, LED's lumen output will depreciate over time and in order to maintain sufficient light level towards the end of lifetime, the LEDs are driven at high current initially and will result in more energy consumption. The constant lumen maintenance will give the flexibility to drive the LEDs at optimal driving current throughout its lifetime. This helps in energy savings, constant light output and enhanced reliability of the system.

Note: A detailed step-by-step instructions are outlined in the Help section of the OT Programmer software.

End-of-Life Indicator

The End-of-Life indicator helps the end user to receive a signal from the fixture indicating that it has reached its programmed life-time. After the LED driver reaches the programmed life-time, whenever it is turned ON, it stays at 'Dim' level (10%) for 10 minutes and reaches its appropriate level.

Inrush Characteristics

V _{in} (V)	I _{peak} (A)	T(@ 10% of I _{peak})
120	1.33	57 μs
277	2.66	46 μs

Complies with NEMA 410 inrush current requirements

Dimmer/Sensor Compatibility

Manufacturer	Part Number
Digital Lumens, Inc.	45678
Encelium LMS	EN-LCM-1R10V-GB2-BK EN-LCM-1R10V-GB2-BK/DR EN-ALC-1R10V-GB2-BK EN-ALC-1R10V-GB2-BK-DR
Leviton	IP710-DLX
Lutron	DVTV-XX
Wattstopper	ADF-120277
Synergy lighting Controls	ISD BC
Wattstopper	FD-301
Wattstopper	FSP-202
Enlighted Inc.	SU-3E-00 (Enlighted Compact Sensor)
Magnum Energy Solutions	Mx-OPUS-ML10V
Magnum Energy Solutions	Mx-USR-L1
Nedap	Luxon IoT Node ¹

Note: Please reference the dimmer manufacturer's instructions for installation. The absence of a dimmer from this chart does not necessarily imply incompatibility. Please contact your account representative for compatibility queries.

1 - Use the driver's 12Vaux setting.

Lifetime Curve

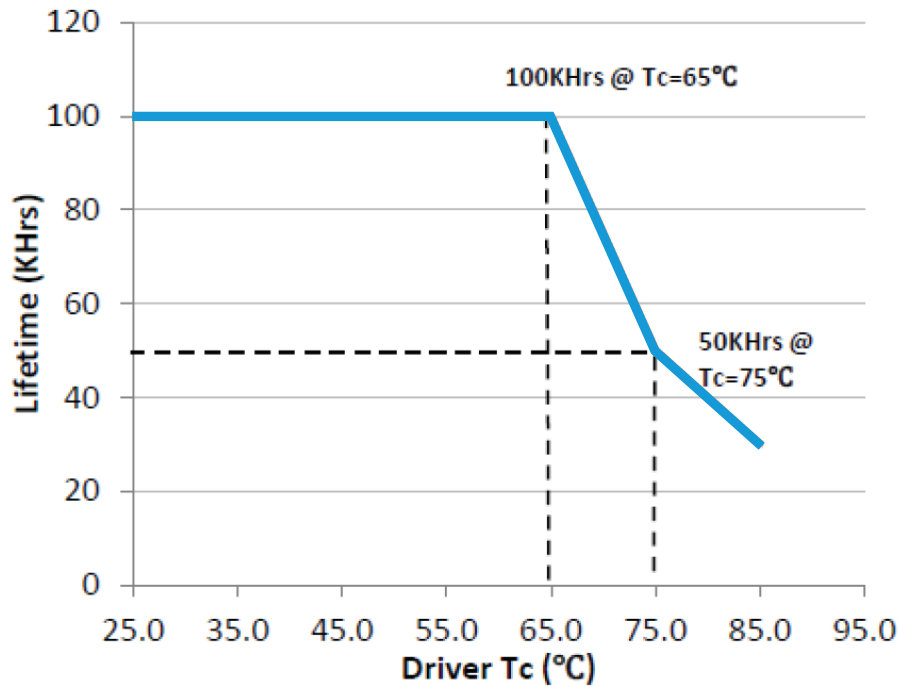

Warranty

eldoLED OPTOTRONIC® Products are covered by a 5-year limited warranty.
Complete warranty terms can be found at: www.eldoled.com/legal/terms-and-conditions

CENTRAL DE LUZ®

ILUMINACIÓN - DOMÓTICA

eldoLED

One Lithonia Way
Conyers, GA 30012
United States

+1 877 353 6533

nasupport@eldoLED.com
www.eldoLED.com

ECS-369 10-21

©2021 Acuity Brands Lighting, Inc.
Specifications subject to change without notice. Actual performance may differ as a result of end-user environment and application.