

Electrical Specifications

Input

Input Voltage (VAC)	120V-277V (+/- 10%)	
Frequency Range (Hz)	50 - 60 Hz (+/- 5%)	
	120V	277V
Input Current (A)	0.41	0.18
THD @ Full load	<20%	<20%
Power Factor @ Full load	>0.9	>0.9
Efficiency @ Full load	≥87%	≥87%
Inrush Current (Apk) ²	6.7	15.6
Line Regulation	< 5%	

2 - Complies to NEMA 410 inrush current requirements

Output

Output Current (mA)	400-1400mA (1mA step) 700mA default
Output Voltage (VDC)	8-55VDC
Output Ripple Current	<20% @ 1400mA
Max. Output Power (W)	40W ³
LED Power-Up Time	< 0.5sec CA T-24 Compliant
Load Regulation	<3%
Over Voltage Protection	Yes, non-latching
Over Load Protection	Yes, non-latching
Output Short-Circuit Protection	Yes, non-latching
Over Temperature Protection	Foldback to 50% at 100°C

3 - 39W LED + 1W Aux on AUX models

Dimming

Dimming Control	0 - 10V (Isolated)
Dimming Range ⁴	1-100%
Dimming Type	Current Reduction
Dimming Input Isolation	2.5kV
Source/Sink Current	0.2mA (max)
Dim-to-Off OFF/ON	0.7V/1V
Dim-to-Off Standby Power	< 1W
Dimming Interface Protection	Yes, 120-277Vac

CAUTION: Two power supplies if dimming is connected to non-class 2 circuits.

4 - Driver can be dimmed to TRUE 1% level (4mA) of the programmed output current of the driver. Programmable with 1mA resolution with +/- 3% accuracy.

Auxiliary Output (For AUX models only)

Output Voltage (VDC)	12/20/24V (configurable)
Output Power (W)	1W Max
Voltage Regulation	±10%

LED thermal protection (NTC)

NTC Value Active Range	≤25kΩ
Temperature Derating Start	User defined

External NTC cannot leave the fixture.
The PRG/ NTC control circuit terminals or lead wires are not isolated.
NTC must be connected if LED Thermal Protection feature is used.
The external NTC needs to be isolated or separated by live parts.

General Information

Item Number	*2743W1 (57351) (1%, F-type) *274A1L (57352) (1%, J-type) *2743W2 (57353) (1%, F-type, AUX) *274A1M (57354) (1%, J-type, AUX)
Type	Constant Current
Output Power	40W (Max.)
Programming Tool	*274A17 (51645)
Software	Download
Programmable Features	Output Current Soft start, Dim-to-Off Dimming Level LED thermal protection Constant lumen output End-of-life indicator Vaux (12/20/24V)

Find (NAED) as cross reference for new item number i.e. *12345

Environmental Specifications

Ambient Operating Temperature	-30°C to 50°C
Max. Case Temperature (Tc)	90°C Max 80°C (50kHrs) ¹
Max. Storage Temp.	75°C
Max. Relative Humidity (%)	85% non-condensing
Transient Protection	NEMA SSL 1 - 2010 Non-Roadway 2.5KV
UL Environmental Rating	Dry & Damp
UL File number	E320395
IP Rating	IP20
EMI Compliance	FCC Part 15 Class A
Sound Rating	Class A

1 - 5 year warranty applicable at 80°C

Architectural Dimming Features*

Synchronized On/Off & Dimming	Included
True 1% Dimming	Included
DIM to OFF	Included
Dimming Interface Protection	Included

*A complete description of OPTOTRONIC Driver Architectural Dimming Features can be found on page 8.



Wiring Diagram

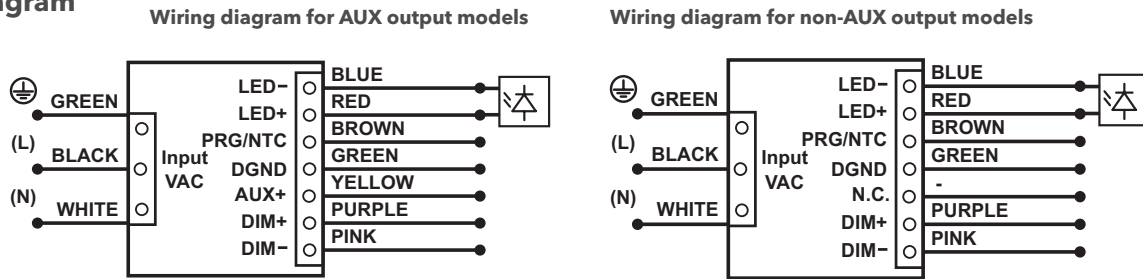

- Note:** - Maximum suggested remote mounting distance is 16 feet.
 - Wire extraction tool is needed to extract the wires from the connectors. (WAGO Part#- 210-719).
 - Use solid copper wire only: 16-20 AWG. Strip as below for all wires.
 - DGND can be used as AUX return path.
 - For wiring the output ports for the LED load, Vaux and DIM wire, 16 to 22 AWG is acceptable for use.
 For more detailed information and requirements, consult the light engine information and or information pertaining to the light engine connectors.



Key Application Notes

- Dim-to-off and Soft Start are programmable (enable/disable) features. The default mode for both features is disabled for out-of-the-box products. If these features are required, they must be enabled in the programming software.
- If LED Thermal Protection feature is used, a NTC thermistor must be connected to the driver.

Mechanical Specifications

Housing	F-Style	J-Style
Length	4.3" (109mm)	4.2" (106mm)
Width	2.4" (61.1mm)	2.4" (61.1mm)
Height	1.2" (27.5mm)	1.2" (27.5mm)
Mounting Length	4.5" (115mm)	2.0" (50.8mm)
Mounting Width	2.4" (61.1mm)	2.4" (61.1mm)

Mechanical Diagram - F-Style Housing

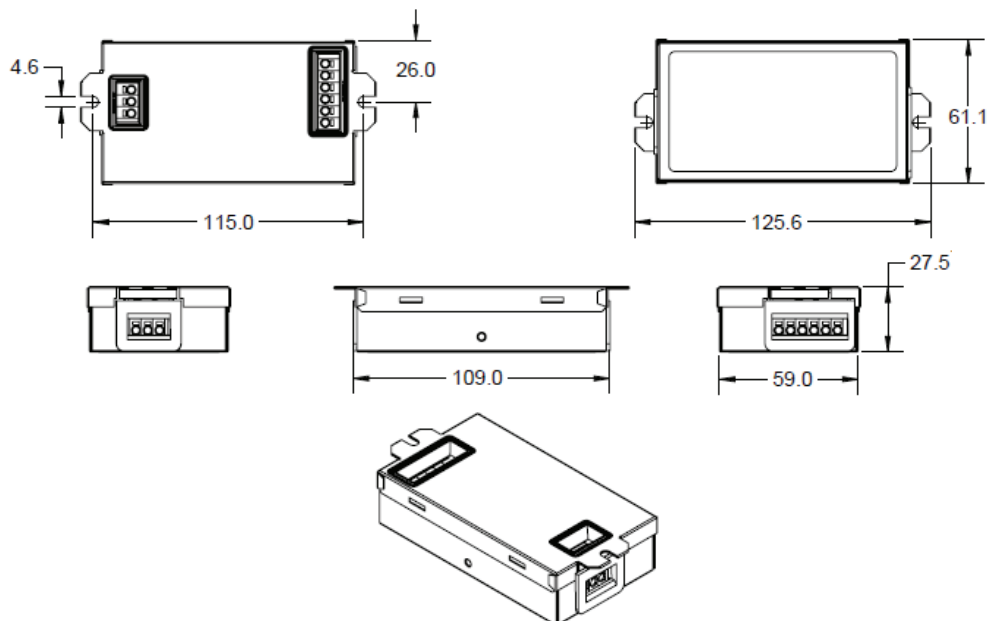

Mechanical Diagram - J-Style Housing

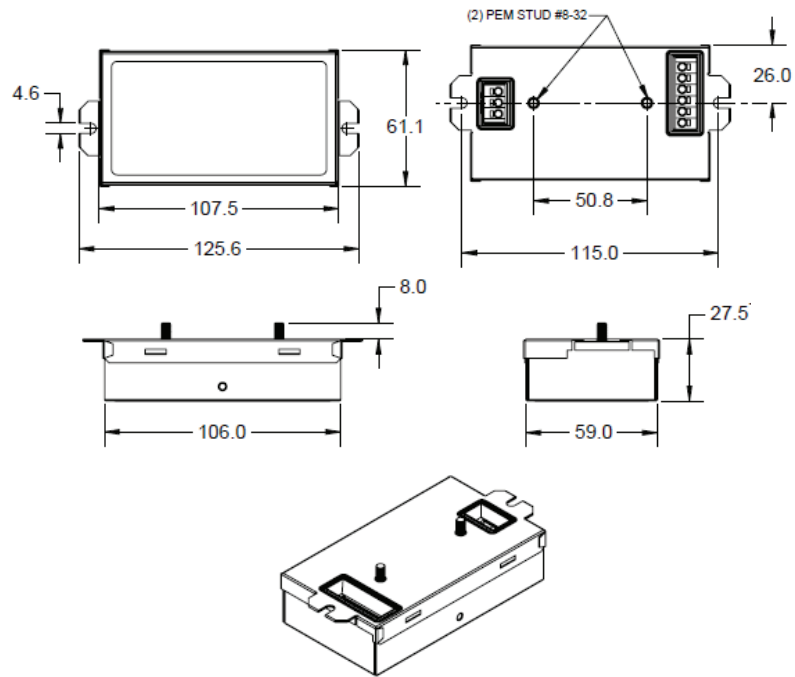

Operating Range

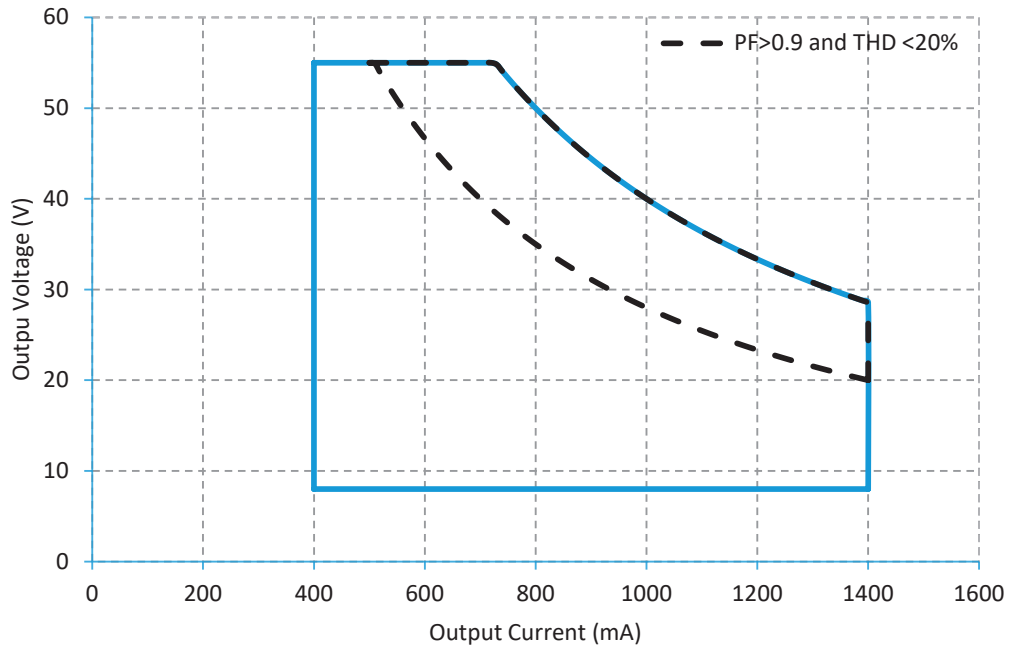

Dimming Curves

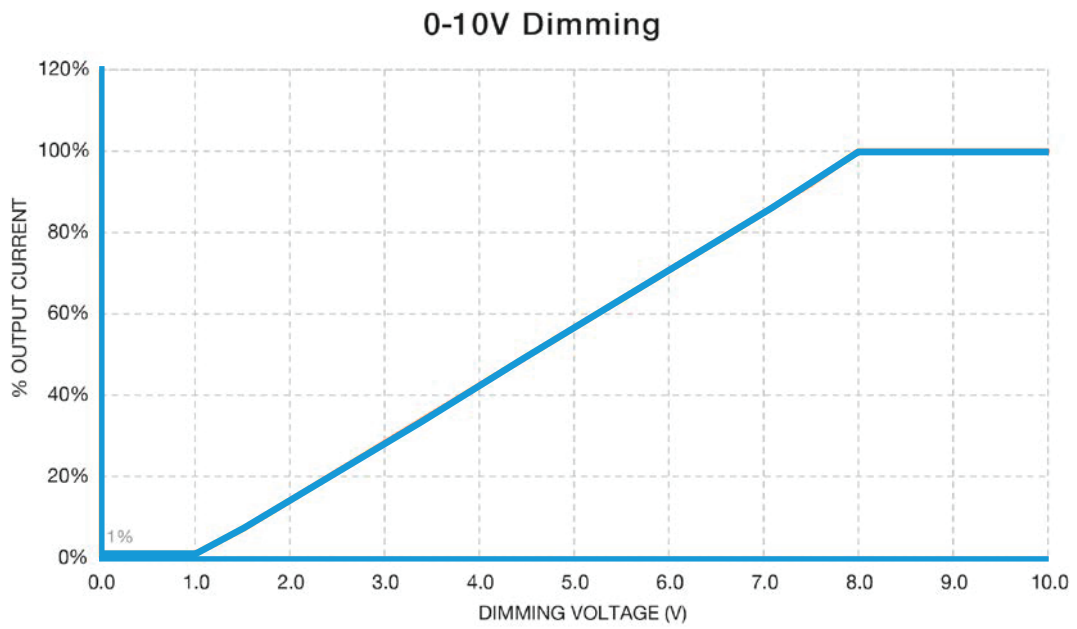

Note: Compliant with ANSI C137.1

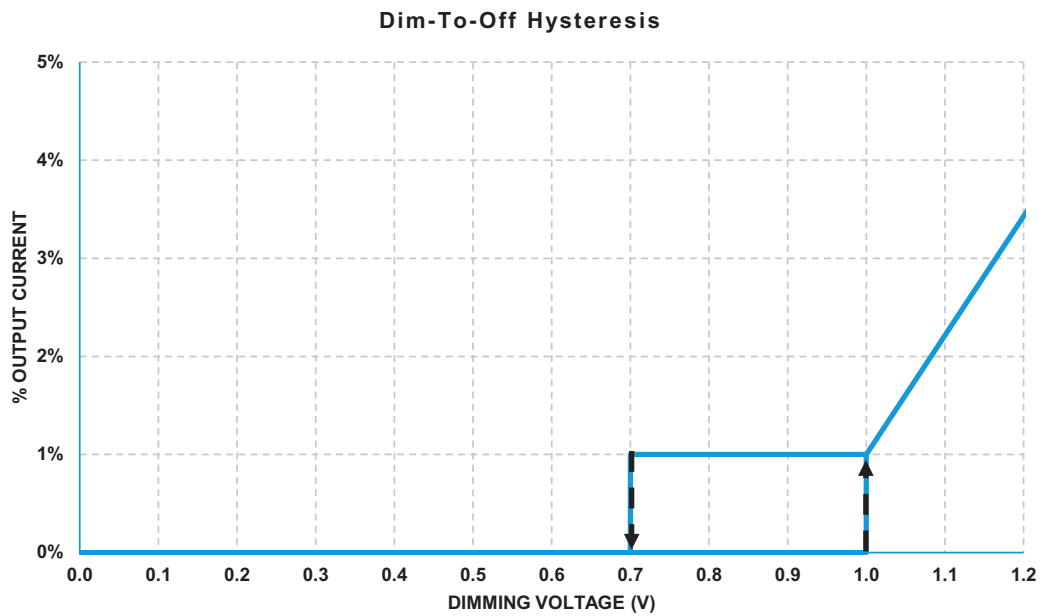

Efficiency vs Output Voltage

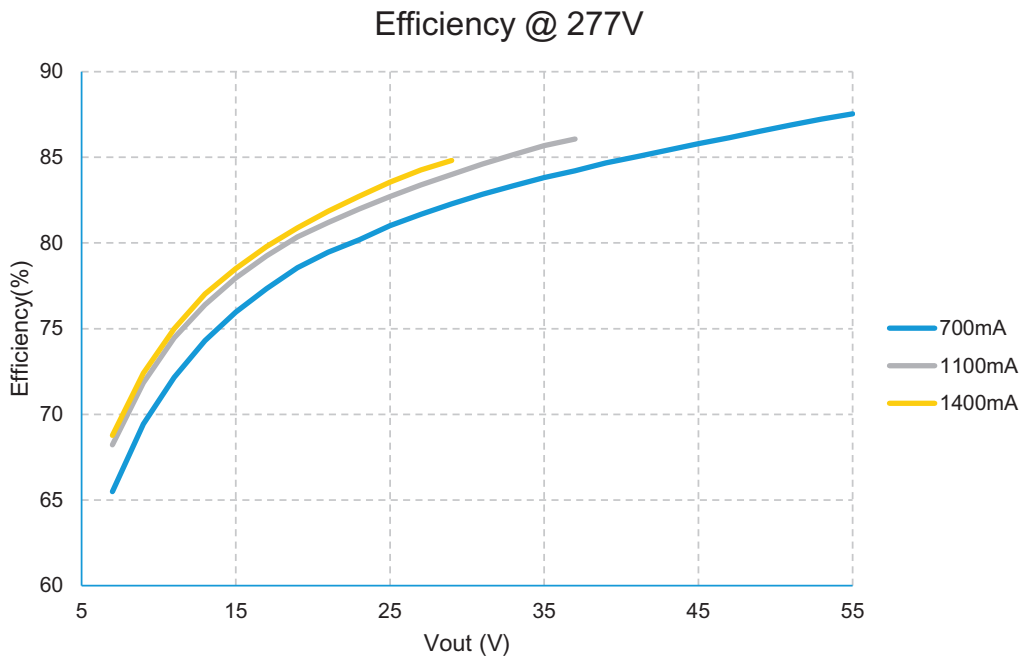
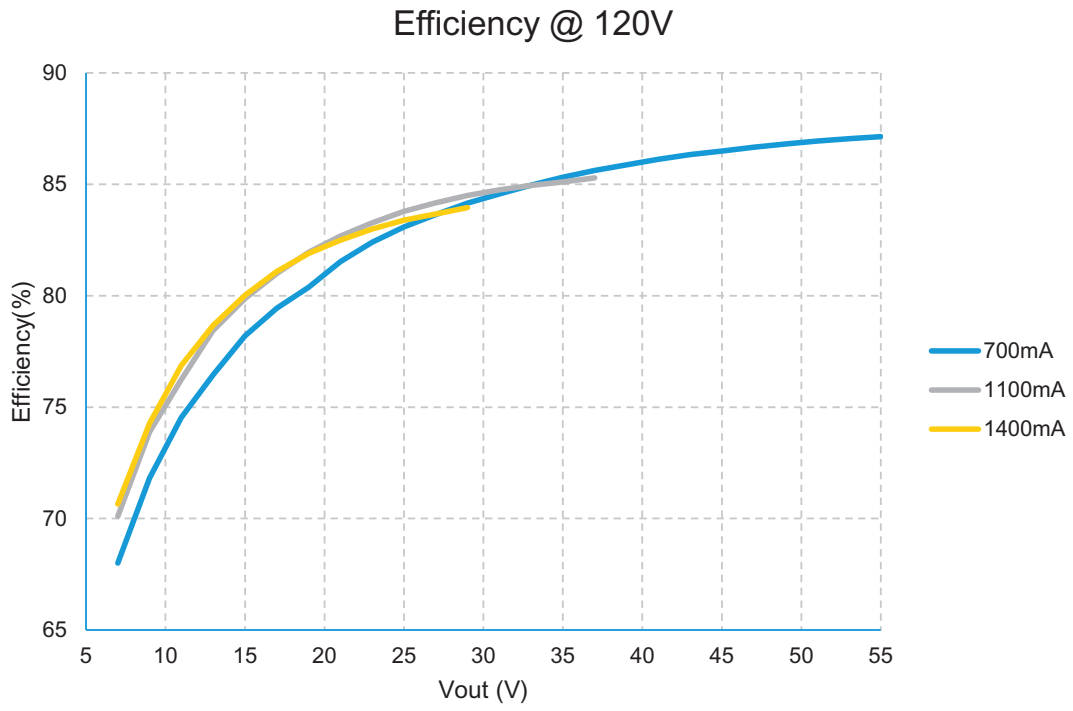

Power Factor vs Output Power

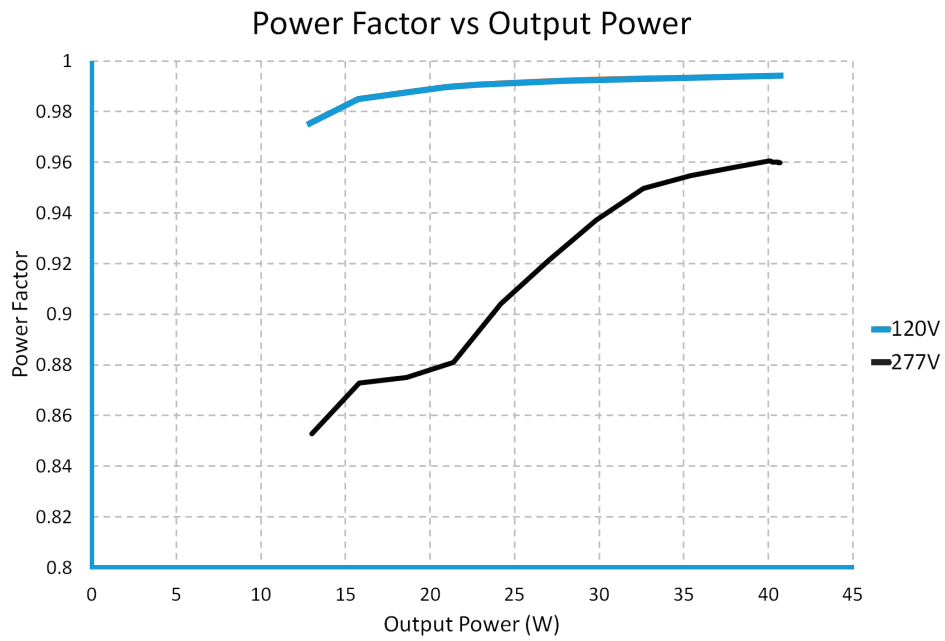

THD vs Output Power

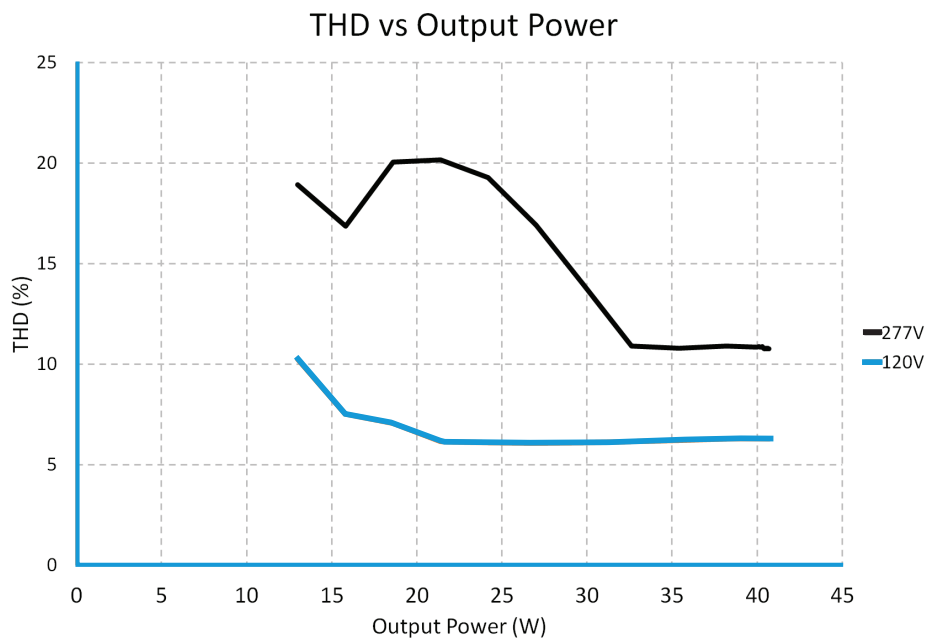

Inrush Characteristic

Vin (V)	Ipeak (A)	T(@ 10% of Ipeak)
120	6.7	150 μ s
277	15.6	90 μ s

Complies to NEMA 410 inrush current requirements

Dimmer/Sensor Compatibility

Manufacturer	Part Number
Digital Lumens, Inc.	45678
Encelium LMS	EN-ILCM-1R10V-GB2-BK EN-ILCM-1R10V-GB2-BK/DR EN-ALC-1R10V-GB2-BK EN-ALC-1R10V-GB2-BK/DR
Leviton	IP710-DLZ
Lutron	DVTV-XX
Wattstopper	ADF-120277
Synergy Lighting Controls	ISD BC

Note: The absence of a dimmer from this chart does not necessarily imply incompatibility. Please reference the dimmer manufacturer's instructions for installation.

Architectural Dimming Features

Synchronize ON/OFF Timing and Dimming Controls

This feature meets efficacy requirements and ensures consistent dimming levels across multiple luminaires and individual luminaires that require multiple drivers.

True 1% Dimming

Architectural LED drivers support 1% dimming across the entire driver programmable output current range for True 1% dimming. For example, if a driver is programmed to 300mA, then at 1% dimming, output current would be 3mA.

DIM-to-OFF

DIM-to-OFF enables luminaires to smoothly transition from DIM-to-OFF and save energy without needing additional control equipment to turn off the fixture. Select architectural-grade LED drivers offer DIM-to-OFF and have a programmable AUX power output option to power and extend DIM-to-OFF capability to fixture-integrated sensors and controls.

Dimming Interface Protection

The dimming circuit in an OPTOTRONIC linear driver have protection against AC line voltage (120-277Vac) in the event that the driver is mis-wiring during field installation. When a mis-wired driver is powered up, the driver will provide a visual signal that indicates a potential wiring error.

End-of-Life Indicator

The End-of-Life indicator helps the end user to receive a signal from the fixture indicating that it has reached its programmed life-time. After the LED driver reaches the programmed life-time, whenever it is turned ON, it stays at Dim level (10%) for 10 minutes and reaches its appropriate level.

Constant Lumen Maintenance

The Constant Lumen Maintenance feature of the OTi40W helps to maintain the required lumen output of the fixture at a constant level throughout its lifetime. In general LED's lumen output will depreciate over time and in order to maintain sufficient light level towards the end of lifetime, the LED's are driven at high current initially and will result in more energy consumption. The constant lumen maintenance will give the flexibility to drive the LEDs at optimal driving current throughout its lifetime. This helps in energy savings, constant light output and enhanced reliability of the system.

Note: Step-by-step instructions are outlined in the OT Programmer User Manual embedded in the software.

LED Thermal Protection (NTC) Characteristic

The LED thermal protection feature of the OTi40W helps reduce the temperature of the LED module by reducing the output current in case of abnormal temperature conditions. To use this feature a third party NTC thermistor should be connected to the LED power supply as shown in the wiring diagram below.

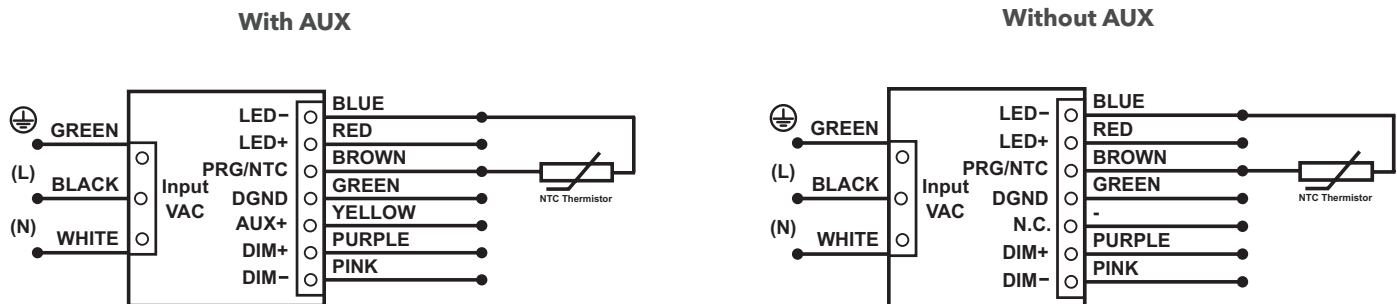

In the end application, care must be taken to place the NTC thermistor close to the hottest spot on the LED module. If LED thermal protection is not required the NTC port on the LED power supply connector can be left open. Vishay, EPCOS, Murata, Panasonic are some of the manufacturers of NTC thermistor. EPCOS part number for reference only **B57164K153J (15kΩ @ 25°C)**.

Murata part number for reference only - **NCP03XH223J05RL (22kΩ @ 25°C)**. Please refer to LED Thermal Protection App Note at: <https://www.datocms-assets.com/47741/1639084995-ntc-thermal-protection-technical-guide.pdf>

Note: Graphs for reference. The derating limits can be programmed using the OT Programmer (*274A17).

Derating start = 6.3k Ω ; Derating end = 4.3k Ω ; Min output level = 10%

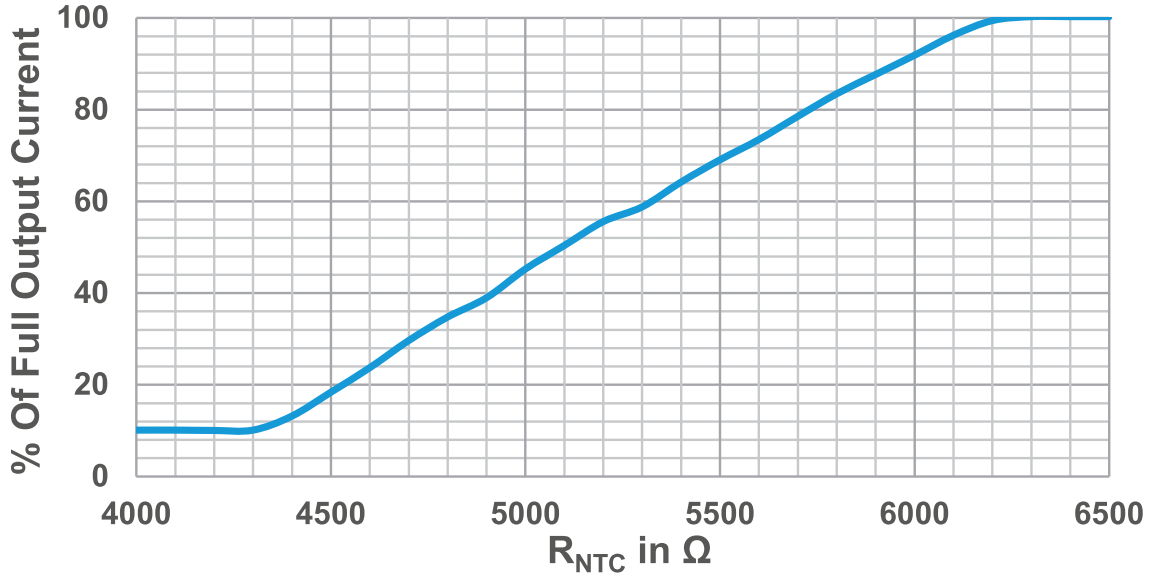

Derating start = 18k Ω ; Derating end = 2k Ω ; Min output level = 5%

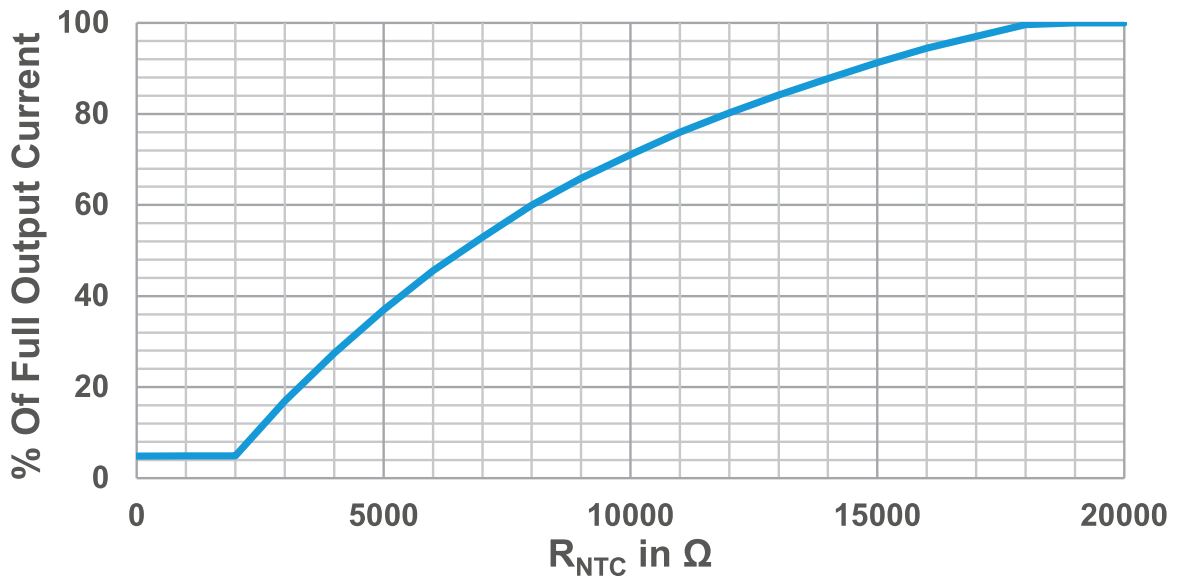

Lifetime vs Tc

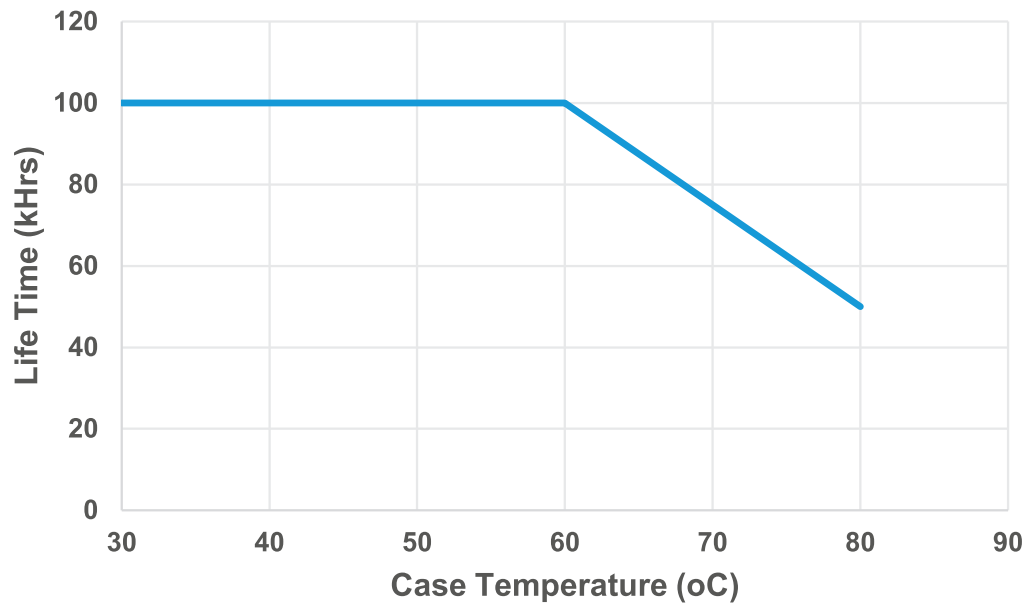

Warranty

eldoLED OPTOTRONIC® Products are covered by a 5-year limited warranty.
Complete warranty terms can be found at: www.eldoled.com/legal/terms-and-conditions

eldoLED

One Lithonia Way
Conyers, GA 30012
United States

+1 877 353 6533

nasupport@eldoLED.com
www.eldoLED.com

ECS332R2 09-22

©2022 Acuity Brands Lighting, Inc.
Specifications subject to change without notice. Actual performance may differ as a result of end-user environment and application.