

## PTi 2X70/220...240 I

POWERTRONIC INTELLIGENT PTi I | ECG for HID lamps, with cable clamp



### Areas of application

- Shop lighting
- Health and fitness areas (in luminaires with protection class IP66 or higher)
- Effect and accent lighting

### Product family benefits

- Extended terminal section enables mains looping
- Screw-down cable clamps for reliable strain relief
- Long reliable life at maximum permitted temperatures
- Automatic safety shutdown of lamps in the event of a defect or at end of life (EoL)

### Product family features

- Energy Efficiency Index EEI: A2
- Supply voltage: 220...240 V
- Line frequency: 50...60 Hz
- RI suppression: to EN 55015/CISPR 15
- Safety: to EN 61347-2-12
- Line harmonics according to EN 61000-3-2
- Immunity according to EN 61547

# Product datasheet

## Technical data

### Electrical data

Lamp wattage	2*73 W
Line current	0.70 A <sup>1)</sup>
Ignition voltage	4.5 kVp
Operating frequency	0.165 kHz
System wattage	159.00 W
ECG efficiency	92 %
Input voltage AC	198...254 V
Nominal voltage	220...240 V
Mains frequency	50...60 Hz
Power factor $\lambda$	0.95 <sup>2)</sup>
Inrush current	70 A <sup>3)</sup>
Max. ECG no. on circuit breaker 10 A (B)	4 <sup>4)</sup>
Max. ECG no. on circuit breaker 16 A (B)	7 <sup>4)</sup>
Max. no. of ECGs on 16A MCB with EBN-OS	17 <sup>4)</sup>
Protective conductor current	0.5 mA
U-OUT (working voltage)	250 V
Max. working voltage between LH and LL	250 V
Max. working voltage betw. LL/LH & earth	250 V
Max. capacitance of wire ECG/lamp	120 pF

1) At 230 V<sub>AC</sub>

2) Minimum

3)  $t_{width} = 250 \mu s$  (measured at 50 % I<sub>peak</sub>)

4) Type B

### Dimensions & weight

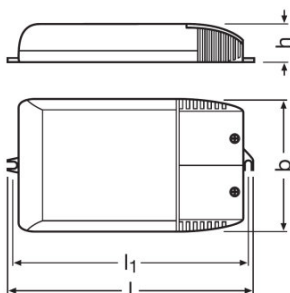

Length	223.0 mm
Width	98.0 mm

## Product datasheet

Height	32.0 mm
Mounting hole spacing, length	215.0 mm
Cable cross-section, input side	0.75...2.5 mm <sup>2</sup>
Cable cross-section, output side	0.75...2.5 mm <sup>2</sup>
Wire preparation length, input side	10...11 mm
Wire preparation length, output side	10...11 mm
Product weight	450.00 g

### Colors & materials

Casing material	Plastic
-----------------	---------

### Temperatures & operating conditions

Ambient temperature range	-25...+50 °C
Maximum temperature at tc test point	75 °C

### Lifespan

ECG lifetime	40000 h <sup>1)</sup>
--------------	-----------------------

<sup>1)</sup> At maximum T<sub>c</sub> / 10% failure rate

### Additional product data

Design / version	With cable clamp
Suitable for lamp power (2 lamps)	73 W
Available until	2014-12-31 <sup>1)</sup>

<sup>1)</sup> Last order until December 1st, 2014

### Capabilities

Max. cable length to lamp/LED module	1.5 m
Overheating protection	Power reduction and switch off at T > 75 °C at the tc point
ECG reset time	> 0.5 s
Cable/wire types, input side	NYM-J 3x1.5 / NYM-J 3x2.5 / H05VV-F 3x1.5 / NHXMH-J 3x1.5 mm <sup>2</sup>
Cable/wire types, output side	SIHF-J 3x1.5 / SIHF-J 3x2.5 / SIHSI 3x1.0 mm <sup>2</sup>
Dimmable	No
Restriction on ignition time	20 min
Suitable for fixtures with prot. class	I

### Certificates & standards

Approval marks – approval	ENEC 10 / VDE / VDE-EMC / GOST / C-Tick
Type of protection	IP20

## Product datasheet

EEI – Energy Label	A2
Standards	Acc. to EN 61347-2-12/Acc. to EN 55015/Acc. to EN 61000-3-2/Acc. to EN 61547/Acc. to EN 62493

### Logistical data

Commodity code	850410809000
----------------	--------------

### Wiring Diagram

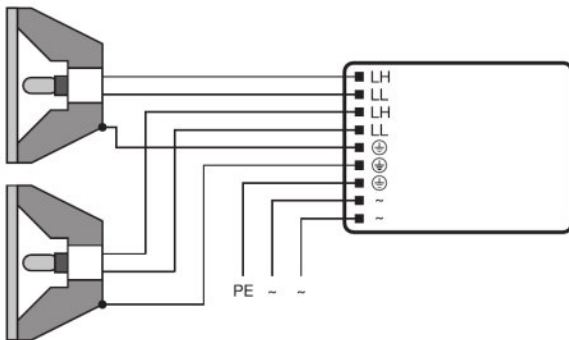

### Wiring diagram

### Safety advice

Ballast losses and lamp heat radiation can lead to heat accumulation in a completely closed case. Therefore it is necessary to ensure that the temperature at the measuring point t of the ECG does not exceed the maximum value.

### Attention!







For safety reasons disconnect the device before replacing the lamp!

### Download Data

File	
	Product Datasheet 57985_ADDON TECHNICAL INFORMATION PTi 2x70 I (GB)

## Product datasheet

---

	Tender documents 339884_Tender Document for POWERTRONIC EVG.eng
	Certificates 346461_PTi - PTo - PTg VDE-ENEC-Cert
	Declarations of conformity Declaration of conformity PTi 2x35, PTi 2x70
	Installation/Operation notice 334206_Technical guide - POWERTRONIC for HID-lamps (GB)
	CAD data PTi 2x35 I, PTi 2x70 I
	CAD data PTi 2x35 I, PTi 2x70 I
	CAD data PDF PTi 2x35 I, PTi 2x70 I

---

### Logistical Data

Product code	Product description	Packaging unit (Pieces/Unit)	Dimensions (length x width x height)	Volume	Gross weight
4008321910042	PTi 2X70/220...240 I	Shipping carton box 20	496 mm x 100 mm x 479 mm	23.76 dm <sup>3</sup>	10405.00 g

---

The mentioned product code describes the smallest quantity unit which can be ordered. One shipping unit can contain one or more single products. When placing an order, for the quantity please enter single or multiples of a shipping unit.

### Disclaimer

Subject to change without notice. Errors and omission excepted. Always make sure to use the most recent release.

## PTi 2X70/220...240 I

POWERTRONIC INTELLIGENT PTi I | ECG for HID lamps, with cable clamp

Product name	Lamp group
PTi 2X70/220...240 I	HCI-E/P 70W
	HCI-ET 70W
	HCI-PAR30 70W
	HCI-T 70W
	HCI-TC 70W
	HCI-TS 70W
	HQI-E 70W
	HQI-T 70W
	HQI-TS 70W

---