

EM powerLED NM BASIC 1 W

Emergency lighting LED driver 1 W



Screw-fix



Clip-fix

Product description

- _ Emergency lighting LED driver for manual testing
- _ For self-contained emergency lighting
- _ Non maintained operation
- _ SELV for output voltage < 60 V DC
- _ Low profile casing (21 x 30 mm cross-section)
- _ EM = Emergency
- _ 5 years guarantee (conditions at www.tridonic.com)

Properties

- _ Constant current mode
- _ With either screw or clip fastening (clip-fix)
- _ 3 h rated duration
- _ Green charge status display LED
- _ Electronic charge system
- _ SELV classified (outputs powerLED, battery, status LED, test switch)
- _ Polarity reversal protection for battery
- _ Deep discharge protection
- _ Very low energy consumption from the battery after activation of the deep discharge protection
- _ Short-circuit-proof battery connection
- _ Emergency lighting LEDs available
- _ Optional test switch

Batteries

- _ High-temperature cells
- _ NiMH batteries
- _ Cs cells
- _ 4 year design life
- _ 1 year guarantee (conditions at www.tridonic.com)
- _ For battery compatibility refer to data sheet

Website

<http://www.tridonic.com/89800111>



EM powerLED NM BASIC 1 W

Emergency lighting LED driver 1 W

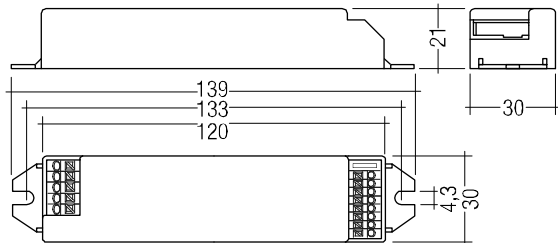

Screw-fix

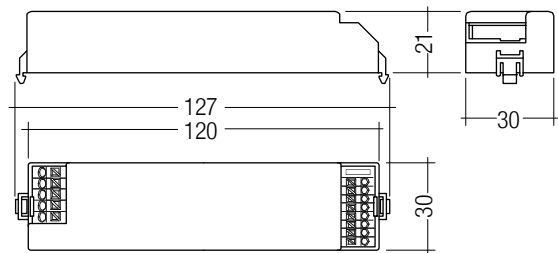

Clip-fix

Ordering data

Type	Article number	Dimensions L x W x H	Max. number of LEDs	Wattage	Packaging, carton	Packaging, pallet	Weight per pc.
Clip fastening version							
EM powerLED NM 1W BASIC	89800111	127 x 30 x 21 mm	1	1 W	25 pc(s).	1,200 pc(s).	0.05 kg
Screw fastening version							
EM powerLED NM 1W BASIC	89800112	139 x 30 x 21 mm	1	1 W	25 pc(s).	1,200 pc(s).	0.05 kg

Technical data

Rated supply voltage	220 – 240 V
Mains frequency	50 / 60 Hz
Forward voltage range LED module	2.8 – 3.4 V
Mains current	15 mA
Mains power in charging operation	1.3 W
LED current in emergency operation	320 mA
Starting time	0.43 s from detection of emergency event
Overvoltage protection	320 V (for 1 h)
Battery charging time	24 h
Charge current	120 mA
Battery discharge current	Refer to data sheet
Number of cells	3
Max. casing temperature t_c	70 °C
Ambient temperature t_a	0 ... +60 °C
Mains voltage changeover threshold	According to EN 60598-2-22
Type of protection	IP20
Lifetime	up to 50,000 h
Guarantee (conditions at www.tridonic.com)	5 Year(s)

Approval marks**Standards**

according to EN 50172, according to EN 60598-2-22, EN 61347-2-7, EN 61347-2-13, EN 62384, EN 61547, EN 55015, EN 61000-3-2, EN 60068-2-29, EN 60068-2-30, EN 60068-2-64

Test switch EM2

Accessory



Product description

- _ For connection to the emergency lighting unit
- _ For checking the device function
- _ Dielectric strength: 1,500 V AC for 60 seconds

Website

<http://www.tridonic.com/89805277>



Ordering data

Type	Article number	Packaging, bag	Packaging, carton	Weight per pc.
Test switch EM 2	89805277	25 pc(s).	600 pc(s).	0.009 kg

Approval marks

RoHS

Status indication green LED EM

Accessory



Product description

- _ A green LED indicates that charging current is flowing into the battery

Website

<http://www.tridonic.com/89899605>



Ordering data

Type	Article number	Packaging, bag	Packaging, carton	Weight per pc.
LED EM green	89899605	25 pc(s).	200 pc(s).	0.011 kg
LED EM green, ultra high brightness	89899756	25 pc(s).	200 pc(s).	0.012 kg

Approval marks

RoHS

1. Standards

- EN 61347-2-7
- EN 61347-2-13
- EN 62384
- EN 61547
- EN 55015
- EN 61000-3-2
- EN 60068-2-29
- EN 60068-2-30
- EN 60068-2-64
- according to EN 50172
- according to EN 60598-2-22

1.1 Glow-wire test

according to EN 60598-1 with increased temperature of 850 °C passed.

1.2 Insulation and electric strength testing of luminaires

Electronic LED driver can be damaged by high voltage. This has to be considered during the routine testing of the luminaires in production.

According to IEC 60598-1 Annex Q (informative only!) or ENEC 303-Annex A, each luminaire should be submitted to an insulation test with 500 V_{dc} for 1 second. This test voltage should be connected between the interconnected phase and neutral terminals and the earth terminal. The insulation resistance must be at least 2 MΩ.

As an alternative, IEC 60598-1 Annex Q describes a test of the electrical strength with 1,500 V_{AC} (or 1,414 x 1,500 V_{DC}). To avoid damage to the electronic devices this test **must not be conducted**.

2. Thermal data

2.1 Expected lifetime

Average lifetime 50,000 hours under rated conditions with a failure rate of less than 10 %. Average failure rate of 0.2 % per 1000 operating hours.

3. Installation / Wiring

3.1 Wiring diagrams

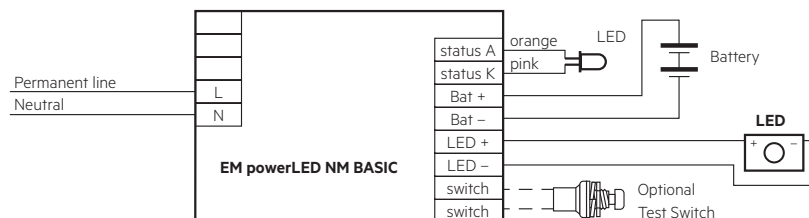

Take care that the LED is connected with the right polarity. LED that are connected to the EM powerLED devices should have a reverse polarity protection device such as a schottky diodes fitted, otherwise irreversible damage could occur if the LED is connected in reverse polarity. Any protection device must be capable of handling in excess of 700 mA.

Note: The Tridonic Emergency-LED is therefore fitted with a protection diode across the powerLED.

Note for manually tested emergency lighting with combined LED modules:

Due to the fact that independent circuits are used for normal and emergency lighting it is important that the normal supply of the mains LED driver is switched off together with the permanent emergency supply prior to checking the operation of the emergency LEDs.

If this is not done then it may not be possible to see that the emergency LEDs are operating. Use a circuit similar to that shown next.

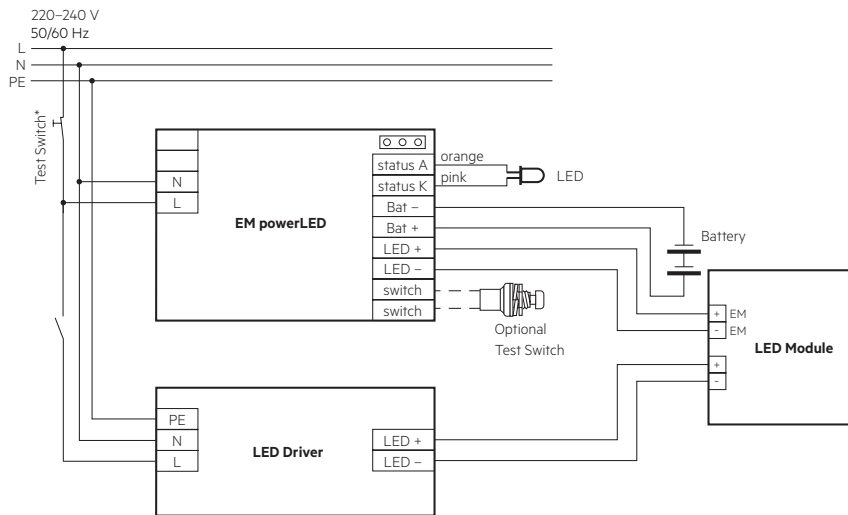

* Use 230 V Test switch

3.2 Wiring type and cross section

The wiring can be in stranded wire or solid. Strip 8.5–9.5 mm of insulation from the cables to ensure perfect operation of the push-wire terminals.

Wiring
mains (N, L)

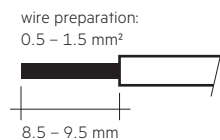

Wiring
batteries (Bat +, Bat -)
test switch (switch)
status indication LED (status K, A)
LED (LED+, LED-)

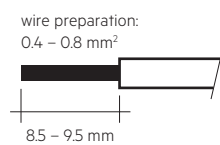

Max. lead insulation diameter

Battery	2.1 mm
Test switch	2.1 mm
Indicator LED	2.1 mm
LED	2.1 mm

Maximum lead length

LED	3 m
status indication LED	1 m
batteries	1 m

3.4 Wiring instructions

- The EM powerLED terminals, battery, indicator LED and test switch terminals are classified as SELV. Keep the wiring of the input terminals separated from the wiring of the SELV terminals or consider special wiring (double insulation, 6 mm creepage and clearance) when these connections should be kept SELV.
- EM powerLED leads should be separated from the mains connections and wiring for good EMC performance.
- Maximum lead length on the EM powerLED terminals is 3 m. For a good EMC performance keep the LED wiring as short as possible.
- The secondary wires (LED module) should be routed in parallel to ensure good EMC performance.
- Maximum lead length for the test switch and Indicator LED connection is 1 m. The test switch and Indicator LED wiring should be separated from the EM powerLED leads to prevent noise coupling.
- Battery leads are specified with 0.5 mm² cross section and a length of < 1 m.
- To avoid the damage of the control gear, the wiring must be protected against short circuits to earth (sharp edged metal parts, metal cable clips, louver, etc.).

3.3 Release of the wiring

Press down the “push button” and remove the cable from front.

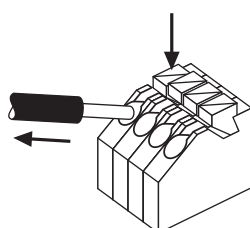

4. Mechanical data

4.1 Housing properties

- Polycarbonat white
- Type of protection IP 20

4.2 Recommended fixing details for clip fixing

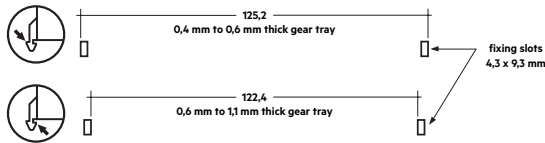

4.2 Mechanical data accessories

LED status indicator

- Green
- Mounting hole 6.5 mm diameter, 1 – 1.6 mm thickness
- Lead length 1000 mm

Test switch

- Mounting hole 7.0 mm diameter
- Lead length 550 mm

Battery leads

- Quantity: 1 red and 1 black
- Length: 1 m
- Wire type: 0.5 mm² solid conductor
- Insulation rating: 90 °C

Battery end termination

Push on 4.8 mm receptacle to suit battery spade fitted with insulating cover

Module end termination

8.0 mm stripped insulation

Two-piece batteries are supplied with a 200 mm lead with 4.8 mm receptacles at each end and insulating covers to connect the separate sticks together.

5. Electrical data

5.1 Maximum loading of automatic circuit breakers

Automatic circuit breaker type	B10	C10	B13	C13	B16	C16	B20	C20	Inrush current
Installation Ø	1.5 mm ²	1.5 mm ²	1.5 mm ²	1.5 mm ²	2.5 mm ²	2.5 mm ²	2.5 mm ²	2.5 mm ²	I _{max} time
EM powerLED NM 1W BASIC	90	180	130	260	130	260	130	260	10 A 120 µs

5.2 Insulation matrix

	Mains	Battery, LED, Test switch, Indicator LED
Mains	–	••
Battery, LED, Test switch, Indicator LED	••	–

• Represents basic insulation

•• Represents double or reinforced insulation

6. Battery data

6.1 Battery selection

EM powerLED NM 1W BASIC, 3 h

		Type	EM powerLED NM 1W BASIC		
		Article no.	89800111, 89800112		
		Duration	3 h		
		Cells	3 cells		
Technology and capacity	Design	Number of cells	Type	Article no.	Assignable batteries
NiMh 2.2Ah Cs cells	stick	1 x 3	Accu-NiMh 3A	28002088	•
	remote box	1 x 3	Pack-NiMH 2.2Ah 3 CON	28001898	•

6.2 Battery charge / discharge

EM powerLED NM 1W BASIC, 3 h

Type	EM powerLED NM 1W BASIC	
Article no.	89800111, 89800112	
Duration	3 h	
Cells	3 cells	
Battery charge time	24 h	
Charge current	120 mA	
Discharge current	350 mA at typ. LED forward voltage	
	375 mA at max. 3.4 V LED forward voltage	

6.3 Accu-NiMh

2.2 Ah

Battery voltage/cell	1.2 V
Cell type	Cs
Case temperature range to ensure 4 years design life	+5 °C to +50 °C
Max. short term battery case temperature (shorter than 1 month over the battery lifetime)	70 °C
Max. number discharge cycles	4 cycles per year plus 30 cycles during commissioning
Max. storage time	12 months

6.4 Accupack-NiMH

2.2 Ah

Battery voltage/cell	1.2 V
Cell type	Cs
Ambient temperature range to ensure 4 years design life tc point	+5 °C to +35 °C +40 °C
Max. short term battery case temperature (shorter than 1 month over the battery lifetime)	70 °C
Max. number discharge cycles	4 cycles per year plus 4 cycles during commissioning
Max. storage time	12 months

6.5 Wiring batteries

Connection method: 4.8 x 0.5 mm spade tag welded to end of cell

For stick packs this connection is accessible after the battery caps have been fitted.

To inhibit inverter operation disconnect the batteries by removing the connector from the battery spade tag.

For further information refer to corresponding battery datasheet.

6.6 Short-circuit protection

In case of a short circuit the battery protection opens the connection to the driver and the output is therefore free of voltage. The output will be reactivated again when the short circuit is removed.

6.7 Storage, installation and commissioning

Relevant information about storage conditions, installation and commissioning are provided in the battery datasheets.

7. Miscellaneous

7.1 Maximum number of switching cycles

All LED drivers are tested with 50,000 switching cycles.
The actually achieved number of switching cycles is significantly higher.

7.2 Mains-connected transformers

The EM powerLED does not contain mains-connected windings of transformers.

7.3 Additional information

Additional technical information at www.tridonic.com → Technical Data

Guarantee conditions at www.tridonic.com → Services

Lifetime declarations are informative and represent no warranty claim.
No warranty if device was opened.