

# GARDENSTONE

Redefining Outdoor Planters

Gardenstone Inc  
2851 Hwy 7, Concord ON, L4K 1W2  
1 800-209-0917  
sales@gardenstonemfg.com  
www.gardenstonemfg.com

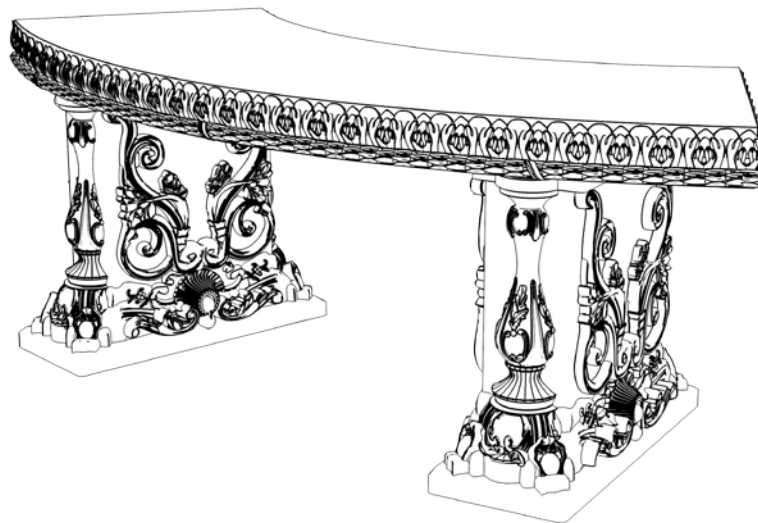
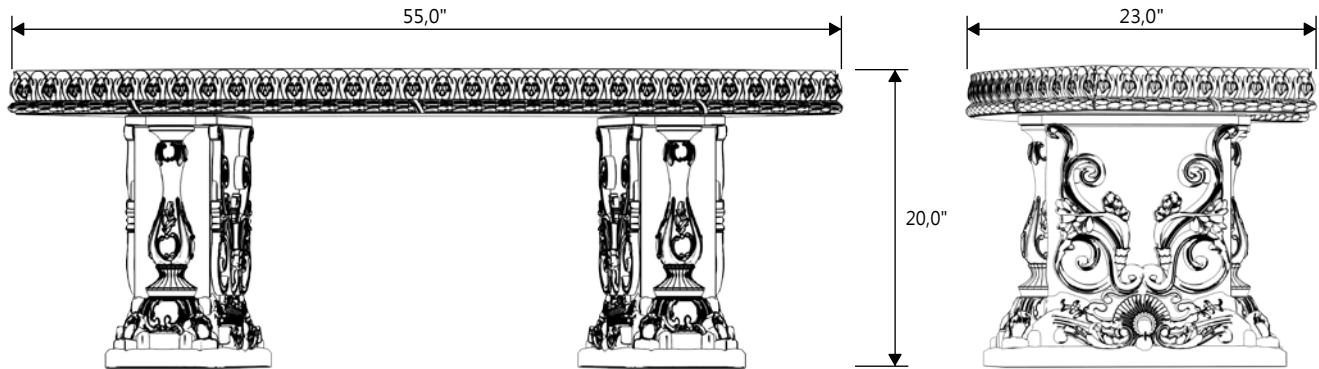

## ALLEGRA BENCH CURVED

1555

WEIGHT: 330 LBS

NOTE: ALL INFORMATION ENCLOSED WAS CURRENT AT THE TIME OF DEVELOPMENT, BUT SHOULD BE REVIEWED BY THE PRODUCT MANUFACTURER TO BE CONSIDERED ACCURATE.

# GARDENSTONE

Redefining Outdoor Planters

Gardenstone Inc  
2851 Hwy 7, Concord ON, L4K 1W2  
1 800-209-0917  
sales@gardenstonemfg.com  
www.gardenstonemfg.com

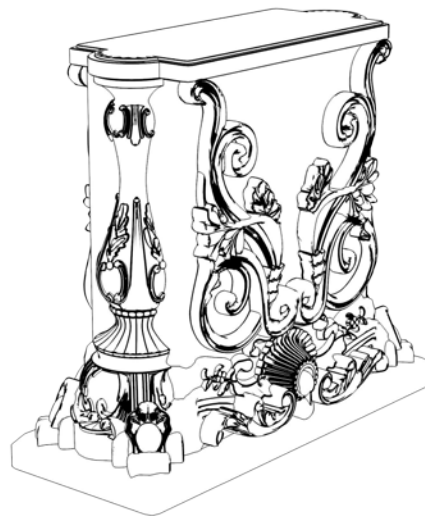
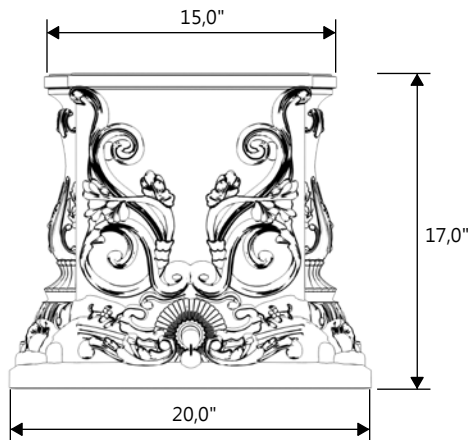

ALLEGRA LEG ONLY

1550-A

NOTE: ALL INFORMATION ENCLOSED WAS CURRENT AT THE TIME OF DEVELOPMENT, BUT SHOULD BE REVIEWED BY THE PRODUCT MANUFACTURER TO BE CONSIDERED ACCURATE.

# GARDENSTONE

Redefining Outdoor Planters

Gardenstone Inc  
2851 Hwy 7, Concord ON, L4K 1W2  
1 800-209-0917  
sales@gardenstonemfg.com  
www.gardenstonemfg.com

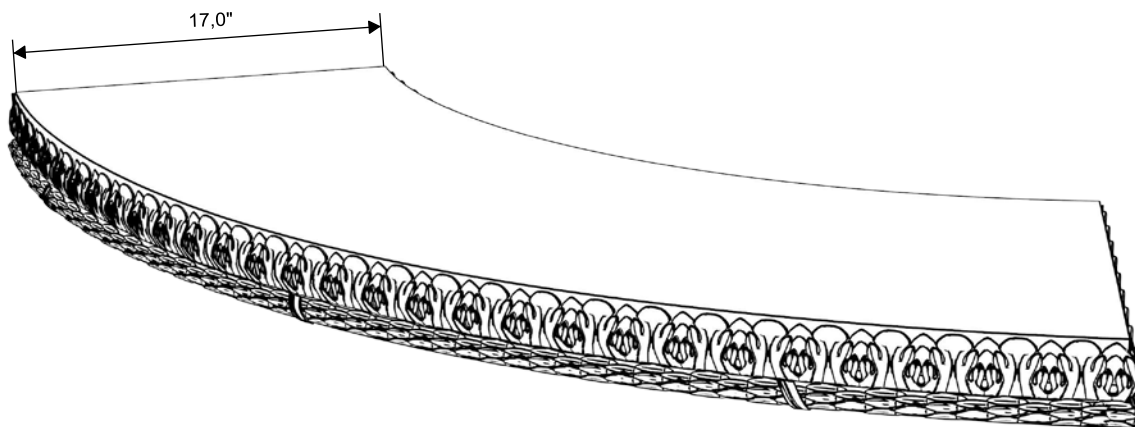
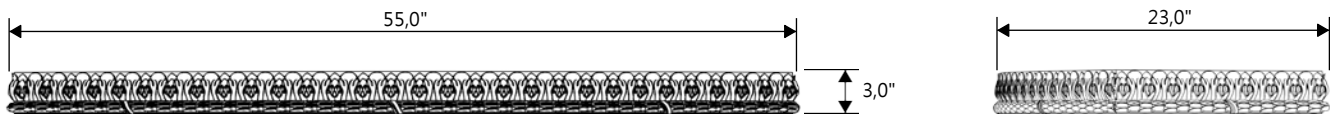

CURVED TOP ONLY

9020

NOTE: ALL INFORMATION ENCLOSED WAS CURRENT AT THE TIME OF DEVELOPMENT, BUT SHOULD BE REVIEWED BY THE PRODUCT MANUFACTURER TO BE CONSIDERED ACCURATE.

# GARDENSTONE

Redefining Outdoor Planters

Gardenstone Inc  
2851 Hwy 7, Concord ON, L4K 1W2  
1 800-209-0917  
sales@gardenstonemfg.com  
www.gardenstonemfg.com

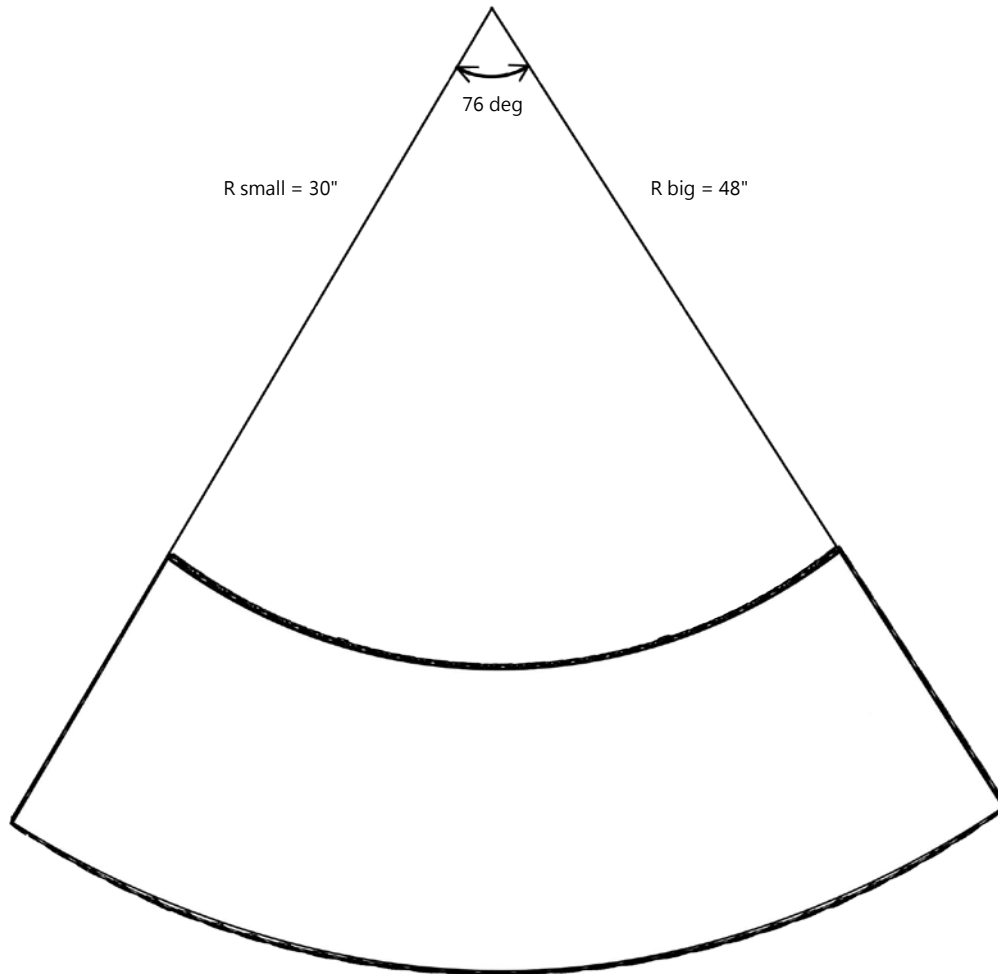

CURVED TOP ONLY

9020

NOTE: ALL INFORMATION ENCLOSED WAS CURRENT AT THE TIME OF DEVELOPMENT, BUT SHOULD BE REVIEWED BY THE PRODUCT MANUFACTURER TO BE CONSIDERED ACCURATE.