

東莞永力電業有限公司

YUNG LI CO., LTD

Da Pu Industrial Zone, Gang Zi, Changping Town,
Dong Guan City, Guangdong 523571 China.P.R.C

TEL:0769-83396797~8

FAX:0769-83396796

E-mail: sales@yung-li.com

Description: YP-80/YC-14

Customer: SIGNAL+POWER

Parts No. : P-8014-06B

Draw No. :

REVISION RECORD

| | | |
|---|--|--|
| 1 | | |
| 2 | | |
| 3 | | |
| 4 | | |
| 5 | | |

| YUNG LI | |
|---------|-------------|
| CHECKED | PREPARED BY |
| | |

| CUSTOMER | APPROVED |
|----------|----------|
| | |

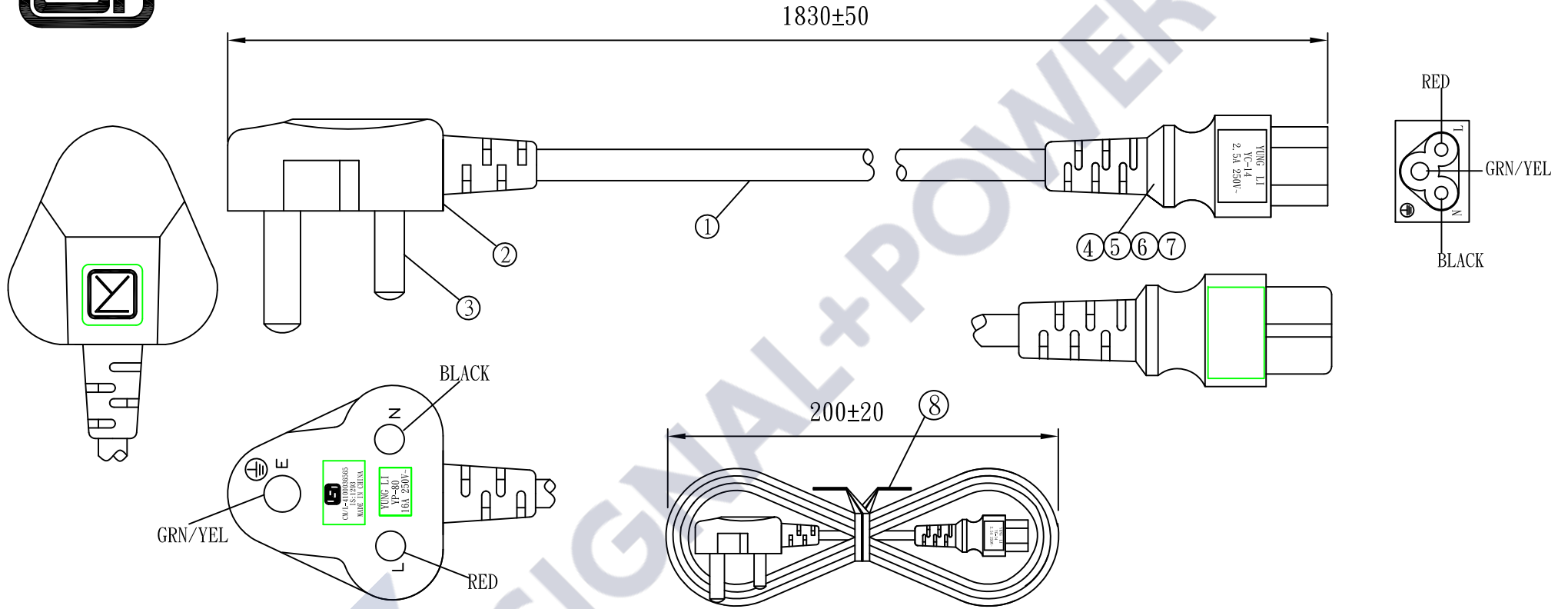

| NO. | SPECIFICATION | QTY | REMARK |
|-----|---|--------|--------|
| 1 | Y Y 3G 0.75mm ² CIRCULAR BLACK | 1PC | |
| 2 | YP-80 PVC PLASTIC:50P BLACK | 50g/PC | |
| 3 | FRAME WHITE | 1PC | |
| 4 | YC-14 PVC PLASTIC:50P BLACK | 18g/PC | |
| 5 | TER:98714PS-0 | 2PCS | |
| 6 | TER:98732PS-0 | 1PC | |
| 7 | YC-14 H. S. G | 1PC | |
| 8 | MINI TIE:L=130mm BLACK | 1PC | |

Marking:

Yung Li Co. Ltd. Y Y 3C 0.75mm² CIRCULAR 1100V IS 694 CM/L-4041337 MADE IN CHINA

| TOLERANCE >0±0.30 >1.0±0.50 >10.0±1.0 >20.0±2.0 Angle: ±1° | APPROVED | DATE | SIGNAL+POWER | | | | |
|--|-------------|-------------|--------------|----------|------------|------|----|
| | CHECKED | DATE | | | | | |
| | DRAWN | DATE | CUSTOMER | | | | |
| | TYPE | YP-80/YC-14 | | P/N | P-8014-06B | | |
| DRAWING NO. | SP140320-06 | REV | B | MATERIAL | P. V. C | UNIT | mm |
| | | | | SCALE | | | |

IA16A3 and also known as IS1293 or BS546

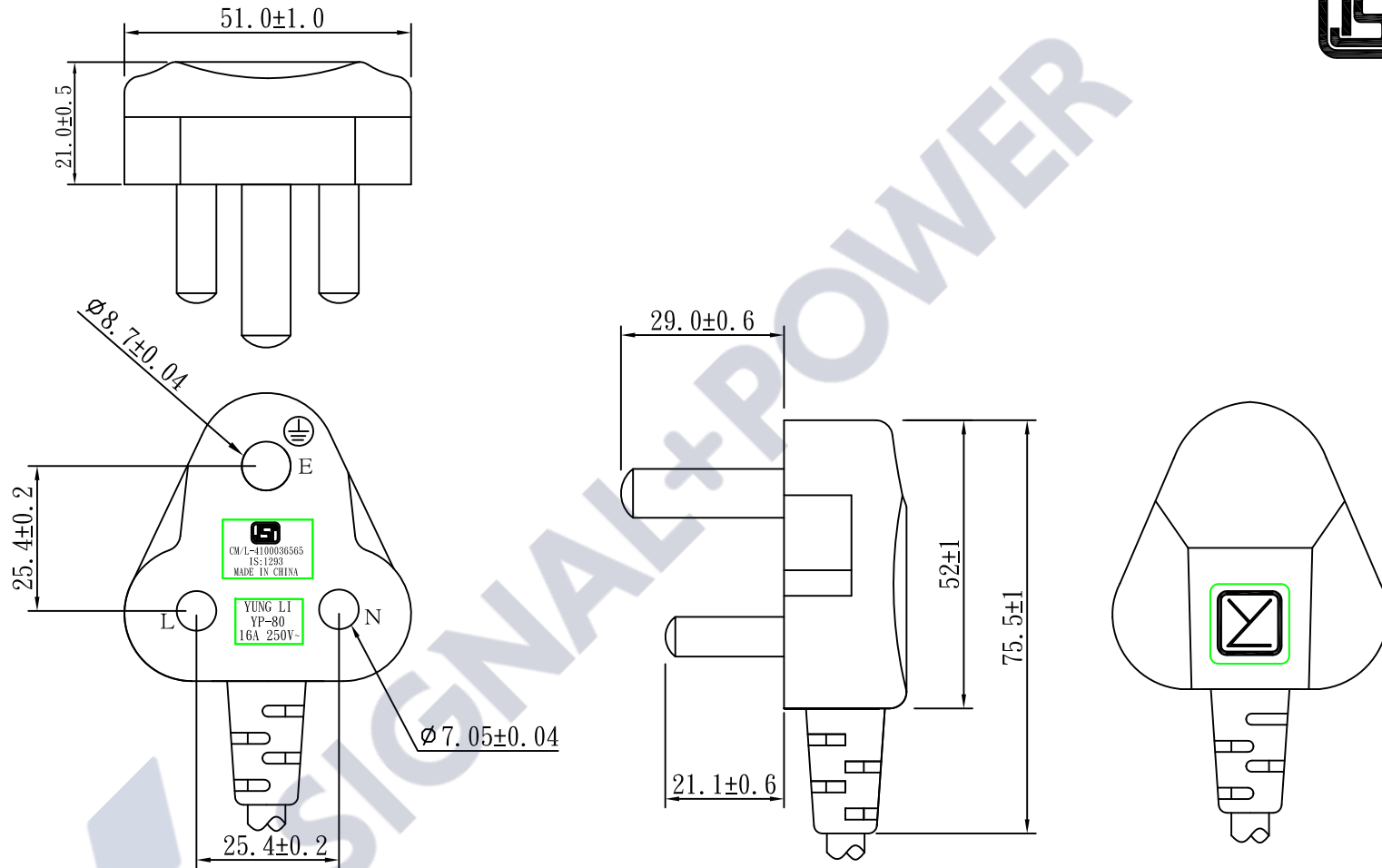

| | | | | | | | | |
|--|-------------|------------|------|----------|------------------|---------|------|----|
| TOLERANCE >0±0.30 >1.0±0.50 >10.0±1.0 >20.0±2.0 Angle: ±1° | APPROVED | | DATE | | YUNG LI CO., LTD | | | |
| | CHECKED | | DATE | | | | | |
| | DRAWN | HAIYAN | DATE | 17.08.01 | | | | |
| | TYPE | YP-80(16A) | | | CUSTOMER | | | |
| | DRAWING NO. | | REV | B | MATERIAL | P. V. C | UNIT | mm |
| | | | | SCALE | | | | |

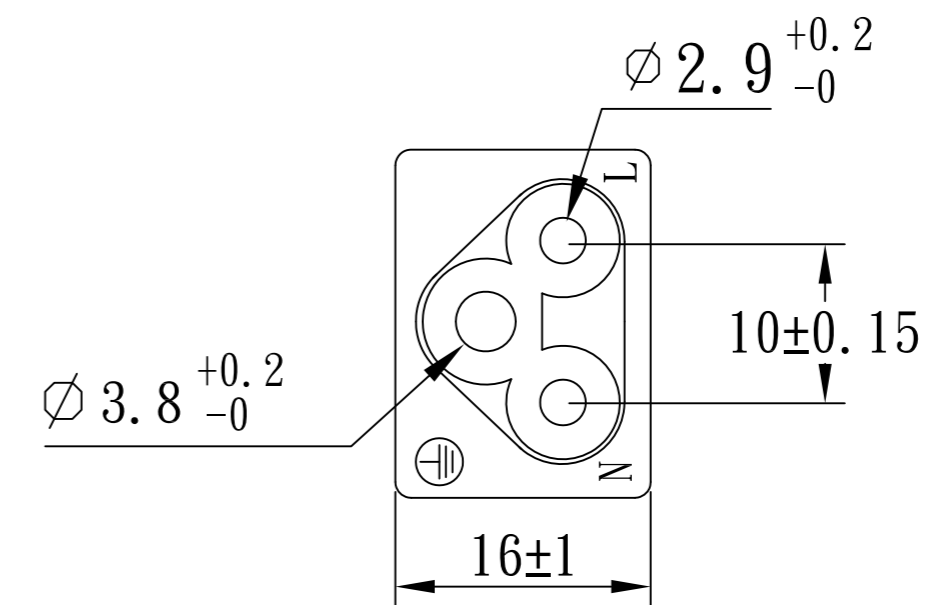
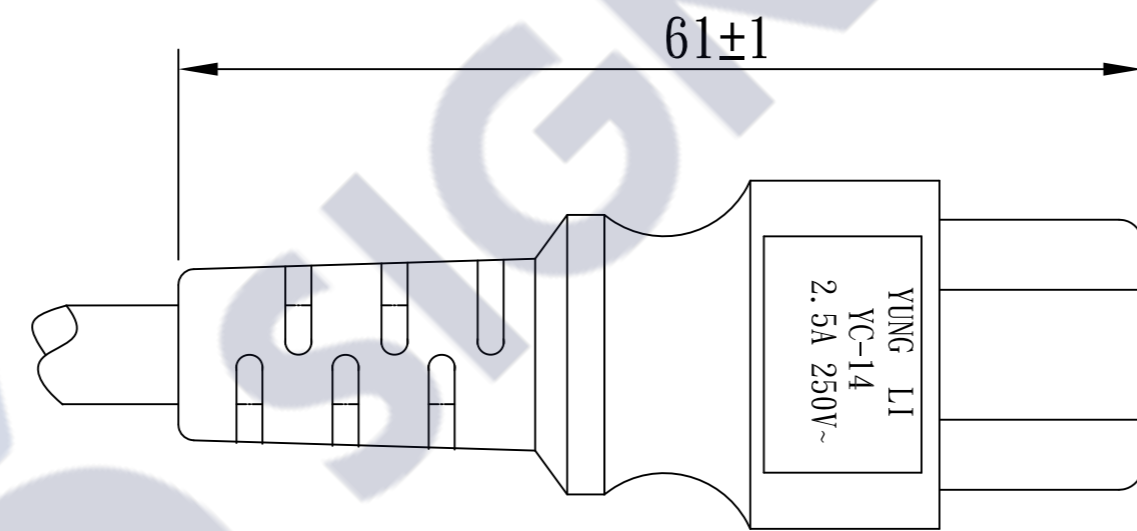
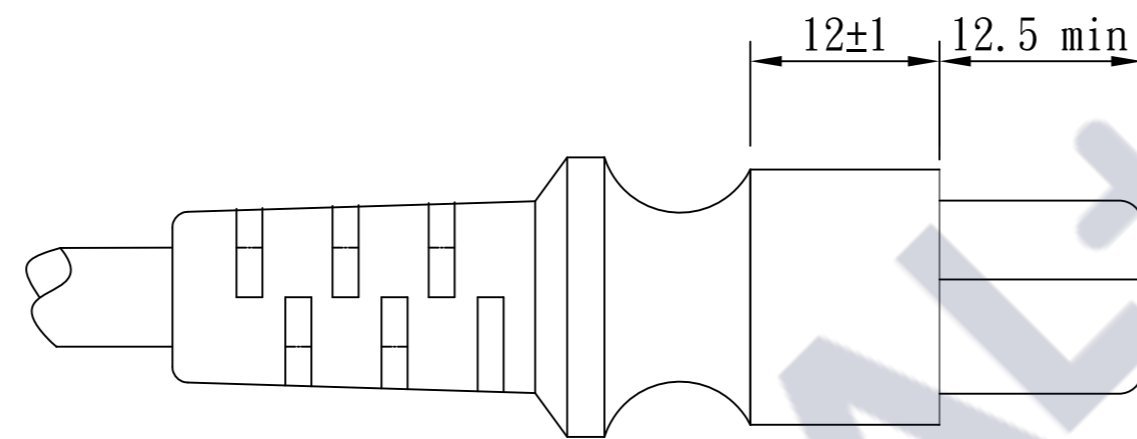
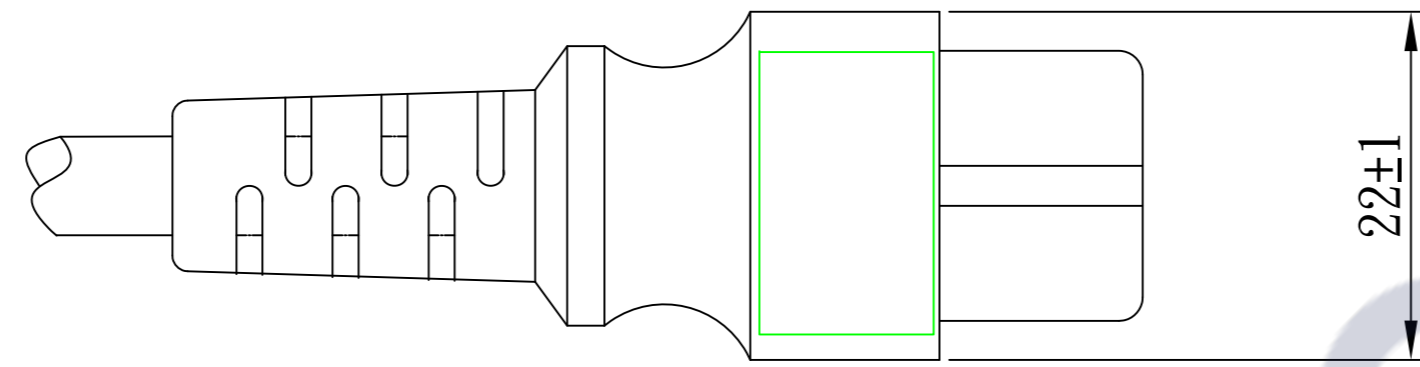

| | | | | | | | | |
|--|------------|-------|------|--|-------------------|-------|------|----|
| TOLERANCE >0±0.30 >1.0±0.50 >10.0±1.0 >20.0±2.0 Angle: ±1° | APPROVED | | DATE | | YUNG LI CO., LTD. | | | |
| | CHECKED | | DATE | | | | | |
| | DRAWN | | DATE | | | | | |
| | TYPE | YC-14 | | | P/N | | | |
| | DRAWING NO | | | | MATERIAL | P.V.C | UNIT | mm |
| | | | | | SCALE | 1:1 | | |

YUNG LI CO., LTD

SPECIFICATION

| | | | |
|-----------|-------|----------------------------------|-------------|
| Yung Li | Style | PVC FLEXIBLE CORDS | Document No |
| 2015.11.6 | | | |
| Edition | Size | Y Y 3C 0.75mm² | Page |
| A | | | 1/2 |

1. Standard: IS 694

2. Construction & Dimension

| | Item | Specification |
|---------------|--------------------------------|-------------------------|
| Conductor | Size | 3G 0.75mm ² |
| | Material | Annealed Bare Copper |
| | Construction | 24/ § 0.202±0.01 |
| Insulation | Material | PVC |
| | Minimum Average Thickness | 0.60mm |
| | Minimum Thickness at any point | 0.48mm |
| | Diameter | 2.35 ± 0.10 |
| | Identification | RED,BLACK, Yellow/Green |
| Core Assembly | Core Twist | 3-Core |
| | Filler | NA |
| | Assembly Pair | NA |
| Taping | Mylar Foil | NA |
| Shielded | A1-Mylar Foil | NA |
| Drain | Material | NA |
| | Construction | NA |
| Jacket | Material | PVC |
| | Minimum Average Thickness | 0.9mm |
| | Minimum Thickness at any point | 0.72mm |
| | Overall Diameter(Approx) | 6.9 ± 0.15 |
| | Color | Any Color |

Marking:

Yung Li Co. Ltd. Y Y 3C 0.75mm² CIRCULAR 1100V IS 694  CM/L-4041337 MADE IN CHINA

YUNG LI CO., LTD

SPECIFICATION

| | | | |
|-----------|-------|----------------------------------|-------------|
| Yung Li | Style | PVC FLEXIBLE CORDS | Document No |
| 2015.11.6 | | | YL-V01001 |
| Edition | Size | Y Y 3C 0.75mm² | Page |
| A | | | 2/2 |

4. Electrical & Physical Properties

| Item | Specification | | |
|--------------------------------|-----------------------------|-----------------------------|------------------------------|
| Rating Voltage | 70°C 300/500V | | |
| Conductor resistance(AT 20°C) | 26.0Ω/Km MAX | | |
| Insulation Resistance(AT 70°C) | 0.011MΩ/Km Min | | |
| Dielectric Strength | AC 2.0 KV / 15 min No Break | | |
| Spark Test | 6.0KV | | |
| Insulation | Unaged | Tensile Strength | 1.02 kgf/mm ² min |
| | | Elongation | 150% Min |
| | Aged | Tensile Strength | 80~120% (80°C x168hrs) |
| | | Elongation | 80~120% (80°C x168hrs) |
| | Loss of mass Test | | 2.0mg/cm ² (max) |
| | Jacket | Unaged | Tensile Strength |
| Elongation | | | 150% Min |
| Aged | | Tensile Strength | 80~120% (80°C x168hrs) |
| | | Elongation | 80~120% (80°C x168hrs) |
| Loss of mass Test | | 2.0mg/cm ² (max) | |
| Deformation Test | | 70±2°C X 4hr ≤ 50% | |
| Cold Bend Test | | -15°C x 1hr No Crack | |
| Heat Shock Test | | 150±2°C x 1hr No Crack | |

Graph:

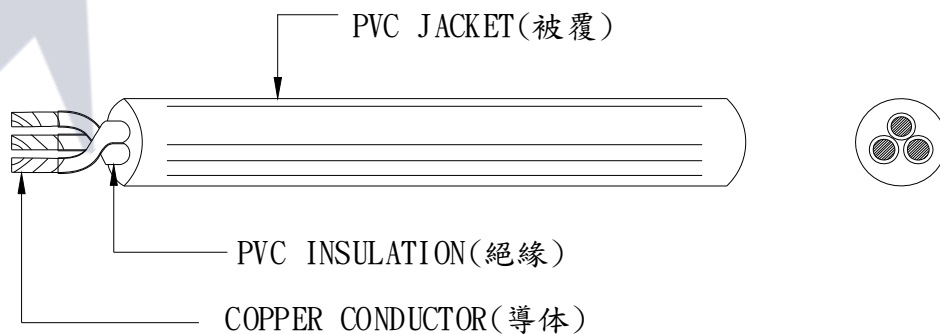



AIRMAIL/SPEED POST

Our Ref: FMCD-CM/L-4100036565

20-07-2020

Subject: RENEWAL OF CERTIFICATION MARKS LICENCE NO. CM/L- 4100036565
AS PER IS 1293: 2019

M/s Dongguan Yung Li Co. Ltd.,
Da Pu Industrial Zone, Gangzi,
ChangPing Town, DongGuan City
Changping District, GuangDong State,
P.R. China - 523571

Dear Sir,

With reference to your application for renewal of the above mentioned Certification Marks Licence, we are pleased to inform you that it has been renewed from 19/07/2020 to 18/07/2025.

It may please be noted that your licence shall expire at the end of the above mentioned period. You are, therefore, requested to send your application along with fee for its renewal at least one month before the expiry of the licence.

It may also be noted that the Performance Bank Guarantee of US\$ 10,000.00 submitted by you is valid upto 11.09.2021. Since as per the revised guidelines the Bank Guarantee should have a validity of six months more than the validity of the licence therefore, you are advised to get the validity of the Bank Guarantee extended accordingly. You are directed to submit revised Performance Bank Guarantee before its validity date, failing which we may be constrained to take action such as stop marking/cancellation of the BIS licence as enshrined in the BIS (Certification) Regulation, 2016. Please ensure extension of PBG as early as possible.

The endorsement sheet regarding revision of marking fee and renewal of licence are enclosed. This may be annexed to the original licence document available with you.

Thanking you.

Yours faithfully,

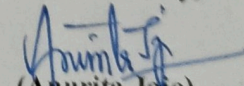
(Anurita Jojo)
Sc. D (FMCD)

Encl: As above

Copy to:

Mr. Prakash Taunk
239, Nagpur Road,
Madan Mahal, Jabalpur,
M.P. - 482001



भारतीय मानक ब्यूरो
BUREAU OF INDIAN STANDARDS

FMCD

Address : Manak Bhavan, 9 Bahadur Shah
Zafar Marg, New Delhi, 110002
Phones : 91-11-23239382
Fax : 91-11-23239382
E-mail : fmcd@bis.org.in
Web : <http://www.bis.org.in>

ATTACHMENT TO LICENCE NO. CM/L- 4100036565

| CML/NO | NAME OF THE LICENSEE WITH THE FACTORY ADDRESS | NAME OF THE PRODUCT | INDIAN STANDARD NO. |
|------------|--|---|---------------------|
| 4100036565 | M/s Dongguan Yung Li Co. Ltd., Da Pu Industrial Zone, Gangzi, ChangPing Town, DongGuan City Changping District, GuangDong State, P.R. China - 523571 | Plugs and socket- outlets of rated voltage upto & including 250 volts and rated current upto & including 16 amperes - Specification | IS 1293 : 2019 |

ENDORSEMENT NO. 04 DATED 20-07-2020

Whereas, the licence was valid upto Eighteenth July Two Thousand Twenty,

Now, consequent upon renewal, the validity of the licence given in endorsement No. 01 has been extended from Nineteenth July Two Thousand Twenty to Eighteenth July Two Thousand Twenty Five.

Other terms and conditions of Licence remain the same.

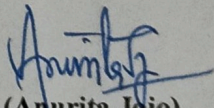
(Anurita Jojo)
Sc. D (FMCD)



AIRMAIL/SPEED POST

Our Ref: FMCD-CM/L-4041337

27-08-2020

Subject: RENEWAL OF CERTIFICATION MARKS LICENCE NO. CM/L- 4041337
AS PER IS 694:2010

M/s Dongguan Yung Li Co. Ltd.,
DaPu Industrial Zone,
Gangzi Changping Town,
Dongguan City,
Guangdong - 523571
China

Dear Sir,

With reference to your application for renewal of the above mentioned Certification Marks Licence, we are pleased to inform you that it has been renewed from 01/09/2020 to 31/08/2025.

It may please be noted that your licence shall expire at the end of the above mentioned period. You are, therefore, requested to send your application along with fee for its renewal at least one month before the expiry of the licence.

It may also be noted that the Performance Bank Guarantee of US\$ 10,000.00 submitted by you is valid upto 11-09-2021. Since as per the revised guidelines the Bank Guarantee should have a validity of six months more than the validity of the licence therefore, you are advised to get the validity of the Bank Guarantee extended accordingly. You are directed to submit revised Performance Bank Guarantee before its validity date, failing which we may be constrained to take action such as stop marking/cancellation of the BIS licence as enshrined in the BIS (Conformity Assessment) Regulation, 2018. Please ensure extension of PBG as early as possible.

The endorsement sheet regarding renewal of licence is enclosed. This may be annexed to the original licence document available with you.

Thanking you.

Yours faithfully,

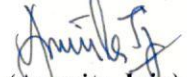
(Anurita Jojo)
Sc. D (FMCD)

Encl: As above

Copy to: **Mr. Ravinder Madan**
Planet Standards Certification Advisors
63, Bhagwan Buddha Apt, Parwana Road,
Pitampura, Delhi- 110034



भारतीय मानक ब्यूरो
BUREAU OF INDIAN STANDARDS

Address : Manak Bhavan, 9 Bahadur Shah
Zafar Marg, New Delhi, 110002
Phones : 91-11-23239382
Fax : 91-11-23239382
E-mail : fmcd@bis.org.in
Web : <http://www.bis.org.in>

FMCD

ATTACHMENT TO LICENCE NO. CM/L- 4041337

| CML/NO | NAME OF THE LICENSEE WITH THE FACTORY ADDRESS | NAME OF THE PRODUCT | INDIAN STANDARD NO. |
|---------|--|---|---------------------|
| 4041337 | M/s Dongguan Yung Li Co. Ltd., DaPu Industrial Zone, Gangzi Changping Town, Dongguan City, Guangdong - 523571 China | PVC insulated unsheathed and sheathed cables/cords with rigid & flexible conductor for rated voltages upto & including 1100 V | IS 694 : 2010 |

ENDORSEMENT NO. 10 DATED 27-08-2020

Consequent to the change of name and address of the Authorized Indian Representative, the name and address of the Authorized Indian Representative is as under :-

Mr. Ravinder Madan
Planet Standards Certification Advisors
63, Bhagwan Buddha Aptt, Parwana Road,
Pitampura, Delhi- 110034

Whereas, the licence was valid upto Thirty-first August Two Thousand Twenty,

Now, consequent upon renewal, the validity of the licence given in endorsement no. 09 has been extended from First September Two Thousand Twenty to Thirty-first August Two Thousand Twenty Five.

Other terms and conditions of Licence remain the same.

(Anurita Jojo)
Sc. D (FMCD)