

東莞永力電業有限公司

YUNG LI CO., LTD

Da Pu Industrial Zone, Gang Zi, Changping Town,
Dong Guan City, Guangdong 523571 China.P.R.C

TEL:0769-83396797~8

FAX:0769-83396796

E-mail: sales@yung-li.com

Description: YP-33/YC-12

Customer: SIGNAL+POWER

Parts No. : P-3312-XXX-18

Draw No. :

REVISION RECORD

1		
2		
3		
4		
5		

YUNG LI	
CHECKED	PREPARED BY

CUSTOMER	APPROVED

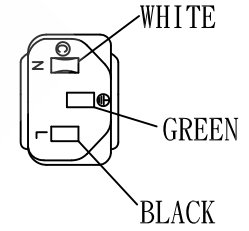
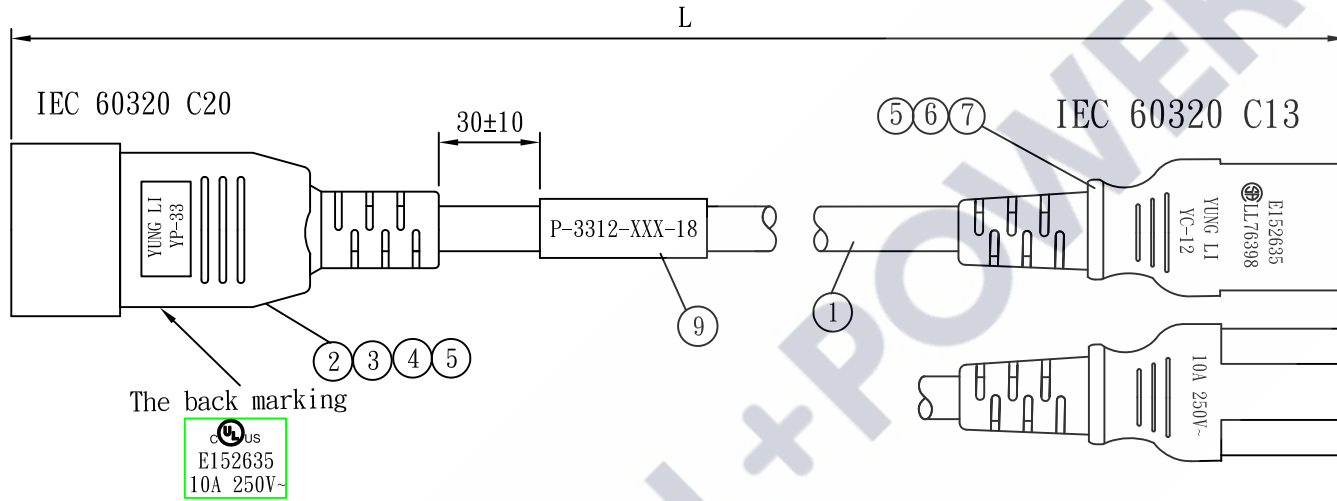
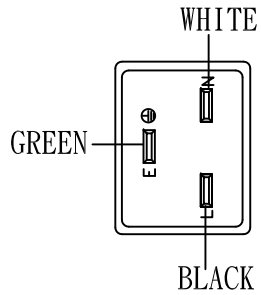

L : base on the list
Color : see attached list

	36	48	60	72
Length:"L"	3FT	4FT	5FT	6FT
	915mm	1220mm	1524mm	1829mm

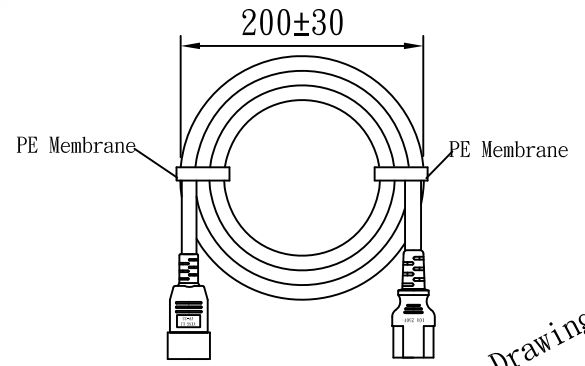
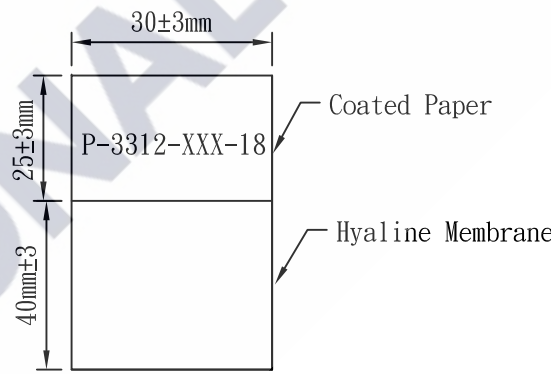

Sample Drawing No. :
SP210324-10

NO.	SPECIFICATION	QTY	REMARK
1	SJT 18/3C 105°C	1PC	
2	TER:97606BS-1	2PCS	
3	TER:97607BS-1	1PC	
4	YP-33 INNER BODY	1PC	
5	YP-33 PVC PLASTIC:50P	32g/PC	
6	YC-12 PVC PLASTIC:50P	25g/PC	
7	YC-12 INNER BODY	1PC	
8	TER:97740	3PCS	
9	LABEL:(40+25)*30mm	1PC	

Tolerance >0±0.30 >1.0±0.50 >10.0±1.0 >20.0±2.0 Angle: ±1°	Approved		Date		SIGNAL+POWER			
	Checked		Date					
	Drawn	SUKI	Date	21.03.24	Customer			
	Cat. No.	YP-33/YC-12			P/N.	P-3312-XXX-18		
	Drawing No.		Rev.	B	Material	P. V. C	Unit	mm
				Scale				

Part Number List

Power Cord Spec: YP-33+YC-12 SJT 18/3 105°C

BLACK

P-3312-03B-18	03B=3FT (915±30)
P-3312-04B-18	04B=4FT (1220±50)
P-3312-05B-18	05B=5FT (1530±50)
P-3312-06B-18	06B=6FT (1830±50)

RED (GY-49)

P-3312-03RED-18	03RED=3FT (915±30)
P-3312-06RED-18	06RED=6FT (1830±50)

BLUE (PT293C)

P-3312-03BLU-18	03BLU=3FT (915±30)
P-3312-06BLU-18	06BLU=6FT (1830±50)



SIGNAL+POWER



IEC 60320 C20

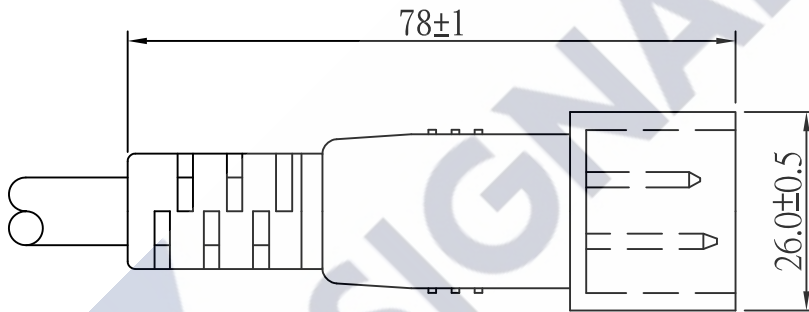
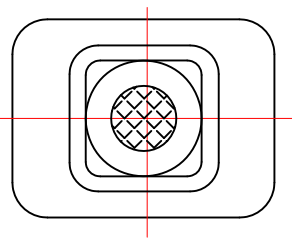
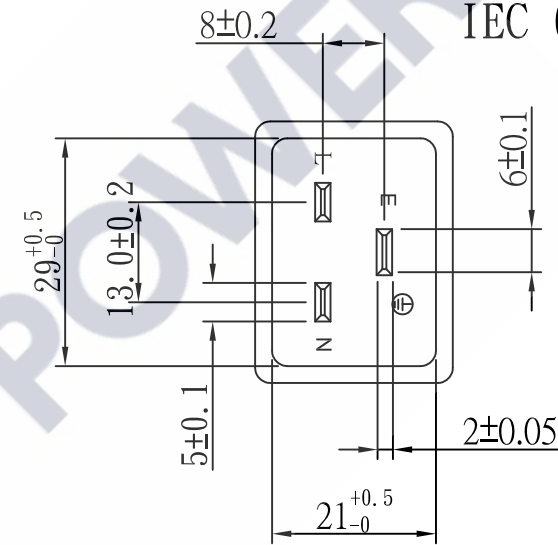
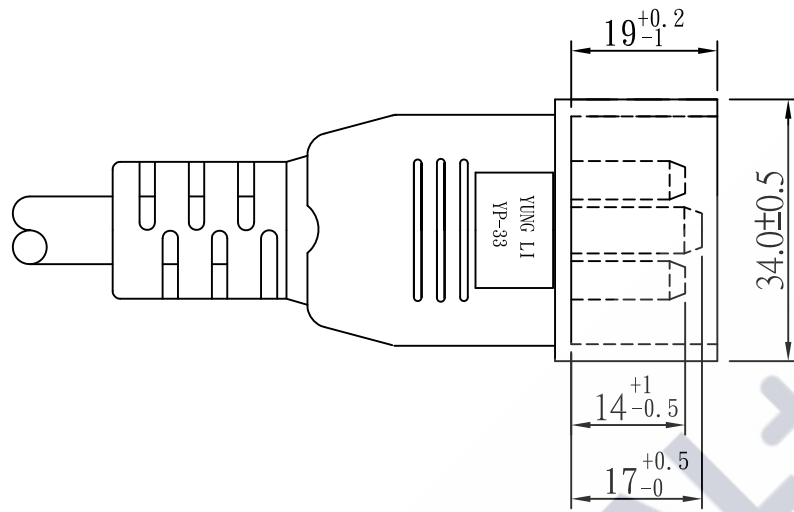

TOLERANCE $>0 \pm 0.30$ $>1.0 \pm 0.50$ $>10.0 \pm 1.0$ $>20.0 \pm 2.0$ Angle: $\pm 1^\circ$	APPROVED		DATE		YUNG LI CO., LTD			
	CHECKED		DATE					
	DRAWN		DATE		CUSTOMER			
	TYPE	YP-33			P/N			
	DRAWING NO.		REV	B	MATERIAL	P. V. C	UNIT	mm
				SCALE	1:1			



IEC60320-C13

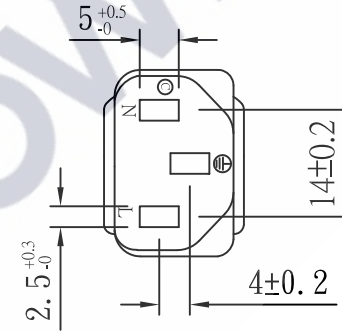
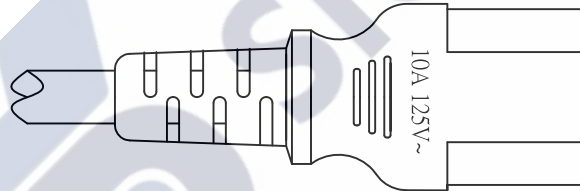
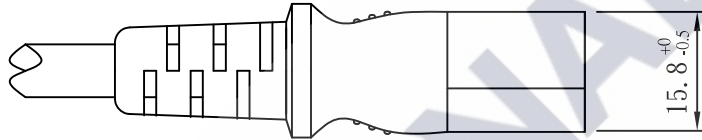
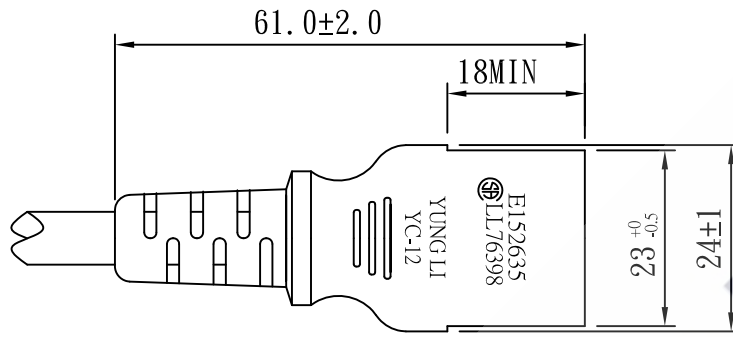

TOLERANCE >0±0.30 >1.0±0.50 >10.0±1.0 >20.0±2.0 Angle: ±1°	APPROVED		DATE		YUNG LI CO., LTD			
	CHECKED		DATE					
	DRAWN		DATE					
	TYPE	YC-12			P/N			
	DRAWING NO.		REV	B	SCALE	1:1	UNIT	mm

YUNG LI CO., LTD

SPECIFICATION

Yung-Li	Style	PVC FLEXIBLE CORDS	Document No
2007.8.02			
Edition	Size	SJT 18/ 3C 105	Page
A			1/2

1. Standard : UL 62 UL 1581

2. Construction & Dimension

	Item	Specification
Conductor	Size	18AWG X 3C
	Material	Annealed Bare Copper
	Construction	41/ 0.16±0.002
Insulation	Material	PVC
	Minimum Average Thickness	0.76mm
	Minimum Thickness at any point	0.69mm
	Diameter	2.75 ± 0.10
	Identification	Black White Green
Core Assembly	Core Twist	3-Core
	Filler	NA
	Assembly Pair	NA
Taping	Mylar Foil	NA
Shielded	A1-Mylar Foil	NA
Drain Wire	Material	NA
	Construction	NA
Jacket	Material	PVC
	Minimum Average Thickness	0.76mm
	Minimum Thickness at any point	0.61mm
	Overall Diameter(Approx)	7.8 ± 0.15
	Color	Any Color

Marking :

YUNG LI (UL) E241374 SJT 3/C 18AWG(0.824mm²) 105 300V VW-1
 CSA 177323 SJT 3/C 18AWG(0.824mm²) 105 300V FT2

YUNG LI CO., LTD

SPECIFICATION

Yung-Li	Style	PVC FLEXIBLE CORDS	Document No
2007.8.02			
Edition	Size	SJT 18/ 3C 105	Page
A			2/2

3. Electrical & Physical Properties			
Item		Specification	
Rating Voltage		300V	
Insulation Resistance		0.76MΩ/Km 15.0 Min	
Dielectric Strength		AC 2.0KV/1 min No Crack	
Spark Test		6KV/0.15 Sec	
Insulation	Unaged	Tensile Strength	1500 lbs/in ² min
		Elongation	100% Min
	Aged	Tensile Strength	Min 85%(136±1 x168hrs)
		Elongation	Min 65%(136±1 x168hrs)
Jacket	Unaged	Tensile Strength	1500 lbs/in ² min
		Elongation	100% Min
	Aged	Tensile Strength	Min 85%(136±1 x168hrs)
		Elongation	Min 45%(136±1 x168hrs)
Deformation Test		121±1 m X 1hr 50%	
Cold Bend Test		-20 x 4hr No Crack	
Heat Shock Test		121±1 x 1hr No Crack	

Graph:

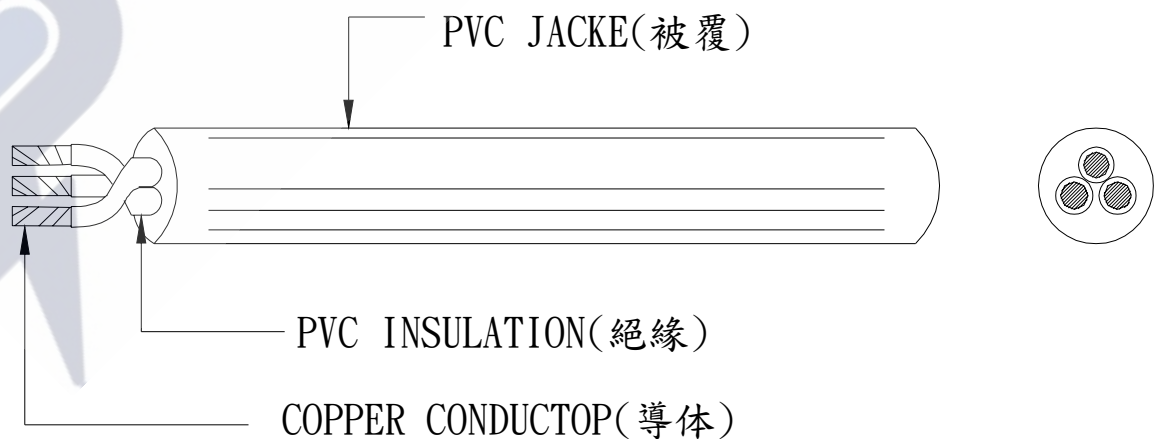

ELBZ7.E152635 - Cord Sets and Power-supply Cords Certified for Canada

Cord Sets and Power-supply Cords Certified for Canada

See General Information for Cord Sets and Power-supply Cords Certified for Canada

YUNG LI CO LTD

7F-12 NO 99 SEC 1 XINTAI 5TH RD
XIZHI DISTRICT
NEW TAIPEI, 22175 TAIWAN

Power-supply cords

E152635

Cat. No.	ANSI/NEMA WD6 Config	Cord AWG	Cord Type	Electrical Rating Amps V
YP-11	1-15	18/2	SPT-1, SPT-2, SPT-3, NISPT-2, SVT, SVTO, SJT, SJTW, SJTO, SJTOW (All TPE material), SPT-1, SPT-1W, NISPT-1, SPT-2, SPT-2W, NISPT-2, SPT-3, HPN, SVT, SVTO, SJT, SJTW, SJTO, SJTOW, SV, SVO, SJ, SJO, SJOW, SJOOW, EVT, EVJT, EVE, EVJE	7 or 10/125
		17/2	SVT, SVTO (All TPE material), SVT, SVTO, SV, SVO, SJ, SJO, SJOW, SJOOW, EVT, EVJT, EVE, EVJE	12/125
		16/2	SPT-2, SPT-3, NISPT-2, SVT, SVTO, SJT, SJTW, SJTO, SJTOW (All TPE material), SPT-2, SPT-2W, NISPT-2, SPT-3, SVT, SVTO, SJT, SJTW, SJTO, SJTOW, SV, SVO, SJ, SJO, SJOW, SJOOW, EVT, EVJT, EVE, EVJE	13/125
		16/2	HPN	15/125
		14/2	SPT-3, SJT, SJTW, SJTO, SJTOW (All TPE material), SPT-3, SJT, SJTW, SJTO, SJTOW, SJ, SJO, SJOW, SJOOW, EVT, EVJT, EVE, EVJE	15/125
YP-11W	1-15P	18/2	SPT-1, SPT-2, SPT-3, NISPT-2, SVT, SVTO, SJT, SJTW, SJTO, SJTOW (All TPE material), SPT-1, SPT-1W, NISPT-1, SPT-2, SPT-2W, NISPT-2, SPT-3, HPN, SVT, SVTO, SJT, SJTW, , SJTO, SJTOW, SV, SVO, SJ, SJO, SJOW, SJOOW, EVT, EVJT, EVE, EVJE	7 or 10/125
		17/2	SVT, SVTO (All TPE material), SVT, SVTO, SV, SVO, SJ, SJO, SJOW, SJOOW, EVT, EVJT, EVE, EVJE	12/125
		16/2	SPT-2, SPT-3, NISPT-2, SVT, SVTO, SJT, SJTW, SJTO, SJTOW (All TPE material), SPT-2, SPT-2W, NISPT-2, SPT-3, SVT, SVTO, SJT, SJTW, SJTO, SJTOW, SV, SVO, SJ, SJO, SJOW, SJOOW, EVT, EVJT, EVE, EVJE	13/125
		16/2	HPN	15/125
		14/2	SPT-3, SJT, SJTW, SJTO, SJTOW (All TPE material), SPT-3, SJT, SJTW, SJTO, SJTOW, SJ, SJO, SJOW, SJOOW, EVT, EVJT, EVE, EVJE	15/125

		14/3	SVT, SJT, SJT Shielded, SJTW, SJTO, SJTOW (All TPE material), SJT, SJT Shielded, SJTW, SJTO, SJTOW, EVT, EVJT, EVE, EVJE	15/250
YP-33	IEC C20	18/3	SJT, SJTW, SJTO, SJTOW, SJTOO, SJTOOW, ST, STW, STOW, STOOW (All TPE material, Shielded and Non-shielded for all types), SJT, SJTW, SJTO, SJTOO, SJTOW, SJTOOW, SJ, SJO, SJOO, SJOW, SJOOW, ST, STW, STOW, STOOW, S, SO, SOW, SOO, SOOW (Shielded or Non-shielded for all types), EVT, EVJT, EVE, EVJE	2.5, 7 or 10/125 or 250
		17/3	SJT, SJTW, SJTO, SJTOW, SJTOO, SJTOOW, ST, STW, STOW, STOOW (All TPE material, Shielded and Non-shielded for all types), SJT, SJTW, SJTO, SJTOO, SJTOW, SJTOOW, SJ, SJO, SJOO, SJOW, SJOOW, ST, STW, STOW, STOOW, S, SO, SOW, SOO, SOOW (Shielded or Non-shielded for all types), EVT, EVJT, EVE, EVJE	12/125 or 250
		16/3	SJT, SJTW, SJTO, SJTOW, SJTOO, SJTOOW, ST, STW, STOW, STOOW (All TPE material, Shielded and Non-shielded for all types), SJT, SJTW, SJTO, SJTOO, SJTOW, SJTOOW, SJ, SJO, SJOO, SJOW, SJOOW, ST, STW, STOW, STOOW, S, SO, SOW, SOO, SOOW (Shielded or Non-shielded for all types), EVT, EVJT, EVE, EVJE	13/125 or 250
		15/3	SJT, SJTW, SJTO, SJTOW, SJTOO, SJTOOW, ST, STW, STOW, STOOW (All TPE material, Shielded and Non-shielded for all types), SJT, SJTW, SJTO, SJTOO, SJTOW, SJTOOW, SJ, SJO, SJOO, SJOW, SJOOW, ST, STW, STOW, STOOW, S, SO, SOW, SOO, SOOW (Shielded or Non-shielded for all types), EVT, EVJT, EVE, EVJE	16/125 or 250
		14/3	SJT, SJTW, SJTO, SJTOW, SJTOO, SJTOOW, ST, STW, STOW, STOOW (All TPE material, Shielded and Non-shielded for all types), SJT, SJTW, SJTO, SJTOO, SJTOW, SJTOOW, SJ, SJO, SJOO, SJOW, SJOOW, ST, STW, STOW, STOOW, S, SO, SOW, SOO, SOOW (Shielded or Non-shielded for all types), EVT, EVJT, EVE, EVJE	15, 16/125 or 250
		12/3	SJT, SJTW, SJTO, SJTOW, SJTOO, SJTOOW, ST, STW, STOW, STOOW (All TPE material, Shielded and Non-shielded for all types), SJT, SJTW, SJTO, SJTOO, SJTOW, SJTOOW, SJ, SJO, SJOO, SJOW, SJOOW, ST, STW, STOW, STOOW, S, SO, SOW, SOO, SOOW (Shielded or Non-shielded for all types), EVT, EVJT, EVE, EVJE	20/125 or 250
YP-33L	IEC C20	18/3	SJT, SJTW, SJTO, SJTOW, SJTOOW, ST, STW, STOW, STOOW (All TPE material), SJT, SJTW, SJTO, SJTOW, SJTOOW, SJ, SJO, SJOO, SJOW, SJOOW, ST, STW, STOW, STOOW, S, SO, SOW, SOO, SOOW, EVT, EVJT, EVE, EVJE	2.5, 7 or 10/125 or 250
		17/3	SJT, SJTW, SJTO, SJTOW, SJTOOW, ST, STW, STOW, STOOW (All TPE material), SJT, SJTW, SJTO, SJTOW, SJTOOW, SJ, SJO, SJOO, SJOW, SJOOW, ST, STW, STOW, STOOW, S, SO, SOW, SOO, SOOW, EVT, EVJT, EVE, EVJE	12/125 or 250
		16/3	SJT, SJTW, SJTO, SJTOW, SJTOOW, ST, STW, STOW, STOOW (All TPE material), SJT, SJTW, SJTO, SJTOW, SJTOOW, SJ, SJO, SJOO, SJOW, SJOOW, ST, STW, STOW, STOOW, S, SO, SOW, SOO, SOOW, EVT, EVJT, EVE, EVJE	13/125 or 250

		8/3	S, SO, SOW, SOO, SOOW, ST, STW, STO, STOW, STOO, STOOW	30/277 Vac
YP-12R, YP-12R-1	5-15P	18/3	SJ, SJO, SJOW, SJOO, SJOOW, S, SO, SOW, SOO, SOOW, SVT, SVTO, SJT, SJTW, SJTO, SJTOW, SJTOO, SJTOOW, ST, STW, STO, STOW, STOO, STOOW	10/125
		16/3	SJ, SJO, SJOW, SJOO, SJOOW, S, SO, SOW, SOO, SOOW, SJT, SJTW, SJTO, SJTOW, SJTOO, SJTOOW, ST, STW, STO, STOW, STOO, STOOW	13/125
		14/3	SJ, SJO, SJOW, SJOO, SJOOW, S, SO, SOW, SOO, SOOW, SJT, SJTW, SJTO, SJTOW, SJTOO, SJTOOW, ST, STW, STO, STOW, STOO, STOOW	15/125
		12/3	SJ, SJO, SJOW, SJOO, SJOOW, SJT, SJTW, SJTO, SJTOW, SJTOO, SJTOOW	15/125

Special-use cord sets

Cat. No.	IEC 320 Cord Config AWG	Cord Type	Electrical Rating Amps V	
YC-11	IEC C17	18	SPT-1, SPT-2, SPT-3, NISPT-2, SVT, SJT, SJTO, SJTOW, ST, STW, STOW (All TPE material), SPT-1, SPT-2, NISPT-1, NISPT-2, SPT-3, SVT, SJT, SJTO, SJTW, SJTOW, ST, STW, STOW, SO, SOW, SOOW	2.5, 7 or 10/125 or 250
		17	SPT-3, SVT, SJT, SJTW, SJTO, SJTOW, ST, STW, STOW (All TPE material), SPT-3, SVT, SJT, SJTW, SJTO, SJTOW, ST, STW, STOW, SO, SOW, SOOW	10, 12/125 or 250
		16	SPT-2, SPT-3, NISPT-2, SVT, SJT, SJTW, SJTO, SJTOW, ST, STW, STOW (All TPE material), SPT-2, NISPT-2, SPT-3, SVT, SJT, SJTW, SJTO, SJTOW, ST, STW, STOW, SO, SOW, SOOW	13/125 or 250
YC-12, YC-12L, YC-12L-1, YC-12L-2, YC-12L-3	IEC C13	18	SVT, SJT, SJTW, SJTO, SJTOW, ST, STW, STOW (Shielded and Non-shielded for all types), SPT-2, SPT-3 (All TPE material), SVT, SJT, SJTW, SJTO, SJTOW, SJ, SJO, SJOO, SJOW, SJOOW, ST, STW, STOW, SO, SOO, SOW, SOOW (Shielded or Non-Shielded for above types), SPT-2, SPT-3	2.5, 7 or 10/125 or 250
		17	SVT, SJT, SJTW, SJTO, SJTOW, ST, STW, STOW (Shielded and Non-shielded for all types), SPT-3 (All TPE material), SVT, SJT, SJTW, SJTO, SJTOW, ST, STW, STOW, SJ, SJO, SJOO, SJOW, SJOOW, SO, SOO, SOW, SOOW (Shielded or Non-shielded for above types), SPT-3	10, 12/125 or 250
		16	SJT, SJTW, SJTO, SJTOW, ST, STW, STOW (Shielded and Non-shielded for all types), SPT-3 (All TPE material), SJT, SJTW, SJTO, SJTOW, ST, STW, STOW, SJ, SJO, SJOO, SJOW, SJOOW, SO, SOO, SOW, SOOW (Shielded or Non-shielded for above types), SPT-2, SPT-3	13/125 or 250
		15	SJT, SJTW, SJTO, SJTOW, ST, STW, STOW (Shielded and Non-shielded for all types), SPT-3 (All TPE material), SJT, SJTW, SJTO, SJTOW, ST, STW, STOW, SJ, SJO, SJOO, SJOW, SJOOW, SO, SOO, SOW, SOOW (Shielded or Non-shielded for above types), SPT-3	10, 14/125 or 250

		14	SJT, SJTW, SJTO, SJTOW, ST, STW, STOW (Shielded and Non-shielded for all types), SPT-3 (All TPE material), SJT, SJTW, SJTO, SJTOW, ST, STW, STOW, SJ, SJO, SJOO, SJOW, SJOOOW, SO, SOO, SOW, SOOW (Shielded or Non-shielded for above types), SPT-3	15/125 or 250
		12	SJT, SJTW, SJTO, SJTOW, ST, STW, STOW (All TPE material, Shielded and Non-shielded for all types), SJT, SJTW, SJTO, SJTOW, ST, STW, STOW, SJ, SJO, SJOO, SJOW, SJOOOW, SO, SOO, SOW, SOOW (Shielded or Non-shielded for all types)	15/125 or 250
YC-12(A.C.1)	IEC C13	12	SJT, SJTW, SJTO, SJTOW, ST, STW, STOW, SPT-3 (All TPE material), SJT, SJTW, SJTO, SJTOW, ST, STW, STOW, SO, SOW, SOOW, SPT-3	15/125 or 250
		10	SJT, SJTW, SJTO, SJTOW, ST, STW, STOW (All TPE material), SJT, SJTW, SJTO, SJTOW, ST, STW, STOW, SO, SOW, SOOW	15/125 or 250
YC-12C	IEC C13	18	NISPT-2 (TPE), NISPT-2	2.5, 7 or 10/125 or 250
		16	NISPT-2 (TPE), NISPT-2	13/125 or 250
YC-13	IEC C7	18	SPT-1, SPT-2, NISPT-2, SVT, SJT (All TPE material), SPT-1, SPT-1W, SPT-2, SPT-2W, NISPT-1, NISPT-2, SVT, SJT	2.5/250 or 7/125
YC-13W	IEC C7P	18	SPT-1, SPT-2, NISPT-2, SVT, SJT (All TPE material), SPT-1, SPT-1W, SPT-2, SPT-2W, NISPT-1, NISPT-2, SVT, SJT	2.5/250 or 7/125
YC-14	IEC C5	18	SPT-2, SVT, SVT shielded, SVTO, SJT, SJT shielded, SJTW, SJTW shielded, SJTO, SJTOW (All TPE material), SVT, SVT Shielded, SVTO, SJT, SJT Shielded, SJTW, SJTW Shielded, SJTO, SJTOW, SV, SVO, SJ, SJO, SJOW, SJOOOW	2.5/250 or 7/125
			SPT-2	
YC-13L	IEC C7	18	SPT-1, SPT-2, NISPT-2, SVT, SJT (All TPE material), SPT-1, SPT-1W, SPT-2, SPT-2W, NISPT-1, NISPT-2, SVT, SJT	2.5/250 or 7/125
YC-13D	IEC C7	18	SPT-1, SPT-2, NISPT-2, SVT, SJT (All TPE material), SPT-1, SPT-1W, SPT-2, SPT-2W, NISPT-1, NISPT-2, SJT, SVT	2.5/250 or 7/125
YC-13C	IEC C7	18	NISPT-2 (All TPE material), NISPT-1, NISPT-2	2.5/250 or 7/125
YC-13E	IEC C7	18	SPT-1, SPT-2, NISPT-2, SVT, SJT (All TPE material), SPT-1, SPT-1W, SPT-2, SPT-2W, NISPT-1, NISPT-2, SVT, SJT	2.5/250 or 7/125
YC-14L, YC-14L-1, YC-14L-2, YC-14L-3	IEC C5	18	SVT, SJT, SPT-2 (All TPE material), SVT, SJT, SPT-2	2.5/250 or 7/125
YC-18	IEC C19	16	SJT, SJTW, SJTO, SJTOW, SJTOOW, ST, STW, STOW, STOOW, SPT-3 (All TPE material), SJT, SJTW, SJTO, SJTOW, SJTOOW, SJ, SJO, SJOO, SJOW, SJOOOW, ST, STW, STOW, STOOW, S, SO, SOW, SOO, SOOW, SPT-3	13/125 or 250



Certificate of Compliance

Certificate: 70206738

Master Contract: 177323 (076393)

Project: 70206738

Date Issued: 2019-03-19

Issued to: Yung Li Company Ltd.
7F-12, NO.99, Sec.1
Xintai 5th Rd., Xizhi Dist
New Taipei City, 22175
TAIWAN
Attention: W.T. Lai

The products listed below are eligible to bear the CSA Mark shown



Issued by: Wenwen (Vivian) Zhao
Wenwen (Vivian) Zhao

PRODUCTS

CLASS - C584202 - CORD SETS-Power Supply Cords

Power supply cord(s) consisting of the following plug connector or cord connector moulded onto flexible cords as listed:

Power Supply Cord		Flexible Cord		
Cat No	Configuration	AWG	Rating	Type
YC-12, YC-12L	Connector 60320 C13	18/3	10 A, 125/250 V	SPT-2, SPT-3, SVT(S&U), SJT(S&U), SJTW(S&U), SJTO(S&U), SJTOW(S&U), SJ(S&U), SJO(S&U), SJO(S&U), SJOW(S&U), SJOOW(S&U), ST(S&U), STW(S&U), STOW(S&U)d, SO(S&U), SOO(S&U), SOW(S&U), SOOW(S&U)
		16/3	13 A, 125/250 V	SPT-3, SJT(S&U), SJTW(S&U), SJTO(S&U), SJTOW(S&U), SJ(S&U), SJO(S&U), SJO(S&U), SJOW(S&U), SJOOW(S&U), ST(S&U), STW(S&U), STOW(S&U)d, SO(S&U), SOO(S&U), SOW(S&U), SOOW(S&U)



Certificate: 70206738

Master Contract: 177323

Project: 70206738

Date Issued: 2019-03-19

		14/3	15 A, 125/250 V	SPT-3, SJT(S&U), SJTW(S&U), SJTO(S&U), SJTOW(S&U), SJ(S&U), SJO(S&U), SJO(S&U), SJOW(S&U), SJOOW(S&U), ST(S&U), STW(S&U), STOW(S&U), SO(S&U), SOO(S&U), SOW(S&U), SOOW(S&U)
YC-13, YC-13L, YC-13W	Connector 60320 C7	18/2	2.5 A 250V or 7A 125 V	SPT-1, NISPT-1, SPT-2, NISPT-2, SPT-1W, SPT-2W, SVT, SJT
YC-14	Connector 60320 C5	18/3	2.5 A 250V or 7A 125 V	SPT-2, SVT (S&U), SVTO, SJT(S&U), SJTW(S&U), SJTO, SJTOW, SV, SVO, SJ, SJO, SJOW, SJOOW
YP-32, YP-32L	Connector 60320 C14	18	10 A, 125V/250 V	SVT (S&U), SJT(S&U) , SJTW (S&U), SJTO(S&U), SJTOW(S&U), ST(S&U), STW(S&U), STOW(S&U), SJ (S&U), SJO(S&U), SJO(S&U), SJOOW(S&U), SO(S&U), SOO(S&U), SOW(S&U), SOOW(S&U)
		16	13A, 125V/250 V	SJT(S&U) , SJTW (S&U), SJTO(S&U), SJTOW(S&U), ST(S&U), STW(S&U), STOW(S&U), SJ (S&U), SJO(S&U), SJO(S&U), SJOOW(S&U), SO(S&U), SOO(S&U), SOW(S&U), SOOW(S&U)
		14	15A, 125V/250 V	SJT(S&U) , SJTW (S&U), SJTO(S&U), SJTOW(S&U), SJ (S&U), SJO(S&U), SJO(S&U), SJOOW(S&U), SO(S&U), SOO(S&U), SOW(S&U), SOOW(S&U)

Legend: (Sp) - Special-use; (S&U) – Shielded and Unshielded.

Conditions of Acceptability:

These power supply cords are sold only to manufacturers as components for assembly into Certified electrical equipment, where the suitability of the combination is determined by CSA International.

APPLICABLE REQUIREMENTS

- CSA Standard C22.2 No. 21-14 - Cord Sets and Power Supply Cords
- CSA-C22.2 No. 60320-1-1 - Appliance Couplers For Household And Similar General Purposes
- Part 1: General Requirements

**ZJCZ.E241374**
Flexible Cord[Page Bottom](#)**Flexible Cord**[See General Information for Flexible Cord](#)**YUNG LI CO LTD**

E241374

7F-12 NO 99 SEC 1 XINTAI 5TH RD
XIZHI DISTRICT
NEW TAIPEI, 22175 TAIWAN

Decorative cord, Type(s) SPT-1W, SPT-2W**Dryer and range cord**, Type(s) SRDT**Jacketed cord**, Type(s) S, SE, SE-HF, SJ, SJE, SJE-HF, SJO, SJO, SJOOW, SJOW, SJJ, SJJ-B, SJTO, SJTOW, SJTW, SO, SOO, SOOW, SOW, ST, ST-B, STO, STOW, STW, SVE, SVE-HF, SVT, SVT-B, SVTO**Parallel cord**, Type(s) NISPE-1, NISPE-1-HF, NISPE-2, NISPE-2-HF, NISPT-1, NISPT-2, SPE-1, SPE-1-HF, SPE-2, SPE-2-HF, SPE-3, SPE-3-HF, SPT-1, SPT-2, SPT-3[Last Updated](#) on 2016-03-07[Questions?](#)[Print this page](#)[Terms of Use](#)[Page Top](#)

◆ 2016 UL LLC

The appearance of a company's name or product in this database does not in itself assure that products so identified have been manufactured under UL's Follow-Up Service. Only those products bearing the UL Mark should be considered to be Certified and covered under UL's Follow-Up Service. Always look for the Mark on the product.

UL permits the reproduction of the material contained in the Online Certification Directory subject to the following conditions: 1. The Guide Information, Assemblies, Constructions, Designs, Systems, and/or Certifications (files) must be presented in their entirety and in a non-misleading manner, without any manipulation of the data (or drawings). 2. The statement "Reprinted from the Online Certifications Directory with permission from UL" must appear adjacent to the extracted material. In addition, the reprinted material must include a copyright notice in the following format: "© 2016 UL LLC".



Certificate of Compliance

Certificate: 1594794 (LL 76398)

Master Contract: 177323

Project: 2616524

Date Issued: April 3, 2013

Issued to: Yung Li Company Ltd.

1F No 10 Lane 235 Pao Chiao Rd
Hsin Tien City
Taipei Hsien,
Taiwan
Attention: Wendy Wu

The products listed below are eligible to bear the CSA Mark shown



Kim Nguyen

Issued by: Kim Nguyen, P. Eng.

PRODUCTS

CLASS 5831 01 - WIRES - Flexible Cord

Types SPT-1, NISPT-1, SPT-2, NISPT-2, SPT-3, SVT, SVTO, SJT, SJTW, SJTO, SJTOW, ST, STW, STO, STOW with PVC insulation and jacket, rated 60C, 75C, 90C and 105C, FT1, FT2, VW-1.

APPLICABLE REQUIREMENTS

CSA C22.2 No 49 - Flexible Cords and Cables