

# 東莞永力電業有限公司

YUNG LI CO., LTD

Da Pu Industrial Zone, Gang Zi, Changping Town,  
Dong Guan City, Guangdong 523571 China.P.R.C

TEL:0769-83396797~8

FAX:0769-83396796

E-mail: sales@yung-li.com

Description: YP-32/YC-18

Customer: SIGNAL+POWER

Parts No. : P-3218-03B-14

Draw No. :

## REVISION RECORD

1		
2		
3		
4		
5		

YUNG LI	
CHECKED	PREPARED BY

CUSTOMER	APPROVED

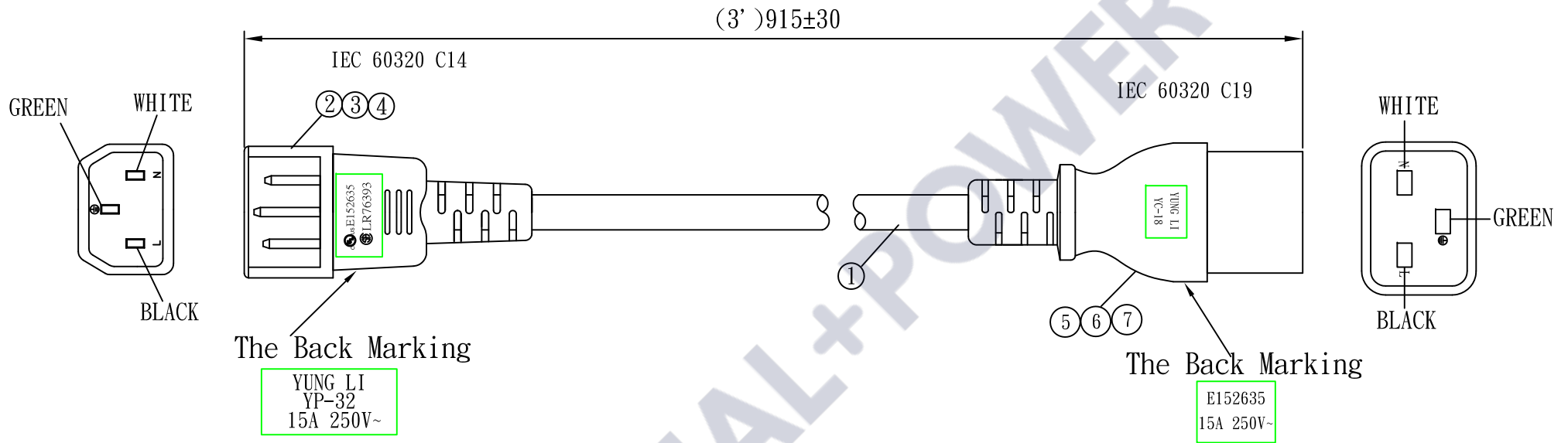

Packing: Bulk Pack

NO.	SPECIFICATION	QTY	REMARK
1	SJT 14/3C 105 °C BLACK	1PC	
2	YP-32 PVC PLASTIC:35P BLACK	15g/PC	
3	TER:98672BS-1	3PCS	
4	INNER BODY: 2X4	1PC	
5	YC-18 PVC PLASTIC:50P BLACK	25g/PC	
6	YC-18 INNER BODY	1PC	
7	YC-18 TER	3PCS	

Tolerance >0±0.30 >1.0±0.50 >10.0±1.0 >20.0±2.0 Angle: ±1°	Approved		Date		<b>SIGNAL+POWER</b>			
	Checked		Date					
	Drawn		Date		Customer			
	Cat. No.	YP-32/YC-18			P/N.	P-3218-03B-14		
	Drawing No.	CY-U5015		Rev.	D	Material	P. V. C	Unit
					Scale			

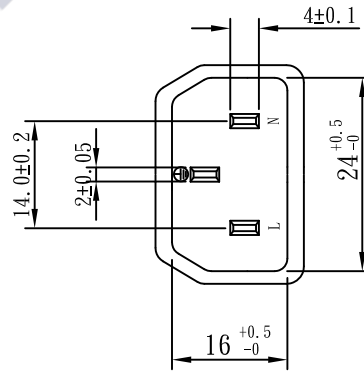
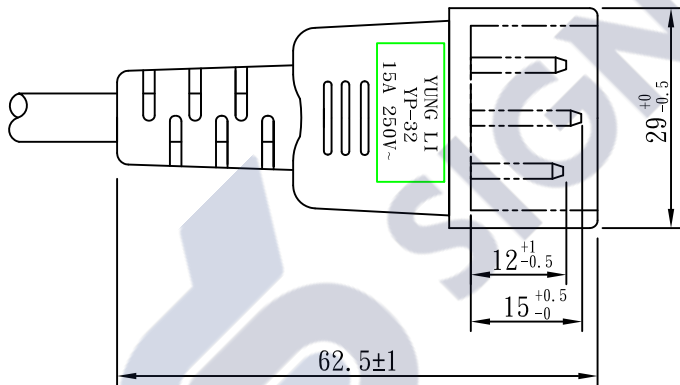
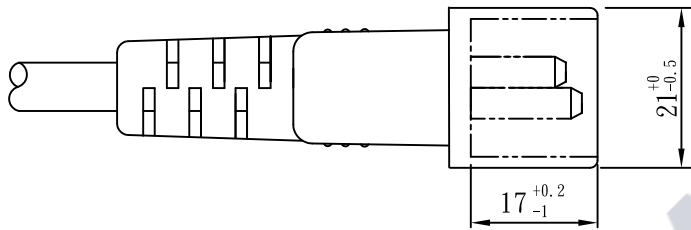
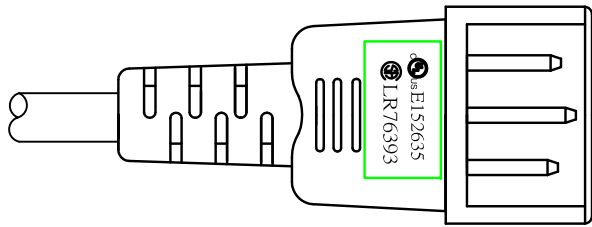

TOLERANCE >0±0.30 >1.0±0.50 >10.0±1.0 >20.0±2.0 Angle: ±1°	APPROVED		DATE		YUNG LI CO., LTD			
	CHECKED		DATE					
	DRAWN		DATE		CUSTOMER			
	TYPE	YP-32			P/N			
	DRAWING NO.	CY-P32U15A	REV	B	MATERIAL	P. V. C	UNIT	mm
				SCALE	1:1			

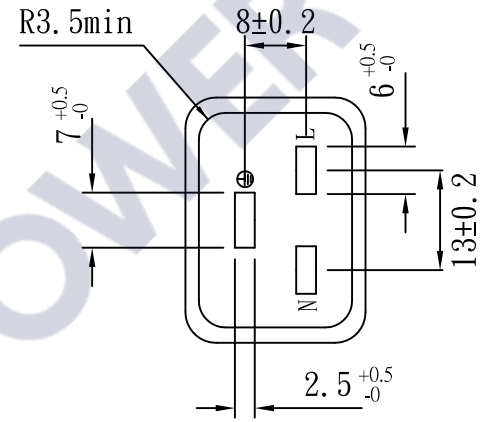
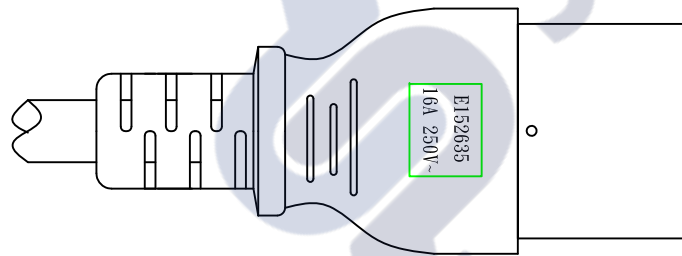
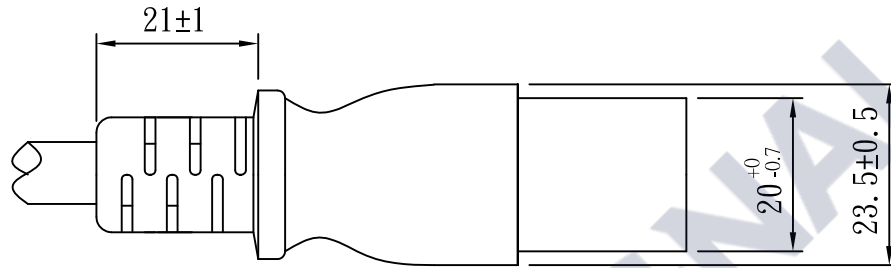
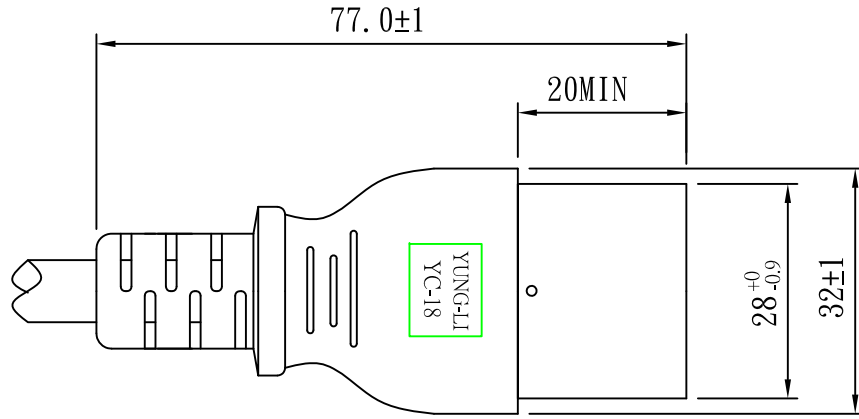

TOLERANCE >0±0.30 >1.0±0.50 >10.0±1.0 >20.0±2.0 Angle: ±1°	APPROVED		DATE		YUNG LI CO., LTD			
	CHECKED		DATE					
	DRAWN		DATE		CUSTOMER			
	TYPE	YC-18			P/N			
	DRAWING NO.	CY-C18U	REV	B	MATERIAL	P. V. C	UNIT	mm
				SCALE	1:1			

# YUNG LI CO., LTD

## SPECIFICATION

Yung-Li	Style	PVC FLEXIBLE CORDS	Document No
2007.8.02			
Edition	Size	<b>SJT 14/ 3C 105</b>	Page
A			1/2

1. Standard : UL 62 UL 1581

### 2. Construction & Dimension

	Item	Specification
Conductor	Size	14AWG X 3C
	Material	Annealed Bare Copper
	Construction	41/ 0.254±0.003
Insulation	Material	PVC
	Minimum Average Thickness	0.76mm
	Minimum Thickness at any point	0.69mm
	Diameter	3.5 ± 0.10
	Identification	Black White Green
Core Assembly	Core Twist	3-Core
	Filler	Cotton 15000D
	Assembly Pair	NA
Taping	Mylar Foil	NA
Shielded	A1-Mylar Foil	NA
Drain Wire	Material	NA
	Construction	NA
Jacket	Material	PVC
	Minimum Average Thickness	0.76mm
	Minimum Thickness at any point	0.61mm
	Overall Diameter(Approx)	9.3± 0.15
	Color	Any Color

### Marking :

YUNG LI (UL) E241374 SJT 3/C 14AWG(2.08mm<sup>2</sup>) 105 300V VW-1  
 CSA 177323 SJT 3/C 14AWG(2.08mm<sup>2</sup>) 105 300V FT2

# YUNG LI CO., LTD

## SPECIFICATION

Yung-Li	Style	PVC FLEXIBLE CORDS	Document No
2007.8.02			
Edition	Size	<b>SJT 14/ 3C 105</b>	Page
A			2/2

3. Electrical & Physical Properties			
Item		Specification	
Rating Voltage		300V	
Insulation Resistance		0.76MΩ/Km 15.0 Min	
Dielectric Strength		AC 2.0KV/1 min No Crack	
Spark Test		6.0KV/0.15 Sec	
Insulation	Unaged	Tensile Strength	1500 lbs/in <sup>2</sup> min
		Elongation	100% Min
	Aged	Tensile Strength	Min 85%(136±1 x168hrs)
		Elongation	Min 65%(136±1 x168hrs)
Jacket	Unaged	Tensile Strength	1500 lbs/in <sup>2</sup> min
		Elongation	100% Min
	Aged	Tensile Strength	Min 85%(136±1 x168hrs)
		Elongation	Min 45%(136±1 x168hrs)
Deformation Test		121±1 m X 1hr 50%	
Cold Bend Test		-20 x 4hr No Crack	
Heat Shock Test		121±1 x 1hr No Crack	

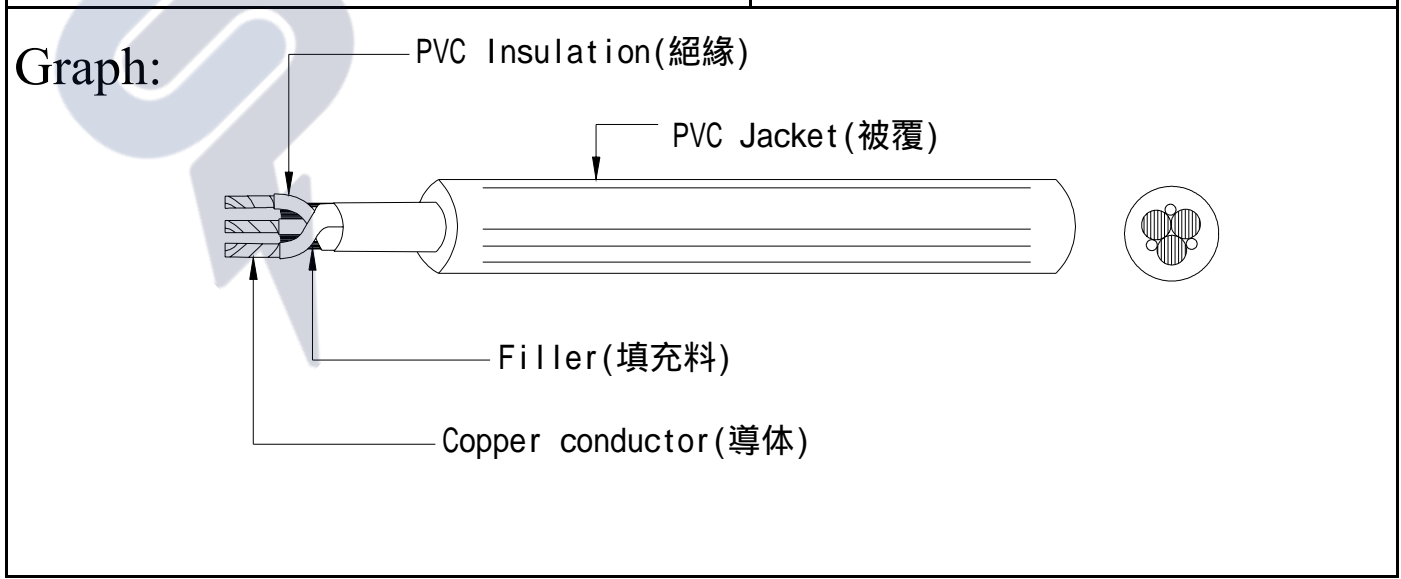



## ELBZ7.E152635

## Cord Sets and Power-supply Cords Certified for Canada

Page Bottom

## Cord Sets and Power-supply Cords Certified for Canada

[See General Information for Cord Sets and Power-supply Cords Certified for Canada](#)

## YUNG LI CO LTD

E152635

1ST FL

10 LANE 235 PAO-CHIAO RD

HSIN-TIEN, TAIPEI HSIEN 231 TAIWAN

## Power-supply cords

Cat. No.	ANSI /NEMA WD6 Config	Cord AWG	Cord Type	Electrical Rating Amps V
YP-11	1-15	18/2	SPT-1, SPT-1W, NISPT-1, SPT-2, SPT-2W, NISPT-2, SPT-3, HPN, SVT, SVTO, SJT, SJTW, SJTO, SJTOW, SV, SVO, SJ, SJO, SJOW, SJOOW	10/125
		17/2	SVT, SVTO, SV, SVO, SJ, SJO, SJOW, SJOOW	12/125
		16/2	SPT-2, SPT-2W, NISPT-2, SPT-3, SVT, SVTO, SJT, SJTW, SJTO, SJTOW, SV, SVO, SJ, SJO, SJOW, SJOOW	13/125
		16/2	HPN	15/125
		14/2	SPT-3, SJT, SJTW, SJTO, SJTOW, SJ, SJO, SJOW, SJOOW	15/125
YP-11W	1-15P	18/2	SPT-1, SPT-1W, NISPT-1, SPT-2, SPT-2W, NISPT-2, SPT-3, HPN, SVT, SVTO, SJT, SJTW, , SJTO, SJTOW, SV, SVO, SJ, SJO, SJOW, SJOOW	10/125
		17/2	SVT, SVTO, SV, SVO, SJ, SJO, SJOW, SJOOW	12/125
		16/2	SPT-2, SPT-2W, NISPT-2, SPT-3, SVT, SVTO, SJT, SJTW, SJTO, SJTOW, SV, SVO, SJ, SJO, SJOW, SJOOW	13/125
		16/2	HPN	15/125
		14/2	SPT-3, SJT, SJTW, SJTO, SJTOW, SJ, SJO, SJOW, SJOOW	15/125
YP-11C	1-15	18/2	NISPT-1, NISPT-2	10/125
YP-12	5-15	18/3	SVT, SVT Shielded, SVTO, SJT, SJT Shielded, SJTW, SJTW Shielded, SJTO, SJTO Shielded, SJTOW, SJTOW Shielded, ST, ST Shielded, STW, STW Shielded, STOW, STOW Shielded, SV, SVO, SJ, SJ Shielded, SJO, SJO Shielded, SJOOW, SJOOW Shielded, SJOW, SJOW Shielded, SJOOW, SJOOW Shielded, S, SO, SO Shielded, SOO, SOO Shielded, SOW, SOW Shielded, SOOW, SOOW Shielded, SPT-2, SPT-3	10/125
		17/3	SVT, SVTO, SV, SVO	12/125
		16/3	SVT, SVT Shielded, SVTO, SJT, SJT Shielded, SJTW, SJTW Shielded, SJTO, SJTO Shielded, SJTOW, SJTOW Shielded, ST, ST Shielded, STW, STW Shielded, STOW, STOW Shielded, SV, SVO, SJ, SJ Shielded, SJO, SJO Shielded, SJOOW, SJOOW Shielded, SJOW, SJOW Shielded, SJOOW, SJOOW Shielded, S,	13/125

		16/3	SJT, SJTW	13/125
YL-921B	1-15	18/2	SPT-1, SPT-2, NISPT-1, NISPT-2, SVT, SJT, SJTW, SJTO, SJTOW, SJ, SJO, SJOW, SJOOW	10/125
		16/2	SPT-2, NISPT-2, SVT, SJT, SJTW, SJTO, SJTOW, SJ, SJO, SJOW, SJOOW	13/125
YP-19L	6-15	18/3	SJT, SJTW, SJTO, SJTOW, ST, STW, STOW, SO, SOW, SOOW	10/250
		16/3	SJT, SJTW, SJTO, SJTOW, ST, STW, STOW, SO, SOW, SOOW	13/250
		14/3	SJT, SJTW, SJTO, SJTOW, ST, STW, STOW, SO, SOW, SOOW, SPT-3	15/250
		12/3	SJT, SJTW, SJTO, SJTOW, ST, STW, STOW, SO, SOW, SOOW, SPT-3	15/250
YP-31	IEC C8	18/2	SVT, SVTO, SJT, SJTW, SJTO, SJTOW, SV, SVO, SJ, SJO, SJOW, SJOOW, SPT-1, SPT-1W, SPT-2, SPT-2W, NISPT-1, NISPT-2	10/125 or 250
YP-32, YP-32L	IEC C14	18/3	SVT, SVT Shielded, SJT, SJTW, SJT Shielded, SJTW Shielded, SJTO, SJTO Shielded, SJTOW, SJTOW Shielded, ST, ST Shielded, STW, STW Shielded, STOW, STOW Shielded, SJ, SJ Shielded, SJO, SJO Shielded, SJOO, SJOO Shielded, SJOW, SJOW Shielded, SJOOW, SJOOW Shielded, SO, SO Shielded, SOO, SOO Shielded, SOW, SOW Shielded, SOOW, SOOW Shielded	10/250
		16/3	SJT, SJT Shielded, SJTW, SJTW Shielded, SJTO, SJTO Shielded, SJTOW, SJTOW Shielded, ST, ST Shielded, STW, STW Shielded, STOW, STOW Shielded, SJ, SJ Shielded, SJO, SJO Shielded, SJOO, SJOO Shielded, SJOW, SJOW Shielded, SJOOW, SJOOW Shielded, SO, SO Shielded, SOO, SOO Shielded, SOW, SOW Shielded, SOOW, SOOW Shielded	13/250
		14/3	SJT, SJT Shielded, SJTW, SJTW Shielded, SJTO, SJTO Shielded, SJTOW, SJTOW Shielded, ST, ST Shielded, STW, STW Shielded, STOW, STOW Shielded, SJ, SJ Shielded, SJO, SJO Shielded, SJOO, SJOO Shielded, SJOW, SJOW Shielded, SJOOW, SJOOW Shielded, SO, SO Shielded, SOO, SOO Shielded, SOW, SOW Shielded, SOOW, SOOW Shielded	15/250
YP-12D	5-15	18/3	SVT, SJT, SJT Shielded, SJTW, SJTO, SJTOW	10/125
		16/3	SVT, SJT, SJT Shielded, SJTW, SJTO, SJTOW	13/125
		14/3	SVT, SJT, SJT Shielded, SJTW, SJTO, SJTOW	15/125
YP-32A	IEC C14	18/3	SVT, SJT, SJT Shielded, SJTW, SJTO, SJTOW	10/250
		16/3	SVT, SJT, SJT Shielded, SJTW, SJTO, SJTOW	13/250
		14/3	SVT, SJT, SJT Shielded, SJTW, SJTO, SJTOW	15/250
YP-33	IEC C20	18/3	SJT, SJT shielded, SJTW, SJTW shielded, SJTO, SJTO shielded, SJTOO, SJTOO shielded, SJTOW, SJTOW shielded, SJTOOW, SJTOOW shielded, SJ, SJ shielded, SJO, SJO shielded, SJOO, SJOO shielded, SJOW, SJOW shielded, SJOOW, SJOOW shielded, ST, ST shielded, STW, STW shielded, STOW, STOW shielded, STOOW, STOOW shielded, S, SO, SO shielded, SOW, SOW shielded, SOO, SOO shielded, SOOW, SOOW shielded	10/250
		16/3	SJT, SJT shielded, SJTW, SJTW shielded, SJTO, SJTO shielded, SJTOO, SJTOO shielded, SJTOW, SJTOW shielded, SJTOOW, SJTOOW shielded, SJ, SJ shielded, SJO, SJO shielded, SJOO, SJOO shielded, SJOW, SJOW shielded, SJOOW, SJOOW shielded, ST, ST shielded, STW, STW shielded, STOW, STOW	13/250



YC-12, YC-12L, YC-12L-1, YC-12L-2, YC-12L-3	IEC C13	18	SVT, SVT Shielded, SJT, SJT Shielded, SJTW, SJTW Shielded, SJTO, SJTO Shielded, SJTOW, SJTOW Shielded, SJ, SJ Shielded, SJO, SJO Shielded, SJOO, SJOO Shielded, SJOW, SJOW Shielded, SJOOW, SJOOW Shielded, ST, ST Shielded, STW, STW Shielded, STOW, STOW Shielded, SO, SO Shielded, SOO, SOO Shielded, SOW, SOW Shielded, SOOW, SOOW Shielded, SPT-2, SPT-3	10/125 or 250
		16	SJT, SJT Shielded, SJTW, SJTW Shielded, SJTO, SJTO Shielded, SJTOW, SJTOW Shielded, ST, ST Shielded, STW, STW Shielded, STOW, STOW Shielded, SJ, SJ Shielded, SJO, SJO Shielded, SJOO, SJOO Shielded, SJOW, SJOW Shielded, SJOOW, SJOOW Shielded, SO, SO Shielded, SOO, SOO Shielded, SOW, SOW Shielded, SOOW, SOOW Shielded, SPT-3	13/125 or 250
		14	SJT, SJT Shielded, SJTW, SJTW Shielded, SJTO, SJTO Shielded, SJTOW, SJTOW Shielded, ST, ST Shielded, STW, STW Shielded, STOW, STOW Shielded, SJ, SJ Shielded, SJO, SJO Shielded, SJOO, SJOO Shielded, SJOW, SJOW Shielded, SJOOW, SJOOW Shielded, SO, SO Shielded, SOO, SOO Shielded, SOW, SOW Shielded, SOOW, SOOW Shielded, SPT-3	15/125 or 250
		12	SJT, SJT Shielded, SJTW, SJTW Shielded, SJTO, SJTO Shielded, SJTOW, SJTOW Shielded, ST, ST Shielded, STW, STW Shielded, STOW, STOW Shielded, SJ, SJ Shielded, SJO, SJO Shielded, SJOO, SJOO Shielded, SJOW, SJOW Shielded, SJOOW, SJOOW Shielded, SO, SO Shielded, SOO, SOO Shielded, SOW, SOW Shielded, SOOW, SOOW Shielded	15/125 or 250
YC-12 (A.C.1)	IEC C13	12	SJT, SJTW, SJTO, SJTOW, ST, STW, STOW, SO, SOW, SOOW, SPT-3	125/250
		10	SJT, SJTW, SJTO, SJTOW, ST, STW, STOW, SO, SOW, SOOW	125/250
YC-12C	IEC C13	18	NISPT-2	125/250
		16	NISPT-2	125/250
YC-13	IEC C7	18	SPT-1, SPT-1W, SPT-2, SPT-2W, NISPT-2, SVT, SJT NISPT-1	125
YC-13W	IEC C7P	18	SPT-1, SPT-1W, SPT-2, SPT-2W, NISPT-2	125
YC-14	IEC C5	18	SVT, SVT Shielded, SVTO, SJT, SJT Shielded, SJTW, SJTW Shielded, SJTO, SJTOW, SV, SVO, SJ, SJO, SJOW, SJOOW SPT-2	10/125 or 250
YC-13L	IEC C7	18	SPT-1, SPT-1W, SPT-2, SPT-2W	125
YC-13D	IEC C7	18	SPT-1, SPT-1W, SPT-2, SPT-2W, NISPT-1, NISPT-2, SJT, SVT	125
YC-13C	IEC C7	18	NISPT-1, NISPT-2	125
YC-14L, YC-14L-1, YC-14L-2, YC-14L-3	IEC C5	18	SVT, SJT, SPT-2	15
YC-18	IEC C19	16	SJT, SJTW, SJTO, SJTOW, SJTOOW, SJ, SJO, SJOO, SJOW, SJOOW, ST, STW, STOW, STOOW, S, SO, SOW, SOO, SOOW, SPT-3	125 or 250
		14	SJT, SJTW, SJTO, SJTOW, SJTOOW, SJ, SJO, SJOO, SJOW, SJOOW, ST, STW, STOW, STOOW, S, SO, SOW, SOO, SOOW, SPT-3	125 or 250
		12	SJT, SJTW, SJTO, SJTOW, SJTOOW, SJ, SJO, SJOO, SJOW, SJOOW, ST, STW, STOW, STOOW, S, SO, SOW, SOO, SOOW, SPT-3	125 or 250 V ac
YC-18L	IEC C19	16	SJT, SJTW, SJTO, SJTOW, SJTOOW, SJ, SJO, SJOO, SJOW, SJOOW, ST, STW, STOW, STOOW, S, SO, SOW, SOO, SOOW, SPT-3	125 or 250 V ac
		14	SJT, SJTW, SJTO, SJTOW, SJTOOW, SJ, SJO, SJOO, SJOW, SJOOW, ST, STW, STOW, STOOW, S, SO, SOW, SOO, SOOW,	125 or 250 V ac

**ZJCZ.E241374**  
**Flexible Cord**[Page Bottom](#)

---

**Flexible Cord**[See General Information for Flexible Cord](#)**YUNG LI CO LTD**

E241374

1ST FL

10 LANE 235 PAO-CHIAO RD

HSIN-TIEN, TAIPEI HSIEN 231 TAIWAN

**Jacketed cords**, Type SJTW, STW, SJTO, SJTOW, STO, STOW, SJ, S, SJO, SO, SVT, SVTO, SJT, ST, SJOW, SJOOW, SOW, SOOW, SJOO, SOO.

**Parallel cords**, Type SPT-1, SPT-2, SPT-3, SPT-1W, SPT-2W, NISPT-1, NISPT-2.

**Rang and dryer cord**, Type SRDT.

[Last Updated on 2007-02-12](#)

---

[Questions?](#)[Notice of Disclaimer](#)[Page Top](#)[Copyright © 2007 Underwriters Laboratories Inc.®](#)

The appearance of a company's name or product in this database does not in itself assure that products so identified have been manufactured under UL's Follow-Up Service. Only those products bearing the UL Mark should be considered to be Listed and covered under UL's Follow-Up Service. Always look for the Mark on the product.

UL permits the reproduction of the material contained in the Online Certification Directory subject to the following conditions: 1. The Guide Information, Designs and/or Listings (files) must be presented in their entirety and in a non-misleading manner, without any manipulation of the data (or drawings). 2. The statement "Reprinted from the Online Certifications Directory with permission from Underwriters Laboratories Inc." must appear adjacent to the extracted material. In addition, the reprinted material must include a copyright notice in the following format: "Copyright © 2007 Underwriters Laboratories Inc.®"

An independent organization working for a safer world with integrity, precision and knowledge.



# Certificate of Compliance

**Certificate:** 1594794 (LL 76398)

**Master Contract:** 177323

**Project:** 2128031

**Date Issued:** 2009/03/03

**Issued to:** Yung Li Company Ltd.  
1F No 10 Lane 235 Pao Chiao Rd  
Hsin Tien City  
Taipei Hsien,  
Taiwan  
**Attention:** Mr. W.T. Lai

*The products listed below are eligible to bear the CSA Mark shown*



**Issued by:** Kim Nguyen, P. Eng.

**Authorized by:** Nick Alfano, Operations  
Manager

## PRODUCTS

**CLASS 5831 01** - WIRES - Flexible Cord

Types SPT-1, NISPT-1, SPT-2, NISPT-2, SPT-3, SVT, SVTO, SJT, SJTW, SJTO, SJTOW, ST, STW, STO, STOW with PVC insulation and jacket, rated 60C, 75C, 90C and 105C, FT1, FT2, VW-1.

## APPLICABLE REQUIREMENTS

CSA C22.2 No 49 - Flexible Cords and Cables



## Supplement to Certificate of Compliance

Certificate: 1594794

Master Contract: 177323

*The products listed, including the latest revision described below, are eligible to be marked in accordance with the referenced Certificate.*

### Product Certification History

---

Project	Date	Description
2128031	2009/03/03	Adding temperature ratings of 75C and 90C to Types SPT-1,-2,-3, NISPT-1,-2, SVT, SJT, SJTW, ST and STW.
1929621	2007/10/17	Types SJTO, SJTOW, STO, STOW, SVTO added.
1625068	2005/01/10	Addition of Flexible cords Types SJTW, STW rated 60C, 105C
1594794	2004/10/14	Original Certification: Flexible Cords SPT-1, -2, -3, NISPT-1, -2, SVT, SJT, ST