

東莞永力電業有限公司

YUNG LI CO., LTD

Da Pu Industrial Zone, Gang Zi, Changping Town,
Dong Guan City, Guangdong 523571 China.P.R.C

TEL:0769-83396797~8

FAX:0769-83396796

E-mail: sales@yung-li.com

Description: YP-32/YC-12

Customer: SIGNAL+POWER

Parts No. : P-3212-XXYYY-14

Draw No. :

REVISION RECORD

1		
2		
3		
4		
5		

YUNG LI	
CHECKED	PREPARED BY

CUSTOMER	APPROVED

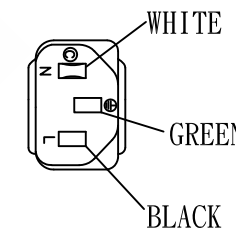
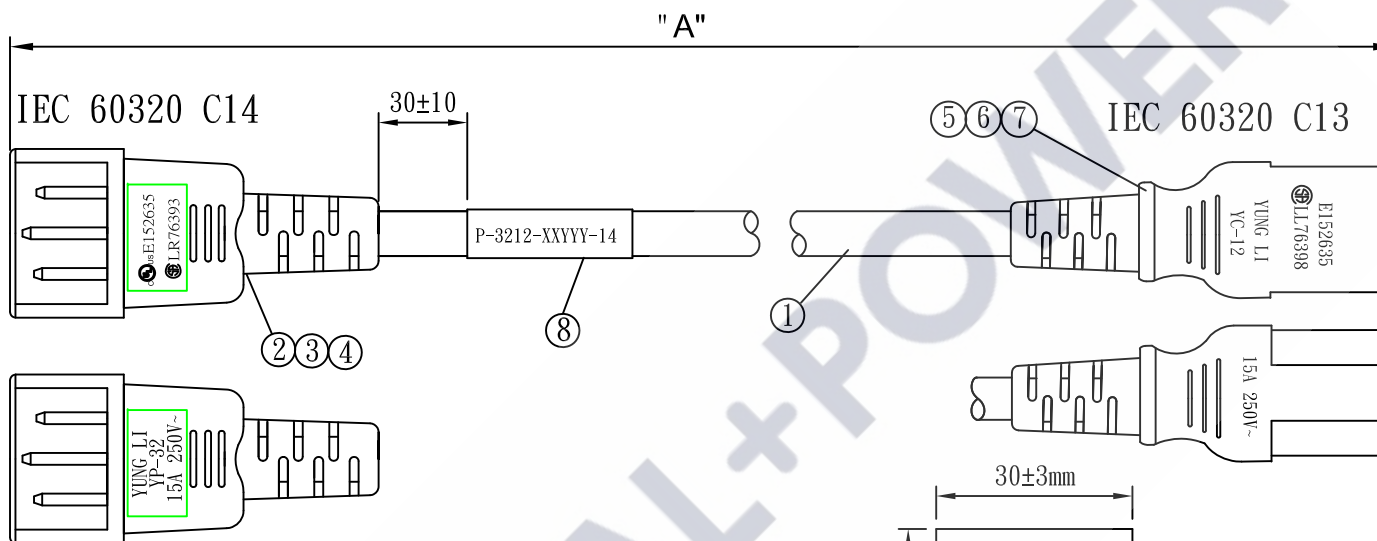
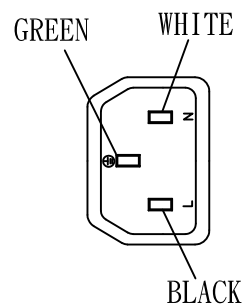

LENGTH: "A"	3FT	4FT	5FT	6FT	7FT	8FT	9FT	10FT
	915±30	1220±50	1530±50	1830±50	2135±50	2440±50	2745±50	3050±50
P/N BLACK	P-3212-03BLK-14	P-3212-04BLK-14	P-3212-05BLK-14	P-3212-06BLK-14	P-3212-07BLK-14	P-3212-08BLK-14	P-3212-09BLK-14	P-3212-10BLK-14
P/N WHITE(RAL9010)	P-3212-03WHT-14	P-3212-04WHT-14	P-3212-05WHT-14	P-3212-06WHT-14	P-3212-07WHT-14	P-3212-08WHT-14	NA	P-3212-10WHT-14
P/N RED(GY-49)	P-3212-03RED-14	P-3212-04RED-14	P-3212-05RED-14	P-3212-06RED-14	P-3212-07RED-14	P-3212-08RED-14	NA	P-3212-10RED-14
P/N BLUE(PT293C)	P-3212-03BLU-14	P-3212-04BLU-14	P-3212-05BLU-14	P-3212-06BLU-14	P-3212-07BLU-14	P-3212-08BLU-14	NA	P-3212-10BLU-14

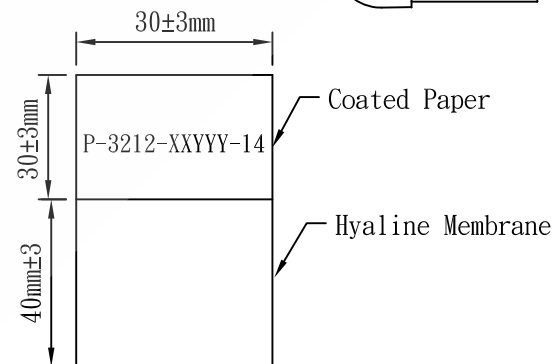

NO.	SPECIFICATION	QTY	REMARK
1	SJT 14/3C 105°C	1PC	
2	YP-32 PVC PLASTIC:50P	15g/PC	
3	TER:98672BS-1	3PCS	
4	INNER BODY: 2X4	1PC	
5	TER:97740	3PCS	
6	YC-12 INNER BODY	1PC	
7	YC-12 PVC PLASTIC:50P	18g/PC	
8	LABEL: (40+30)*30mm	1PC	

Packing: Bundled to ease installation.

Sample Drawing No. :
SP211018-05

Tolerance >0±0.30 >1.0±0.50 >10.0±1.0 >20.0±2.0 Angle: ±1°	Approved	Date	SIGNAL+POWER			
	Checked	Date				
	Drawn	SUKI	Date	21.10.18	Customer	
	Cat. No.	UL YP-32/YC-12		P/N.	P-3212-XXYYY-14	
	Drawing No.	Rev.	B	Material	P.V.C	Unit mm
			Scale			

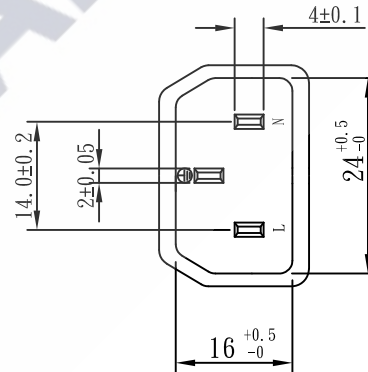
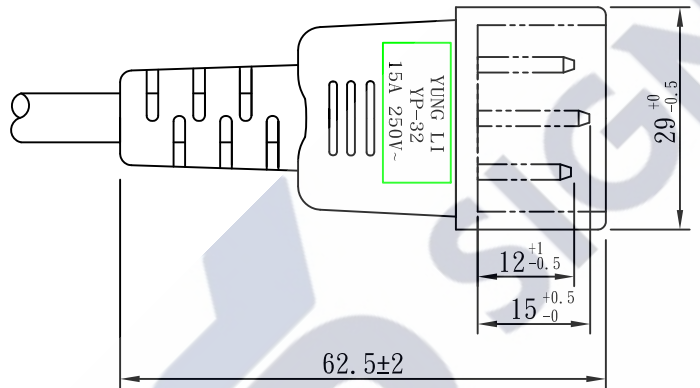
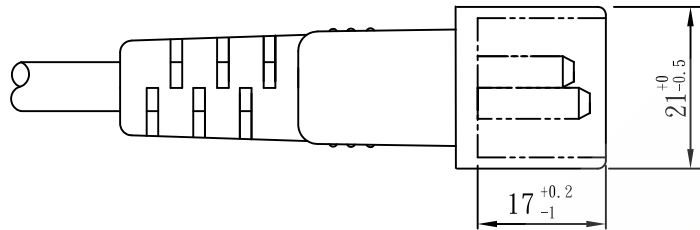
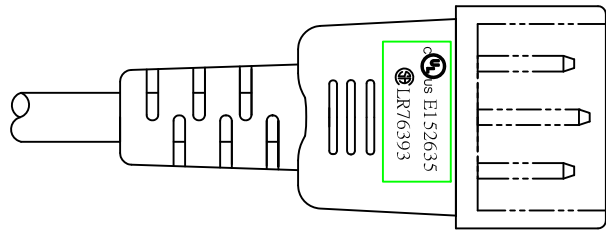

TOLERANCE >0±0.30 >1.0±0.50 >10.0±1.0 >20.0±2.0 Angle: ±1°	APPROVED		DATE		YUNG LI CO., LTD			
	CHECKED		DATE					
	DRAWN	MELON	DATE	19.04.08	CUSTOMER			
	TYPE	YP-32			P/N			
	DRAWING NO.	CY-P32U15A	REV	B	MATERIAL	P. V. C	UNIT	mm
				SCALE	1:1			

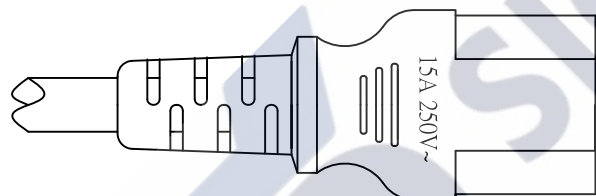
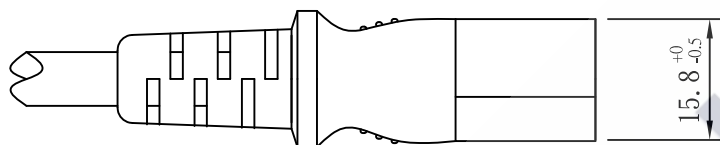
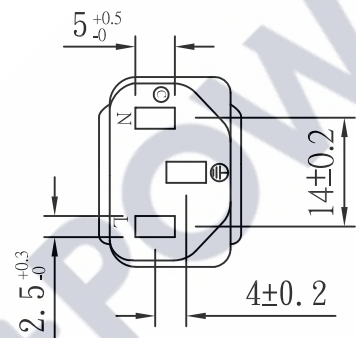
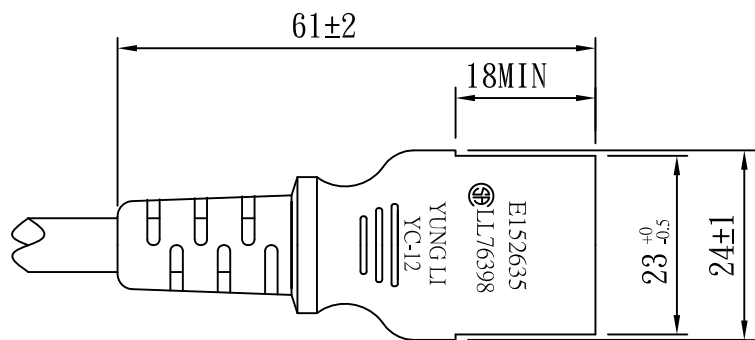

TOLERANCE >0±0.30 >1.0±0.50 >10.0±1.0 >20.0±2.0 Angle: ±1°	APPROVED		DATE		YUNG LI CO., LTD			
	CHECKED		DATE					
	DRAWN	周淑萍	DATE	18.04.09	CUSTOMER			
	TYPE	YC-12			P/N			
	DRAWING NO.	CY-C12U15A125VB	REV	B	SCALE	1:1	UNIT	mm

YUNG LI CO., LTD

SPECIFICATION

Yung-Li	Style	PVC FLEXIBLE CORDS	Document No
2017.09.28			
Edition	Size	SJT 14/ 3C 105°C	Page
A			1/2

1. Standard : UL 62 UL 1581

2. Construction & Dimension

	Item	Specification
Conductor	Size	14AWG X 3C
	Material	Annealed Bare Copper
	Construction	41/ ϕ 0.254 \pm 0.003
Insulation	Material	PVC
	Minimum Average Thickness	0.76mm
	Minimum Thickness at any point	0.69mm
	Diameter	3.5 \pm 0.10
	Identification	Black White Green
Core Assembly	Core Twist	3-Core
	Filler	NA
	Assembly Pair	NA
Taping	Mylar Foil	NA
Shielded	A1-Mylar Foil	NA
Drain Wire	Material	NA
	Construction	NA
Jacket	Material	PVC
	Minimum Average Thickness	0.76mm
	Minimum Thickness at any point	0.61mm
	Overall Diameter(Approx)	9.3 \pm 0.15
	Color	Any Color

Marking :

YUNG LI (UL) E241374 SJT 3/C 14AWG(2.08mm²) 105°C 300V VW-1
 CSA 177323 SJT 3/C 14AWG(2.08mm²) 105°C 300V FT2

YUNG LI CO., LTD

SPECIFICATION

Yung-Li	Style	PVC FLEXIBLE CORDS	Document No
2017.09.28			
Edition	Size	SJT 14/ 3C 105°C	Page
A			2/2

3. Electrical & Physical Properties			
Item		Specification	
Rating Voltage		300V	
Insulation Resistance		$\geq 0.76\text{M}\Omega/\text{Km}$ 15.0°C Min	
Dielectric Strength		AC 2.0KV/1 min No Crack	
Spark Test		6.0KV/0.15 Sec	
Insulation	Unaged	Tensile Strength	1500 lbs/in ² min
		Elongation	100%Min
	Aged	Tensile Strength	Min 85%(136±1°C x168hrs)
		Elongation	Min 65%(136±1°C x168hrs)
Jacket	Unaged	Tensile Strength	1500 lbs/in ² min
		Elongation	100%Min
	Aged	Tensile Strength	Min 85%(136±1°C x168hrs)
		Elongation	Min 45%(136±1°C x168hrs)
Deformation Test		121±1°C m X 1hr $\leq 50\%$	
Cold Bend Test		-20°C x 4hr No Crack	
Heat Shock Test		121±1°C x 1hr No Crack	

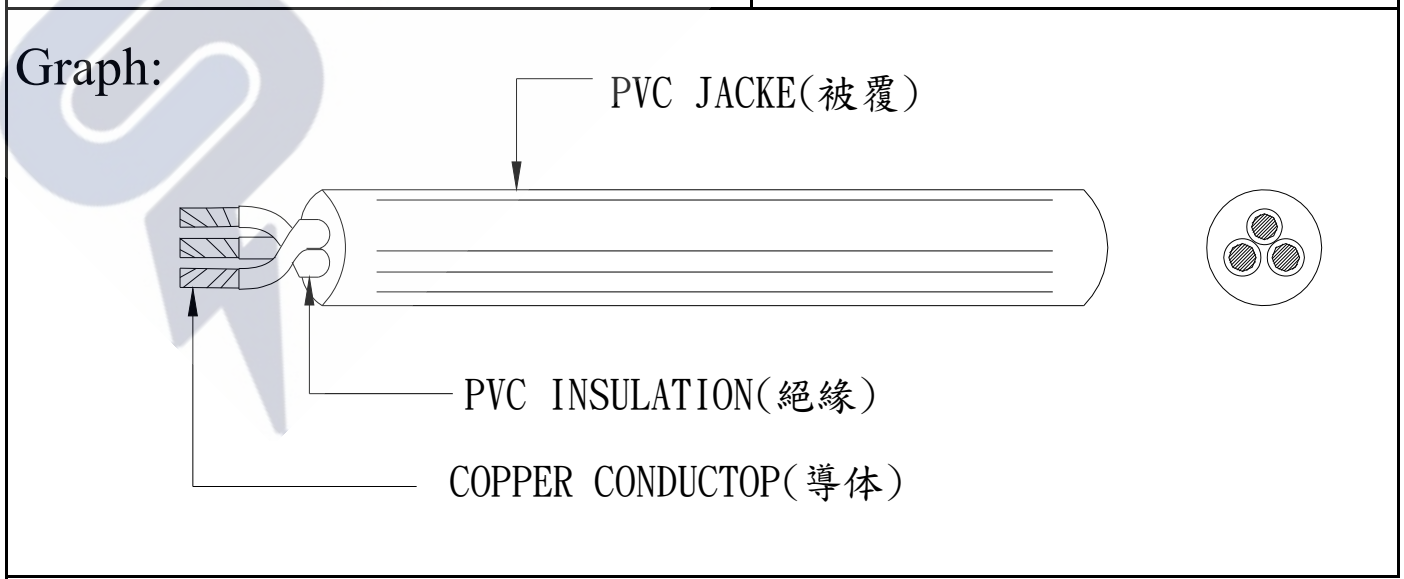

ELBZ7.E152635 - Cord Sets and Power-supply Cords Certified for Canada

Cord Sets and Power-supply Cords Certified for Canada

See General Information for Cord Sets and Power-supply Cords Certified for Canada

YUNG LI CO LTD

7F-12 NO 99 SEC 1 XINTAI 5TH RD
XIZHI DISTRICT
NEW TAIPEI, 22175 TAIWAN

Power-supply cords

E152635

Cat. No.	ANSI/NEMA WD6 Config	Cord AWG	Cord Type	Electrical Rating Amps V
YP-11	1-15	18/2	SPT-1, SPT-2, SPT-3, NISPT-2, SVT, SVTO, SJT, SJTW, SJTO, SJTOW (All TPE material), SPT-1, SPT-1W, NISPT-1, SPT-2, SPT-2W, NISPT-2, SPT-3, HPN, SVT, SVTO, SJT, SJTW, SJTO, SJTOW, SV, SVO, SJ, SJO, SJOW, SJOOW, EVT, EVJT, EVE, EVJE	7 or 10/125
		17/2	SVT, SVTO (All TPE material), SVT, SVTO, SV, SVO, SJ, SJO, SJOW, SJOOW, EVT, EVJT, EVE, EVJE	12/125
		16/2	SPT-2, SPT-3, NISPT-2, SVT, SVTO, SJT, SJTW, SJTO, SJTOW (All TPE material), SPT-2, SPT-2W, NISPT-2, SPT-3, SVT, SVTO, SJT, SJTW, SJTO, SJTOW, SV, SVO, SJ, SJO, SJOW, SJOOW, EVT, EVJT, EVE, EVJE	13/125
		16/2	HPN	15/125
		14/2	SPT-3, SJT, SJTW, SJTO, SJTOW (All TPE material), SPT-3, SJT, SJTW, SJTO, SJTOW, SJ, SJO, SJOW, SJOOW, EVT, EVJT, EVE, EVJE	15/125
YP-11W	1-15P	18/2	SPT-1, SPT-2, SPT-3, NISPT-2, SVT, SVTO, SJT, SJTW, SJTO, SJTOW (All TPE material), SPT-1, SPT-1W, NISPT-1, SPT-2, SPT-2W, NISPT-2, SPT-3, HPN, SVT, SVTO, SJT, SJTW, , SJTO, SJTOW, SV, SVO, SJ, SJO, SJOW, SJOOW, EVT, EVJT, EVE, EVJE	7 or 10/125
		17/2	SVT, SVTO (All TPE material), SVT, SVTO, SV, SVO, SJ, SJO, SJOW, SJOOW, EVT, EVJT, EVE, EVJE	12/125
		16/2	SPT-2, SPT-3, NISPT-2, SVT, SVTO, SJT, SJTW, SJTO, SJTOW (All TPE material), SPT-2, SPT-2W, NISPT-2, SPT-3, SVT, SVTO, SJT, SJTW, SJTO, SJTOW, SV, SVO, SJ, SJO, SJOW, SJOOW, EVT, EVJT, EVE, EVJE	13/125
		16/2	HPN	15/125
		14/2	SPT-3, SJT, SJTW, SJTO, SJTOW (All TPE material), SPT-3, SJT, SJTW, SJTO, SJTOW, SJ, SJO, SJOW, SJOOW, EVT, EVJT, EVE, EVJE	15/125

		14/3	SJT, SJTW, SJTO, SJTOW, ST, STW, STOW, SPT-3 (All TPE material), SJT, SJTW, SJTO, SJTOW, ST, STW, STOW, SO, SOW, SOOW, SPT-3, EVT, EVJT, EVE, EVJE	15/250
		12/3	SJT, SJTW, SJTO, SJTOW, ST, STW, STOW, SPT-3 (All TPE material), SJT, SJTW, SJTO, SJTOW, ST, STW, STOW, SO, SOW, SOOW, SPT-3, EVT, EVJT, EVE, EVJE	15/250
YP-31	IEC C8	18/2	SVT, SVTO, SJT, SJTW, SJTO, SJTOW, SPT-1, SPT-2, NISPT-2 (All TPE material), SVT, SVTO, SJT, SJTW, SJTO, SJTOW, SV, SVO, SJ, SJO, SJOW, SJOOW, SPT-1, SPT-1W, SPT-2, SPT-2W, NISPT-1, NISPT-2, EVT, EVJT, EVE, EVJE	7/125, 2.5/250
YP-32, YP-32L, YP-32L-1, YP-32L-2, YP-32L-3	IEC C14	18/3	SVT, SJT, SJTW, SJTO, SJTOW, ST, STW, STOW (All TPE material, Shielded and Non-shielded for all types), SVT, SJT, SJTW, SJTO, SJTOW, ST, STW, STOW, SJ, SJO, SJO, SJOW, SJOOW, SO, SOO, SOW, SOOW (Shielded or Non-shielded for all types), EVT, EVJT, EVE, EVJE	2.5, 7 or 10/125 or 250
		17/3	SVT, SJT, SJTW, SJTO, SJTOW, ST, STW, STOW (All TPE material, Shielded and Non-shielded for all types), SVT, SJT, SJTW, SJTO, SJTOW, ST, STW, STOW, SJ, SJO, SJO, SJOW, SJOOW, SO, SOO, SOW, SOOW (Shielded or Non-shielded for all types), EVT, EVJT, EVE, EVJE	10, 12/125 or 250
		16/3	SJT, SJTW, SJTO, SJTOW, ST, STW, STOW (All TPE material, Shielded and Non-shielded for all types), SJT, SJTW, SJTO, SJTOW, ST, STW, STOW, SJ, SJO, SJO, SJOW, SJOOW, SO, SOO, SOW, SOOW (Shielded or Non-shielded for all types), EVT, EVJT, EVE, EVJE	13/125 or 250
		15/3	SJT, SJTW, SJTO, SJTOW, ST, STW, STOW (All TPE material, Shielded and Non-shielded for all types), SJT, SJTW, SJTO, SJTOW, ST, STW, STOW, SJ, SJO, SJO, SJOW, SJOOW, SO, SOO, SOW, SOOW (Shielded or Non-shielded for all types), EVT, EVJT, EVE, EVJE	14/125 or 250
		14/3	SJT, SJTW, SJTO, SJTOW, ST, STW, STOW (All TPE material, Shielded and Non-shielded for all types), SJT, SJTW, SJTO, SJTOW, ST, STW, STOW, SJ, SJO, SJO, SJOW, SJOOW, SO, SOO, SOW, SOOW (Shielded or Non-shielded for all types), EVT, EVJT, EVE, EVJE	15/125 or 250
YP-12D	5-15	18/3	SVT, SJT, SJT Shielded, SJTW, SJTO, SJTOW (All TPE material), SVT, SJT, SJT Shielded, SJTW, SJTO, SJTOW, EVT, EVJT, EVE, EVJE	7 or 10/125
		16/3	SVT, SJT, SJT Shielded, SJTW, SJTO, SJTOW (All TPE material), SVT, SJT, SJT Shielded, SJTW, SJTO, SJTOW, EVT, EVJT, EVE, EVJE	13/125
		14/3	SVT, SJT, SJT Shielded, SJTW, SJTO, SJTOW (All TPE material), SVT, SJT, SJT Shielded, SJTW, SJTO, SJTOW, EVT, EVJT, EVE, EVJE	15/125
YP-32A	IEC C14	18/3	SVT, SJT, SJT Shielded, SJTW, SJTO, SJTOW (All TPE material), SVT, SJT, SJT Shielded, SJTW, SJTO, SJTOW, EVT, EVJT, EVE, EVJE	2.5, 7 or 10/250
		16/3	SVT, SJT, SJT Shielded, SJTW, SJTO, SJTOW (All TPE material), SVT, SJT, SJT Shielded, SJTW, SJTO, SJTOW, EVT, EVJT, EVE, EVJE	13/250

		8/3	S, SO, SOW, SOO, SOOW, ST, STW, STO, STOW, STOO, STOOW	30/277 Vac
YP-12R, YP-12R-1	5-15P	18/3	SJ, SJO, SJOW, SJOO, SJOOW, S, SO, SOW, SOO, SOOW, SVT, SVTO, SJT, SJTW, SJTO, SJTOW, SJTOO, SJTOOW, ST, STW, STO, STOW, STOO, STOOW	10/125
		16/3	SJ, SJO, SJOW, SJOO, SJOOW, S, SO, SOW, SOO, SOOW, SJT, SJTW, SJTO, SJTOW, SJTOO, SJTOOW, ST, STW, STO, STOW, STOO, STOOW	13/125
		14/3	SJ, SJO, SJOW, SJOO, SJOOW, S, SO, SOW, SOO, SOOW, SJT, SJTW, SJTO, SJTOW, SJTOO, SJTOOW, ST, STW, STO, STOW, STOO, STOOW	15/125
		12/3	SJ, SJO, SJOW, SJOO, SJOOW, SJT, SJTW, SJTO, SJTOW, SJTOO, SJTOOW	15/125

Special-use cord sets

Cat. No.	IEC 320 Cord Config AWG	Cord Type	Electrical Rating Amps V	
YC-11	IEC C17	18	SPT-1, SPT-2, SPT-3, NISPT-2, SVT, SJT, SJTO, SJTOW, ST, STW, STOW (All TPE material), SPT-1, SPT-2, NISPT-1, NISPT-2, SPT-3, SVT, SJT, SJTO, SJTW, SJTOW, ST, STW, STOW, SO, SOW, SOOW	2.5, 7 or 10/125 or 250
		17	SPT-3, SVT, SJT, SJTW, SJTO, SJTOW, ST, STW, STOW (All TPE material), SPT-3, SVT, SJT, SJTW, SJTO, SJTOW, ST, STW, STOW, SO, SOW, SOOW	10, 12/125 or 250
		16	SPT-2, SPT-3, NISPT-2, SVT, SJT, SJTW, SJTO, SJTOW, ST, STW, STOW (All TPE material), SPT-2, NISPT-2, SPT-3, SVT, SJT, SJTW, SJTO, SJTOW, ST, STW, STOW, SO, SOW, SOOW	13/125 or 250
YC-12, YC-12L, YC-12L-1, YC-12L-2, YC-12L-3	IEC C13	18	SVT, SJT, SJTW, SJTO, SJTOW, ST, STW, STOW (Shielded and Non-shielded for all types), SPT-2, SPT-3 (All TPE material), SVT, SJT, SJTW, SJTO, SJTOW, SJ, SJO, SJOO, SJOW, SJOOW, ST, STW, STOW, SO, SOO, SOW, SOOW (Shielded or Non-Shielded for above types), SPT-2, SPT-3	2.5, 7 or 10/125 or 250
		17	SVT, SJT, SJTW, SJTO, SJTOW, ST, STW, STOW (Shielded and Non-shielded for all types), SPT-3 (All TPE material), SVT, SJT, SJTW, SJTO, SJTOW, ST, STW, STOW, SJ, SJO, SJOO, SJOW, SJOOW, SO, SOO, SOW, SOOW (Shielded or Non-shielded for above types), SPT-3	10, 12/125 or 250
		16	SJT, SJTW, SJTO, SJTOW, ST, STW, STOW (Shielded and Non-shielded for all types), SPT-3 (All TPE material), SJT, SJTW, SJTO, SJTOW, ST, STW, STOW, SJ, SJO, SJOO, SJOW, SJOOW, SO, SOO, SOW, SOOW (Shielded or Non-shielded for above types), SPT-2, SPT-3	13/125 or 250
		15	SJT, SJTW, SJTO, SJTOW, ST, STW, STOW (Shielded and Non-shielded for all types), SPT-3 (All TPE material), SJT, SJTW, SJTO, SJTOW, ST, STW, STOW, SJ, SJO, SJOO, SJOW, SJOOW, SO, SOO, SOW, SOOW (Shielded or Non-shielded for above types), SPT-3	10, 14/125 or 250

		14	SJT, SJTW, SJTO, SJTOW, ST, STW, STOW (Shielded and Non-shielded for all types), SPT-3 (All TPE material), SJT, SJTW, SJTO, SJTOW, ST, STW, STOW, SJ, SJO, SJOO, SJOW, SJOOW, SO, SOO, SOW, SOOW (Shielded or Non-shielded for above types), SPT-3	15/125 or 250
		12	SJT, SJTW, SJTO, SJTOW, ST, STW, STOW (All TPE material, Shielded and Non-shielded for all types), SJT, SJTW, SJTO, SJTOW, ST, STW, STOW, SJ, SJO, SJOO, SJOW, SJOOW, SO, SOO, SOW, SOOW (Shielded or Non-shielded for all types)	15/125 or 250
YC-12(A.C.1)	IEC C13	12	SJT, SJTW, SJTO, SJTOW, ST, STW, STOW, SPT-3 (All TPE material), SJT, SJTW, SJTO, SJTOW, ST, STW, STOW, SO, SOW, SOOW, SPT-3	15/125 or 250
		10	SJT, SJTW, SJTO, SJTOW, ST, STW, STOW (All TPE material), SJT, SJTW, SJTO, SJTOW, ST, STW, STOW, SO, SOW, SOOW	15/125 or 250
YC-12C	IEC C13	18	NISPT-2 (TPE), NISPT-2	2.5, 7 or 10/125 or 250
		16	NISPT-2 (TPE), NISPT-2	13/125 or 250
YC-13	IEC C7	18	SPT-1, SPT-2, NISPT-2, SVT, SJT (All TPE material), SPT-1, SPT-1W, SPT-2, SPT-2W, NISPT-1, NISPT-2, SVT, SJT	2.5/250 or 7/125
YC-13W	IEC C7P	18	SPT-1, SPT-2, NISPT-2, SVT, SJT (All TPE material), SPT-1, SPT-1W, SPT-2, SPT-2W, NISPT-1, NISPT-2, SVT, SJT	2.5/250 or 7/125
YC-14	IEC C5	18	SPT-2, SVT, SVT shielded, SVTO, SJT, SJT shielded, SJTW, SJTW shielded, SJTO, SJTOW (All TPE material), SVT, SVT Shielded, SVTO, SJT, SJT Shielded, SJTW, SJTW Shielded, SJTO, SJTOW, SV, SVO, SJ, SJO, SJOW, SJOOW	2.5/250 or 7/125
			SPT-2	
YC-13L	IEC C7	18	SPT-1, SPT-2, NISPT-2, SVT, SJT (All TPE material), SPT-1, SPT-1W, SPT-2, SPT-2W, NISPT-1, NISPT-2, SVT, SJT	2.5/250 or 7/125
YC-13D	IEC C7	18	SPT-1, SPT-2, NISPT-2, SVT, SJT (All TPE material), SPT-1, SPT-1W, SPT-2, SPT-2W, NISPT-1, NISPT-2, SJT, SVT	2.5/250 or 7/125
YC-13C	IEC C7	18	NISPT-2 (All TPE material), NISPT-1, NISPT-2	2.5/250 or 7/125
YC-13E	IEC C7	18	SPT-1, SPT-2, NISPT-2, SVT, SJT (All TPE material), SPT-1, SPT-1W, SPT-2, SPT-2W, NISPT-1, NISPT-2, SVT, SJT	2.5/250 or 7/125
YC-14L, YC-14L-1, YC-14L-2, YC-14L-3	IEC C5	18	SVT, SJT, SPT-2 (All TPE material), SVT, SJT, SPT-2	2.5/250 or 7/125
YC-18	IEC C19	16	SJT, SJTW, SJTO, SJTOW, SJTOOW, ST, STW, STOW, STOOW, SPT-3 (All TPE material), SJT, SJTW, SJTO, SJTOW, SJTOOW, SJ, SJO, SJOO, SJOW, SJOOW, ST, STW, STOW, STOOW, S, SO, SOW, SOO, SOOW, SPT-3	13/125 or 250



Certificate of Compliance

Certificate: 1155953

Master Contract: 177323 (LL 76398)

Project: 2767514

Date Issued: October 17, 2014

Issued to: Yung Li Co., Ltd.
1F, No 10, Lane 235, Pao Chiao Rd.,
Hsien Tien City, Taipei Hsien
TAIWAN
Attention: Mr. David W.D. Lai

The products listed below are eligible to bear the CSA Mark shown



Issued by:

Jupiter Huang

PRODUCTS

CLASS – 5841 03 - CORD SETS - Special-Use Cord Sets

Special use cord set consisting of the following connector body moulded on either of the submittor's Certified power supply cords as indicated:

Female Cat No	Config./Type	Male Cat No	Config.	Max Rating of Cord Set	Cord AWG	Cord Type
YC-12, or YC-12L	(SP23, C13)	YP-12, or YP-12L	5-15P	10A, 125V	18/3	SJT, SVT, SVT(S&U), SPT-2
				13A, 125V	16/3	SJT
				15A, 125V	14/3	SJT
YC-12, or YC-12L	(SP23, C13)	YP-18, or YP-18L	5-15P (HG)	10A, 125V	18/3	SJT, SJTO, SJTOW
				13A, 125V	16/3	SJT, SJTO, SJTOW
				15A, 125V	14/3	SJT, SJTO, SJTOW
YC-14	(SP23, C13)	YP-18, or YP-18L	5-15P (HG)	10A, 125V	18/3	SJT, SJTO, SJTOW



CSA
Group

Certificate: 1155953

Master Contract: 177323 (LL 76398)

Project: 2767514

Date Issued: October 17, 2014

YC-12, or YC-12L	(SP23, C13)	YP-32, or YP- 32L	(SP23, Sd, C14)	10A, 125/250V	18/3	SVT (S&U), SJT(S&U) , SJTW (S&U), SJTO(S&U), SJTOW(S&U), ST(S&U), STW(S&U), STOW(S&U), SJ (S&U), SJO(S&U), SJO(S&U), SJOOW(S&U), SO(S&U), SOO(S&U), SOW(S&U), SOOW(S&U)
				13A, 125/250V	16/3	SJT(S&U) , SJTW (S&U), SJTO(S&U), SJTOW(S&U), ST(S&U), STW(S&U), STOW(S&U), SJ (S&U), SJO(S&U), SJO(S&U), SJOOW(S&U), SO(S&U), SOO(S&U), SOW(S&U), SOOW(S&U)
				15A, 125/250V	14/3	SJT(S&U) , SJTW (S&U), SJTO(S&U), SJTOW(S&U), SJ (S&U), SJO(S&U), SJO(S&U), SJOOW(S&U), SO(S&U), SOO(S&U), SOW(S&U), SOOW(S&U)
YC-14	(SP23, C5)	YP-32, or YP- 32L	(SP23, Sd, C14)	10A, 125/250V	18/3	SVT (S&U), SJT(S&U), SJTOW(S&U), SJTO, SJTOW, SJO, SJOOW

LEGEND: "(S&U)" shielded and unshielded, "(SP23)" Special-use, 2 pole, 3 wires, "(Sd)" Shrouded, "(HG)" Hospital Grade.



CSA
Group

Certificate: 1155953

Master Contract: 177323 (LL 76398)

Project: 2767514

Date Issued: October 17, 2014

APPLICABLE REQUIREMENTS

- CSA Std.C22.2 No. 21-95 - Cord Sets and Power Supply Cords
- CSA Std. C22.2 No. 182.3-M1987 - Special Use Attachment Plugs, Receptacles, and Connectors
- Certification Notice - Wiring Products No. 6
- INFORMS
- Cord Sets No. 7A - Production-Line Test for Cord Sets and Power





Supplement to Certificate of Compliance

Certificate: 1155953

Master Contract: 177323 (LL 76398)

The products listed, including the latest revision described below, are eligible to be marked in accordance with the referenced Certificate.

Product Certification History

Project	Date	Description
2767514	October 16, 2014	Include Cat Nos. YP-12L, YP-18, YP-18L, YC-14.
2183539	July 28, 2009	Include alternative body material, inner body material and blade, for Cat No YC-12.
1868158	March 19, 2007	Include Alternative PVC Compounds to connector, Cat No. YC-12.
1299531	June 6, 2002	Cover Additional Cord Type SPT-2, 18/3 for Special-use Cord Set , Cat No YC-12 with YP-12.
1155953	March, 14, 2001	Special-use Cord Set incorporating Connector Body, Cat No. YC-12 and 5-15P Plug Cap, Cat No. YP-12. (Supersedes Report LL 76398-1 and Covered Additional Cord Type SJT, 14/3 AWG)
LR 76393-7	June 10, 1998	Special-use Cord Sets Covered in Report LL 76398-1 to Comply with CSA Certification Notice-Wiring Products No. 6.
LR 76393-9	June 8, 1998	Special-use Cord Sets to Add Connector Body Cat No YC-12L.
LR 76393-3	February 2, 1996	Cord Sets Incorporating Connector Body Cat No YC-12 to Include Additional Size and Type of Cord.
LR 76393-1	July 8, 1993	Original Certification.(Superseded by Report 1155953)



ZJCZ.E241374 Flexible Cord

[Page Bottom](#)

Flexible Cord

[See General Information for Flexible Cord](#)

YUNG LI CO LTD

E241374

7F-12 NO 99 SEC 1 XINTAI 5TH RD
XIZHI DISTRICT
NEW TAIPEI, 22175 TAIWAN

Decorative cord, Type(s) SPT-1W, SPT-2W

Dryer and range cord, Type(s) SRDT

Jacketed cord, Type(s) S, SE, SE-HF, SJ, SJE, SJE-HF, SJO, SJO, SJOOW, SJOW, SJJ, SJJ-B, SJTO, SJTOW, SJTW, SO, SOO, SOOW, SOW, ST, ST-B, STO, STOW, STW, SVE, SVE-HF, SVT, SVT-B, SVTO

Parallel cord, Type(s) NISPE-1, NISPE-1-HF, NISPE-2, NISPE-2-HF, NISPT-1, NISPT-2, SPE-1, SPE-1-HF, SPE-2, SPE-2-HF, SPE-3, SPE-3-HF, SPT-1, SPT-2, SPT-3

[Last Updated](#) on 2016-03-07

[Questions?](#)

[Print this page](#)

[Terms of Use](#)

[Page Top](#)

◆ 2016 UL LLC

The appearance of a company's name or product in this database does not in itself assure that products so identified have been manufactured under UL's Follow-Up Service. Only those products bearing the UL Mark should be considered to be Certified and covered under UL's Follow-Up Service. Always look for the Mark on the product.

UL permits the reproduction of the material contained in the Online Certification Directory subject to the following conditions: 1. The Guide Information, Assemblies, Constructions, Designs, Systems, and/or Certifications (files) must be presented in their entirety and in a non-misleading manner, without any manipulation of the data (or drawings). 2. The statement "Reprinted from the Online Certifications Directory with permission from UL" must appear adjacent to the extracted material. In addition, the reprinted material must include a copyright notice in the following format: "© 2016 UL LLC".



Certificate of Compliance

Certificate: 1594794 (LL 76398)

Master Contract: 177323

Project: 2616524

Date Issued: April 3, 2013

Issued to: Yung Li Company Ltd.

1F No 10 Lane 235 Pao Chiao Rd
Hsin Tien City
Taipei Hsien,
Taiwan
Attention: Wendy Wu

The products listed below are eligible to bear the CSA Mark shown



Kim Nguyen

Issued by: Kim Nguyen, P. Eng.

PRODUCTS

CLASS 5831 01 - WIRES - Flexible Cord

Types SPT-1, NISPT-1, SPT-2, NISPT-2, SPT-3, SVT, SVTO, SJT, SJTW, SJTO, SJTOW, ST, STW, STO, STOW with PVC insulation and jacket, rated 60C, 75C, 90C and 105C, FT1, FT2, VW-1.

APPLICABLE REQUIREMENTS

CSA C22.2 No 49 - Flexible Cords and Cables