

# 東莞永力電業有限公司

YUNG LI CO., LTD

Da Pu Industrial Zone, Gang Zi, Changping Town,  
Dong Guan City, Guangdong 523571 China.P.R.C

TEL:0769-83396797~8

FAX:0769-83396796

E-mail: sales@yung-li.com

Description: YP-16/YC-18

Customer: SIGNAL+POWER

Parts No. : P-1618-06B

Draw No. :

## REVISION RECORD

1		
2		
3		
4		
5		

YUNG LI	
CHECKED	PREPARED BY

CUSTOMER	APPROVED



(6')1830±50

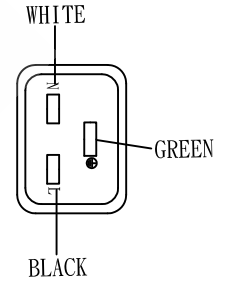
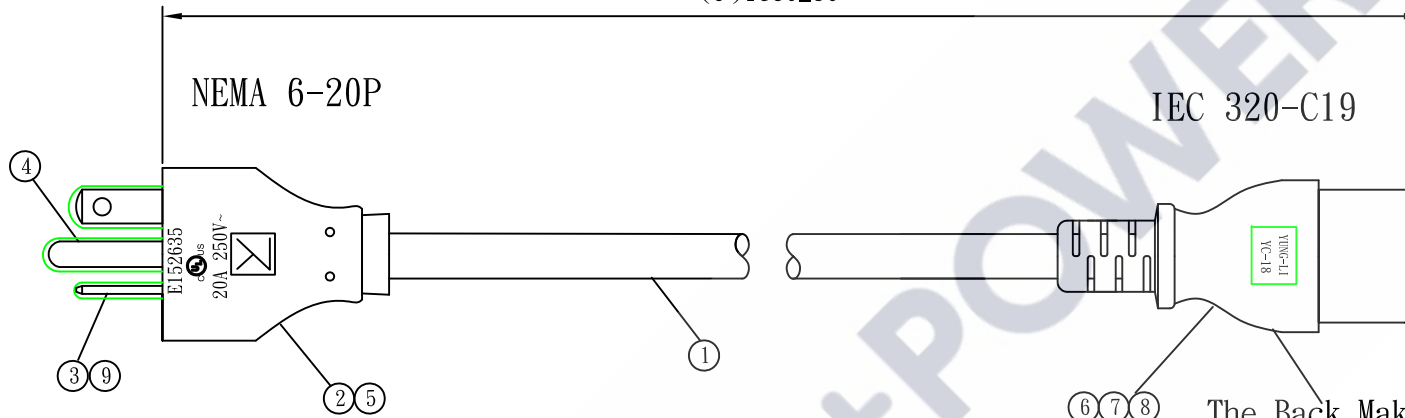
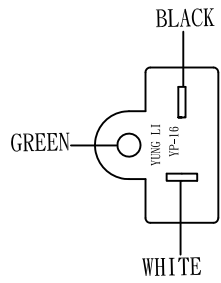

The Back Making  
E152635  
20A 250V~

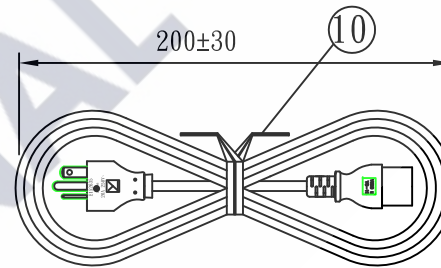

NO.	SPECIFICATION	QTY	REMARK
1	SJT 12/3C 105°C BLACK	1PC	
2	YP-16 PVC PLASTIC:35P BLACK	27g/PC	
3	TER:98673BS-1	2PCS	
4	TER:98475BS-1	1PC	
5	YP-16 INNER BODY	1PC	
6	YC-18 PVC PLASTIC:50P BLACK	25g/PC	
7	YC-18 INNER BODY	1PC	
8	YC-18 TER	3PCS	
9	SLEEVE:3PIN WHITE	1PC	
9	MINI TIE:L=180mm BLACK	1PC	

Tolerance >0±0.30 >1.0±0.50 >10.0±1.0 >20.0±2.0 Angle: ±1°	Approved		Date		<b>SIGNAL+POWER</b>			
	Checked		Date					
	Drawn	SUKI	Date	22.09.05	Customer			
	Cat. No.	YP-16/YC-18			P/N.	P-1618-06B		
	Drawing No.	CY-U4731	Rev.	C	Material	P. V. C	Unit	mm
				Scale				



NEMA 6-20P

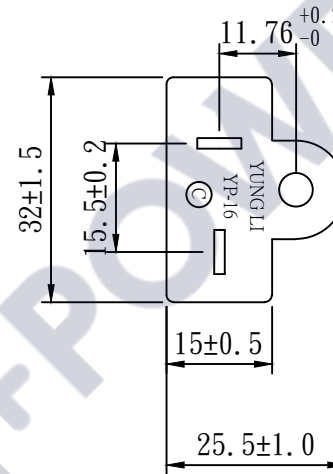
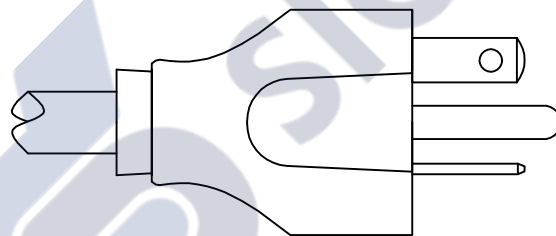
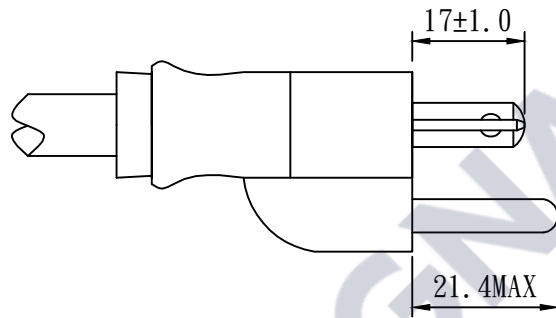
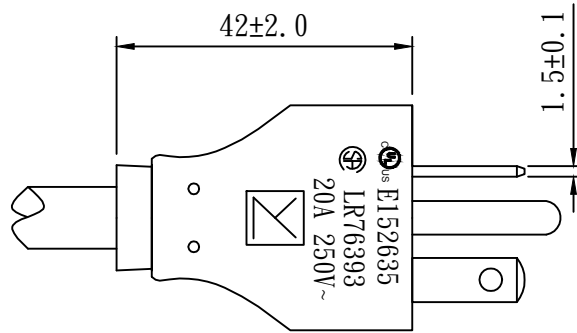

TOLERANCE >0±0.30 >1.0±0.50 >10.0±1.0 >20.0±2.0 Angle: ±1°	APPROVED		DATE		YUNG LI CO., LTD					
	CHECKED		DATE							
	DRAWN		DATE		CUSTOMER					
	TYPE	YP-16				P/N				
	DRAWING NO.		REV	B	MATERIAL	P. V. C	UNIT	mm		
				SCALE	1:1					

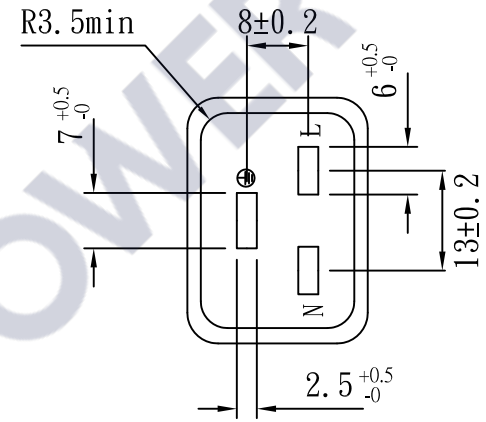
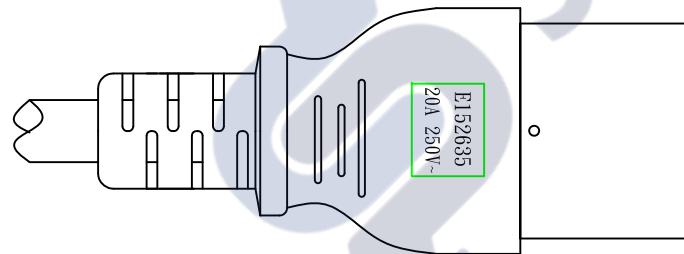
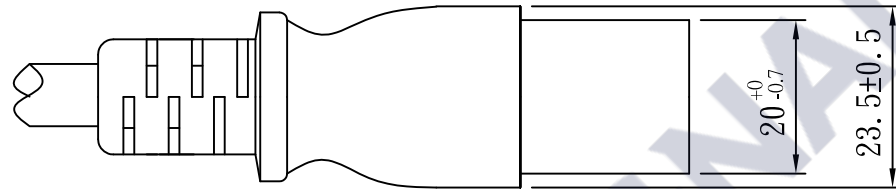
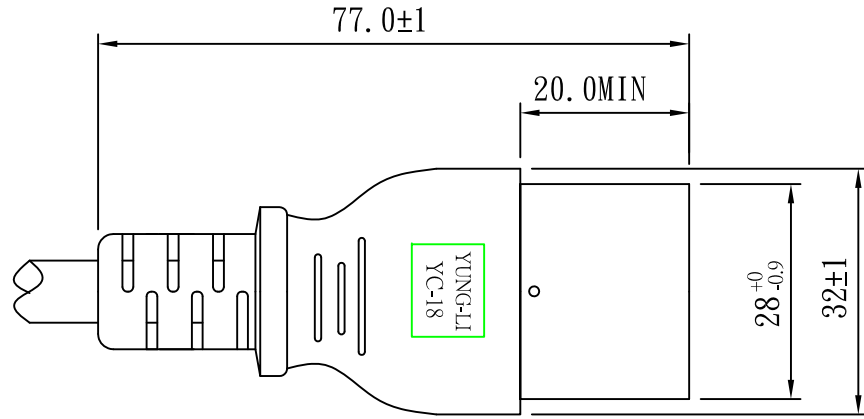

TOLERANCE >0±0.30 >1.0±0.50 >10.0±1.0 >20.0±2.0 Angle: ±1°	APPROVED		DATE		YUNG LI CO., LTD			
	CHECKED		DATE					
	DRAWN		DATE		CUSTOMER			
	TYPE	YC-18			P/N			
	P/N				MATERIAL	P. V. C	UNIT	mm
	DRAWING NO.		REV	B	SCALE	1:1		

# YUNG LI CO., LTD

## SPECIFICATION

Yung-Li	Style	PVC FLEXIBLE CORDS	Document No
2007.8.02			
Edition	Size	<b>SJT 12/ 3C 105°C</b>	Page
A			1/2

1. Standard : UL 62 UL 1581

### 2. Construction & Dimension

	Item	Specification
Conductor	Size	12AWG X 3C
	Material	Annealed Bare Copper
	Construction	65/φ 0.254±0.003
Insulation	Material	PVC
	Minimum Average Thickness	0.76mm
	Minimum Thickness at any point	0.69mm
	Diameter	4.0 ± 0.10
	Identification	Black White Green
Core Assembly	Core Twist	3-Core
	Filler	Cotton 18000D
	Assembly Pair	NA
Taping	Mylar Foil	NA
Shielded	A1-Mylar Foil	NA
Drain Wire	Material	NA
	Construction	NA
Jacket	Material	PVC
	Minimum Average Thickness	1.14mm
	Minimum Thickness at any point	0.91mm
	Overall Diameter(Approx)	11.2± 0.2
	Color	Any Color

### Marking :

**YUNG LI (UL) E241374 SJT 3/C 12AWG(3.31mm<sup>2</sup>) 105°C 300V VW-1**  
**CSA 177323 SJT 3/C 12AWG(3.31mm<sup>2</sup>) 105°C 300V FT2**

# YUNG LI CO., LTD

## SPECIFICATION

Yung-Li	Style	PVC FLEXIBLE CORDS	Document No
2007.8.02			
Edition	Size	<b>SJT 12/ 3C 105°C</b>	Page
A			2/2

3. Electrical & Physical Properties			
Item		Specification	
Rating Voltage		300V	
Insulation Resistance		$\geq 0.76\text{M}\Omega/\text{Km}$ 15.0°C Min	
Dielectric Strength		AC 2.0KV/1 min No Crack	
Spark Test		6.0KV/0.15 Sec	
Insulation	Unaged	Tensile Strength	1500 lbs/in <sup>2</sup> min
		Elongation	100%Min
	Aged	Tensile Strength	Min 85%(136±1°Cx168hrs)
		Elongation	Min 65%(136±1°Cx168hrs)
Jacket	Unaged	Tensile Strength	1500 lbs/in <sup>2</sup> min
		Elongation	100%Min
	Aged	Tensile Strength	Min 85%(136±1°Cx168hrs)
		Elongation	Min 45%(136±1°Cx168hrs)
Deformation Test		121±1°Cm X 1hr $\leq$ 50%	
Cold Bend Test		-20°C x 4hr No Crack	
Heat Shock Test		121±1°C x 1hr No Crack	

**Graph:**

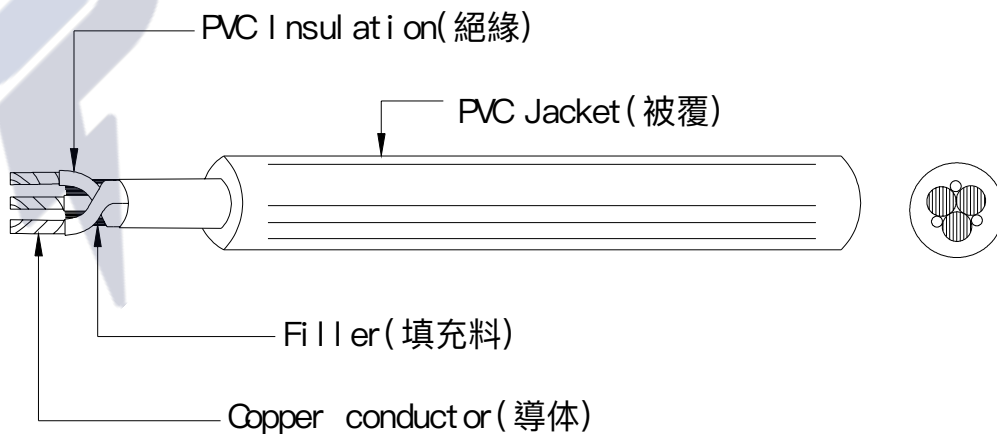

**ELBZ7.E152635****Cord Sets and Power-supply Cords Certified for Canada**

Page Bottom

**Cord Sets and Power-supply Cords Certified for Canada**See General Information for Cord Sets and Power-supply Cords Certified for Canada**YUNG LI CO LTD**

E152635

1ST FL

10 LANE 235 PAO-CHIAO RD

HSIN-TIEN, TAIPEI HSIEN 231 TAIWAN

**Power-supply cords**

Cat. No.	ANSI/NEMA WD6 Config	Cord AWG	Cord Type	Electrical Rating Amps V
YP-11	1-15	18/2	SPT-1, SPT-1W, NISPT-1, SPT-2, SPT-2W, NISPT-2, SPT-3, HPN, SVT, SVTO, SJT, SJTW, SJTO, SJTOW, SV, SVO, SJ, SJO, SJOW, SJOOW	10/125
		17/2	SVT, SVTO, SV, SVO, SJ, SJO, SJOW, SJOOW	12/125
		16/2	SPT-2, SPT-2W, NISPT-2, SPT-3, SVT, SVTO, SJT, SJTW, SJTO, SJTOW, SV, SVO, SJ, SJO, SJOW, SJOOW	13/125
		16/2	HPN	15/125
		14/2	SPT-3, SJT, SJTW, SJTO, SJTOW, SJ, SJO, SJOW, SJOOW	15/125
YP-11W	1-15P	18/2	SPT-1, SPT-1W, NISPT-1, SPT-2, SPT-2W, NISPT-2, SPT-3, HPN, SVT, SVTO, SJT, SJTW, , SJTO, SJTOW, SV, SVO, SJ, SJO, SJOW, SJOOW	10/125
		17/2	SVT, SVTO, SV, SVO, SJ, SJO, SJOW, SJOOW	12/125
		16/2	SPT-2, SPT-2W, NISPT-2, SPT-3, SVT, SVTO, SJT, SJTW, SJTO, SJTOW, SV, SVO, SJ, SJO, SJOW, SJOOW	13/125
		16/2	HPN	15/125
		14/2	SPT-3, SJT, SJTW, SJTO, SJTOW, SJ, SJO, SJOW, SJOOW	15/125
YP-11C	1-15	18/2	NISPT-1, NISPT-2	10/125
YP-12	5-15	18/3	SVT, SVT Shielded, SVTO, SJT, SJT Shielded, SJTW, SJTW Shielded, SJTO, SJTO Shielded, SJTOW, SJTOW Shielded, ST, ST Shielded, STW, STW Shielded, STOW, STOW Shielded, SV, SVO, SJ, SJ Shielded, SJO, SJO Shielded, SJOOW, SJOOW Shielded, S, SO, SO Shielded, SOO, SOO Shielded, SOW, SOW Shielded, SOOW, SOOW Shielded, SPT-2, SPT-3	10/125
		17/3	SVT, SVTO, SV, SVO	12/125
		16/3	SVT, SVT Shielded, SVTO, SJT, SJT Shielded, SJTW, SJTW Shielded, SJTO, SJTO Shielded, SJTOW, SJTOW Shielded, ST, ST Shielded, STW, STW Shielded, STOW, STOW Shielded, SV, SVO, SJ, SJ Shielded, SJO, SJO Shielded, SJOOW, SJOOW Shielded, S, SJOW, SJOW Shielded, SJOOW, SJOOW Shielded, S,	13/125

			SO, SO Shielded, SOO, SOO Shielded, SOW, SOW Shielded, SOOW, SOOW Shielded, SPT-2, SPT-3	
		14/3	SJT, SJT Shielded, SJTW, SJTW Shielded, SJTO, SJTO Shielded, SJTOW, SJTOW Shielded, ST, ST Shielded, STW, STW Shielded, STOW, STOW Shielded, SJ, SJ Shielded, SJO, SJO Shielded, SJOO, SJOO Shielded, SJOW, SJOW Shielded, SJOOW, SJOOW Shielded, S, SO, SO Shielded, SOO, SOO Shielded, SOW, SOW Shielded, SOOW, SOOW Shielded, SPT-3	15/125
		12/3	SJT, SJT Shielded, SJTW, SJTW Shielded, SJTO, SJTO Shielded, SJTOW, SJTOW Shielded, ST, ST Shielded, STW, STW Shielded, STOW, STOW Shielded, SJ, SJ Shielded, SJO, SJO Shielded, SJOO, SJOO Shielded, SJOW, SJOW Shielded, SJOOW, SJOOW Shielded, S, SO, SO Shielded, SOO, SOO Shielded, SOW, SOW Shielded, SOOW, SOOW Shielded, SPT-3	15/125
YP-12L	5-15	18/3	SVT, SVT shielded, SJT, SJTW, SJTO, SJTOW, ST, STW, STOW, SO, SOW, SOOW, SPT-2, SPT-3	10/125
		16/3	SVT, SJT, SJTW, SJTO, SJTOW, ST, STW, STOW, SO, SOW, SOOW, SPT-2, SPT-3	13/125
		14/3	SJT, SJTW, SJTO, SJTOW, ST, STW, STOW, SO, SOW, SOOW, SPT-3	15/125
		12/3	SJT, SJTW, SJTO, SJTOW, ST, STW, STOW, SO, SOW, SOOW	15/125
YP-12L(A.C.1)	5-15	18/3	NISPT-2	10/125
		16/3	NISPT-2	13/125
YP-16	6-20	18/3	SVT, SVT Shielded, SVTO, SJT, SJT Shielded, SJTW, SJTW Shielded, SJTO, SJTOW, ST, STW, STOW, SV, SVO, SJ, SJO, SJOW, SJOOW, S, SO, SOW, SOOW, SPT-2, SPT-3	10/250
		17/3	SVT, SVTO, SV, SVO	12/250
		16/3	SVT, SVTO, SJT, SJTW, SJTO, SJTOW, ST, STW, STOW, SV, SVO, SJ, SJO, SJOW, SJOOW, S, SO, SOW, SOOW, SPT-2, SPT-3	13/250
		14/3	SJT, SJTW, SJTO, SJTOW, ST, STW, STOW, SJ, SJO, SJOW, SJOOW, S, SO, SOW, SOOW, SPT-3	18/250
		12/3	SJT, SJTW, SJTO, SJTOW, ST, STW, STOW, SJ, SJO, SJOW, SJOOW, S, SO, SOW, SOOW, SPT-3	20/250
YP-16L	6-20	18/3	SJT, SJTW, SJTO, SJTOW, ST, STW, STOW, SO, SOW, SOOW	10/250
		16/3	SJT, SJTW, SJTO, SJTOW, ST, STW, STOW, SO, SOW, SOOW	13/250
		14/3	SJT, SJTW, SJTO, SJTOW, ST, STW, STOW, SO, SOW, SOOW, SPT-3	18/250
		12/3	SJT, SJTW, SJTO, SJTOW, ST, STW, STOW, SO, SOW, SOOW, SPT-3	20/250
YP-17	5-20	18/3	SVT, SVT Shielded, SVTO, SJT, SJT Shielded, SJTW, SJTW Shielded, SJTO, SJTOW, ST, STW, STOW, SV, SVO, SJ, SJO, SJOW, SJOOW, S, SO, SOW, SOOW, SPT-2, SPT-3	10/125
		17/3	SVT, SVTO, SV, SVO	12/125
		16/3	SVT, SVTO, SJT, SJTW, SJTO, SJTOW, ST, STW, STOW, SV, SVO, SJ, SJO, SJOW, SJOOW, S, SO, SOW, SOOW, SPT-2, SPT-3	13/125
		14/3	SJT, SJTW, SJTO, SJTOW, ST, STW, STOW, SJ, SJO, SJOW, SJOOW, S, SO, SOW, SOOW, SPT-3	18/125



YC-12, YC-12L, YC-12L-1, YC-12L-2, YC-12L-3	IEC C13	18	SVT, SVT Shielded, SJT, SJT Shielded, SJTW, SJTW Shielded, SJTO, SJTO Shielded, SJTOW, SJTOW Shielded, SJ, SJ Shielded, SJO, SJO Shielded, SJOO, SJOO Shielded, SJOW, SJOW Shielded, SJOOW, SJOOW Shielded, ST, ST Shielded, STW, STW Shielded, STOW, STOW Shielded, SO, SO Shielded, SOO, SOO Shielded, SOW, SOW Shielded, SOOW, SOOW Shielded, SPT-2, SPT-3	10/125 or 250
		16	SJT, SJT Shielded, SJTW, SJTW Shielded, SJTO, SJTO Shielded, SJTOW, SJTOW Shielded, ST, ST Shielded, STW, STW Shielded, STOW, STOW Shielded, SJ, SJ Shielded, SJO, SJO Shielded, SJOO, SJOO Shielded, SJOW, SJOW Shielded, SJOOW, SJOOW Shielded, SO, SO Shielded, SOO, SOO Shielded, SOW, SOW Shielded, SOOW, SOOW Shielded, SPT-3	13/125 or 250
		14	SJT, SJT Shielded, SJTW, SJTW Shielded, SJTO, SJTO Shielded, SJTOW, SJTOW Shielded, ST, ST Shielded, STW, STW Shielded, STOW, STOW Shielded, SJ, SJ Shielded, SJO, SJO Shielded, SJOO, SJOO Shielded, SJOW, SJOW Shielded, SJOOW, SJOOW Shielded, SO, SO Shielded, SOO, SOO Shielded, SOW, SOW Shielded, SOOW, SOOW Shielded, SPT-3	15/125 or 250
		12	SJT, SJT Shielded, SJTW, SJTW Shielded, SJTO, SJTO Shielded, SJTOW, SJTOW Shielded, ST, ST Shielded, STW, STW Shielded, STOW, STOW Shielded, SJ, SJ Shielded, SJO, SJO Shielded, SJOO, SJOO Shielded, SJOW, SJOW Shielded, SJOOW, SJOOW Shielded, SO, SO Shielded, SOO, SOO Shielded, SOW, SOW Shielded, SOOW, SOOW Shielded	15/125 or 250
YC-12 (A.C.1)	IEC C13	12	SJT, SJTW, SJTO, SJTOW, ST, STW, STOW, SO, SOW, SOOW, SPT-3	125/250
		10	SJT, SJTW, SJTO, SJTOW, ST, STW, STOW, SO, SOW, SOOW	125/250
YC-12C	IEC C13	18	NISPT-2	125/250
		16	NISPT-2	125/250
YC-13	IEC C7	18	SPT-1, SPT-1W, SPT-2, SPT-2W, NISPT-2, SVT, SJT NISPT-1	125
YC-13W	IEC C7P	18	SPT-1, SPT-1W, SPT-2, SPT-2W, NISPT-2	125
YC-14	IEC C5	18	SVT, SVT Shielded, SVTO, SJT, SJT Shielded, SJTW, SJTW Shielded, SJTO, SJTOW, SV, SVO, SJ, SJO, SJOW, SJOOW SPT-2	10/125 or 250
YC-13L	IEC C7	18	SPT-1, SPT-1W, SPT-2, SPT-2W	125
YC-13D	IEC C7	18	SPT-1, SPT-1W, SPT-2, SPT-2W, NISPT-1, NISPT-2, SJT, SVT	125
YC-13C	IEC C7	18	NISPT-1, NISPT-2	125
YC-14L, YC-14L-1, YC-14L-2, YC-14L-3	IEC C5	18	SVT, SJT, SPT-2	15
YC-18	IEC C19	16	SJT, SJTW, SJTO, SJTOW, SJTOOW, SJ, SJO, SJOO, SJOW, SJOOW, ST, STW, STOW, STOOW, S, SO, SOW, SOO, SOOW, SPT-3	125 or 250
		14	SJT, SJTW, SJTO, SJTOW, SJTOOW, SJ, SJO, SJOO, SJOW, SJOOW, ST, STW, STOW, STOOW, S, SO, SOW, SOO, SOOW, SPT-3	125 or 250
		12	SJT, SJTW, SJTO, SJTOW, SJTOOW, SJ, SJO, SJOO, SJOW, SJOOW, ST, STW, STOW, STOOW, S, SO, SOW, SOO, SOOW, SPT-3	125 or 250 V ac
YC-18L	IEC C19	16	SJT, SJTW, SJTO, SJTOW, SJTOOW, SJ, SJO, SJOO, SJOW, SJOOW, ST, STW, STOW, STOOW, S, SO, SOW, SOO, SOOW, SPT-3	125 or 250 V ac
		14	SJT, SJTW, SJTO, SJTOW, SJTOOW, SJ, SJO, SJOO, SJOW, SJOOW, ST, STW, STOW, STOOW, S, SO, SOW, SOO, SOOW,	125 or 250 V ac



# CERTIFICATION RECORD

The company named below has been authorized by CSA to represent the products listed in this record as "CSA Certified" and to affix the CSA Mark to these products according to the terms and conditions of the CSA Service Agreement and applicable CSA program requirements (including additional Markings).

File No: 076393 0 000

Class No: 5842 02 CORD SETS Power Supply Cords

## SUBMITTOR

4554507 Yung Li Company Ltd.  
1F No 10 Lane 235 Pao Chiao Rd  
Hsin Tien City  
Taipei Hsien,  
Taiwan

## FACTORY

4554507 Yung Li Company Ltd.  
1F No 10 Lane 235 Pao Chiao Rd  
Hsin Tien City  
Taipei Hsien,  
Taiwan

October 11, 2001(Replaces:April 23, 2001)

IN COMPLIANCE WITH CSA STD. C22.2 NO 21-95:

- Power supply cords consisting of the following plug caps moulded on flexible cords as indicated:

Cat No Plug Caps	Config- uration	Rating of PSC		AWG	Flexible Cord
		Amp	Volts		Type
YP-11, -11W	1-15P	10	125	18	SPT-1,-2, SVT, SPT-2 non-integral SPT-2, SVT, SPT-2 non-integral
		13	125	16	
YP-12, YP-12L	5-15P	10	125	18	SJT,SVT, SVT(Sh), SPT-2 SJT, SPT-2 SJT
		13	125	16/3	
		15	125	14/3	
YP-12A	5-15P	15	125	14/3	ST
YP-32	2p, 3W(Sp) (Sd)	10	125	18	SJT, SVT, SVT(Sh)

YP-16	6-20P	20	250	12/3	SJT
		18	250	14/3	
YP-17	5-20P	20	125	12/3	SJT
		18	125	14/2	
YP-19	6-15P	15	250	12/3	SJT
				14/3	

Legend: "PSC" Power Supply Cord"(Sp)" Special-use; "(Sd)"Shrouded; "(Sh)" Shielded; in Cat No "W" Polarized.  
 Note: These are Certified only for supply to manufacturers for the assembly, as components, of equipment where the suitability of the combination is determined in the end use.

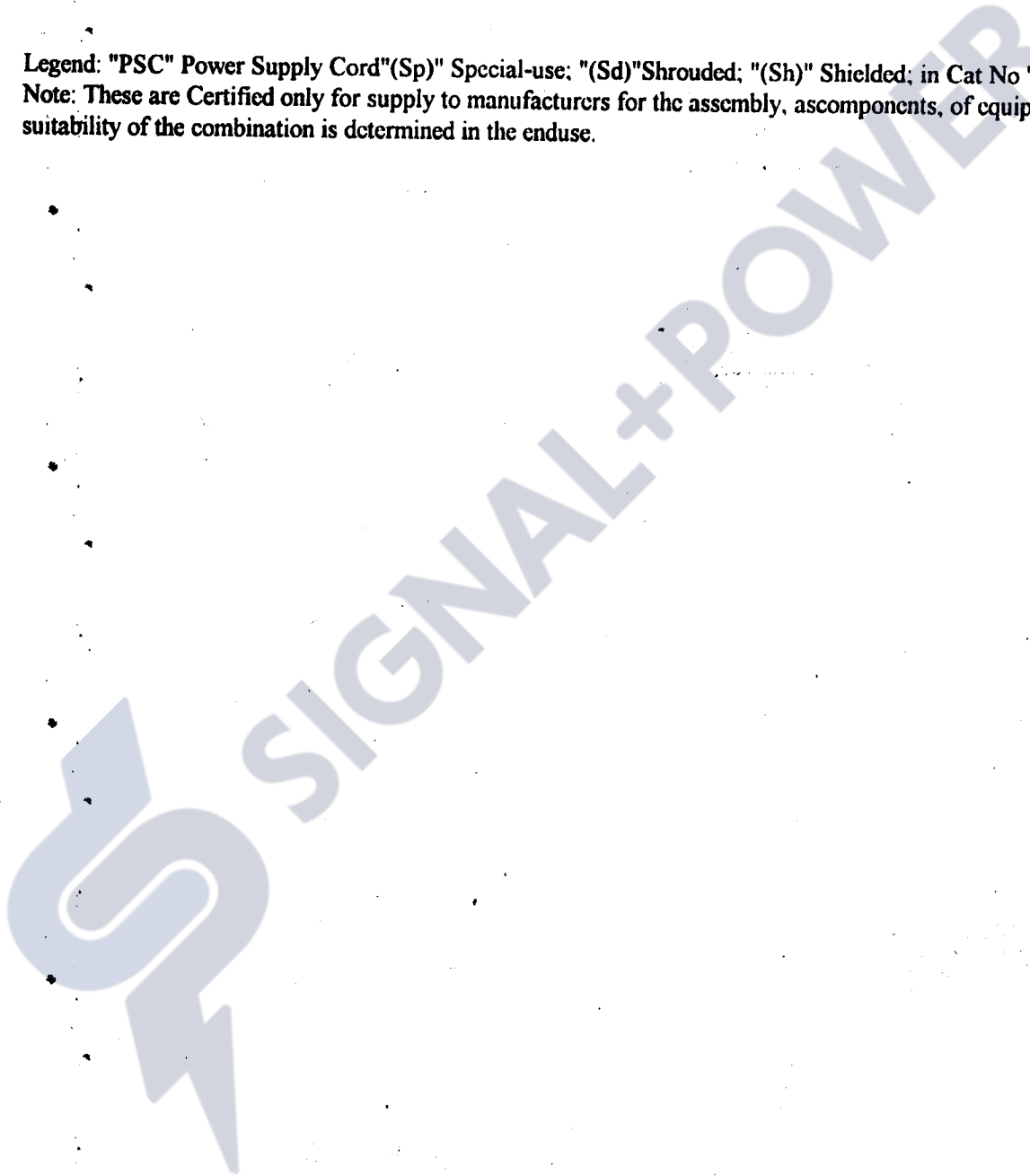

**ZJCZ.E241374  
Flexible Cord**[Page Bottom](#)

---

**Flexible Cord**[See General Information for Flexible Cord](#)**YUNG LI CO LTD**

E241374

1ST FL

10 LANE 235 PAO-CHIAO RD

HSIN-TIEN, TAIPEI HSIEN 231 TAIWAN

**Jacketed cords**, Type SJTW, STW, SJTO, SJTOW, STO, STOW, SJ, S, SJO, SO, SVT, SVTO, SJT, ST, SJOW, SJOOW, SOW, SOOW, SJOO, SOO.

**Parallel cords**, Type SPT-1, SPT-2, SPT-3, SPT-1W, SPT-2W, NISPT-1, NISPT-2.

**Rang and dryer cord**, Type SRDT.

[Last Updated on 2007-02-12](#)

---

[Questions?](#)[Notice of Disclaimer](#)[Page Top](#)[Copyright © 2007 Underwriters Laboratories Inc.®](#)

The appearance of a company's name or product in this database does not in itself assure that products so identified have been manufactured under UL's Follow-Up Service. Only those products bearing the UL Mark should be considered to be Listed and covered under UL's Follow-Up Service. Always look for the Mark on the product.

UL permits the reproduction of the material contained in the Online Certification Directory subject to the following conditions: 1. The Guide Information, Designs and/or Listings (files) must be presented in their entirety and in a non-misleading manner, without any manipulation of the data (or drawings). 2. The statement "Reprinted from the Online Certifications Directory with permission from Underwriters Laboratories Inc." must appear adjacent to the extracted material. In addition, the reprinted material must include a copyright notice in the following format: "Copyright © 2007 Underwriters Laboratories Inc.®"

An independent organization working for a safer world with integrity, precision and knowledge.



# Certificate of Compliance

**Certificate:** 1594794 (LL 76398)

**Master Contract:** 177323

**Project:** 2128031

**Date Issued:** 2009/03/03

**Issued to:** Yung Li Company Ltd.  
1F No 10 Lane 235 Pao Chiao Rd  
Hsin Tien City  
Taipei Hsien,  
Taiwan  
**Attention:** Mr. W.T. Lai

*The products listed below are eligible to bear the CSA Mark shown*



**Issued by:** Kim Nguyen, P. Eng.

**Authorized by:** Nick Alfano, Operations  
Manager

## PRODUCTS

**CLASS 5831 01** - WIRES - Flexible Cord

Types SPT-1, NISPT-1, SPT-2, NISPT-2, SPT-3, SVT, SVTO, SJT, SJTW, SJTO, SJTOW, ST, STW, STO, STOW with PVC insulation and jacket, rated 60C, 75C, 90C and 105C, FT1, FT2, VW-1.

## APPLICABLE REQUIREMENTS

CSA C22.2 No 49 - Flexible Cords and Cables



## Supplement to Certificate of Compliance

Certificate: 1594794

Master Contract: 177323

*The products listed, including the latest revision described below, are eligible to be marked in accordance with the referenced Certificate.*

### Product Certification History

---

Project	Date	Description
2128031	2009/03/03	Adding temperature ratings of 75C and 90C to Types SPT-1,-2,-3, NISPT-1,-2, SVT, SJT, SJTW, ST and STW.
1929621	2007/10/17	Types SJTO, SJTOW, STO, STOW, SVTO added.
1625068	2005/01/10	Addition of Flexible cords Types SJTW, STW rated 60C, 105C
1594794	2004/10/14	Original Certification: Flexible Cords SPT-1, -2, -3, NISPT-1, -2, SVT, SJT, ST

# 東莞永力電業有限公司

YUNG LI CO., LTD

Da Pu Industrial Zone, Gang Zi, Changping Town,  
Dong Guan City, Guangdong 523571 China.P.R.C

TEL:0769-83396797~8

FAX:0769-83396796

E-mail: sales@yung-li.com

Description: YP-16/YC-18

Customer: SIGNAL+POWER

Parts No. : P-1618-15B

Draw No. :

## *REVISION RECORD*

1		
2		
3		
4		
5		

YUNG LI	
CHECKED	PREPARED BY

CUSTOMER	APPROVED



(10') 3050±50

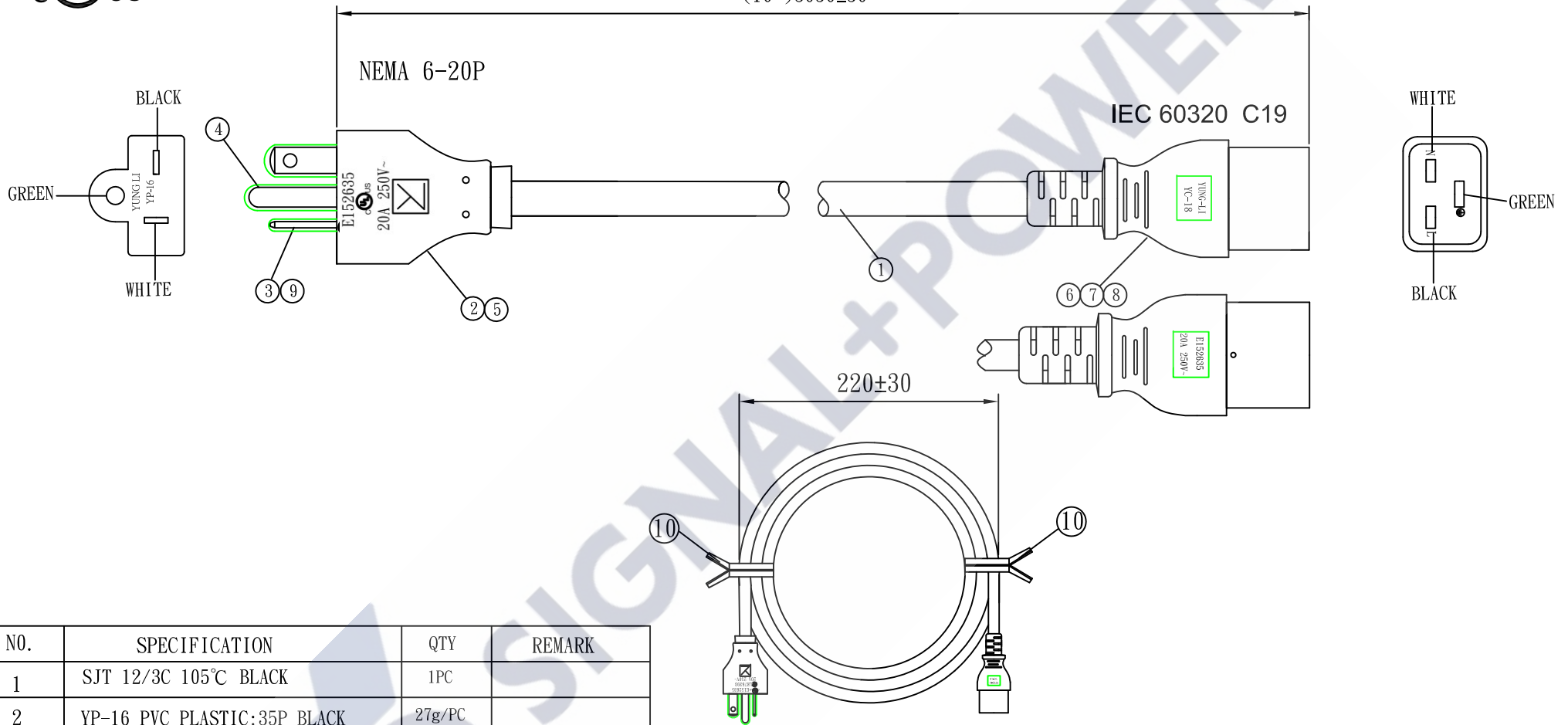

NO.	SPECIFICATION	QTY	REMARK
1	SJT 12/3C 105°C BLACK	1PC	
2	YP-16 PVC PLASTIC:35P BLACK	27g/PC	
3	TER:98695BS-1	2PCS	
4	TER:98473BS-1	1PC	
5	YP-16 INNER BODY	1PC	
6	YC-18 PVC PLASTIC:50P BLACK	25g/PC	
7	YC-18 INNER BODY	1PC	
8	YC-18 TER	3PCS	
9	SLEEVE:3PIN WHITE	1PC	
10	MINI TIE BLACK	2PCS	

TOLERANCE >0±0.30 >1.0±0.50 >10.0±1.0 >20.0±2.0 Angle: ±1°	APPROVED		DATE		<b>SIGNAL+POWER</b>			
	CHECKED		DATE					
	DRAWN		DATE		CUSTOMER			
	TYPE	YP-16/YC-18			P/N	P-1618-10B		
	DRAWING NO.		REV	B	MATERIAL	P. V. C	UNIT	mm
				SCALE				





NEMA 6-20P

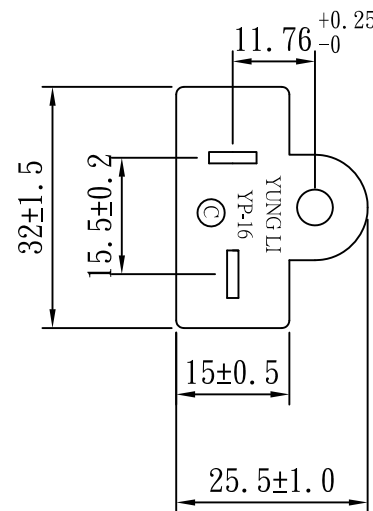
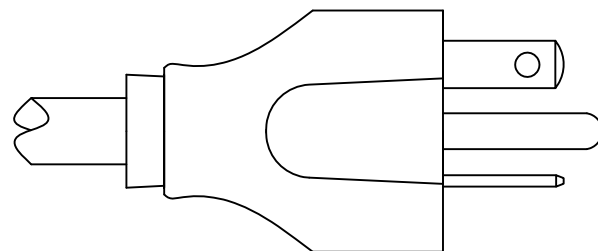
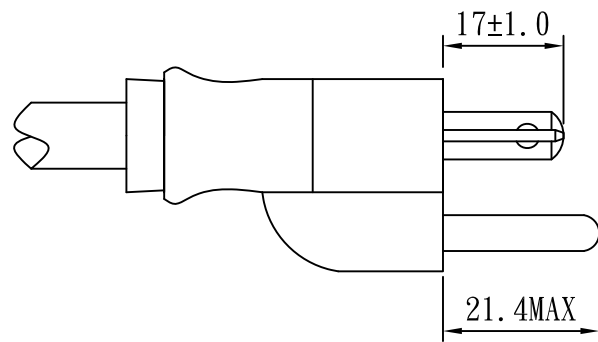
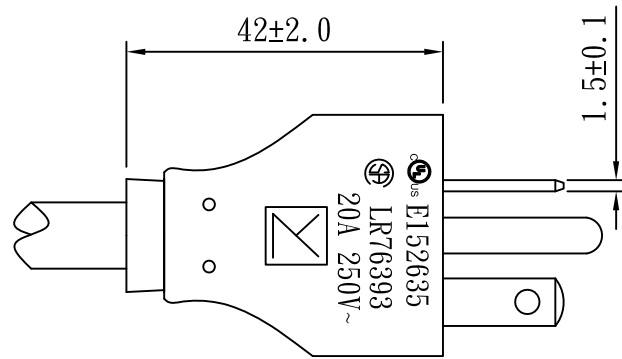

TOLERANCE >0±0.30 >1.0±0.50 >10.0±1.0 >20.0±2.0 Angle: ±1°	APPROVED		DATE		YUNG LI CO., LTD			
	CHECKED		DATE					
	DRAWN		DATE		CUSTOMER			
	TYPE	YP-16			P/N			
	DRAWING NO.	CY-P16U	REV	B	MATERIAL	P. V. C	UNIT	mm
				SCALE	1:1			

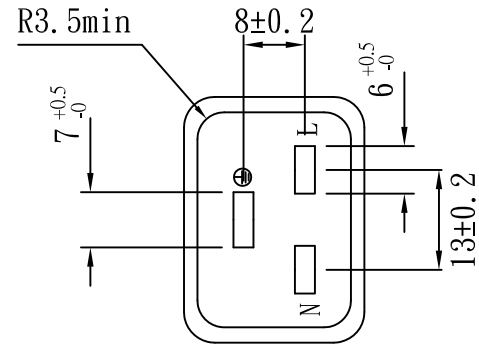
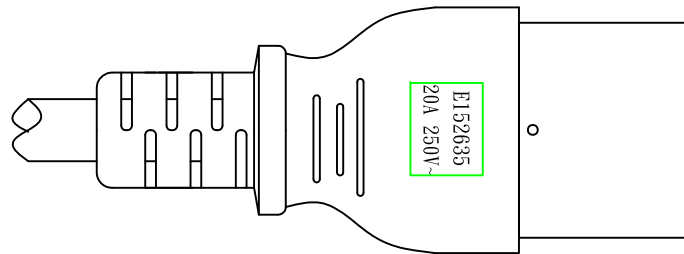
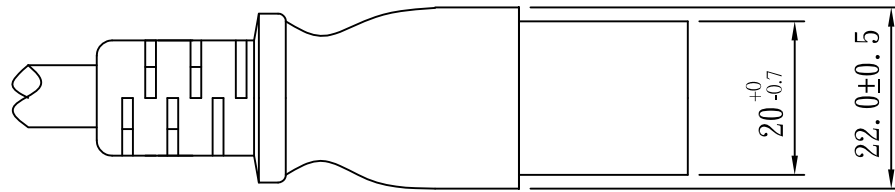
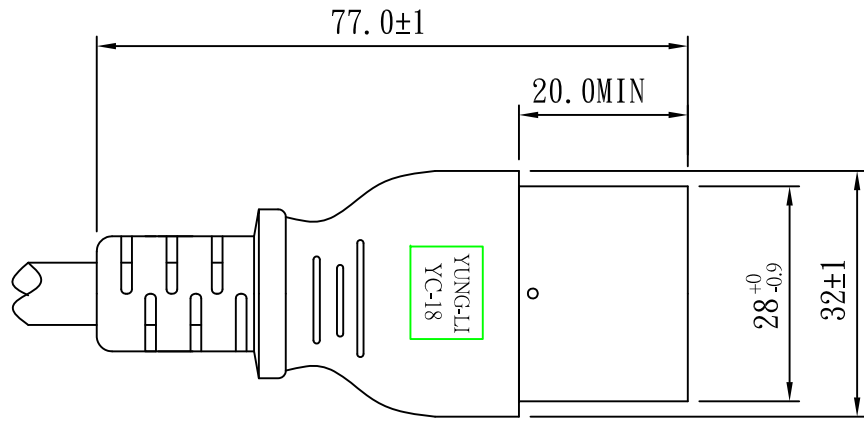

TOLERANCE >0±0.30 >1.0±0.50 >10.0±1.0 >20.0±2.0 Angle: ±1°	APPROVED		DATE	YUNG LI CO., LTD				
	CHECKED		DATE					
	DRAWN		DATE	CUSTOMER				
	TYPE	YC-18			P/N			
	DRAWING NO.	CY-C18U20A250V			MATERIAL	P. V. C	UNIT	mm
				SCALE	1:1			

# YUNG LI CO., LTD

## SPECIFICATION

Yung-Li	Style	PVC FLEXIBLE CORDS	Document No
2009.06.05			
Edition	Size	<b>SJT 12/ 3C 105°C</b>	Page
A			1/2

1. Standard : UL 62 UL 1581

### 2. Construction & Dimension

	Item	Specification
Conductor	Size	12AWG X 3C
	Material	Annealed Bare Copper
	Construction	65/ $\phi$ 0.254 $\pm$ 0.003
Insulation	Material	PVC
	Minimum Average Thickness	0.76mm
	Minimum Thickness at any point	0.69mm
	Diameter	4.0 $\pm$ 0.10
	Identification	Black White Green
Core Assembly	Core Twist	3-Core
	Filler	NA
	Assembly Pair	NA
Taping	Mylar Foil	NA
Shielded	A1-Mylar Foil	NA
Drain Wire	Material	NA
	Construction	NA
Jacket	Material	PVC
	Minimum Average Thickness	1.14mm
	Minimum Thickness at any point	0.91mm
	Overall Diameter(Approx)	11.2 $\pm$ 0.2
	Color	Any Color

### Marking :

YUNG LI (UL) E241374 SJT 3/C 12AWG(3.31mm<sup>2</sup>) 105°C 300V VW-1  
 CSA 177323 SJT 3/C 12AWG(3.31mm<sup>2</sup>) 105°C 300V FT2

# YUNG LI CO., LTD

## SPECIFICATION

Yung-Li	Style	PVC FLEXIBLE CORDS	Document No
2009.06.05			
Edition	Size	<b>SJT 12/ 3C 105°C</b>	Page
A			2/2

3.Electrical & Physical Properties			
Item		Specification	
Rating Voltage		300V	
Insulation Resistance		$\geq 0.76\text{M}\Omega/\text{Km}$ 15.0°C Min	
Dielectric Strength		AC 2.0KV/1 min No Crack	
Spark Test		6.0KV/0.15 Sec	
Insulation	Unaged	Tensile Strength	1500 lbs/in <sup>2</sup> min
		Elongation	100%Min
	Aged	Tensile Strength	Min 85%(136±1°C x168hrs)
		Elongation	Min 65%(136±1°C x168hrs)
Jacket	Unaged	Tensile Strength	1500 lbs/in <sup>2</sup> min
		Elongation	100%Min
	Aged	Tensile Strength	Min 85%(136±1°C x168hrs)
		Elongation	Min 45%(136±1°C x168hrs)
Deformation Test		121±1°C m X 1hr $\leq 50\%$	
Cold Bend Test		-20°C x 4hr No Crack	
Heat Shock Test		121±1°C x 1hr No Crack	

### Graph:

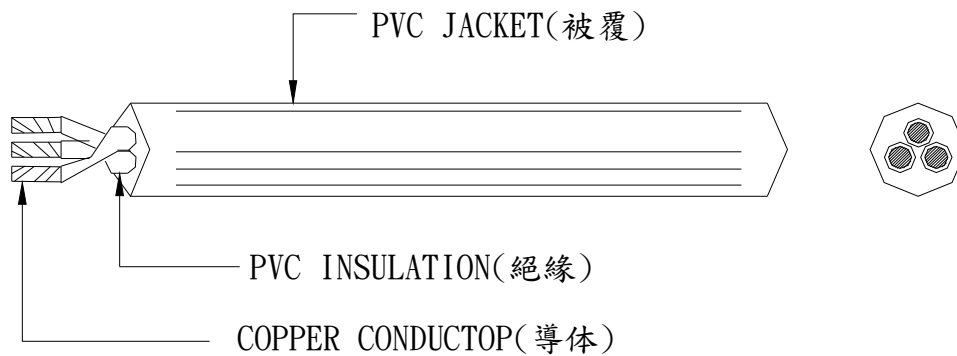

# ELBZ7.E152635 - Cord Sets and Power-supply Cords Certified for Canada

## Cord Sets and Power-supply Cords Certified for Canada

[See General Information for Cord Sets and Power-supply Cords Certified for Canada](#)

### YUNG LI CO LTD

7F-12 NO 99 SEC 1 XINTAI 5TH RD  
XIZHI DISTRICT  
NEW TAIPEI, 22175 TAIWAN

### Power-supply cords

E152635

Cat. No.	ANSI/NEMA WD6 Config	Cord AWG	Cord Type	Electrical Rating Amps V
YP-11	1-15	18/2	SPT-1, SPT-2, SPT-3, NISPT-2, SVT, SVTO, SJT, SJTW, SJTO, SJTOW (All TPE material), SPT-1, SPT-1W, NISPT-1, SPT-2, SPT-2W, NISPT-2, SPT-3, HPN, SVT, SVTO, SJT, SJTW, SJTO, SJTOW, SV, SVO, SJ, SJO, SJOW, SJOOW, EVT, EVJT, EVE, EVJE	7 or 10/125
		17/2	SVT, SVTO (All TPE material), SVT, SVTO, SV, SVO, SJ, SJO, SJOW, SJOOW, EVT, EVJT, EVE, EVJE	12/125
		16/2	SPT-2, SPT-3, NISPT-2, SVT, SVTO, SJT, SJTW, SJTO, SJTOW (All TPE material), SPT-2, SPT-2W, NISPT-2, SPT-3, SVT, SVTO, SJT, SJTW, SJTO, SJTOW, SV, SVO, SJ, SJO, SJOW, SJOOW, EVT, EVJT, EVE, EVJE	13/125
		16/2	HPN	15/125
		14/2	SPT-3, SJT, SJTW, SJTO, SJTOW (All TPE material), SPT-3, SJT, SJTW, SJTO, SJTOW, SJ, SJO, SJOW, SJOOW, EVT, EVJT, EVE, EVJE	15/125
YP-11W	1-15P	18/2	SPT-1, SPT-2, SPT-3, NISPT-2, SVT, SVTO, SJT, SJTW, SJTO, SJTOW (All TPE material), SPT-1, SPT-1W, NISPT-1, SPT-2, SPT-2W, NISPT-2, SPT-3, HPN, SVT, SVTO, SJT, SJTW, , SJTO, SJTOW, SV, SVO, SJ, SJO, SJOW, SJOOW, EVT, EVJT, EVE, EVJE	7 or 10/125
		17/2	SVT, SVTO (All TPE material), SVT, SVTO, SV, SVO, SJ, SJO, SJOW, SJOOW, EVT, EVJT, EVE, EVJE	12/125
		16/2	SPT-2, SPT-3, NISPT-2, SVT, SVTO, SJT, SJTW, SJTO, SJTOW (All TPE material), SPT-2, SPT-2W, NISPT-2, SPT-3, SVT, SVTO, SJT, SJTW, SJTO, SJTOW, SV, SVO, SJ, SJO, SJOW, SJOOW, EVT, EVJT, EVE, EVJE	13/125
		16/2	HPN	15/125
		14/2	SPT-3, SJT, SJTW, SJTO, SJTOW (All TPE material), SPT-3, SJT, SJTW, SJTO, SJTOW, SJ, SJO, SJOW, SJOOW, EVT, EVJT, EVE, EVJE	15/125

		12/3	SJT, SJTW, SJTO, SJTOW, ST, STW, STOW (All TPE material), SJT, SJTW, SJTO, SJTOW, ST, STW, STOW, SO, SOW, SOOW, EVT, EVJT, EVE, EVJE	15/125
YP-12L(A.C.1)	5-15	18/3	NISPT-2 (TPE), NISPT-2, EVT, EVJT, EVE, EVJE	7 or 10/125
		16/3	NISPT-2 (TPE), NISPT-2, EVT, EVJT, EVE, EVJE	13/125
YP-16	6-20	18/3	SVT, SVT Shielded, SVTO, SJT, SJT Shielded, SJTW, SJTW Shielded, SJTO, SJTOW, ST, STW, STOW, SPT-2, SPT-3 (All TPE material), SVT, SVT Shielded, SVTO, SJT, SJT Shielded, SJTW, SJTW Shielded, SJTO, SJTOW, ST, STW, STOW, SV, SVO, SJ, SJO, SJOW, SJOOW, S, SO, SOW, SOOW, SPT-2, SPT-3, EVT, EVJT, EVE, EVJE	2.5 or 10/250
		17/3	SVT, SVTO (All TPE material), SVT, SVTO, SV, SVO, EVT, EVJT	12/250
		16/3	SVT, SVTO, SJT, SJTW, SJTO, SJTOW, ST, STW, STOW, SPT-2, SPT-3 (All TPE material), SVT, SVTO, SJT, SJTW, SJTO, SJTOW, ST, STW, STOW, SV, SVO, SJ, SJO, SJOW, SJOOW, S, SO, SOW, SOOW, SPT-2, SPT-3, EVT, EVJT, EVE, EVJE	13/250
		14/3	SJT, SJTW, SJTO, SJTOW, ST, STW, STOW, SPT-3 (All TPE material), SJT, SJTW, SJTO, SJTOW, ST, STW, STOW, SJ, SJO, SJOW, SJOOW, S, SO, SOW, SOOW, SPT-3, EVT, EVJT, EVE, EVJE	18/250
		12/3	SJT, SJTW, SJTO, SJTOW, ST, STW, STOW, SPT-3 (All TPE material), SJT, SJTW, SJTO, SJTOW, ST, STW, STOW, SJ, SJO, SJOW, SJOOW, S, SO, SOW, SOOW, SPT-3, EVT, EVJT, EVE, EVJE	20/250
YP-16L	6-20	18/3	SJT, SJTW, SJTO, SJTOW, ST, STW, STOW (All TPE material), SJT, SJTW, SJTO, SJTOW, ST, STW, STOW, SO, SOW, SOOW, EVT, EVJT, EVE, EVJE	2.5 or 10/250
		16/3	SJT, SJTW, SJTO, SJTOW, ST, STW, STOW (All TPE material), SJT, SJTW, SJTO, SJTOW, ST, STW, STOW, SO, SOW, SOOW, EVT, EVJT, EVE, EVJE	13/250
		14/3	SJT, SJTW, SJTO, SJTOW, ST, STW, STOW, SPT-3 (All TPE material), SJT, SJTW, SJTO, SJTOW, ST, STW, STOW, SO, SOW, SOOW, SPT-3, EVT, EVJT, EVE, EVJE	18/250
		12/3	SJT, SJTW, SJTO, SJTOW, ST, STW, STOW, SPT-3 (All TPE material), SJT, SJTW, SJTO, SJTOW, ST, STW, STOW, SO, SOW, SOOW, SPT-3, EVT, EVJT, EVE, EVJE	20/250
YP-17	5-20	18/3	SVT, SVT Shielded, SVTO, SJT, SJT Shielded, SJTW, SJTW Shielded, SJTO, SJTOW, ST, STW, STOW, SPT-2, SPT-3 (All TPE material), SVT, SVT Shielded, SVTO, SJT, SJT Shielded, SJTW, SJTW Shielded, SJTO, SJTOW, ST, STW, STOW, SV, SVO, SJ, SJO, SJOW, SJOOW, S, SO, SOW, SOOW, SPT-2, SPT-3, EVT, EVJT, EVE, EVJE	7 or 10/125
		17/3	SVT, SVTO (All TPE material), SVT, SVTO, SV, SVO, EVT, EVJT, EVE, EVJE	12/125
		16/3	SVT, SVTO, SJT, SJTW, SJTO, SJTOW, ST, STW, STOW, SPT-2, SPT-3 (All TPE material), SVT, SVTO, SJT, SJTW, SJTO, SJTOW, ST, STW, STOW, SV, SVO, SJ, SJO, SJOW, SJOOW, S, SO, SOW, SOOW, SPT-2, SPT-3, EVT, EVJT, EVE, EVJE	13/125

		14	SJT, SJTW, SJTO, SJTOW, ST, STW, STOW (Shielded and Non-shielded for all types), SPT-3 (All TPE material), SJT, SJTW, SJTO, SJTOW, ST, STW, STOW, SJ, SJO, SJOO, SJOW, SJOOW, SO, SOO, SOW, SOOW (Shielded or Non-shielded for above types), SPT-3	15/125 or 250
		12	SJT, SJTW, SJTO, SJTOW, ST, STW, STOW (All TPE material, Shielded and Non-shielded for all types), SJT, SJTW, SJTO, SJTOW, ST, STW, STOW, SJ, SJO, SJOO, SJOW, SJOOW, SO, SOO, SOW, SOOW (Shielded or Non-shielded for all types)	15/125 or 250
YC-12(A.C.1)	IEC C13	12	SJT, SJTW, SJTO, SJTOW, ST, STW, STOW, SPT-3 (All TPE material), SJT, SJTW, SJTO, SJTOW, ST, STW, STOW, SO, SOW, SOOW, SPT-3	15/125 or 250
		10	SJT, SJTW, SJTO, SJTOW, ST, STW, STOW (All TPE material), SJT, SJTW, SJTO, SJTOW, ST, STW, STOW, SO, SOW, SOOW	15/125 or 250
YC-12C	IEC C13	18	NISPT-2 (TPE), NISPT-2	2.5, 7 or 10/125 or 250
		16	NISPT-2 (TPE), NISPT-2	13/125 or 250
YC-13	IEC C7	18	SPT-1, SPT-2, NISPT-2, SVT, SJT (All TPE material), SPT-1, SPT-1W, SPT-2, SPT-2W, NISPT-1, NISPT-2, SVT, SJT	2.5/250 or 7/125
YC-13W	IEC C7P	18	SPT-1, SPT-2, NISPT-2, SVT, SJT (All TPE material), SPT-1, SPT-1W, SPT-2, SPT-2W, NISPT-1, NISPT-2, SVT, SJT	2.5/250 or 7/125
YC-14	IEC C5	18	SPT-2, SVT, SVT shielded, SVTO, SJT, SJT shielded, SJTW, SJTW shielded, SJTO, SJTOW (All TPE material), SVT, SVT Shielded, SVTO, SJT, SJT Shielded, SJTW, SJTW Shielded, SJTO, SJTOW, SV, SVO, SJ, SJO, SJOW, SJOOW	2.5/250 or 7/125
			SPT-2	
YC-13L	IEC C7	18	SPT-1, SPT-2, NISPT-2, SVT, SJT (All TPE material), SPT-1, SPT-1W, SPT-2, SPT-2W, NISPT-1, NISPT-2, SVT, SJT	2.5/250 or 7/125
YC-13D	IEC C7	18	SPT-1, SPT-2, NISPT-2, SVT, SJT (All TPE material), SPT-1, SPT-1W, SPT-2, SPT-2W, NISPT-1, NISPT-2, SJT, SVT	2.5/250 or 7/125
YC-13C	IEC C7	18	NISPT-2 (All TPE material), NISPT-1, NISPT-2	2.5/250 or 7/125
YC-13E	IEC C7	18	SPT-1, SPT-2, NISPT-2, SVT, SJT (All TPE material), SPT-1, SPT-1W, SPT-2, SPT-2W, NISPT-1, NISPT-2, SVT, SJT	2.5/250 or 7/125
YC-14L, YC-14L-1, YC-14L-2, YC-14L-3	IEC C5	18	SVT, SJT, SPT-2 (All TPE material), SVT, SJT, SPT-2	2.5/250 or 7/125
YC-18	IEC C19	16	SJT, SJTW, SJTO, SJTOW, SJTOOW, ST, STW, STOW, STOOW, SPT-3 (All TPE material), SJT, SJTW, SJTO, SJTOW, SJTOOW, SJ, SJO, SJOO, SJOW, SJOOW, ST, STW, STOW, STOOW, S, SO, SOW, SOO, SOOW, SPT-3	13/125 or 250

		15	SJT, SJTW, SJTO, SJTOW, SJTOOW, ST, STW, STOW, STOOW, SPT-3 (All TPE material), SJT, SJTW, SJTO, SJTOW, SJTOOW, SJ, SJO, SJOO, SJOW, SJOOW, ST, STW, STOW, STOOW, S, SO, SOW, SOO, SOOW, SPT-3	16/125 or 250
		14	SJT, SJTW, SJTO, SJTOW, SJTOOW, ST, STW, STOW, STOOW, SPT-3 (All TPE material), SJT, SJTW, SJTO, SJTOW, SJTOOW, SJ, SJO, SJOO, SJOW, SJOOW, ST, STW, STOW, STOOW, S, SO, SOW, SOO, SOOW, SPT-3	16/125 or 250
		12	SJT, SJTW, SJTO, SJTOW, SJTOOW, ST, STW, STOW, STOOW, SPT-3 (All TPE material), SJT, SJTW, SJTO, SJTOW, SJTOOW, SJ, SJO, SJOO, SJOW, SJOOW, ST, STW, STOW, STOOW, S, SO, SOW, SOO, SOOW, SPT-3	20/125 or 250 V ac
YC-18L	IEC C19	16	SJT, SJTW, SJTO, SJTOW, SJTOOW, ST, STW, STOW, STOOW, SPT-3 (All TPE material), SJT, SJTW, SJTO, SJTOW, SJTOOW, SJ, SJO, SJOO, SJOW, SJOOW, ST, STW, STOW, STOOW, S, SO, SOW, SOO, SOOW, SPT-3	13/125 or 250 V ac
		15	SJT, SJTW, SJTO, SJTOW, SJTOOW, ST, STW, STOW, STOOW, SPT-3 (All TPE material), SJT, SJTW, SJTO, SJTOW, SJTOOW, SJ, SJO, SJOO, SJOW, SJOOW, ST, STW, STOW, STOOW, S, SO, SOW, SOO, SOOW, SPT-3	250 V ac
		14	SJT, SJTW, SJTO, SJTOW, SJTOOW, ST, STW, STOW, STOOW, SPT-3 (All TPE material), SJT, SJTW, SJTO, SJTOW, SJTOOW, SJ, SJO, SJOO, SJOW, SJOOW, ST, STW, STOW, STOOW, S, SO, SOW, SOO, SOOW, SPT-3	16/125 or 250 V ac
		12	SJT, SJTW, SJTO, SJTOW, SJTOOW, ST, STW, STOW, STOOW, SPT-3 (All TPE material), SJT, SJTW, SJTO, SJTOW, SJTOOW, SJ, SJO, SJOO, SJOW, SJOOW, ST, STW, STOW, STOOW, S, SO, SOW, SOO, SOOW, SPT-3	20/125 or 250 V ac
YC-20	IEC C15	18	SVT, SJT, SJTW, SJTO, SJTOW, ST, STW, STOW, SPT-3 (All TPE material), SVT, SJT, SJTW, SJTO, SJTOW, ST, STW, STOW, SO, SOW, SOOW, SPT-3	2.5, 7 or 10/125 or 250
		17	SVT, SJT, SJTW, SJTO, SJTOW, ST, STW, STOW, SPT-3 (All TPE material), SVT, SJT, SJTW, SJTO, SJTOW, ST, STW, STOW, SO, SOW, SOOW, SPT-3	12/125 or 250
		16	SJT, SJTW, SJTO, SJTOW, ST, STW, STOW, SPT-3 (All TPE material), SJT, SJTW, SJTO, SJTOW, ST, STW, STOW, SO, SOW, SOOW, SPT-3	13/125 or 250
		15	SJT, SJTW, SJTO, SJTOW, ST, STW, STOW, SPT-3 (All TPE material), SJT, SJTW, SJTO, SJTOW, ST, STW, STOW, SO, SOW, SOOW, SPT-3	14/125 or 250
		14	SJT, SJTW, SJTO, SJTOW, ST, STW, STOW, SPT-3 (All TPE material), SJT, SJTW, SJTO, SJTOW, ST, STW, STOW, SO, SOW, SOOW	15/125 or 250
YC-25	IEC C21	16	SJT, SJTW, SJTO, SJTOW, SJTOOW, ST, STW, STOW, STOOW, SPT-3 (All TPE material), SJT, SJTW, SJTO, SJTOW, SJTOOW, SJ, SJO, SJOO, SJOW, SJOOW, ST, STW, STOW, STOOW, S, SO, SOW, SOO, SOOW, SPT-3	13/125 or 250
		15	SJT, SJTW, SJTO, SJTOW, SJTOOW, ST, STW, STOW, STOOW, SPT-3 (All TPE material), SJT, SJTW, SJTO, SJTOW, SJTOOW, SJ, SJO, SJOO, SJOW, SJOOW, ST, STW, STOW, STOOW, S, SO, SOW, SOO, SOOW, SPT-3	16/125 or 250
		14	SJT, SJTW, SJTO, SJTOW, SJTOOW, ST, STW, STOW, STOOW, SPT-3 (All TPE material), SJT, SJTW, SJTO, SJTOW, SJTOOW, SJ, SJO, SJOO, SJOW, SJOOW, ST, STW, STOW, STOOW, S, SO, SOW, SOO, SOOW, SPT-3	16/125 or 250
		12	SJT, SJTW, SJTO, SJTOW, SJTOOW, ST, STW, STOW, STOOW, SPT-3 (All TPE material), SJT, SJTW, SJTO, SJTOW, SJTOOW, SJ, SJO, SJOO, SJOW, SJOOW, ST, STW, STOW, STOOW, S, SO, SOW, SOO, SOOW, SPT-3	20/125 or 250
YC-25L	IEC C21	16	SJT, SJTW, SJTO, SJTOW, SJTOOW, ST, STW, STOW, STOOW, SPT-3 (All TPE material), SJT, SJTW, SJTO, SJTOW, SJTOOW, SJ, SJO, SJOO, SJOW, SJOOW, ST, STW, STOW, STOOW, S, SO, SOW, SOO, SOOW, SPT-3	13/125 or 250 V ac



# Certificate of Compliance

**Certificate:** 1868157 (LR 76393-10)

**Master Contract:** 177323

**Project:** 70057585

**Date Issued:** 2016-04-20

**Issued to:** Yung Li Company Ltd.  
1F No 10 Lane 235 Pao Chiao Rd  
Hsin Tien City  
Taipei Hsien,  
TAIWAN

**Attention:** Mr. W. T. Lai

*The products listed below are eligible to bear the CSA Mark shown*



*Vivian Zhao*

**Issued by:** Vivian Zhao

## **PRODUCTS**

CLASS - C584202 - CORD SETS-Power Supply Cords

Power supply cord(s) consisting of the following plug caps moulded onto flexible cords as listed:

Cat No.	Plug Cap			Flexible Cord	
	Rating	Configuration	AWG	Temp(°C)	Type
YP-16	20A, 250V	6-20P	12/3	60, 75, 90, 105	SPT-3, SJT, SJTO, SJTOW, ST, STW, STOW, SO, SOW, SOOW S, SJ, SJO, SJOW, SJOOW
	18A, 250V	6-20P	14/3		
	10A, 250V	6-20P	18/3		
YP-17	20A, 125V	5-20P	12/3	60, 75, 90, 105	
	18A, 125V	5-20P	14/3		
YP-19	15A, 250V	6-15P	12/3	60, 75, 90, 105	
	15A, 250V	6-15P	14/3		

**Note:** These are sold to manufacturers for the assembly as components of Certified electrical equipment where the suitability of the combination is determined by CSA International.

**APPLICABLE REQUIREMENTS**

- CSA C22.2 No. 21 - Cord Sets and Power Supply Cords
- CSA C22.2 No. 42 - General Use Receptacles, Attachment Plugs and Similar Wiring Devices
- INFORMS Cord Sets No.7A - Production-Line Test for Cord Sets and Power-Supply Cords

## *Supplement to Certificate of Compliance*

**Certificate:** 1868157(LR 76393-10)

**Master Contract:** 177323

*The products listed, including the latest revision described below,  
are eligible to be marked in accordance with the referenced Certificate.*

### **Product Certification History**

---

<b>Project</b>	<b>Date</b>	<b>Description</b>
70057585	2016-04-20	Update report 1868157 to comply with C22.2 No.21-14.
1868157	2007-03-19	Power Supply Cord consisting of the attachment plug cap, Cat No YP-16, YP-17 and YP-19. (Supersedes Report LR 76393-10 and includes alternative PVC compounds.)

**ZJCZ.E241374**  
**Flexible Cord**[Page Bottom](#)

---

**Flexible Cord**[See General Information for Flexible Cord](#)**YUNG LI CO LTD**

E241374

7F-12 NO 99 SEC 1 XINTAI 5TH RD  
XIZHI DISTRICT  
NEW TAIPEI, 22175 TAIWAN**Decorative cord**, Type(s) SPT-1W, SPT-2W**Dryer and range cord**, Type(s) SRDT**Jacketed cord**, Type(s) S, SE, SE-HF, SJ, SJE, SJE-HF, SJO, SJO, SJOOW, SJOW, SJT, SJT-B, SJTO, SJTOW, SJTW, SO, SOO, SOOW, SOW, ST, ST-B, STO, STOW, STW, SVE, SVE-HF, SVT, SVT-B, SVTO**Parallel cord**, Type(s) NISPE-1, NISPE-1-HF, NISPE-2, NISPE-2-HF, NISPT-1, NISPT-2, SPE-1, SPE-1-HF, SPE-2, SPE-2-HF, SPE-3, SPE-3-HF, SPT-1, SPT-2, SPT-3[Last Updated](#) on 2016-03-07

---

[Questions?](#)[Print this page](#)[Terms of Use](#)[Page Top](#)

◆ 2016 UL LLC

The appearance of a company's name or product in this database does not in itself assure that products so identified have been manufactured under UL's Follow-Up Service. Only those products bearing the UL Mark should be considered to be Certified and covered under UL's Follow-Up Service. Always look for the Mark on the product.

UL permits the reproduction of the material contained in the Online Certification Directory subject to the following conditions: 1. The Guide Information, Assemblies, Constructions, Designs, Systems, and/or Certifications (files) must be presented in their entirety and in a non-misleading manner, without any manipulation of the data (or drawings). 2. The statement "Reprinted from the Online Certifications Directory with permission from UL" must appear adjacent to the extracted material. In addition, the reprinted material must include a copyright notice in the following format: "© 2016 UL LLC".



# Certificate of Compliance

**Certificate:** 1594794 (LL 76398)

**Master Contract:** 177323

**Project:** 2616524

**Date Issued:** April 3, 2013

**Issued to:** Yung Li Company Ltd.

1F No 10 Lane 235 Pao Chiao Rd  
Hsin Tien City  
Taipei Hsien,  
Taiwan  
Attention: Wendy Wu

*The products listed below are eligible to bear the CSA Mark shown*



*Kim Nguyen*

**Issued by:** Kim Nguyen, P. Eng.

## **PRODUCTS**

**CLASS 5831 01** - WIRES - Flexible Cord

Types SPT-1, NISPT-1, SPT-2, NISPT-2, SPT-3, SVT, SVTO, SJT, SJTW, SJTO, SJTOW, ST, STW, STO, STOW with PVC insulation and jacket, rated 60C, 75C, 90C and 105C, FT1, FT2, VW-1.

## **APPLICABLE REQUIREMENTS**

CSA C22.2 No 49 - Flexible Cords and Cables

# 東莞永力電業有限公司

YUNG LI CO., LTD

Da Pu Industrial Zone, Gang Zi, Changping Town,  
Dong Guan City, Guangdong 523571 China.P.R.C

TEL:0769-83396797~8

FAX:0769-83396796

E-mail: sales@yung-li.com

Description: YP-16/YC-18

Customer: SIGNAL+POWER

Parts No. : P-1618-15B

Draw No. :

## *REVISION RECORD*

1		
2		
3		
4		
5		

YUNG LI	
CHECKED	PREPARED BY

CUSTOMER	APPROVED

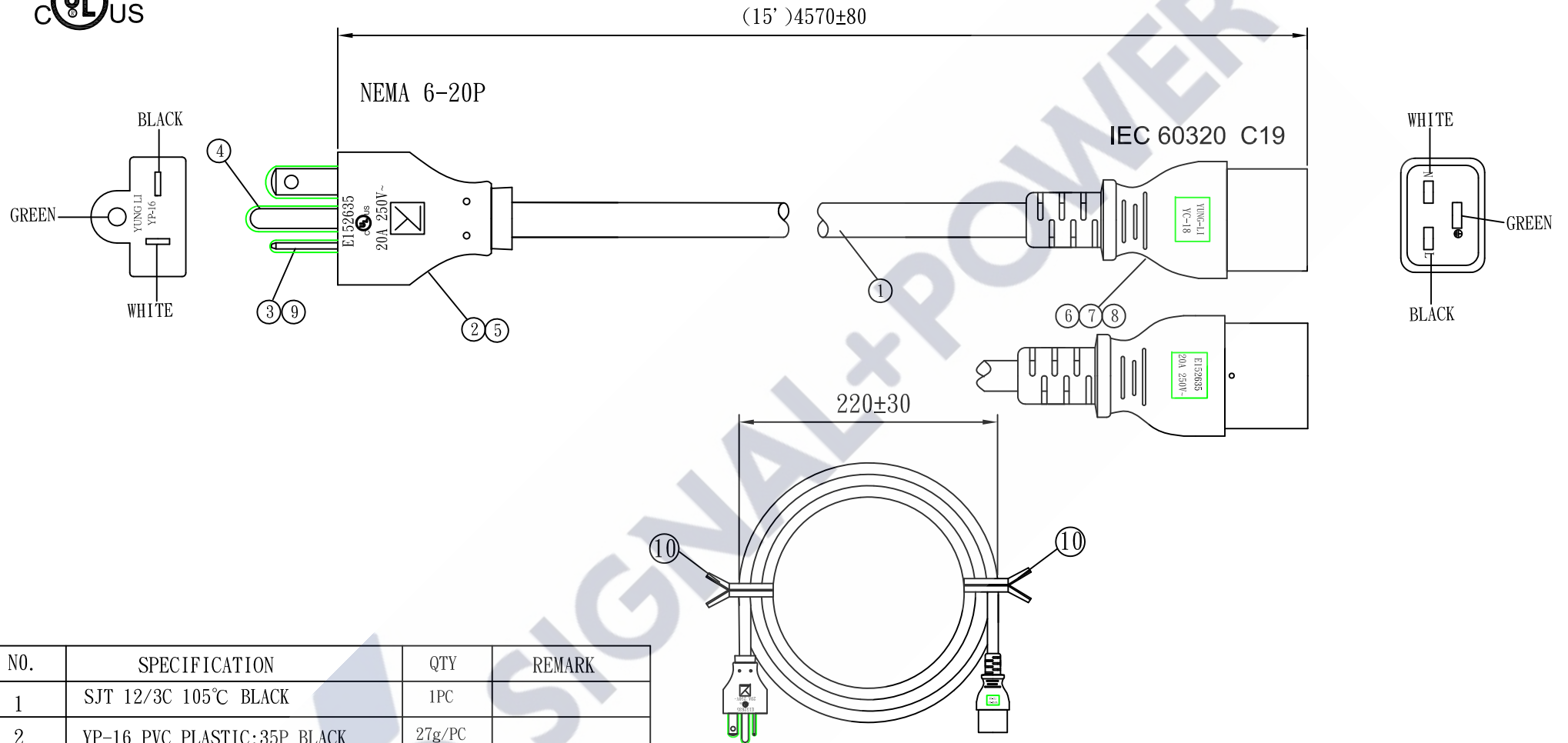

NO.	SPECIFICATION	QTY	REMARK
1	SJT 12/3C 105°C BLACK	1PC	
2	YP-16 PVC PLASTIC:35P BLACK	27g/PC	
3	TER:98695BS-1	2PCS	
4	TER:98473BS-1	1PC	
5	YP-16 INNER BODY	1PC	
6	YC-18 PVC PLASTIC:50P BLACK	25g/PC	
7	YC-18 INNER BODY	1PC	
8	YC-18 TER	3PCS	
9	SLEEVE:3PIN WHITE	1PC	
10	MINI TIE BLACK	2PCS	

TOLERANCE >0±0.30 >1.0±0.50 >10.0±1.0 >20.0±2.0 Angle: ±1°	APPROVED		DATE		<b>SIGNAL+POWER</b>			
	CHECKED		DATE					
	DRAWN	SUKI	DATE	22.09.20	CUSTOMER			
	TYPE	YP-16/YC-18			P/N	P-1618-15B		
	DRAWING NO.	CY-U2051-02	REV	B	MATERIAL	P. V. C	UNIT	mm
				SCALE				



NEMA 6-20P

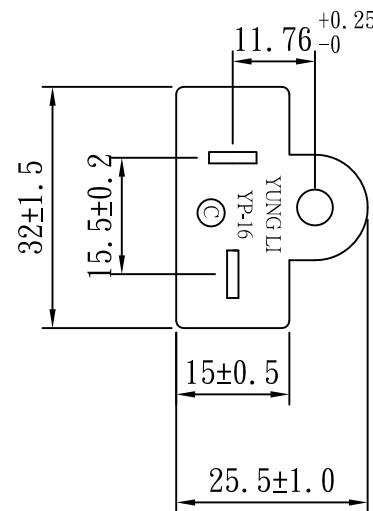
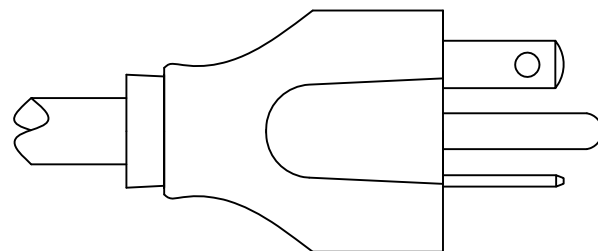
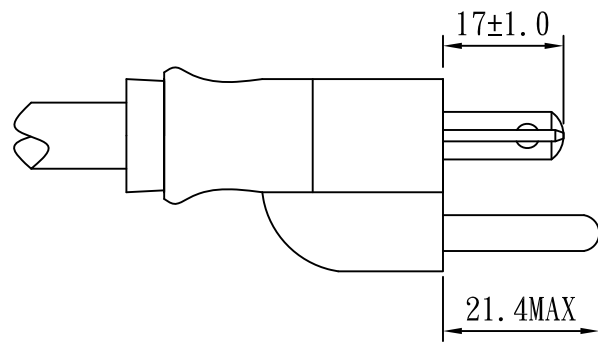
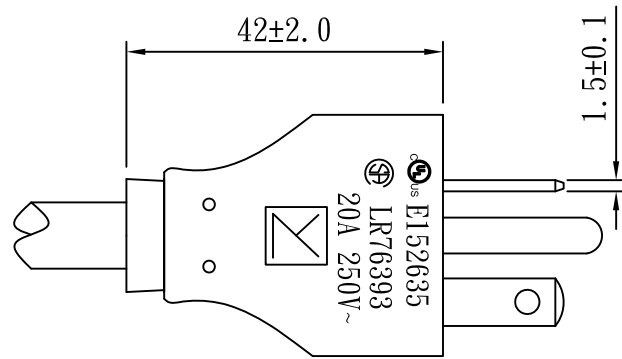

TOLERANCE >0±0.30 >1.0±0.50 >10.0±1.0 >20.0±2.0 Angle: ±1°	APPROVED		DATE		YUNG LI CO., LTD			
	CHECKED		DATE					
	DRAWN		DATE		CUSTOMER			
	TYPE	YP-16			P/N			
	DRAWING NO.	CY-P16U	REV	B	MATERIAL	P. V. C	UNIT	mm
				SCALE	1:1			



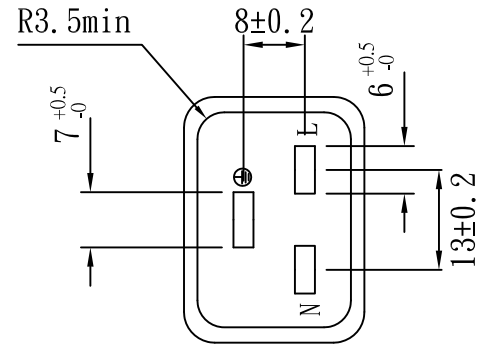
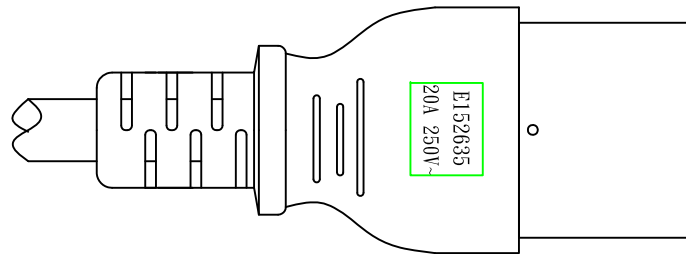
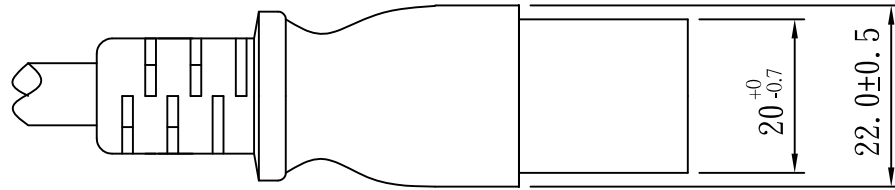
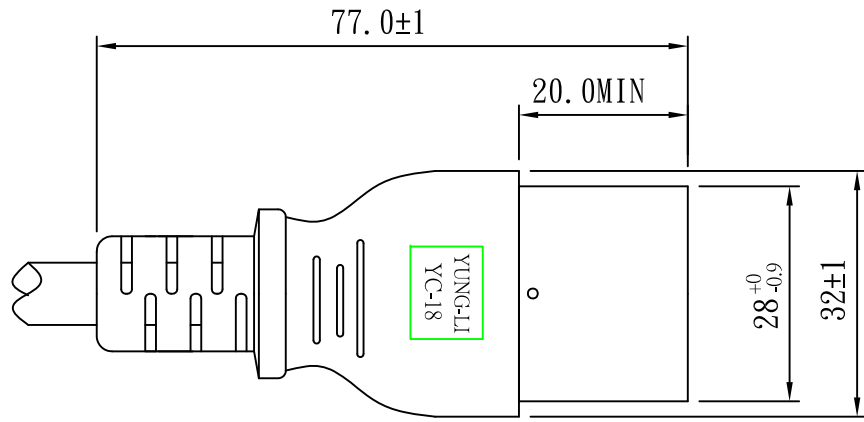

TOLERANCE >0±0.30 >1.0±0.50 >10.0±1.0 >20.0±2.0 Angle: ±1°	APPROVED		DATE		YUNG LI CO., LTD			
	CHECKED		DATE					
	DRAWN		DATE		CUSTOMER			
	TYPE	YC-18			P/N			
	DRAWING NO.	CY-C18U20A250V			MATERIAL	P. V. C	UNIT	mm
				SCALE	1:1			

# YUNG LI CO., LTD

## SPECIFICATION

Yung-Li	Style	PVC FLEXIBLE CORDS	Document No
2009.06.05			
Edition	Size	<b>SJT 12/ 3C 105°C</b>	Page
A			1/2

1. Standard : UL 62 UL 1581

### 2. Construction & Dimension

	Item	Specification
Conductor	Size	12AWG X 3C
	Material	Annealed Bare Copper
	Construction	65/ $\phi$ 0.254 $\pm$ 0.003
Insulation	Material	PVC
	Minimum Average Thickness	0.76mm
	Minimum Thickness at any point	0.69mm
	Diameter	4.0 $\pm$ 0.10
	Identification	Black White Green
Core Assembly	Core Twist	3-Core
	Filler	NA
	Assembly Pair	NA
Taping	Mylar Foil	NA
Shielded	A1-Mylar Foil	NA
Drain Wire	Material	NA
	Construction	NA
Jacket	Material	PVC
	Minimum Average Thickness	1.14mm
	Minimum Thickness at any point	0.91mm
	Overall Diameter(Approx)	11.2 $\pm$ 0.2
	Color	Any Color

### Marking :

YUNG LI (UL) E241374 SJT 3/C 12AWG(3.31mm<sup>2</sup>) 105°C 300V VW-1  
 CSA 177323 SJT 3/C 12AWG(3.31mm<sup>2</sup>) 105°C 300V FT2

# YUNG LI CO., LTD

## SPECIFICATION

Yung-Li	Style	PVC FLEXIBLE CORDS	Document No
2009.06.05			
Edition	Size	<b>SJT 12/ 3C 105°C</b>	Page
A			2/2

3.Electrical & Physical Properties			
Item		Specification	
Rating Voltage		300V	
Insulation Resistance		$\geq 0.76\text{M}\Omega/\text{Km}$ 15.0°C Min	
Dielectric Strength		AC 2.0KV/1 min No Crack	
Spark Test		6.0KV/0.15 Sec	
Insulation	Unaged	Tensile Strength	1500 lbs/in <sup>2</sup> min
		Elongation	100%Min
	Aged	Tensile Strength	Min 85%(136±1°C x168hrs)
		Elongation	Min 65%(136±1°C x168hrs)
Jacket	Unaged	Tensile Strength	1500 lbs/in <sup>2</sup> min
		Elongation	100%Min
	Aged	Tensile Strength	Min 85%(136±1°C x168hrs)
		Elongation	Min 45%(136±1°C x168hrs)
Deformation Test		121±1°C m X 1hr $\leq 50\%$	
Cold Bend Test		-20°C x 4hr No Crack	
Heat Shock Test		121±1°C x 1hr No Crack	

### Graph:

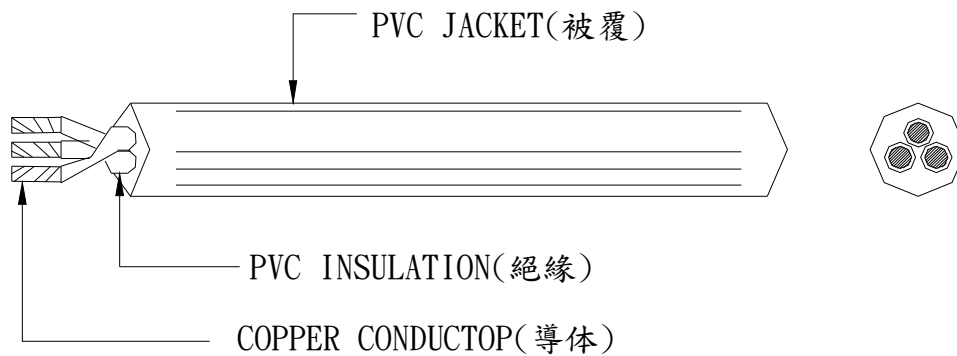

# ELBZ7.E152635 - Cord Sets and Power-supply Cords Certified for Canada

## Cord Sets and Power-supply Cords Certified for Canada

[See General Information for Cord Sets and Power-supply Cords Certified for Canada](#)

### YUNG LI CO LTD

7F-12 NO 99 SEC 1 XINTAI 5TH RD  
XIZHI DISTRICT  
NEW TAIPEI, 22175 TAIWAN

### Power-supply cords

E152635

Cat. No.	ANSI/NEMA WD6 Config	Cord AWG	Cord Type	Electrical Rating Amps V
YP-11	1-15	18/2	SPT-1, SPT-2, SPT-3, NISPT-2, SVT, SVTO, SJT, SJTW, SJTO, SJTOW (All TPE material), SPT-1, SPT-1W, NISPT-1, SPT-2, SPT-2W, NISPT-2, SPT-3, HPN, SVT, SVTO, SJT, SJTW, SJTO, SJTOW, SV, SVO, SJ, SJO, SJOW, SJOOW, EVT, EVJT, EVE, EVJE	7 or 10/125
		17/2	SVT, SVTO (All TPE material), SVT, SVTO, SV, SVO, SJ, SJO, SJOW, SJOOW, EVT, EVJT, EVE, EVJE	12/125
		16/2	SPT-2, SPT-3, NISPT-2, SVT, SVTO, SJT, SJTW, SJTO, SJTOW (All TPE material), SPT-2, SPT-2W, NISPT-2, SPT-3, SVT, SVTO, SJT, SJTW, SJTO, SJTOW, SV, SVO, SJ, SJO, SJOW, SJOOW, EVT, EVJT, EVE, EVJE	13/125
		16/2	HPN	15/125
		14/2	SPT-3, SJT, SJTW, SJTO, SJTOW (All TPE material), SPT-3, SJT, SJTW, SJTO, SJTOW, SJ, SJO, SJOW, SJOOW, EVT, EVJT, EVE, EVJE	15/125
YP-11W	1-15P	18/2	SPT-1, SPT-2, SPT-3, NISPT-2, SVT, SVTO, SJT, SJTW, SJTO, SJTOW (All TPE material), SPT-1, SPT-1W, NISPT-1, SPT-2, SPT-2W, NISPT-2, SPT-3, HPN, SVT, SVTO, SJT, SJTW, , SJTO, SJTOW, SV, SVO, SJ, SJO, SJOW, SJOOW, EVT, EVJT, EVE, EVJE	7 or 10/125
		17/2	SVT, SVTO (All TPE material), SVT, SVTO, SV, SVO, SJ, SJO, SJOW, SJOOW, EVT, EVJT, EVE, EVJE	12/125
		16/2	SPT-2, SPT-3, NISPT-2, SVT, SVTO, SJT, SJTW, SJTO, SJTOW (All TPE material), SPT-2, SPT-2W, NISPT-2, SPT-3, SVT, SVTO, SJT, SJTW, SJTO, SJTOW, SV, SVO, SJ, SJO, SJOW, SJOOW, EVT, EVJT, EVE, EVJE	13/125
		16/2	HPN	15/125
		14/2	SPT-3, SJT, SJTW, SJTO, SJTOW (All TPE material), SPT-3, SJT, SJTW, SJTO, SJTOW, SJ, SJO, SJOW, SJOOW, EVT, EVJT, EVE, EVJE	15/125

		12/3	SJT, SJTW, SJTO, SJTOW, ST, STW, STOW (All TPE material), SJT, SJTW, SJTO, SJTOW, ST, STW, STOW, SO, SOW, SOOW, EVT, EVJT, EVE, EVJE	15/125
YP-12L(A.C.1)	5-15	18/3	NISPT-2 (TPE), NISPT-2, EVT, EVJT, EVE, EVJE	7 or 10/125
		16/3	NISPT-2 (TPE), NISPT-2, EVT, EVJT, EVE, EVJE	13/125
YP-16	6-20	18/3	SVT, SVT Shielded, SVTO, SJT, SJT Shielded, SJTW, SJTW Shielded, SJTO, SJTOW, ST, STW, STOW, SPT-2, SPT-3 (All TPE material), SVT, SVT Shielded, SVTO, SJT, SJT Shielded, SJTW, SJTW Shielded, SJTO, SJTOW, ST, STW, STOW, SV, SVO, SJ, SJO, SJOW, SJOOW, S, SO, SOW, SOOW, SPT-2, SPT-3, EVT, EVJT, EVE, EVJE	2.5 or 10/250
		17/3	SVT, SVTO (All TPE material), SVT, SVTO, SV, SVO, EVT, EVJT	12/250
		16/3	SVT, SVTO, SJT, SJTW, SJTO, SJTOW, ST, STW, STOW, SPT-2, SPT-3 (All TPE material), SVT, SVTO, SJT, SJTW, SJTO, SJTOW, ST, STW, STOW, SV, SVO, SJ, SJO, SJOW, SJOOW, S, SO, SOW, SOOW, SPT-2, SPT-3, EVT, EVJT, EVE, EVJE	13/250
		14/3	SJT, SJTW, SJTO, SJTOW, ST, STW, STOW, SPT-3 (All TPE material), SJT, SJTW, SJTO, SJTOW, ST, STW, STOW, SJ, SJO, SJOW, SJOOW, S, SO, SOW, SOOW, SPT-3, EVT, EVJT, EVE, EVJE	18/250
		12/3	SJT, SJTW, SJTO, SJTOW, ST, STW, STOW, SPT-3 (All TPE material), SJT, SJTW, SJTO, SJTOW, ST, STW, STOW, SJ, SJO, SJOW, SJOOW, S, SO, SOW, SOOW, SPT-3, EVT, EVJT, EVE, EVJE	20/250
YP-16L	6-20	18/3	SJT, SJTW, SJTO, SJTOW, ST, STW, STOW (All TPE material), SJT, SJTW, SJTO, SJTOW, ST, STW, STOW, SO, SOW, SOOW, EVT, EVJT, EVE, EVJE	2.5 or 10/250
		16/3	SJT, SJTW, SJTO, SJTOW, ST, STW, STOW (All TPE material), SJT, SJTW, SJTO, SJTOW, ST, STW, STOW, SO, SOW, SOOW, EVT, EVJT, EVE, EVJE	13/250
		14/3	SJT, SJTW, SJTO, SJTOW, ST, STW, STOW, SPT-3 (All TPE material), SJT, SJTW, SJTO, SJTOW, ST, STW, STOW, SO, SOW, SOOW, SPT-3, EVT, EVJT, EVE, EVJE	18/250
		12/3	SJT, SJTW, SJTO, SJTOW, ST, STW, STOW, SPT-3 (All TPE material), SJT, SJTW, SJTO, SJTOW, ST, STW, STOW, SO, SOW, SOOW, SPT-3, EVT, EVJT, EVE, EVJE	20/250
YP-17	5-20	18/3	SVT, SVT Shielded, SVTO, SJT, SJT Shielded, SJTW, SJTW Shielded, SJTO, SJTOW, ST, STW, STOW, SPT-2, SPT-3 (All TPE material), SVT, SVT Shielded, SVTO, SJT, SJT Shielded, SJTW, SJTW Shielded, SJTO, SJTOW, ST, STW, STOW, SV, SVO, SJ, SJO, SJOW, SJOOW, S, SO, SOW, SOOW, SPT-2, SPT-3, EVT, EVJT, EVE, EVJE	7 or 10/125
		17/3	SVT, SVTO (All TPE material), SVT, SVTO, SV, SVO, EVT, EVJT, EVE, EVJE	12/125
		16/3	SVT, SVTO, SJT, SJTW, SJTO, SJTOW, ST, STW, STOW, SPT-2, SPT-3 (All TPE material), SVT, SVTO, SJT, SJTW, SJTO, SJTOW, ST, STW, STOW, SV, SVO, SJ, SJO, SJOW, SJOOW, S, SO, SOW, SOOW, SPT-2, SPT-3, EVT, EVJT, EVE, EVJE	13/125

		14	SJT, SJTW, SJTO, SJTOW, ST, STW, STOW (Shielded and Non-shielded for all types), SPT-3 (All TPE material), SJT, SJTW, SJTO, SJTOW, ST, STW, STOW, SJ, SJO, SJOO, SJOW, SJOOW, SO, SOO, SOW, SOOW (Shielded or Non-shielded for above types), SPT-3	15/125 or 250
		12	SJT, SJTW, SJTO, SJTOW, ST, STW, STOW (All TPE material, Shielded and Non-shielded for all types), SJT, SJTW, SJTO, SJTOW, ST, STW, STOW, SJ, SJO, SJOO, SJOW, SJOOW, SO, SOO, SOW, SOOW (Shielded or Non-shielded for all types)	15/125 or 250
YC-12(A.C.1)	IEC C13	12	SJT, SJTW, SJTO, SJTOW, ST, STW, STOW, SPT-3 (All TPE material), SJT, SJTW, SJTO, SJTOW, ST, STW, STOW, SO, SOW, SOOW, SPT-3	15/125 or 250
		10	SJT, SJTW, SJTO, SJTOW, ST, STW, STOW (All TPE material), SJT, SJTW, SJTO, SJTOW, ST, STW, STOW, SO, SOW, SOOW	15/125 or 250
YC-12C	IEC C13	18	NISPT-2 (TPE), NISPT-2	2.5, 7 or 10/125 or 250
		16	NISPT-2 (TPE), NISPT-2	13/125 or 250
YC-13	IEC C7	18	SPT-1, SPT-2, NISPT-2, SVT, SJT (All TPE material), SPT-1, SPT-1W, SPT-2, SPT-2W, NISPT-1, NISPT-2, SVT, SJT	2.5/250 or 7/125
YC-13W	IEC C7P	18	SPT-1, SPT-2, NISPT-2, SVT, SJT (All TPE material), SPT-1, SPT-1W, SPT-2, SPT-2W, NISPT-1, NISPT-2, SVT, SJT	2.5/250 or 7/125
YC-14	IEC C5	18	SPT-2, SVT, SVT shielded, SVTO, SJT, SJT shielded, SJTW, SJTW shielded, SJTO, SJTOW (All TPE material), SVT, SVT Shielded, SVTO, SJT, SJT Shielded, SJTW, SJTW Shielded, SJTO, SJTOW, SV, SVO, SJ, SJO, SJOW, SJOOW	2.5/250 or 7/125
			SPT-2	
YC-13L	IEC C7	18	SPT-1, SPT-2, NISPT-2, SVT, SJT (All TPE material), SPT-1, SPT-1W, SPT-2, SPT-2W, NISPT-1, NISPT-2, SVT, SJT	2.5/250 or 7/125
YC-13D	IEC C7	18	SPT-1, SPT-2, NISPT-2, SVT, SJT (All TPE material), SPT-1, SPT-1W, SPT-2, SPT-2W, NISPT-1, NISPT-2, SJT, SVT	2.5/250 or 7/125
YC-13C	IEC C7	18	NISPT-2 (All TPE material), NISPT-1, NISPT-2	2.5/250 or 7/125
YC-13E	IEC C7	18	SPT-1, SPT-2, NISPT-2, SVT, SJT (All TPE material), SPT-1, SPT-1W, SPT-2, SPT-2W, NISPT-1, NISPT-2, SVT, SJT	2.5/250 or 7/125
YC-14L, YC-14L-1, YC-14L-2, YC-14L-3	IEC C5	18	SVT, SJT, SPT-2 (All TPE material), SVT, SJT, SPT-2	2.5/250 or 7/125
YC-18	IEC C19	16	SJT, SJTW, SJTO, SJTOW, SJTOOW, ST, STW, STOW, STOOW, SPT-3 (All TPE material), SJT, SJTW, SJTO, SJTOW, SJTOOW, SJ, SJO, SJOO, SJOW, SJOOW, ST, STW, STOW, STOOW, S, SO, SOW, SOO, SOOW, SPT-3	13/125 or 250

		15	SJT, SJTW, SJTO, SJTOW, SJTOOW, ST, STW, STOW, STOOW, SPT-3 (All TPE material), SJT, SJTW, SJTO, SJTOW, SJTOOW, SJ, SJO, SJOO, SJOW, SJOOW, ST, STW, STOW, STOOW, S, SO, SOW, SOO, SOOW, SPT-3	16/125 or 250
		14	SJT, SJTW, SJTO, SJTOW, SJTOOW, ST, STW, STOW, STOOW, SPT-3 (All TPE material), SJT, SJTW, SJTO, SJTOW, SJTOOW, SJ, SJO, SJOO, SJOW, SJOOW, ST, STW, STOW, STOOW, S, SO, SOW, SOO, SOOW, SPT-3	16/125 or 250
		12	SJT, SJTW, SJTO, SJTOW, SJTOOW, ST, STW, STOW, STOOW, SPT-3 (All TPE material), SJT, SJTW, SJTO, SJTOW, SJTOOW, SJ, SJO, SJOO, SJOW, SJOOW, ST, STW, STOW, STOOW, S, SO, SOW, SOO, SOOW, SPT-3	20/125 or 250 V ac
YC-18L	IEC C19	16	SJT, SJTW, SJTO, SJTOW, SJTOOW, ST, STW, STOW, STOOW, SPT-3 (All TPE material), SJT, SJTW, SJTO, SJTOW, SJTOOW, SJ, SJO, SJOO, SJOW, SJOOW, ST, STW, STOW, STOOW, S, SO, SOW, SOO, SOOW, SPT-3	13/125 or 250 V ac
		15	SJT, SJTW, SJTO, SJTOW, SJTOOW, ST, STW, STOW, STOOW, SPT-3 (All TPE material), SJT, SJTW, SJTO, SJTOW, SJTOOW, SJ, SJO, SJOO, SJOW, SJOOW, ST, STW, STOW, STOOW, S, SO, SOW, SOO, SOOW, SPT-3	250 V ac
		14	SJT, SJTW, SJTO, SJTOW, SJTOOW, ST, STW, STOW, STOOW, SPT-3 (All TPE material), SJT, SJTW, SJTO, SJTOW, SJTOOW, SJ, SJO, SJOO, SJOW, SJOOW, ST, STW, STOW, STOOW, S, SO, SOW, SOO, SOOW, SPT-3	16/125 or 250 V ac
		12	SJT, SJTW, SJTO, SJTOW, SJTOOW, ST, STW, STOW, STOOW, SPT-3 (All TPE material), SJT, SJTW, SJTO, SJTOW, SJTOOW, SJ, SJO, SJOO, SJOW, SJOOW, ST, STW, STOW, STOOW, S, SO, SOW, SOO, SOOW, SPT-3	20/125 or 250 V ac
YC-20	IEC C15	18	SVT, SJT, SJTW, SJTO, SJTOW, ST, STW, STOW, SPT-3 (All TPE material), SVT, SJT, SJTW, SJTO, SJTOW, ST, STW, STOW, SO, SOW, SOOW, SPT-3	2.5, 7 or 10/125 or 250
		17	SVT, SJT, SJTW, SJTO, SJTOW, ST, STW, STOW, SPT-3 (All TPE material), SVT, SJT, SJTW, SJTO, SJTOW, ST, STW, STOW, SO, SOW, SOOW, SPT-3	12/125 or 250
		16	SJT, SJTW, SJTO, SJTOW, ST, STW, STOW, SPT-3 (All TPE material), SJT, SJTW, SJTO, SJTOW, ST, STW, STOW, SO, SOW, SOOW, SPT-3	13/125 or 250
		15	SJT, SJTW, SJTO, SJTOW, ST, STW, STOW, SPT-3 (All TPE material), SJT, SJTW, SJTO, SJTOW, ST, STW, STOW, SO, SOW, SOOW, SPT-3	14/125 or 250
		14	SJT, SJTW, SJTO, SJTOW, ST, STW, STOW, SPT-3 (All TPE material), SJT, SJTW, SJTO, SJTOW, ST, STW, STOW, SO, SOW, SOOW	15/125 or 250
YC-25	IEC C21	16	SJT, SJTW, SJTO, SJTOW, SJTOOW, ST, STW, STOW, STOOW, SPT-3 (All TPE material), SJT, SJTW, SJTO, SJTOW, SJTOOW, SJ, SJO, SJOO, SJOW, SJOOW, ST, STW, STOW, STOOW, S, SO, SOW, SOO, SOOW, SPT-3	13/125 or 250
		15	SJT, SJTW, SJTO, SJTOW, SJTOOW, ST, STW, STOW, STOOW, SPT-3 (All TPE material), SJT, SJTW, SJTO, SJTOW, SJTOOW, SJ, SJO, SJOO, SJOW, SJOOW, ST, STW, STOW, STOOW, S, SO, SOW, SOO, SOOW, SPT-3	16/125 or 250
		14	SJT, SJTW, SJTO, SJTOW, SJTOOW, ST, STW, STOW, STOOW, SPT-3 (All TPE material), SJT, SJTW, SJTO, SJTOW, SJTOOW, SJ, SJO, SJOO, SJOW, SJOOW, ST, STW, STOW, STOOW, S, SO, SOW, SOO, SOOW, SPT-3	16/125 or 250
		12	SJT, SJTW, SJTO, SJTOW, SJTOOW, ST, STW, STOW, STOOW, SPT-3 (All TPE material), SJT, SJTW, SJTO, SJTOW, SJTOOW, SJ, SJO, SJOO, SJOW, SJOOW, ST, STW, STOW, STOOW, S, SO, SOW, SOO, SOOW, SPT-3	20/125 or 250
YC-25L	IEC C21	16	SJT, SJTW, SJTO, SJTOW, SJTOOW, ST, STW, STOW, STOOW, SPT-3 (All TPE material), SJT, SJTW, SJTO, SJTOW, SJTOOW, SJ, SJO, SJOO, SJOW, SJOOW, ST, STW, STOW, STOOW, S, SO, SOW, SOO, SOOW, SPT-3	13/125 or 250 V ac

# Certificate of Compliance

**Certificate:** 1868157 (LR 76393-10)

**Master Contract:** 177323

**Project:** 70057585

**Date Issued:** 2016-04-20

**Issued to:** Yung Li Company Ltd.  
1F No 10 Lane 235 Pao Chiao Rd  
Hsin Tien City  
Taipei Hsien,  
TAIWAN

**Attention:** Mr. W. T. Lai

*The products listed below are eligible to bear the CSA Mark shown*



*Vivian Zhao*

**Issued by:** Vivian Zhao

## **PRODUCTS**

CLASS - C584202 - CORD SETS-Power Supply Cords

Power supply cord(s) consisting of the following plug caps moulded onto flexible cords as listed:

Cat No.	Plug Cap			Flexible Cord	
	Rating	Configuration	AWG	Temp(°C)	Type
YP-16	20A, 250V	6-20P	12/3	60, 75, 90, 105	SPT-3, SJT, SJTO, SJTOW, ST, STW, STOW, SO, SOW, SOOW S, SJ, SJO, SJOW, SJOOW
	18A, 250V	6-20P	14/3		
	10A, 250V	6-20P	18/3		
YP-17	20A, 125V	5-20P	12/3	60, 75, 90, 105	
	18A, 125V	5-20P	14/3		
YP-19	15A, 250V	6-15P	12/3	60, 75, 90, 105	
	15A, 250V	6-15P	14/3		

**Note:** These are sold to manufacturers for the assembly as components of Certified electrical equipment where the suitability of the combination is determined by CSA International.



**APPLICABLE REQUIREMENTS**

- CSA C22.2 No. 21 - Cord Sets and Power Supply Cords
- CSA C22.2 No. 42 - General Use Receptacles, Attachment Plugs and Similar Wiring Devices
- INFORMS Cord Sets No.7A - Production-Line Test for Cord Sets and Power-Supply Cords

## *Supplement to Certificate of Compliance*

**Certificate:** 1868157(LR 76393-10)

**Master Contract:** 177323

*The products listed, including the latest revision described below,  
are eligible to be marked in accordance with the referenced Certificate.*

### **Product Certification History**

---

<b>Project</b>	<b>Date</b>	<b>Description</b>
70057585	2016-04-20	Update report 1868157 to comply with C22.2 No.21-14.
1868157	2007-03-19	Power Supply Cord consisting of the attachment plug cap, Cat No YP-16, YP-17 and YP-19. (Supersedes Report LR 76393-10 and includes alternative PVC compounds.)

**ZJCZ.E241374**  
**Flexible Cord**[Page Bottom](#)

---

**Flexible Cord**[See General Information for Flexible Cord](#)**YUNG LI CO LTD**

E241374

7F-12 NO 99 SEC 1 XINTAI 5TH RD  
XIZHI DISTRICT  
NEW TAIPEI, 22175 TAIWAN**Decorative cord**, Type(s) SPT-1W, SPT-2W**Dryer and range cord**, Type(s) SRDT**Jacketed cord**, Type(s) S, SE, SE-HF, SJ, SJE, SJE-HF, SJO, SJO, SJOOW, SJOW, SJT, SJT-B, SJTO, SJTOW, SJTW, SO, SOO, SOOW, SOW, ST, ST-B, STO, STOW, STW, SVE, SVE-HF, SVT, SVT-B, SVTO**Parallel cord**, Type(s) NISPE-1, NISPE-1-HF, NISPE-2, NISPE-2-HF, NISPT-1, NISPT-2, SPE-1, SPE-1-HF, SPE-2, SPE-2-HF, SPE-3, SPE-3-HF, SPT-1, SPT-2, SPT-3[Last Updated](#) on 2016-03-07

---

[Questions?](#)[Print this page](#)[Terms of Use](#)[Page Top](#)

◆ 2016 UL LLC

The appearance of a company's name or product in this database does not in itself assure that products so identified have been manufactured under UL's Follow-Up Service. Only those products bearing the UL Mark should be considered to be Certified and covered under UL's Follow-Up Service. Always look for the Mark on the product.

UL permits the reproduction of the material contained in the Online Certification Directory subject to the following conditions: 1. The Guide Information, Assemblies, Constructions, Designs, Systems, and/or Certifications (files) must be presented in their entirety and in a non-misleading manner, without any manipulation of the data (or drawings). 2. The statement "Reprinted from the Online Certifications Directory with permission from UL" must appear adjacent to the extracted material. In addition, the reprinted material must include a copyright notice in the following format: "© 2016 UL LLC".



# Certificate of Compliance

**Certificate:** 1594794 (LL 76398)

**Master Contract:** 177323

**Project:** 2616524

**Date Issued:** April 3, 2013

**Issued to:** Yung Li Company Ltd.

1F No 10 Lane 235 Pao Chiao Rd  
Hsin Tien City  
Taipei Hsien,  
Taiwan  
Attention: Wendy Wu

*The products listed below are eligible to bear the CSA Mark shown*



*Kim Nguyen*

**Issued by:** Kim Nguyen, P. Eng.

## **PRODUCTS**

**CLASS 5831 01** - WIRES - Flexible Cord

Types SPT-1, NISPT-1, SPT-2, NISPT-2, SPT-3, SVT, SVTO, SJT, SJTW, SJTO, SJTOW, ST, STW, STO, STOW with PVC insulation and jacket, rated 60C, 75C, 90C and 105C, FT1, FT2, VW-1.

## **APPLICABLE REQUIREMENTS**

CSA C22.2 No 49 - Flexible Cords and Cables