

東莞永力電業有限公司

YUNG LI CO., LTD

Da Pu Industrial Zone, Gang Zi, Changping Town,
Dong Guan City, Guangdong 523571 China.P.R.C

TEL:0769-83396797~8

FAX:0769-83396796

E-mail: sales@yung-li.com

Description: YP-32/YC-20

Customer: SIGNAL+POWER

Parts No. : GPC-3220-XXYYY

Draw No. :

REVISION RECORD

1		
2		
3		
4		
5		

YUNG LI	
CHECKED	PREPARED BY

CUSTOMER	APPROVED

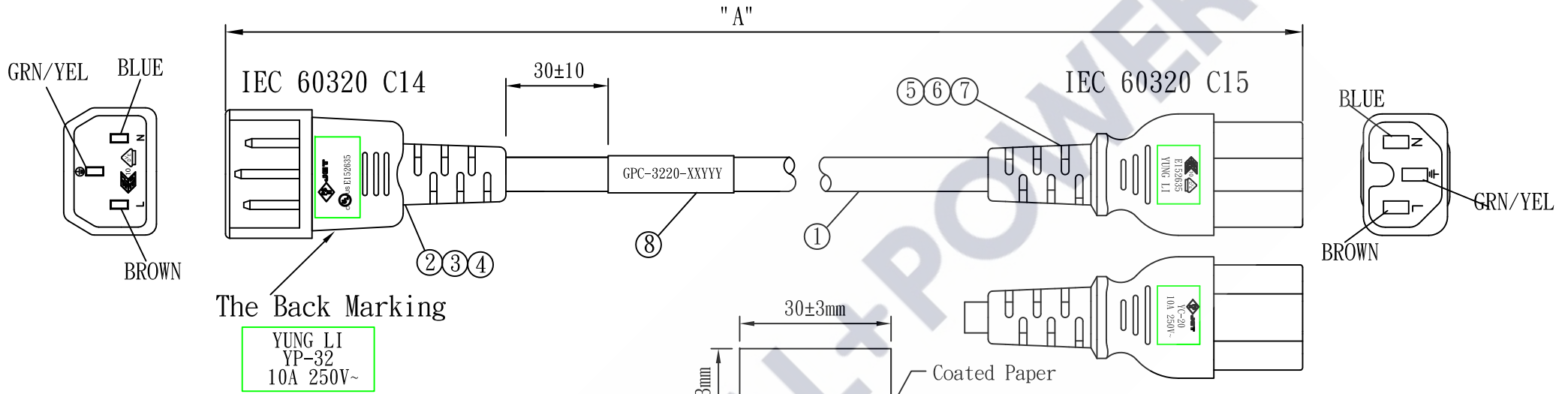

LENGTH: "A"	3FT	6FT
	915±30	1830±50
P/N BLACK	GPC-3220-03BLK	GPC-3220-06BLK
P/N WHITE(RAL9010)	GPC-3220-03WHT	GPC-3220-06WHT
P/N RED(GY-49)	GPC-3220-03RED	GPC-3220-06RED
P/N BLUE(PT293C)	GPC-3220-03BLU	GPC-3220-06BLU

Packing: Bundled to ease installation.

Sample drawing NO.: SP210510-07

MARKING:

Yung Li Co., Ltd. H05V2V2-F 3G 1.0mm² <VDE> 300/500V SAA-191358-EA c(UL)us E241374
SJT 3/C 17AWG(1.04mm²) 105°C 300V VW-1 <PS>E JET HVCTF 3X1.0mm² ㄗㄩㄥㄌㄧ -F-

NO.	SPECIFICATION	QTY	REMARK
1	PSE HVCTF 1.0/3C+H05V2V2-F 1.0/3C+SJT 17/3C 105°C	1PC	
2	YP-32 PVC PLASTIC:50P	15g/PC	
3	TER:98672BS-1	3PCS	
4	INNER BODY: 2X4	1PC	
5	TER:97740	3PCS	
6	YC-20 INNER BODY	1PC	
7	YC-20 PVC PLASTIC:50P	18g/PC	
8	LABEL:(40+25)*30mm	1PC	

Tolerance >0±0.30 >1.0±0.50 >10.0±1.0 >20.0±2.0 Angle: ±1°	Approved	Date	SIGNAL+POWER			
	Checked	Date	Customer			
Drawn	5.105	Date	P.N.		GPC-3220-XXYYY	
Cat. No.	YP-32/YC-20		Material	P.V.C	Unit	mm
Drawing No.	Rev.	B	Scale			

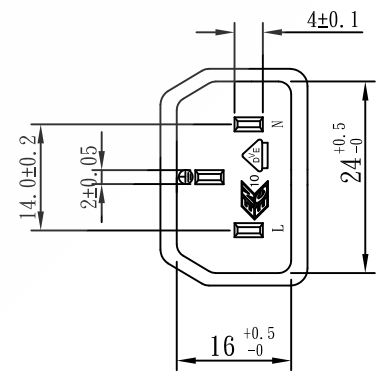
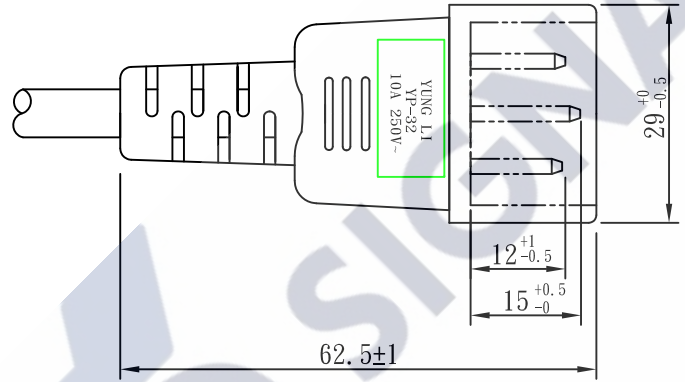
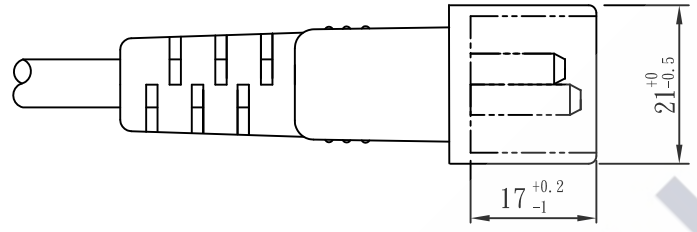
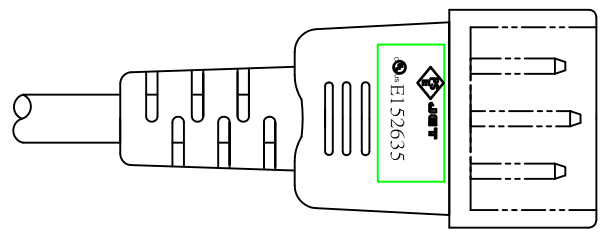

TOLERANCE >0±0.30 >1.0±0.50 >10.0±1.0 >20.0±2.0 Angle: ±1°	APPROVED		DATE		YUNG LI CO., LTD			
	CHECKED		DATE					
	DRAWN		DATE		CUSTOMER			
	TYPE	YP-32			P/N			
	DRAWING NO.		REV	B	MATERIAL	P. V. C	UNIT	mm
				SCALE	1:1			



IEC 60320 C15

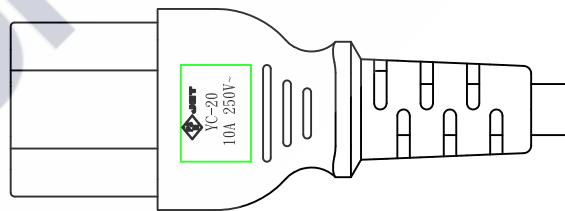
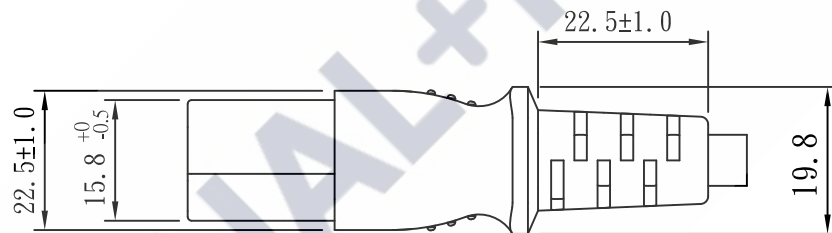
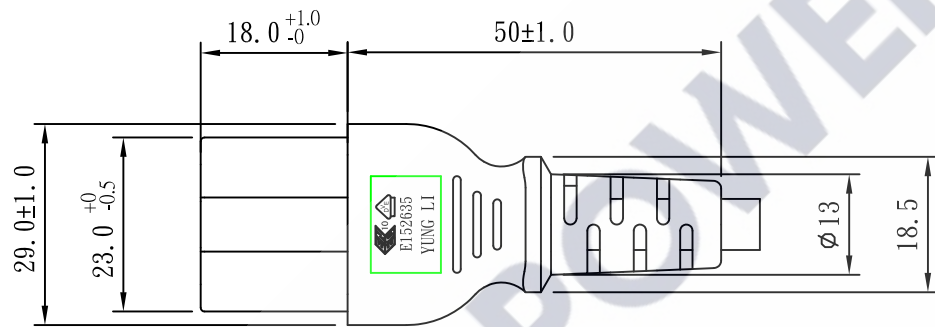
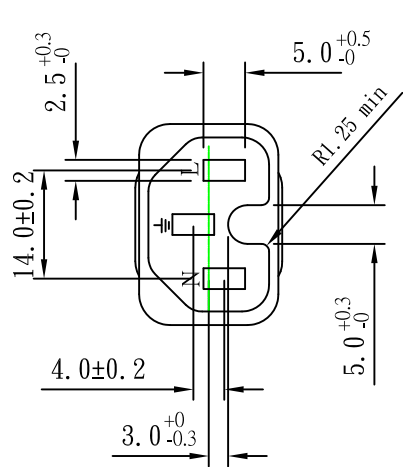

TOLERANCE >0±0.30 >1.0±0.50 >10.0±1.0 >20.0±2.0 Angle: ±1°	APPROVED		DATE		YUNG LI CO., LTD.			
	CHECKED		DATE					
	DRAWN		DATE		CUSTOMER			
	TYPE	YC-20			P/N			
	DRAWING NO.		REV	B	MATERIAL	P. V. C	UNIT	mm
				SCALE	1:1			

YUNG LI CO., LTD

SPECIFICATION

Yung-Li	Style	PVC FLEXIBLE CORDS	Document No
2020.05.04			
Edition	Size	H05V2V2-F 3x1.0 / SJT 17X3C/ HVCTF 3x1.0	Page
A			1/2

1. Standard: IEC 60227 IEC 60228 & UL 62 UL 1581 & JIS C3306

2. Construction & Dimension

	Item	Specification
Conductor	Size	17AWG
	Material	Annealed Bare Copper
	Construction	32/ ϕ 0.2±0.005
Insulation	Material	PVC
	Minimum Average Thickness	0.76mm
	Minimum Thickness at any point	0.69mm
	Diameter	2.90 ± 0.10
	Identification	Blue,Brown,Yellow/Green
Core Assembly	Core Twist	3-Core
	Filler	NA
	Assembly Pair	NA
Taping	Mylar Foil	NA
Shielded	A1-Mylar Foil	NA
Drain Wire	Material	NA
	Construction	NA
Jacket	Material	NA
	Minimum Average Thickness	0.9mm
	Minimum Thickness at any point	0.7mm
	Overall Diameter(Approx)	8.0± 0.15
	Color	Any Color

MARKING:

Yung Li Co., Ltd. H05V2V2-F 3G 1.0mm² <VDE> 300/500V SAA-191358-EA c(UL)us E241374
 SJT 3/C 17AWG(1.04mm²) 105°C 300V VW-1 <PS>E JET HVCTF 3X1.0mm² クイネツ -F-

YUNG LI CO., LTD SPECIFICATION

Yung-Li	Style	PVC FLEXIBLE CORDS	Document No
2020.05.04			
Edition	Size	H05V2V2-F 3x1.0 / SJT 17X3C/ HVCTF 3x1.0	Page
A			2/2

3. Electrical & Physical Properties			
Item		Specification	
Rating Voltage		300V	
Maximum Temperature Rating		105°C	
Conductor resistance(AT 20°C)		19.1 Ω/Km MAX	
Insulation Resistance(AT 70°C)		0.010MΩ/Km Min	
Dielectric Strength		AC 2.0 KV / 15 min No Break	
Spark Test		5.0KV	
Insulation	Unaged	Tensile Strength	1.02 kgf/mm ² min
		Elongation	150% Min
	Aged	Tensile Strength	Min 85%(136±1°C x168hrs)
		Elongation	Min 65%(136±1°C x168hrs)
Jacket	Unaged	Tensile Strength	1.02 kgf/mm ² min
		Elongation	150% Min
	Aged	Tensile Strength	Min 85%(136±1°C x168hrs)
		Elongation	Min 45%(136±1°C x168hrs)
Deformation Test		70±4°C X 1hr ≤ 50%	
Cold Bend Test		-20°C x 4hr No Crack	
Heat Shock Test		150±2°C x 1hr No Crack	

Graph:

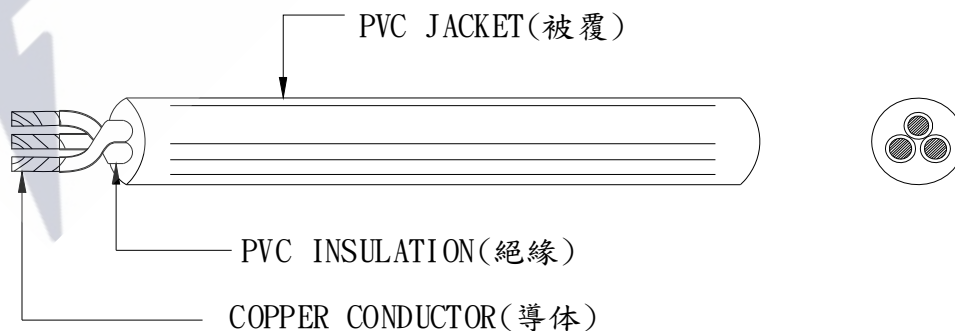

ELBZ7.E152635 - Cord Sets and Power-supply Cords Certified for Canada

Cord Sets and Power-supply Cords Certified for Canada

See General Information for Cord Sets and Power-supply Cords Certified for Canada

YUNG LI CO LTD

7F-12 NO 99 SEC 1 XINTAI 5TH RD
XIZHI DISTRICT
NEW TAIPEI, 22175 TAIWAN

Power-supply cords

E152635

Cat. No.	ANSI/NEMA WD6 Config	Cord AWG	Cord Type	Electrical Rating Amps V
YP-11	1-15	18/2	SPT-1, SPT-2, SPT-3, NISPT-2, SVT, SVTO, SJT, SJTW, SJTO, SJTOW (All TPE material), SPT-1, SPT-1W, NISPT-1, SPT-2, SPT-2W, NISPT-2, SPT-3, HPN, SVT, SVTO, SJT, SJTW, SJTO, SJTOW, SV, SVO, SJ, SJO, SJOW, SJOOW, EVT, EVJT, EVE, EVJE	7 or 10/125
		17/2	SVT, SVTO (All TPE material), SVT, SVTO, SV, SVO, SJ, SJO, SJOW, SJOOW, EVT, EVJT, EVE, EVJE	12/125
		16/2	SPT-2, SPT-3, NISPT-2, SVT, SVTO, SJT, SJTW, SJTO, SJTOW (All TPE material), SPT-2, SPT-2W, NISPT-2, SPT-3, SVT, SVTO, SJT, SJTW, SJTO, SJTOW, SV, SVO, SJ, SJO, SJOW, SJOOW, EVT, EVJT, EVE, EVJE	13/125
		16/2	HPN	15/125
		14/2	SPT-3, SJT, SJTW, SJTO, SJTOW (All TPE material), SPT-3, SJT, SJTW, SJTO, SJTOW, SJ, SJO, SJOW, SJOOW, EVT, EVJT, EVE, EVJE	15/125
YP-11W	1-15P	18/2	SPT-1, SPT-2, SPT-3, NISPT-2, SVT, SVTO, SJT, SJTW, SJTO, SJTOW (All TPE material), SPT-1, SPT-1W, NISPT-1, SPT-2, SPT-2W, NISPT-2, SPT-3, HPN, SVT, SVTO, SJT, SJTW, , SJTO, SJTOW, SV, SVO, SJ, SJO, SJOW, SJOOW, EVT, EVJT, EVE, EVJE	7 or 10/125
		17/2	SVT, SVTO (All TPE material), SVT, SVTO, SV, SVO, SJ, SJO, SJOW, SJOOW, EVT, EVJT, EVE, EVJE	12/125
		16/2	SPT-2, SPT-3, NISPT-2, SVT, SVTO, SJT, SJTW, SJTO, SJTOW (All TPE material), SPT-2, SPT-2W, NISPT-2, SPT-3, SVT, SVTO, SJT, SJTW, SJTO, SJTOW, SV, SVO, SJ, SJO, SJOW, SJOOW, EVT, EVJT, EVE, EVJE	13/125
		16/2	HPN	15/125
		14/2	SPT-3, SJT, SJTW, SJTO, SJTOW (All TPE material), SPT-3, SJT, SJTW, SJTO, SJTOW, SJ, SJO, SJOW, SJOOW, EVT, EVJT, EVE, EVJE	15/125

		14/3	SJT, SJTW, SJTO, SJTOW, ST, STW, STOW, SPT-3 (All TPE material), SJT, SJTW, SJTO, SJTOW, ST, STW, STOW, SO, SOW, SOOW, SPT-3, EVT, EVJT, EVE, EVJE	15/250
		12/3	SJT, SJTW, SJTO, SJTOW, ST, STW, STOW, SPT-3 (All TPE material), SJT, SJTW, SJTO, SJTOW, ST, STW, STOW, SO, SOW, SOOW, SPT-3, EVT, EVJT, EVE, EVJE	15/250
YP-31	IEC C8	18/2	SVT, SVTO, SJT, SJTW, SJTO, SJTOW, SPT-1, SPT-2, NISPT-2 (All TPE material), SVT, SVTO, SJT, SJTW, SJTO, SJTOW, SV, SVO, SJ, SJO, SJOW, SJOOW, SPT-1, SPT-1W, SPT-2, SPT-2W, NISPT-1, NISPT-2, EVT, EVJT, EVE, EVJE	7/125, 2.5/250
YP-32, YP-32L, YP-32L-1, YP-32L-2, YP-32L-3	IEC C14	18/3	SVT, SJT, SJTW, SJTO, SJTOW, ST, STW, STOW (All TPE material, Shielded and Non-shielded for all types), SVT, SJT, SJTW, SJTO, SJTOW, ST, STW, STOW, SJ, SJO, SJO, SJOW, SJOOW, SO, SOO, SOW, SOOW (Shielded or Non-shielded for all types), EVT, EVJT, EVE, EVJE	2.5, 7 or 10/125 or 250
		17/3	SVT, SJT, SJTW, SJTO, SJTOW, ST, STW, STOW (All TPE material, Shielded and Non-shielded for all types), SVT, SJT, SJTW, SJTO, SJTOW, ST, STW, STOW, SJ, SJO, SJO, SJOW, SJOOW, SO, SOO, SOW, SOOW (Shielded or Non-shielded for all types), EVT, EVJT, EVE, EVJE	10, 12/125 or 250
		16/3	SJT, SJTW, SJTO, SJTOW, ST, STW, STOW (All TPE material, Shielded and Non-shielded for all types), SJT, SJTW, SJTO, SJTOW, ST, STW, STOW, SJ, SJO, SJO, SJOW, SJOOW, SO, SOO, SOW, SOOW (Shielded or Non-shielded for all types), EVT, EVJT, EVE, EVJE	13/125 or 250
		15/3	SJT, SJTW, SJTO, SJTOW, ST, STW, STOW (All TPE material, Shielded and Non-shielded for all types), SJT, SJTW, SJTO, SJTOW, ST, STW, STOW, SJ, SJO, SJO, SJOW, SJOOW, SO, SOO, SOW, SOOW (Shielded or Non-shielded for all types), EVT, EVJT, EVE, EVJE	14/125 or 250
		14/3	SJT, SJTW, SJTO, SJTOW, ST, STW, STOW (All TPE material, Shielded and Non-shielded for all types), SJT, SJTW, SJTO, SJTOW, ST, STW, STOW, SJ, SJO, SJO, SJOW, SJOOW, SO, SOO, SOW, SOOW (Shielded or Non-shielded for all types), EVT, EVJT, EVE, EVJE	15/125 or 250
YP-12D	5-15	18/3	SVT, SJT, SJT Shielded, SJTW, SJTO, SJTOW (All TPE material), SVT, SJT, SJT Shielded, SJTW, SJTO, SJTOW, EVT, EVJT, EVE, EVJE	7 or 10/125
		16/3	SVT, SJT, SJT Shielded, SJTW, SJTO, SJTOW (All TPE material), SVT, SJT, SJT Shielded, SJTW, SJTO, SJTOW, EVT, EVJT, EVE, EVJE	13/125
		14/3	SVT, SJT, SJT Shielded, SJTW, SJTO, SJTOW (All TPE material), SVT, SJT, SJT Shielded, SJTW, SJTO, SJTOW, EVT, EVJT, EVE, EVJE	15/125
YP-32A	IEC C14	18/3	SVT, SJT, SJT Shielded, SJTW, SJTO, SJTOW (All TPE material), SVT, SJT, SJT Shielded, SJTW, SJTO, SJTOW, EVT, EVJT, EVE, EVJE	2.5, 7 or 10/250
		16/3	SVT, SJT, SJT Shielded, SJTW, SJTO, SJTOW (All TPE material), SVT, SJT, SJT Shielded, SJTW, SJTO, SJTOW, EVT, EVJT, EVE, EVJE	13/250

		15	SJT, SJTW, SJTO, SJTOW, SJTOOW, ST, STW, STOW, STOOW, SPT-3 (All TPE material), SJT, SJTW, SJTO, SJTOW, SJTOOW, SJ, SJO, SJOO, SJOW, SJOOW, ST, STW, STOW, STOOW, S, SO, SOW, SOO, SOOW, SPT-3	16/125 or 250
		14	SJT, SJTW, SJTO, SJTOW, SJTOOW, ST, STW, STOW, STOOW, SPT-3 (All TPE material), SJT, SJTW, SJTO, SJTOW, SJTOOW, SJ, SJO, SJOO, SJOW, SJOOW, ST, STW, STOW, STOOW, S, SO, SOW, SOO, SOOW, SPT-3	16/125 or 250
		12	SJT, SJTW, SJTO, SJTOW, SJTOOW, ST, STW, STOW, STOOW, SPT-3 (All TPE material), SJT, SJTW, SJTO, SJTOW, SJTOOW, SJ, SJO, SJOO, SJOW, SJOOW, ST, STW, STOW, STOOW, S, SO, SOW, SOO, SOOW, SPT-3	20/125 or 250 V ac
YC-18L	IEC C19	16	SJT, SJTW, SJTO, SJTOW, SJTOOW, ST, STW, STOW, STOOW, SPT-3 (All TPE material), SJT, SJTW, SJTO, SJTOW, SJTOOW, SJ, SJO, SJOO, SJOW, SJOOW, ST, STW, STOW, STOOW, S, SO, SOW, SOO, SOOW, SPT-3	13/125 or 250 V ac
		15	SJT, SJTW, SJTO, SJTOW, SJTOOW, ST, STW, STOW, STOOW, SPT-3 (All TPE material), SJT, SJTW, SJTO, SJTOW, SJTOOW, SJ, SJO, SJOO, SJOW, SJOOW, ST, STW, STOW, STOOW, S, SO, SOW, SOO, SOOW, SPT-3	250 V ac
		14	SJT, SJTW, SJTO, SJTOW, SJTOOW, ST, STW, STOW, STOOW, SPT-3 (All TPE material), SJT, SJTW, SJTO, SJTOW, SJTOOW, SJ, SJO, SJOO, SJOW, SJOOW, ST, STW, STOW, STOOW, S, SO, SOW, SOO, SOOW, SPT-3	16/125 or 250 V ac
		12	SJT, SJTW, SJTO, SJTOW, SJTOOW, ST, STW, STOW, STOOW, SPT-3 (All TPE material), SJT, SJTW, SJTO, SJTOW, SJTOOW, SJ, SJO, SJOO, SJOW, SJOOW, ST, STW, STOW, STOOW, S, SO, SOW, SOO, SOOW, SPT-3	20/125 or 250 V ac
YC-20	IEC C15	18	SVT, SJT, SJTW, SJTO, SJTOW, ST, STW, STOW, SPT-3 (All TPE material), SVT, SJT, SJTW, SJTO, SJTOW, ST, STW, STOW, SO, SOW, SOOW, SPT-3	2.5, 7 or 10/125 or 250
		17	SVT, SJT, SJTW, SJTO, SJTOW, ST, STW, STOW, SPT-3 (All TPE material), SVT, SJT, SJTW, SJTO, SJTOW, ST, STW, STOW, SO, SOW, SOOW, SPT-3	12/125 or 250
		16	SJT, SJTW, SJTO, SJTOW, ST, STW, STOW, SPT-3 (All TPE material), SJT, SJTW, SJTO, SJTOW, ST, STW, STOW, SO, SOW, SOOW, SPT-3	13/125 or 250
		15	SJT, SJTW, SJTO, SJTOW, ST, STW, STOW, SPT-3 (All TPE material), SJT, SJTW, SJTO, SJTOW, ST, STW, STOW, SO, SOW, SOOW, SPT-3	14/125 or 250
		14	SJT, SJTW, SJTO, SJTOW, ST, STW, STOW, SPT-3 (All TPE material), SJT, SJTW, SJTO, SJTOW, ST, STW, STOW, SO, SOW, SOOW	15/125 or 250
YC-25	IEC C21	16	SJT, SJTW, SJTO, SJTOW, SJTOOW, ST, STW, STOW, STOOW, SPT-3 (All TPE material), SJT, SJTW, SJTO, SJTOW, SJTOOW, SJ, SJO, SJOO, SJOW, SJOOW, ST, STW, STOW, STOOW, S, SO, SOW, SOO, SOOW, SPT-3	13/125 or 250
		15	SJT, SJTW, SJTO, SJTOW, SJTOOW, ST, STW, STOW, STOOW, SPT-3 (All TPE material), SJT, SJTW, SJTO, SJTOW, SJTOOW, SJ, SJO, SJOO, SJOW, SJOOW, ST, STW, STOW, STOOW, S, SO, SOW, SOO, SOOW, SPT-3	16/125 or 250
		14	SJT, SJTW, SJTO, SJTOW, SJTOOW, ST, STW, STOW, STOOW, SPT-3 (All TPE material), SJT, SJTW, SJTO, SJTOW, SJTOOW, SJ, SJO, SJOO, SJOW, SJOOW, ST, STW, STOW, STOOW, S, SO, SOW, SOO, SOOW, SPT-3	16/125 or 250
		12	SJT, SJTW, SJTO, SJTOW, SJTOOW, ST, STW, STOW, STOOW, SPT-3 (All TPE material), SJT, SJTW, SJTO, SJTOW, SJTOOW, SJ, SJO, SJOO, SJOW, SJOOW, ST, STW, STOW, STOOW, S, SO, SOW, SOO, SOOW, SPT-3	20/125 or 250
YC-25L	IEC C21	16	SJT, SJTW, SJTO, SJTOW, SJTOOW, ST, STW, STOW, STOOW, SPT-3 (All TPE material), SJT, SJTW, SJTO, SJTOW, SJTOOW, SJ, SJO, SJOO, SJOW, SJOOW, ST, STW, STOW, STOOW, S, SO, SOW, SOO, SOOW, SPT-3	13/125 or 250 V ac

ZEICHENGENEHMIGUNG MARKS APPROVAL

Yung-Li Co. Ltd.
Da Pu Industrial Zone, Cang Zi
Chang Ping Town
523571 DONG GUAN CITY
Guangdong
CHINA

ist berechtigt, für ihr Produkt /
is authorized to use for their product

Geräteanschlußstecker, nichtwiederanschließbar
Plug connector, non-rewirable

die hier abgebildeten markenrechtlich geschützten Zeichen
für die ab Blatt 2 aufgeführten Typen zu benutzen /
the legally protected Marks as shown below for the types referred to on page 2 ff.



Geprüft und zertifiziert nach /
Tested and certified according to

DIN EN 60320-1 (VDE 0625-1):2016-04; EN 60320-1:2015+AC:2016
DIN EN 60320-3 (VDE 0625-3):2015-11; EN 60320-3:2014
IEC 60320-1:2015
IEC 60320-3:2014

Aktenzeichen: 1609800-1550-0004 / 232788

File ref.:

Ausweis-Nr. 40029462

Blatt 1

Certificate No.

Page

Weitere Bedingungen siehe Rückseite und Folgeblätter /
further conditions see overleaf and following pages

Offenbach, 2010-02-19

(letzte Änderung / updated 2017-07-17)

VDE Prüf- und Zertifizierungsinstitut GmbH
VDE Testing and Certification Institute
Zertifizierungsstelle / Certification

R. Nickel

VDE Zertifikate sind nur gültig bei Veröffentlichung unter:
VDE certificates are valid only when published on:

<http://www.vde.com/zertifikat>
<http://www.vde.com/certificate>

Name und Sitz des Genehmigungs-Inhabers / Name and registered seat of the Certificate holder

Yung-Li Co. Ltd., Da Pu Industrial Zone, Cang Zi, Chang Ping Town, 523571 DONG GUAN CITY, Guangdong, CHINA

Aktenzeichen / File ref.

1609800-1550-0004 / 232788 / CC1 / E

letzte Änderung / updated

2017-07-17

Datum / Date

2010-02-19

Dieses Blatt gilt nur in Verbindung mit Blatt 1 des Zeichengenehmigungsausweises Nr. 40029462.

This supplement is only valid in conjunction with page 1 of the Certificate No. 40029462.

Geräteanschlußstecker, nichtwiederanschließbar Plug connector, non-rewirable

Typ(en) / Type(s)

- 1) YP-32
- 2) YP-32L

Bemessungsspannung
Rated voltage

AC 250 V

Bemessungsstrom
Rated current

10 A

Polzahl
Number of poles

2-polig mit Schutzkontakt
2-pole with earthing contact

Bauart
Kind of construction

Normblatt E
standard sheet E

Ausführung(en)
Construction(s)

zentrale Leitungseinführung
straight cable entry
Für / for 1)

abgewinkelte Leitungseinführung
angled cable entry
Für / for 2)

Warenzeicheninhaber
Trademark holder

Yung-Li Co. Ltd.

Produktinformation
Product information

siehe Anlage Nr. 300 + 700 + 900 vom 2017-07-17
see Appendix No. 300 + 700 + 900 dated 2017-07-17

Dieser Zeichengenehmigungs-Ausweis bildet eine Grundlage für die EG-Konformitätserklärung und CE-Kennzeichnung durch den Hersteller oder dessen Bevollmächtigten und bescheinigt die Konformität mit den grundlegenden Schutzanforderungen der **EG-Niederspannungsrichtlinie 2014/35/EU**.

*This Marks Approval is a basis for the EC Declaration of Conformity and the CE Marking by the manufacturer or his agent and proves the conformity with the essential safety requirements of the **EC Low-Voltage Directive 2014/35/EU**.*

Fortsetzung siehe Blatt 3 /
continued on page 3

VDE Prüf- und Zertifizierungsinstitut Zeichengenehmigung

Ausweis-Nr. / Blatt /
Certificate No. / Page
40029462 / 3

Name und Sitz des Genehmigungs-Inhabers / *Name and registered seat of the Certificate holder*

Yung-Li Co. Ltd., Da Pu Industrial Zone, Cang Zi, Chang Ping Town, 523571 DONG GUAN CITY, Guangdong, CHINA

Aktenzeichen / *File ref.*

1609800-1550-0004 / 232788 / CC1 / E

letzte Änderung / *updated*

2017-07-17

Datum / *Date*

2010-02-19

Dieses Blatt gilt nur in Verbindung mit Blatt 1 des Zeichengenehmigungsausweises Nr. 40029462.

This supplement is only valid in conjunction with page 1 of the Certificate No. 40029462.

VDE Prüf- und Zertifizierungsinstitut GmbH

VDE Testing and Certification Institute

Fachgebiet CC1

Section CC1



VDE Prüf- und Zertifizierungsinstitut Zeichengenehmigung

Ausweis-Nr. / Beiblatt /
Certificate No. Supplement
40029462

Name und Sitz des Genehmigungs-Inhabers / *Name and registered seat of the Certificate holder*

Yung-Li Co. Ltd., Da Pu Industrial Zone, Cang Zi, Chang Ping Town, 523571 DONG GUAN CITY, Guangdong, CHINA

Aktenzeichen / *File ref.*

1609800-1550-0004 / 232788 / CC1 / E

letzte Änderung / *updated*

2017-07-17

Datum / *Date*

2010-02-19

Dieses Beiblatt ist Bestandteil des Zeichengenehmigungsausweises Nr. 40029462.

This supplement is part of the Certificate No. 40029462.

Geräteanschlußstecker, nichtwiederanschließbar *Plug connector, non-rewirable*

Fertigungsstätte(n)

Place(s) of manufacture

Referenz/*Reference*
30008928

Yung-Li Co. Ltd.
Da Pu Industrial Zone, Cang Zi
Chang Ping Town
523571 DONG GUAN CITY
Guangdong
CHINA

VDE Prüf- und Zertifizierungsinstitut GmbH
VDE Testing and Certification Institute
Fachgebiet CC1
Section CC1

VDE Prüf- und Zertifizierungsinstitut

Aktenzeichen:
File reference: **1609800-1550-0019/164049**

Ausweis-Nr.:
Certificate No.: **40035051**

Anlage Nr.:
Appendix No.: **400**

Seite:
Page: **1 / 1**

Datum:
Date: **2012-05-22**

Diese Anlage ist Bestandteil des Genehmigungsausweises. This appendix is part of the certificate.

Gerätesteckdose, nicht-wiederanschließbar
Connector, non-rewritable

2-polig mit Schutzkontakt
2-pole with earthing contact

abgewinkelte Leitungseinführung
angled cable entry

Fertigungsstätte / Place of manufacture:

30008928 : Kennzeichnung / Identification : ---

Werkstoff der Umspritzung:
Material of the moulding:

Typ: Farbe
Type: colour

PVC; alle Farben / all colours

Werkstoff der Trägereile:
Material of the base:

Typ: Hersteller; Farbe
Type; manufacturer; colour

Insert:
PBT type 4115F;
CHANG CHUN
PLASTICS CO LTD
weiß/white;



Cover:
PBT type 4115F;
CHANG CHUN
PLASTICS CO LTD
schwarz/black;

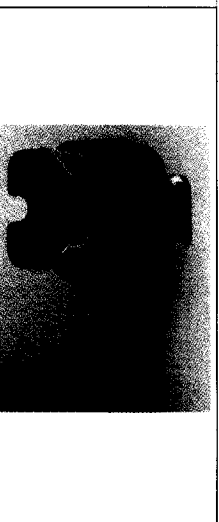

Inneneinsatz:
Insert:

Typ: Hersteller
Type: manufacturer

Position im VDE-Ausweis Position in VDE-licence	Typ(en) Type(s)	Leitungsaufdruck Marking on cable	<p style="text-align: center;">X Δ genehmigte Ausführung / approved version</p>						<p style="text-align: center;">--- Δ nicht genehmigt / not approved</p>										
YC-20L		YUNG LI	<input type="checkbox"/>	<input type="checkbox"/>	<input type="checkbox"/>	<input type="checkbox"/>	<input type="checkbox"/>	<input type="checkbox"/>	<input type="checkbox"/>	<input checked="" type="checkbox"/>	<input checked="" type="checkbox"/>	<input checked="" type="checkbox"/>	<input type="checkbox"/>	<input type="checkbox"/>	<input type="checkbox"/>	<input type="checkbox"/>	<input type="checkbox"/>	<input type="checkbox"/>	<input type="checkbox"/>
			<input type="checkbox"/>	<input type="checkbox"/>	<input type="checkbox"/>	<input type="checkbox"/>	<input type="checkbox"/>	<input type="checkbox"/>	<input type="checkbox"/>	<input type="checkbox"/>	<input type="checkbox"/>	<input type="checkbox"/>	<input type="checkbox"/>	<input type="checkbox"/>	<input type="checkbox"/>	<input type="checkbox"/>	<input type="checkbox"/>	<input type="checkbox"/>	<input type="checkbox"/>
			<input type="checkbox"/>	<input type="checkbox"/>	<input type="checkbox"/>	<input type="checkbox"/>	<input type="checkbox"/>	<input type="checkbox"/>	<input type="checkbox"/>	<input type="checkbox"/>	<input type="checkbox"/>	<input type="checkbox"/>	<input type="checkbox"/>	<input type="checkbox"/>	<input type="checkbox"/>	<input type="checkbox"/>	<input type="checkbox"/>	<input type="checkbox"/>	<input type="checkbox"/>
			<input type="checkbox"/>	<input type="checkbox"/>	<input type="checkbox"/>	<input type="checkbox"/>	<input type="checkbox"/>	<input type="checkbox"/>	<input type="checkbox"/>	<input type="checkbox"/>	<input type="checkbox"/>	<input type="checkbox"/>	<input type="checkbox"/>	<input type="checkbox"/>	<input type="checkbox"/>	<input type="checkbox"/>	<input type="checkbox"/>	<input type="checkbox"/>	<input type="checkbox"/>
			<input type="checkbox"/>	<input type="checkbox"/>	<input type="checkbox"/>	<input type="checkbox"/>	<input type="checkbox"/>	<input type="checkbox"/>	<input type="checkbox"/>	<input type="checkbox"/>	<input type="checkbox"/>	<input type="checkbox"/>	<input type="checkbox"/>	<input type="checkbox"/>	<input type="checkbox"/>	<input type="checkbox"/>	<input type="checkbox"/>	<input type="checkbox"/>	<input type="checkbox"/>
			<input type="checkbox"/>	<input type="checkbox"/>	<input type="checkbox"/>	<input type="checkbox"/>	<input type="checkbox"/>	<input type="checkbox"/>	<input type="checkbox"/>	<input type="checkbox"/>	<input type="checkbox"/>	<input type="checkbox"/>	<input type="checkbox"/>	<input type="checkbox"/>	<input type="checkbox"/>	<input type="checkbox"/>	<input type="checkbox"/>	<input type="checkbox"/>	<input type="checkbox"/>
			<input type="checkbox"/>	<input type="checkbox"/>	<input type="checkbox"/>	<input type="checkbox"/>	<input type="checkbox"/>	<input type="checkbox"/>	<input type="checkbox"/>	<input type="checkbox"/>	<input type="checkbox"/>	<input type="checkbox"/>	<input type="checkbox"/>	<input type="checkbox"/>	<input type="checkbox"/>	<input type="checkbox"/>	<input type="checkbox"/>	<input type="checkbox"/>	<input type="checkbox"/>
			<input type="checkbox"/>	<input type="checkbox"/>	<input type="checkbox"/>	<input type="checkbox"/>	<input type="checkbox"/>	<input type="checkbox"/>	<input type="checkbox"/>	<input type="checkbox"/>	<input type="checkbox"/>	<input type="checkbox"/>	<input type="checkbox"/>	<input type="checkbox"/>	<input type="checkbox"/>	<input type="checkbox"/>	<input type="checkbox"/>	<input type="checkbox"/>	<input type="checkbox"/>
			<input type="checkbox"/>	<input type="checkbox"/>	<input type="checkbox"/>	<input type="checkbox"/>	<input type="checkbox"/>	<input type="checkbox"/>	<input type="checkbox"/>	<input type="checkbox"/>	<input type="checkbox"/>	<input type="checkbox"/>	<input type="checkbox"/>	<input type="checkbox"/>	<input type="checkbox"/>	<input type="checkbox"/>	<input type="checkbox"/>	<input type="checkbox"/>	<input type="checkbox"/>



VDE Prüf- und Zertifizierungsinstitut

Aktenzeichen: **1609800-1550-0019/164049**
 File reference:

Ausweis-Nr.: **40035051**
 Certificate No.:

Anlage Nr.: **300**
 Appendix No.:

Seite: **1 / 1**
 Page:

Datum: **2012-05-22**
 Date:

Diese Anlage ist Bestandteil des Genehmigungsausweises. This appendix is part of the certificate.

Gerätesteckdose, nicht-wiederanschießbar
Connector, non-rewirable

2-polig mit Schutzkontakt
2-pole with earthing contact

zentrale Leitungseinführung
straight cable entry

Fertigungsstätte / Place of manufacture:

30008928 : Kennzeichnung / Identification :

Werkstoff der Umspritzung:
 Material of the moulding:

Typ: Farbe
 Type: colour

PVC; alle Farben / all colours

Werkstoff der Träger Teile:
 Material of the base:

Typ: Hersteller; Farbe
 Type: manufacturer; colour

Insert:
 PBT type 4115F;
 CHANG CHUN
 PLASTICS CO LTD
 weiß / white;

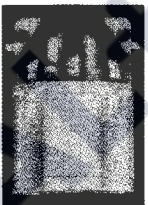

Cover:
 PBT type 4115F;
 CHANG CHUN
 PLASTICS CO LTD
 schwarz / black;

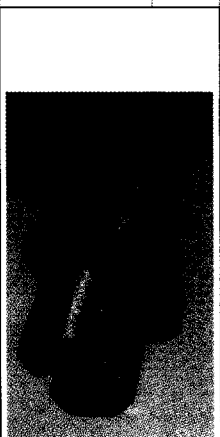

Inneneinsatz:
 Insert:

Typ: Hersteller
 Type: manufacturer

Position im VDE-Ausweis
 Position in VDE-licence

Typ(en)
 Type(s)

YC-20

Leitungsaufdruck
 Marking on cable

YUNG LI

X **genehmigte Ausführung / approved version**

--- **nicht genehmigt / not approved**

	H05VV-F 3G 0,75 mm ² (max. 2 m)										
	H05VV-F 3G 1,0 mm ²										
	H05VV-F 3G 1,5 mm ²										
	H05RR-F 3G 0,75 mm ² (max. 2 m)										
	H05RR-F 3G 1,0 mm ²										
	H05RR-F 3G 1,5 mm ²										
	H05RN-F 3G 0,75 mm ² (max. 2 m)										
	H05RN-F 3G 1,0 mm ²										
	H03RT-H 3G 0,75 mm ² (max. 2 m)										
	H03RT-H 3G 1,0 mm ²										
	H05V2V2-F 3G 0,75 mm ² (max. 2 m)										
X	H05V2V2-F 3G 1,0 mm ²										
X	H05V2V2-F 3G 1,5 mm ²										



VDE Prüf- und Zertifizierungsinstitut Zeichengenehmigung

Ausweis-Nr. / Infoblatt /
Certificate No. / Info sheet
40029462

Name und Sitz des Genehmigungs-Inhabers / Name and registered seat of the Certificate holder

Yung-Li Co. Ltd., Da Pu Industrial Zone, Cang Zi, Chang Ping Town, 523571 DONG GUAN CITY, Guangdong, CHINA

Aktenzeichen / File ref.

1609800-1550-0004 / 232788 / CC1 / E

letzte Änderung / updated

2017-07-17

Datum / Date

2010-02-19

Dieses Blatt gilt nur in Verbindung mit Blatt 1 des Zeichengenehmigungsausweises Nr. 40029462.

This supplement is only valid in conjunction with page 1 of the Certificate No. 40029462.

Genehmigung zum Benutzen des auf Seite 1 abgebildeten markenrechtlich geschützten Zeichens des VDE:

Grundlage für die Benutzung sind die Allgemeinen Geschäftsbedingungen (AGB) der VDE Prüf- und Zertifizierungsinstitut GmbH (www.vde.com\AGB-Institut). Das Recht zur Benutzung erstreckt sich nur auf die bezeichnete Firma mit den genannten Fertigungsstätten und die oben aufgeführten Produkte mit den zugeordneten Bezeichnungen. Die Fertigungsstätte muss so eingerichtet sein, dass eine gleichmäßige Herstellung der geprüften und zertifizierten Ausführung gewährleistet ist.

Die Genehmigung ist so lange gültig wie die VDE-Bestimmungen gelten, die der Zertifizierung zugrunde gelegen haben, sofern sie nicht auf Grund anderer Bedingungen aus der VDE Prüf- und Zertifizierungsordnung (PM102) zurückgezogen werden muss.

Der Gültigkeitszeitraum einer VDE-GS-Zeichengenehmigung kann auf Antrag verlängert werden. Bei gesetzlichen und / oder normativen Änderungen kann die VDE-GS-Zeichengenehmigung ihre Gültigkeit zu einem früheren als dem angegebenen Datum verlieren.

Produkte, die das Biozid Dimethylfumarat (DMF) enthalten, dürfen gemäß der Kommissionsentscheidung 2009/251/EG nicht mehr in den Verkehr gebracht oder auf dem Markt bereitgestellt werden.

Der VDE-Zeichengenehmigungsausweis wird ausschließlich auf der ersten Seite unterzeichnet.

Approval to use the legally protected Mark of the VDE as shown on the first page:

Basis for the use are the general terms and conditions of the VDE Testing and Certification Institute (www.vde.com\terms-institute). The right to use the mark is granted only to the mentioned company with the named places of manufacture and the listed products with the related type references. The place of manufacture shall be equipped in a way that a constant manufacturing of the certified construction is assured.

The approval is valid as long as the VDE specifications are in force, on which the certification is based on, unless it is withdrawn according to the VDE Testing and Certification Procedure (PM102E).

The validity period of a VDE-GS-Mark Approval may be prolonged on request. In case of changes in legal and / or normative requirements, the validity period of a VDE-GS-Mark Approval may be shortened.

Products containing the biocide dimethylfumarate (DMF) may not be marketed or made available on the EC market according to the Commission Decision 2009/251/EC.

The approval is solely signed on the first page.

適合同等証明書

Statement of Conformity Assessment

電気用品安全法第8条第1項に規定する技術基準及び同法第9条第2項の経済産業省令で定める基準（法第9条第1項第2号に係る検査に係るものに限る）に適合していることを証明します

I hereby certify that the product mentioned below complies with the technical requirements stipulated in Paragraph 1 of Article 8 of Electrical Appliances and Materials Safety Act (here under referred to as the Act) and the requirements defined by the ordinance of the Ministry of Economy, Trade and Industry based on Paragraph 2 of Article 9 of the Act (limited to Item 2 of Paragraph 1 of Article 9 for Inspection of the Act).

1. 証明書番号: JET5087-43001-1012
Statement Number
2. 交付年月日: 平成29年1月12日
Effective Date January 12, 2017
3. 有効年月日: 平成36年1月11日
Date of Validity January 11, 2024
4. 申込者名
(Applicant)
住所: DAPU INDUSTRIAL ZONE, GANGZI, CHANGPING TOWN,
DONGGUAN CITY, GUANGDONG PROVINCE, CHINA
Address

氏名又は名称: YUNG LI CO., LTD.
Name

5. 特定電気用品名: 差込みプラグ
Name of Product Attachment plugs
6. 型式の区分: 別紙のとおり
Type Classification See attached "Type Classification"
7. 製造工場名
(Manufacturer)
住所: DAPU INDUSTRIAL ZONE, GANGZI, CHANGPING TOWN,
DONGGUAN CITY, GUANGDONG PROVINCE, CHINA
Address

氏名又は名称: YUNG LI CO., LTD.
Name

8. 適用試験規格: 電気用品の技術上の基準を定める省令の解釈
Applied Standard for Testing Description of the technical requirements by the METI Ordinance
別表第四1、6及び別表第十 第5章

Appendix 4 Section 1, Section 6 and Appendix 10 Chapter 5

9. 適合性検査の方法: (Testing Method for Conformity Assessment)
 - 1) 試験用の特定電気用品については、電気用品の技術上の基準を定める省令の解釈に定める方法
With respect to testing for Category A products, the testing method is based on the technical requirements of the description of Electrical Appliances and Materials stipulated in the METI Ordinance.
 - 2) 当該特定電気用品に係る届出事業者又は事業場における検査設備については、電気用品安全法施行規則別表第四の検査設備の欄に掲げる検査設備ごとにそれぞれ同表の技術上の基準の欄に掲げる方法
With respect to inspection facilities required for Category A products at the factory, Testing Method described in the column of the technical requirements for each inspection facilities in the column of inspection facilities is shown in the Appendix 4 of Enforcement Regulations of the Act.

10. 注意事項

- 1) この適合同等証明書は、提出された試験用の電気用品に関して評価を行った上で交付したものであり、同一の型式の区分にある電気用品について電気用品安全法第8条1項に規定する技術基準適合確認の義務を履行したことを示すものではありません。

This Statement of Conformity Assessment, which is issued on the evaluation of the submitted test-use Electrical Appliances and Materials, does not signify that the Obligation to Comply with Requirements, which is prescribed at Paragraph 1 of Article 8 of the Act, is fulfilled on Electrical Appliances and Materials in the same Type Classification.

- 2) この適合同等証明書は、別紙に記載されている型式の区分の範囲内及び区分の組み合わせについてのみ有効です。

This Statement of Conformity Assessment is valid only for Electrical Appliances and Materials within the Type Classifications and their combination as stated in the attached "Type Classification".

一般財団法人 電気安全環境研究所
Japan Electrical Safety & Environment technology Laboratories (JET)

理事長 薦田 康久
President Yasuhisa Komoda

東京都渋谷区代々木5-14-12
(5-14-12, Yoyogi, Shibuya-ku, Tokyo, Japan)

証明書番号 : JET5087-43001-1012

適合同等証明書別紙

Statement of Conformity Assessment

型式の区分

Type Classification

要素 Factor	区分 Classification
定格電圧 Rated voltage	(2) 125Vを超えるもの Exceeding 125V
定格電流 Rated current	(3) 7Aを超え15A以下のもの Exceeding 7A, and less than or equal to 15A
極の配置（別表第二の一aに掲げる寸法に適合するもの場合に限る。） Pole configuration (limited to those specified in sub-clause 1a of Appendix 2)	—
極の数（別表第二の一bに掲げる寸法に適合するもの場合に限る。） Number of poles (limited to those specified in sub-clause 1b of Appendix 2)	(2) アース極を含めて3のもの Three including earth
刃の取付けの方式 Blade fixing method	(1) 一体として成形されているもの Integrated type
主絶縁体の材料 Insulation materials	(1) 合成樹脂のもの Plastic
外郭の材料 Outer case materials	(2) 合成樹脂のもの Plastic
接続の方式 Connection method	(1) 差し込み型のもの（ロックナット式のものを除く。） Plug-in type (excluding those with locking nuts)
防水構造 Type of waterproof	(3) 非防水型のもの Not treated with waterproof type

証明書番号：JET5087-43001-1012

適合同等証明書

Statement of Conformity Assessment

電気用品安全法第8条第1項に規定する技術基準及び同法第9条第2項の経済産業省令で定める基準（法第9条第1項第2号に係る検査に係るものに限る）に適合していることを証明します

I hereby certify that the product mentioned below complies with the technical requirements stipulated in Paragraph 1 of Article 8 of Electrical Appliances and Materials Safety Act (here under referred to as the Act) and the requirements defined by the ordinance of the Ministry of Economy, Trade and Industry based on Paragraph 2 of Article 9 of the Act (limited to Item 2 of Paragraph 1 of Article 9 for Inspection of the Act).

1. 証明書番号: JET5087-43004-1004
Statement Number
2. 交付年月日: 平成29年1月12日
Effective Date January 12, 2017
3. 有効年月日: 平成36年1月11日
Date of Validity January 11, 2024
4. 申込者名 (Applicant)
住所: DAPU INDUSTRIAL ZONE, GANGZI, CHANGPING TOWN,
DONGGUAN CITY, GUANGDONG PROVINCE, CHINA

氏名又は名称: YUNG LI CO., LTD.
Name

5. 特定電気用品名: コードコネクターボディ
Name of Product Cord connector bodies
6. 型式の区分: 別紙のとおり
Type Classification See attached "Type Classification"
7. 製造工場名 (Manufacturer)
住所: DAPU INDUSTRIAL ZONE, GANGZI, CHANGPING TOWN,
DONGGUAN CITY, GUANGDONG PROVINCE, CHINA

氏名又は名称: YUNG LI CO., LTD.
Name

8. 適用試験規格: 電気用品の技術上の基準を定める省令の解釈
Applied Standard for Testing Description of the technical requirements by the METI Ordinance
別表第四1、6及び別表第十 第五章
Appendix 4 Section 1, Section 6 and Appendix 10 Chapter 5

9. 適合性検査の方法: (Testing Method for Conformity Assessment)

- 1) 試験用の特定電気用品については、電気用品の技術上の基準を定める省令の解釈に定める方法

With respect to testing for Category A products, the testing method is based on the technical requirements of the description of Electrical Appliances and Materials stipulated in the METI Ordinance.

- 2) 当該特定電気用品に係る届出事業者又は事業場における検査設備については、電気用品安全法施行規則別表第四の検査設備の欄に掲げる検査設備ごとにそれぞれ同表の技術上の基準の欄に掲げる方法

With respect to inspection facilities required for Category A products at the factory, Testing Method described in the column of the technical requirements for each inspection facilities in the column of inspection facilities is shown in the Appendix 4 of Enforcement Regulations of the Act.

10. 注意事項

- 1) この適合同等証明書は、提出された試験用の電気用品に関して評価を行った上で交付したものであり、同一の型式の区分にある電気用品について電気用品安全法第8条1項に規定する技術基準適合確認の義務を履行したことを示すものではありません。

This Statement of Conformity Assessment, which is issued on the evaluation of the submitted test-use Electrical Appliances and Materials, does not signify that the Obligation to Comply with Requirements, which is prescribed at Paragraph 1 of Article 8 of the Act, is fulfilled on Electrical Appliances and Materials in the same Type Classification.

- 2) この適合同等証明書は、別紙に記載されている型式の区分の範囲内及び区分の組み合わせについてのみ有効です。

This Statement of Conformity Assessment is valid only for Electrical Appliances and Materials within the Type Classifications and their combination as stated in the attached "Type Classification".

一般財団法人 電気安全環境研究所
Japan Electrical Safety & Environment Technology Laboratories (JET)

理事長 薦田 康久
President Yasuhisa Komoda

東京都渋谷区代々木5-14-12
(5-14-12, Yoyogi, Shibuya-ku, Tokyo, Japan)

証明書番号：JET5087-43004-1004

適合同等証明書別紙

Statement of Conformity Assessment

型式の区分

Type Classification

要素 Factor	区分 Classification
定格電圧 Rated voltage	(2) 125Vを超えるもの Exceeding 125V
定格電流 Rated current	(3) 7Aを超え10A以下のもの Exceeding 7A, and less than or equal to 10A
極の配置（別表第二の一aに掲げる寸法に適合するもの場合に限る。） Pole configuration (limited to those specified in sub-clause 1a of Appendix 2)	—
極の数（別表第二の一bに掲げる寸法に適合するもの場合に限る。） Number of poles (limited to those specified in sub-clause 1b of Appendix 2)	(2) アース極を含めて3のもの Three including earth
接続の方式 Connection method	(1) 差し込み型のもの（ロックナット式のものを除く。） Plug-in type (excluding those with locking nuts)
接続する電線の種類（一般固定配線用のもの場合に限る。） Type of cable or cord to be connected (limited to socket outlets)	—
主絶縁体の材料 Insulation materials	(1) 合成樹脂のもの Plastic
外郭の材料 Outer case materials	(2) 合成樹脂のもの Plastic
スイッチ Switch	(2) ないもの Without switch
種類（一般固定配線用のもの場合に限る。） Type (limited to socket outlets)	—
使用の方法（コンセントの場合に限る。） Method of use (limited to socket outlets)	—
電源との接続の方式（マルチタップの場合に限る。） Power supply terminals (limited to multiple socket-outlet (with cord or pins for power supply connections))	—
電線と器体との一体成形（コンセントの場合を除く。） Non-rewirable construction (except socket outlets)	(1) あるもの With non-rewirable construction
防水構造 Type of waterproof	(3) 非防水型のもの Not treated with waterproof type

証明書番号：JET5087-43004-1004



ZJCZ.E241374 Flexible Cord

[Page Bottom](#)

Flexible Cord

[See General Information for Flexible Cord](#)

YUNG LI CO LTD

E241374

7F-12 NO 99 SEC 1 XINTAI 5TH RD
XIZHI DISTRICT
NEW TAIPEI, 22175 TAIWAN

Decorative cord, Type(s) SPT-1W, SPT-2W

Dryer and range cord, Type(s) SRDT

Jacketed cord, Type(s) S, SE, SE-HF, SJ, SJE, SJE-HF, SJO, SJO, SJOOW, SJOW, SJJ, SJJ-B, SJTO, SJTOW, SJTW, SO, SOO, SOOW, SOW, ST, ST-B, STO, STOW, STW, SVE, SVE-HF, SVT, SVT-B, SVTO

Parallel cord, Type(s) NISPE-1, NISPE-1-HF, NISPE-2, NISPE-2-HF, NISPT-1, NISPT-2, SPE-1, SPE-1-HF, SPE-2, SPE-2-HF, SPE-3, SPE-3-HF, SPT-1, SPT-2, SPT-3

[Last Updated](#) on 2016-03-07

[Questions?](#)

[Print this page](#)

[Terms of Use](#)

[Page Top](#)

◆ 2016 UL LLC

The appearance of a company's name or product in this database does not in itself assure that products so identified have been manufactured under UL's Follow-Up Service. Only those products bearing the UL Mark should be considered to be Certified and covered under UL's Follow-Up Service. Always look for the Mark on the product.

UL permits the reproduction of the material contained in the Online Certification Directory subject to the following conditions: 1. The Guide Information, Assemblies, Constructions, Designs, Systems, and/or Certifications (files) must be presented in their entirety and in a non-misleading manner, without any manipulation of the data (or drawings). 2. The statement "Reprinted from the Online Certifications Directory with permission from UL" must appear adjacent to the extracted material. In addition, the reprinted material must include a copyright notice in the following format: "© 2016 UL LLC".

ZEICHENGENEHMIGUNG MARKS APPROVAL

Yung-Li Co. Ltd.
Da Pu Industrial Zone, Cang Zi
Chang Ping Town
523571 DONG GUAN CITY
Guangdong
CHINA

ist berechtigt, für ihr Produkt /
is authorized to use for their product

Starkstromleitungen für allgemeine Anwendungen
- Flexible Leitungen
mit thermoplastischer PVC-Isolierung
Cables for general applications
- Flexible cables with
thermoplastic PVC insulation

die hier abgebildeten markenrechtlich geschützten Zeichen
für die ab Blatt 2 aufgeführten Typen zu benutzen /
the legally protected Marks as shown below for the types referred to on page 2 ff.



Geprüft und zertifiziert nach /
Tested and certified according to

DIN EN 50525-2-11 (VDE 0285-525-2-11):2012-01; EN 50525-2-11:2011

VDE Prüf- und Zertifizierungsinstitut GmbH
VDE Testing and Certification Institute
Zertifizierungsstelle / *Certification*

M. Tasotti

M. Tasotti

Aktenzeichen: 1609800-5140-0012 / 203418

File ref.:

Ausweis-Nr. 40026715

Blatt 1

Certificate No.

Page

Weitere Bedingungen siehe Rückseite und Folgeblätter /
further conditions see overleaf and following pages

Offenbach, 2009-02-27

(letzte Änderung / updated 2015-01-22)

VDE Zertifikate sind nur gültig bei Veröffentlichung unter:
VDE certificates are valid only when published on:

<http://www.vde.com/zertifikat>
<http://www.vde.com/certificate>

Name und Sitz des Genehmigungs-Inhabers / Name and registered seat of the Certificate holder

Yung-Li Co. Ltd., Da Pu Industrial Zone, Cang Zi, Chang Ping Town, 523571 DONG GUAN CITY, Guangdong, CHINA

Aktenzeichen / File ref.

1609800-5140-0012 / 203418 / CC5 / HEG

letzte Änderung / updated

2015-01-22

Datum / Date

2009-02-27

Dieses Blatt gilt nur in Verbindung mit Blatt 1 des Zeichengenehmigungsausweises Nr. 40026715.

This supplement is only valid in conjunction with page 1 of the Certificate No. 40026715.

Starkstromleitungen für allgemeine Anwendungen - Flexible Leitungen mit thermoplastischer PVC-Isolierung *Cables for general applications - Flexible cables with thermoplastic PVC insulation*

Typ(en) / Type(s)

H03V2V2-F 2...4 x 0,5...0,75 mm²

+

H03V2V2H2-F 2 x 0,5...0,75 mm²

+

H05V2V2-F 2...5 x 0,75...4 mm²

+

H05V2V2H2-F 2 x 0,75...1,0 mm²

+

Leitungsbauart
Type of cable

Wärmebeständige Leitungen (90 °C)
Heat resistant cable 90 °C

Firmenzeichen
Trademark

YUNG LI

Dieser Zeichengenehmigungs-Ausweis bildet eine Grundlage für die EG-Konformitätserklärung und CE-Kennzeichnung durch den Hersteller oder dessen Bevollmächtigten und bescheinigt die Konformität mit den grundlegenden Schutzanforderungen der **EG-Niederspannungsrichtlinie 2006/95/EG** mit ihren Änderungen.
*This Marks Approval is a basis for the EC Declaration of Conformity and the CE Marking by the manufacturer or his agent and proves the conformity with the essential safety requirements of the **EC Low-Voltage Directive 2006/95/EC** including amendments.*

VDE Prüf- und Zertifizierungsinstitut GmbH
VDE Testing and Certification Institute
Fachgebiet CC5
Section CC5

VDE Prüf- und Zertifizierungsinstitut Zeichengenehmigung

Ausweis-Nr. / Beiblatt /
Certificate No. Supplement
40026715

Name und Sitz des Genehmigungs-Inhabers / *Name and registered seat of the Certificate holder*

Yung-Li Co. Ltd., Da Pu Industrial Zone, Cang Zi, Chang Ping Town, 523571 DONG GUAN CITY, Guangdong, CHINA

Aktenzeichen / *File ref.*

1609800-5140-0012 / 203418 / CC5 / HEG

letzte Änderung / *updated*

2015-01-22

Datum / *Date*

2009-02-27

Dieses Beiblatt ist Bestandteil des Zeichengenehmigungsausweises Nr. 40026715.

This supplement is part of the Certificate No. 40026715.

Starkstromleitungen für allgemeine Anwendungen - Flexible Leitungen mit thermoplastischer PVC-Isolierung

***Cables for general applications
- Flexible cables with
thermoplastic PVC insulation***

Fertigungsstätte(n)

Place(s) of manufacture

Referenz/*Reference*
30008928

Yung-Li Co. Ltd.
Da Pu Industrial Zone, Cang Zi
Chang Ping Town
523571 DONG GUAN CITY
Guangdong
CHINA

VDE Prüf- und Zertifizierungsinstitut GmbH
VDE Testing and Certification Institute
Fachgebiet CC5
Section CC5

VDE Prüf- und Zertifizierungsinstitut Zeichengenehmigung

Ausweis-Nr. / Infoblatt /
Certificate No. / Info sheet
40026715

Name und Sitz des Genehmigungs-Inhabers / Name and registered seat of the Certificate holder

Yung-Li Co. Ltd., Da Pu Industrial Zone, Cang Zi, Chang Ping Town, 523571 DONG GUAN CITY, Guangdong, CHINA

Aktenzeichen / File ref.

1609800-5140-0012 / 203418 / CC5 / HEG

letzte Änderung / updated

2015-01-22

Datum / Date

2009-02-27

Dieses Blatt gilt nur in Verbindung mit Blatt 1 des Zeichengenehmigungsausweises Nr. 40026715.

This supplement is only valid in conjunction with page 1 of the Certificate No. 40026715.

Genehmigung zum Benutzen des auf Seite 1 abgebildeten markenrechtlich geschützten Zeichens des VDE:

Grundlage für die Benutzung sind die Allgemeinen Geschäftsbedingungen (AGB) der VDE Prüf- und Zertifizierungsinstitut GmbH (www.vde.com\AGB-Institut). Das Recht zur Benutzung erstreckt sich nur auf die bezeichnete Firma mit den genannten Fertigungsstätten und die oben aufgeführten Produkte mit den zugeordneten Bezeichnungen. Die Fertigungsstätte muss so eingerichtet sein, dass eine gleichmäßige Herstellung der geprüften und zertifizierten Ausführung gewährleistet ist.

Die Genehmigung ist so lange gültig wie die VDE-Bestimmungen gelten, die der Zertifizierung zugrunde gelegen haben, sofern sie nicht auf Grund anderer Bedingungen aus der VDE Prüf- und Zertifizierungsordnung (PM102) zurückgezogen werden muss.

Der Gültigkeitszeitraum einer VDE-GS-Zeichengenehmigung kann auf Antrag verlängert werden. Bei gesetzlichen und / oder normativen Änderungen kann die VDE-GS-Zeichengenehmigung ihre Gültigkeit zu einem früheren als dem angegebenen Datum verlieren.

Produkte, die das Biozid Dimethylfumarat (DMF) enthalten, dürfen gemäß der Kommissionsentscheidung 2009/251/EG nicht mehr in den Verkehr gebracht oder auf dem Markt bereitgestellt werden.

Der VDE-Zeichengenehmigungsausweis wird ausschließlich auf der ersten Seite unterzeichnet.

Approval to use the legally protected Mark of the VDE as shown on the first page:

Basis for the use are the general terms and conditions of the VDE Testing and Certification Institute (www.vde.com\terms-institute). The right to use the mark is granted only to the mentioned company with the named places of manufacture and the listed products with the related type references. The place of manufacture shall be equipped in a way that a constant manufacturing of the certified construction is assured.

The approval is valid as long as the VDE specifications are in force, on which the certification is based on, unless it is withdrawn according to the VDE Testing and Certification Procedure (PM102E).

The validity period of a VDE-GS-Mark Approval may be prolonged on request. In case of changes in legal and / or normative requirements, the validity period of a VDE-GS-Mark Approval may be shortened.

Products containing the biocide dimethylfumarate (DMF) may not be marketed or made available on the EC market according to the Commission Decision 2009/251/EC.

The approval is solely signed on the first page.

適合同等証明書

Statement of Conformity Assessment

電気用品安全法第8条第1項に規定する技術基準及び同法第9条第2項の経済産業省令で定める基準（法第9条第1項第2号に係る検査に係るものに限る）に適合していることを証明します

I hereby certify that the product mentioned below complies with the technical requirements stipulated in Paragraph 1 of Article 8 of Electrical Appliances and Materials Safety Act (here under referred to as the Act) and the requirements defined by the ordinance of the Ministry of Economy, Trade and Industry based on Paragraph 2 of Article 9 of the Act (limited to Item 2 of Paragraph 1 of Article 9 for Inspection of the Act).

1. 証明書番号: JET5087-12009-1002
Statement Number
2. 交付年月日: 2019年3月24日
Effective Date March 24, 2019
3. 有効年月日: 2026年3月23日
Date of Validity March 23, 2026
4. 申込者名 (Applicant)
住 所: DAPU INDUSTRIAL ZONE, GANGZI, CHANGPING TOWN,
Address DONGGUAN CITY, GUANGDONG PROVINCE, CHINA

氏名又は名称: YUNG LI CO., LTD.
Name

5. 特定電気用品名: キャブタイヤコード
Name of Product Sheathed flexible cords
6. 型式の区分: 別紙のとおり
Type Classification See attached "Type Classification"
7. 製造工場名 (Manufacturer)
住 所: DAPU INDUSTRIAL ZONE, GANGZI, CHANGPING TOWN,
Address DONGGUAN CITY, GUANGDONG PROVINCE, CHINA

氏名又は名称: YUNG LI CO., LTD.
Name

8. 適用試験規格: 電気用品の技術上の基準を定める省令の解釈
Applied Standard for Testing Description of the technical requirements by the METI Ordinance
別表第一 1 (1), (6) 及び (9)

Appendix 1 Section 1, (1), (6) and (9)

9. 適合性検査の方法: (Testing Method for Conformity Assessment)
 - 1) 試験用の特定電気用品については、電気用品の技術上の基準を定める省令の解釈に定める方法
With respect to testing for Category A products, the testing method is based on the technical requirements of the description of Electrical Appliances and Materials stipulated in the METI Ordinance.
 - 2) 当該特定電気用品に係る届出事業者又は事業場における検査設備については、電気用品安全法施行規則別表第四の検査設備の欄に掲げる検査設備ごとにそれぞれ同表の技術上の基準の欄に掲げる方法
With respect to inspection facilities required for Category A products at the factory, Testing Method described in the column of the technical requirements for each inspection facilities in the column of inspection facilities is shown in the Appendix 4 of Enforcement Regulations of the Act.

10. 注意事項

- 1) この適合同等証明書は、提出された試験用の電気用品に関して評価を行った上で交付したものであり、同一の型式の区分にある電気用品について電気用品安全法第8条1項に規定する技術基準適合確認の義務を履行したことを示すものではありません。

This Statement of Conformity Assessment, which is issued on the evaluation of the submitted test-use Electrical Appliances and Materials, does not signify that the Obligation to Comply with Requirements, which is prescribed at Paragraph 1 of Article 8 of the Act, is fulfilled on Electrical Appliances and Materials in the same Type Classification.

- 2) この適合同等証明書は、別紙に記載されている型式の区分の範囲内及び区分の組み合わせについてのみに有効です。

This Statement of Conformity Assessment is valid only for Electrical Appliances and Materials within the Type Classifications and their combination as stated in the attached "Type Classification".

一般財団法人 電気安全環境研究所
Japan Electrical Safety & Environment Technology Laboratories (JET)

理事長 薦田 康久
President Yasuhisa Komoda

東京都渋谷区代々木5-14-12
(5-14-12, Yoyogi, Shibuya-ku, Tokyo, Japan)

証明書番号 : J E T 5 0 8 7 - 1 2 0 0 9 - 1 0 0 2

適合同等証明書別紙

Statement of Conformity Assessment

型式の区分

Type Classification

要素 Factor	区分 Classification
絶縁体の主材料 Insulation materials	(2) 耐熱性ビニル混合物のもの Heat resistant polyvinyl chloride
外装の主材料 Sheath materials	(2) 耐熱性ビニル混合物のもの Heat resistant polyvinyl chloride
導体の種類 Conductor type	(1) A種のもの Type A
線心の構造 Core structure	(1) 同一のもの Same
耐震性 Vibration resistance	(2) ないもの Not vibration resistant
金属製の導体補強線 Metal messenger wires	(2) ないもの Without metal messenger wires

証明書番号 : J E T 5 0 8 7 - 1 2 0 0 9 - 1 0 0 2