

# 東莞永力電業有限公司

YUNG LI CO., LTD

Da Pu Industrial Zone, Gang Zi, Changping Town,  
Dong Guan City, Guangdong 523571 China.P.R.C

TEL:0769-83396797~8

FAX:0769-83396796

E-mail: sales@yung-li.com

Description: YP-32/YC-12

Customer: SIGNAL+POWER

Parts No.: GPC-3212-XXYYY

Draw No.:

## REVISION RECORD

1		
2		
3		
4		
5		

YUNG LI	
CHECKED	PREPARED BY

CUSTOMER	APPROVED

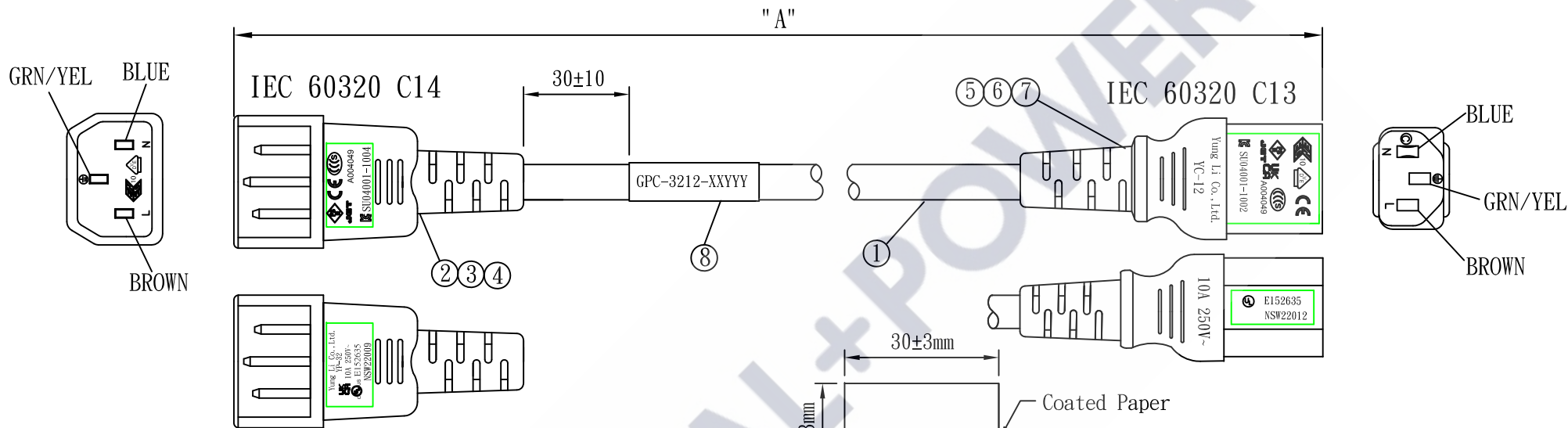

LENGTH: "A"	2FT	3FT	4FT	5FT	6FT	6.56FT
	610±30	915±30	1220±50	1530±50	1830±50	2000±50
P/N BLACK	GPC-3212-02BLK	GPC-3212-03BLK	GPC-3212-04BLK	GPC-3212-05BLK	GPC-3212-06BLK	GPC-3212-066BLK
P/N WHITE(RAL9010)	GPC-3212-02WHT	GPC-3212-03WHT	GPC-3212-04WHT	GPC-3212-05WHT	GPC-3212-06WHT	GPC-3212-066WHT
P/N RED(GY-49)	GPC-3212-02RED	GPC-3212-03RED	GPC-3212-04RED	GPC-3212-05RED	GPC-3212-06RED	GPC-3212-066RED
P/N BLUE(PT293C)	GPC-3212-02BLU	GPC-3212-03BLU	GPC-3212-04BLU	GPC-3212-05BLU	GPC-3212-06BLU	GPC-3212-066BLU

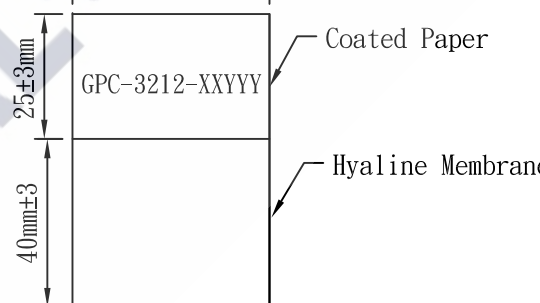

Sample Drawing No.:  
SP210510-06

Packing: Bundled to ease installation.

MARKING:

Yung Li Co., Ltd. H05VV-F 3G 1.0mm<sup>2</sup> <VDE> CE SAA-190646-EA SU01027-4002  
 A004049 60227 IEC 53(RVV) 300/500V c(UL)us E241374 SJT 3/C 17AWG(1.04mm<sup>2</sup>)  
 105°C 300V VW-1 <P>E JET HVCTF 3X1.25mm<sup>2</sup> ㄱ1ㄱ2 -F-

NO.	SPECIFICATION	QTY	REMARK
1	PSE HVCTF 1.25/3C+H05VV-F 1.0/3C+SJT 17/3C	1PC	
2	YP-32 PVC PLASTIC:50P	15g/PC	
3	TER:98672BS-1	3PCS	
4	INNER BODY: 2X4	1PC	
5	TER:97740	3PCS	
6	YC-12 INNER BODY	1PC	
7	YC-12 PVC PLASTIC:50P	18g/PC	
8	LABEL: (40+25)*50mm	1PC	

Tolerance >0±0.30 >1.0±0.50 >10.0±1.0 >20.0±2.0 Angle: ±1°	Approved	Date	SIGNAL+POWER			
	Checked		Date			
Drawn	SUKI	Date	21.05.10	Customer		
Cat. No.	YP-32/YC-12			P/N.	GPC-3212-XXYYY	
Drawing No.	Rev.	B	Material	P. V. C	Unit	mm
			Scale			

SU04001-1004



NSW22009

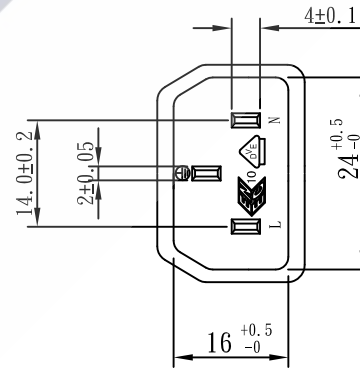
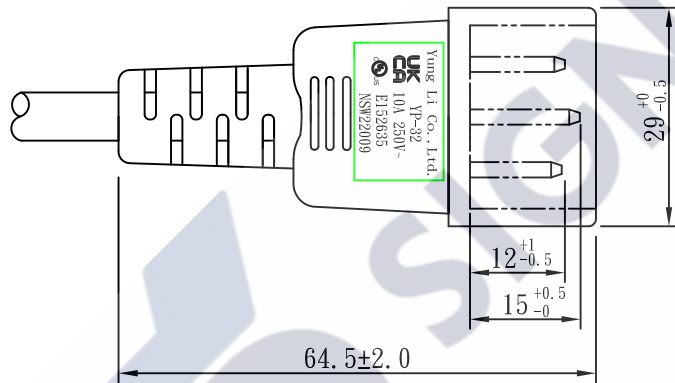
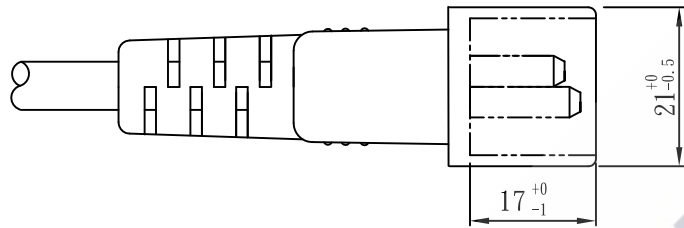
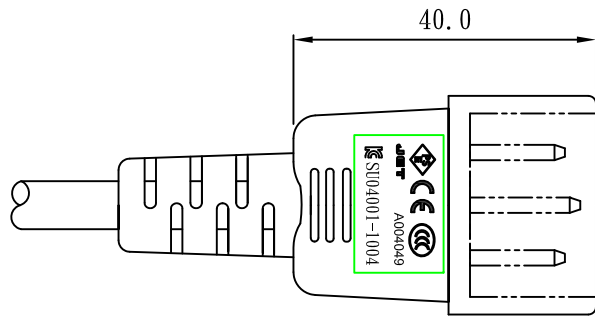

TOLERANCE >0 ± 0.30 >1.0 ± 0.50 >10.0 ± 1.0 >20.0 ± 2.0 Angle: ±1°	APPROVED		DATE		YUNG LI CO., LTD			
	CHECKED		DATE					
	DRAWN		DATE		CUSTOMER			
	TYPE	YP-32			P/N			
	DRAWING NO.		REV	B	MATERIAL	P. V. C	UNIT	mm
				SCALE	1:1			

K  
SU04001-1002



NSW22012

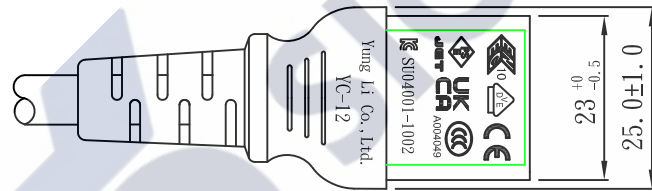
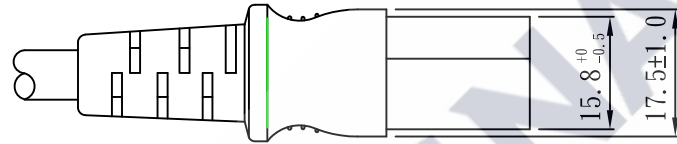
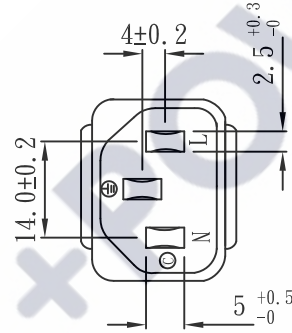
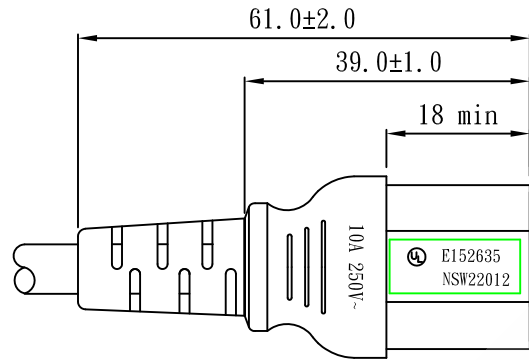

TOLERANCE >0±0.30 >1.0±0.50 >10.0±1.0 >20.0±2.0 Angle: ±1°	APPROVED		DATE		YUNG LI CO., LTD			
	CHECKED		DATE					
	DRAWN		DATE					
	TYPE	YC-12			P/N			
	DRAWING NO.		REV	B	SCALE	1:1	UNIT	mm

# YUNG LI CO., LTD

## SPECIFICATION

Yung-Li	Style	PVC FLEXIBLE CORDS	Document No
2019.08.23			V01244
Edition	Size	H05VV-F 3G 1.0 / SJT 17X3C/ HVCTF 3x1.25	Page
A			1/2

1. Standard: IEC 60227 IEC 60228 & UL 62 UL 1581 & JIS C3306

### 2. Construction & Dimension

Item		Specification
Conductor	Size	17AWG
	Material	Annealed Bare Copper
	Construction	32/ $\phi$ 0.18 $\pm$ 0.002
Insulation	Material	PVC
	Minimum Average Thickness	0.76mm
	Minimum Thickness at any point	0.69mm
	Diameter	3 $\pm$ 0.05
	Identification	Blue,Brown,Yellow/Green
Core Assembly	Core Twist	3-Core
	Filler	NA
	Assembly Pair	NA
Taping	Mylar Foil	NA
Shielded	A1-Mylar Foil	NA
Drain Wire	Material	NA
	Construction	NA
Jacket	Material	NA
	Minimum Average Thickness	0.9mm
	Minimum Thickness at any point	0.7mm
	Overall Diameter(Approx)	8.4 $\pm$ 0.1
	Color	Any Color

### MARKING:

Yung Li Co., Ltd. H05VV-F 3G 1.0mm<sup>2</sup> <VDE>  SAA-190646-EA  SU01027-4002

 A004049 60227 IEC 53(RVV) 300/500V c(UL)us E241374 SJT 3/C 17AWG(1.04mm<sup>2</sup>) 105°C

300V VW-1 <PS>E JET HVCTF 3X1.25mm<sup>2</sup>     -F-

# YUNG LI CO., LTD

## SPECIFICATION

Yung-Li	Style	PVC FLEXIBLE CORDS	Document No
2019.08.23			V01244
Edition	Size	H05VV-F 3G 1.0 / SJT 17X3C/ HVCTF 3x1.25	Page
A			2/2

3.Electrical & Physical Properties			
Item		Specification	
Rating Voltage		300V	
Maximum Temperature Rating		105°C	
Conductor resistance(AT 20°C)		19.1 Ω/Km MAX	
Insulation Resistance(AT 70°C)		0.010MΩ/Km Min	
Dielectric Strength		AC 2.0 KV / 15 min No Break	
Spark Test		5.0KV	
Insulation	Unaged	Tensile Strength	1.02 kgf/mm <sup>2</sup> min
		Elongation	150% Min
	Aged	Tensile Strength	Min 85%(136±1°C x168hrs)
		Elongation	Min 65%(136±1°C x168hrs)
Jacket	Unaged	Tensile Strength	1.02 kgf/mm <sup>2</sup> min
		Elongation	150% Min
	Aged	Tensile Strength	Min 85%(136±1°C x168hrs)
		Elongation	Min 45%(136±1°C x168hrs)
Deformation Test		70±4°C X 1hr ≤ 50%	
Cold Bend Test		-20°C x 4hr No Crack	
Heat Shock Test		150±2°C x 1hr No Crack	

### Graph:

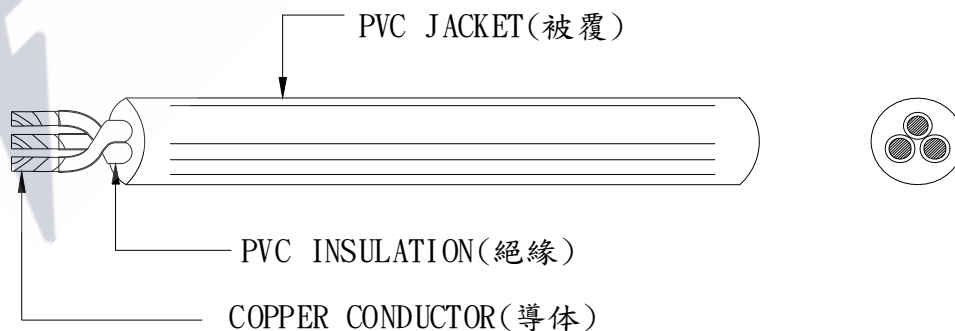

# ELBZ7.E152635 - Cord Sets and Power-supply Cords Certified for Canada

## Cord Sets and Power-supply Cords Certified for Canada

See General Information for Cord Sets and Power-supply Cords Certified for Canada

### YUNG LI CO LTD

7F-12 NO 99 SEC 1 XINTAI 5TH RD  
XIZHI DISTRICT  
NEW TAIPEI, 22175 TAIWAN

### Power-supply cords

E152635

Cat. No.	ANSI/NEMA WD6 Config	Cord AWG	Cord Type	Electrical Rating Amps V
YP-11	1-15	18/2	SPT-1, SPT-2, SPT-3, NISPT-2, SVT, SVTO, SJT, SJTW, SJTO, SJTOW (All TPE material), SPT-1, SPT-1W, NISPT-1, SPT-2, SPT-2W, NISPT-2, SPT-3, HPN, SVT, SVTO, SJT, SJTW, SJTO, SJTOW, SV, SVO, SJ, SJO, SJOW, SJOOW, EVT, EVJT, EVE, EVJE	7 or 10/125
		17/2	SVT, SVTO (All TPE material), SVT, SVTO, SV, SVO, SJ, SJO, SJOW, SJOOW, EVT, EVJT, EVE, EVJE	12/125
		16/2	SPT-2, SPT-3, NISPT-2, SVT, SVTO, SJT, SJTW, SJTO, SJTOW (All TPE material), SPT-2, SPT-2W, NISPT-2, SPT-3, SVT, SVTO, SJT, SJTW, SJTO, SJTOW, SV, SVO, SJ, SJO, SJOW, SJOOW, EVT, EVJT, EVE, EVJE	13/125
		16/2	HPN	15/125
		14/2	SPT-3, SJT, SJTW, SJTO, SJTOW (All TPE material), SPT-3, SJT, SJTW, SJTO, SJTOW, SJ, SJO, SJOW, SJOOW, EVT, EVJT, EVE, EVJE	15/125
YP-11W	1-15P	18/2	SPT-1, SPT-2, SPT-3, NISPT-2, SVT, SVTO, SJT, SJTW, SJTO, SJTOW (All TPE material), SPT-1, SPT-1W, NISPT-1, SPT-2, SPT-2W, NISPT-2, SPT-3, HPN, SVT, SVTO, SJT, SJTW, , SJTO, SJTOW, SV, SVO, SJ, SJO, SJOW, SJOOW, EVT, EVJT, EVE, EVJE	7 or 10/125
		17/2	SVT, SVTO (All TPE material), SVT, SVTO, SV, SVO, SJ, SJO, SJOW, SJOOW, EVT, EVJT, EVE, EVJE	12/125
		16/2	SPT-2, SPT-3, NISPT-2, SVT, SVTO, SJT, SJTW, SJTO, SJTOW (All TPE material), SPT-2, SPT-2W, NISPT-2, SPT-3, SVT, SVTO, SJT, SJTW, SJTO, SJTOW, SV, SVO, SJ, SJO, SJOW, SJOOW, EVT, EVJT, EVE, EVJE	13/125
		16/2	HPN	15/125
		14/2	SPT-3, SJT, SJTW, SJTO, SJTOW (All TPE material), SPT-3, SJT, SJTW, SJTO, SJTOW, SJ, SJO, SJOW, SJOOW, EVT, EVJT, EVE, EVJE	15/125

		14/3	SJT, SJTW, SJTO, SJTOW, ST, STW, STOW, SPT-3 (All TPE material), SJT, SJTW, SJTO, SJTOW, ST, STW, STOW, SO, SOW, SOOW, SPT-3, EVT, EVJT, EVE, EVJE	15/250
		12/3	SJT, SJTW, SJTO, SJTOW, ST, STW, STOW, SPT-3 (All TPE material), SJT, SJTW, SJTO, SJTOW, ST, STW, STOW, SO, SOW, SOOW, SPT-3, EVT, EVJT, EVE, EVJE	15/250
YP-31	IEC C8	18/2	SVT, SVTO, SJT, SJTW, SJTO, SJTOW, SPT-1, SPT-2, NISPT-2 (All TPE material), SVT, SVTO, SJT, SJTW, SJTO, SJTOW, SV, SVO, SJ, SJO, SJOW, SJOOW, SPT-1, SPT-1W, SPT-2, SPT-2W, NISPT-1, NISPT-2, EVT, EVJT, EVE, EVJE	7/125, 2.5/250
YP-32, YP-32L, YP-32L-1, YP-32L-2, YP-32L-3	IEC C14	18/3	SVT, SJT, SJTW, SJTO, SJTOW, ST, STW, STOW (All TPE material, Shielded and Non-shielded for all types), SVT, SJT, SJTW, SJTO, SJTOW, ST, STW, STOW, SJ, SJO, SJO, SJOW, SJOOW, SO, SOO, SOW, SOOW (Shielded or Non-shielded for all types), EVT, EVJT, EVE, EVJE	2.5, 7 or 10/125 or 250
		17/3	SVT, SJT, SJTW, SJTO, SJTOW, ST, STW, STOW (All TPE material, Shielded and Non-shielded for all types), SVT, SJT, SJTW, SJTO, SJTOW, ST, STW, STOW, SJ, SJO, SJO, SJOW, SJOOW, SO, SOO, SOW, SOOW (Shielded or Non-shielded for all types), EVT, EVJT, EVE, EVJE	10, 12/125 or 250
		16/3	SJT, SJTW, SJTO, SJTOW, ST, STW, STOW (All TPE material, Shielded and Non-shielded for all types), SJT, SJTW, SJTO, SJTOW, ST, STW, STOW, SJ, SJO, SJO, SJOW, SJOOW, SO, SOO, SOW, SOOW (Shielded or Non-shielded for all types), EVT, EVJT, EVE, EVJE	13/125 or 250
		15/3	SJT, SJTW, SJTO, SJTOW, ST, STW, STOW (All TPE material, Shielded and Non-shielded for all types), SJT, SJTW, SJTO, SJTOW, ST, STW, STOW, SJ, SJO, SJO, SJOW, SJOOW, SO, SOO, SOW, SOOW (Shielded or Non-shielded for all types), EVT, EVJT, EVE, EVJE	14/125 or 250
		14/3	SJT, SJTW, SJTO, SJTOW, ST, STW, STOW (All TPE material, Shielded and Non-shielded for all types), SJT, SJTW, SJTO, SJTOW, ST, STW, STOW, SJ, SJO, SJO, SJOW, SJOOW, SO, SOO, SOW, SOOW (Shielded or Non-shielded for all types), EVT, EVJT, EVE, EVJE	15/125 or 250
YP-12D	5-15	18/3	SVT, SJT, SJT Shielded, SJTW, SJTO, SJTOW (All TPE material), SVT, SJT, SJT Shielded, SJTW, SJTO, SJTOW, EVT, EVJT, EVE, EVJE	7 or 10/125
		16/3	SVT, SJT, SJT Shielded, SJTW, SJTO, SJTOW (All TPE material), SVT, SJT, SJT Shielded, SJTW, SJTO, SJTOW, EVT, EVJT, EVE, EVJE	13/125
		14/3	SVT, SJT, SJT Shielded, SJTW, SJTO, SJTOW (All TPE material), SVT, SJT, SJT Shielded, SJTW, SJTO, SJTOW, EVT, EVJT, EVE, EVJE	15/125
YP-32A	IEC C14	18/3	SVT, SJT, SJT Shielded, SJTW, SJTO, SJTOW (All TPE material), SVT, SJT, SJT Shielded, SJTW, SJTO, SJTOW, EVT, EVJT, EVE, EVJE	2.5, 7 or 10/250
		16/3	SVT, SJT, SJT Shielded, SJTW, SJTO, SJTOW (All TPE material), SVT, SJT, SJT Shielded, SJTW, SJTO, SJTOW, EVT, EVJT, EVE, EVJE	13/250



		8/3	S, SO, SOW, SOO, SOOW, ST, STW, STO, STOW, STOO, STOOW	30/277 Vac
YP-12R, YP-12R-1	5-15P	18/3	SJ, SJO, SJOW, SJOO, SJOOW, S, SO, SOW, SOO, SOOW, SVT, SVTO, SJT, SJTW, SJTO, SJTOW, SJTOO, SJTOOW, ST, STW, STO, STOW, STOO, STOOW	10/125
		16/3	SJ, SJO, SJOW, SJOO, SJOOW, S, SO, SOW, SOO, SOOW, SJT, SJTW, SJTO, SJTOW, SJTOO, SJTOOW, ST, STW, STO, STOW, STOO, STOOW	13/125
		14/3	SJ, SJO, SJOW, SJOO, SJOOW, S, SO, SOW, SOO, SOOW, SJT, SJTW, SJTO, SJTOW, SJTOO, SJTOOW, ST, STW, STO, STOW, STOO, STOOW	15/125
		12/3	SJ, SJO, SJOW, SJOO, SJOOW, SJT, SJTW, SJTO, SJTOW, SJTOO, SJTOOW	15/125

**Special-use cord sets**

Cat. No.	IEC 320 Cord Config AWG	Cord Type	Electrical Rating Amps V	
YC-11	IEC C17	18	SPT-1, SPT-2, SPT-3, NISPT-2, SVT, SJT, SJTO, SJTOW, ST, STW, STOW (All TPE material), SPT-1, SPT-2, NISPT-1, NISPT-2, SPT-3, SVT, SJT, SJTO, SJTW, SJTOW, ST, STW, STOW, SO, SOW, SOOW	2.5, 7 or 10/125 or 250
		17	SPT-3, SVT, SJT, SJTW, SJTO, SJTOW, ST, STW, STOW (All TPE material), SPT-3, SVT, SJT, SJTW, SJTO, SJTOW, ST, STW, STOW, SO, SOW, SOOW	10, 12/125 or 250
		16	SPT-2, SPT-3, NISPT-2, SVT, SJT, SJTW, SJTO, SJTOW, ST, STW, STOW (All TPE material), SPT-2, NISPT-2, SPT-3, SVT, SJT, SJTW, SJTO, SJTOW, ST, STW, STOW, SO, SOW, SOOW	13/125 or 250
YC-12, YC-12L, YC-12L-1, YC-12L-2, YC-12L-3	IEC C13	18	SVT, SJT, SJTW, SJTO, SJTOW, ST, STW, STOW (Shielded and Non-shielded for all types), SPT-2, SPT-3 (All TPE material), SVT, SJT, SJTW, SJTO, SJTOW, SJ, SJO, SJOO, SJOW, SJOOW, ST, STW, STOW, SO, SOO, SOW, SOOW (Shielded or Non-Shielded for above types), SPT-2, SPT-3	2.5, 7 or 10/125 or 250
		17	SVT, SJT, SJTW, SJTO, SJTOW, ST, STW, STOW (Shielded and Non-shielded for all types), SPT-3 (All TPE material), SVT, SJT, SJTW, SJTO, SJTOW, ST, STW, STOW, SJ, SJO, SJOO, SJOW, SJOOW, SO, SOO, SOW, SOOW (Shielded or Non-shielded for above types), SPT-3	10, 12/125 or 250
		16	SJT, SJTW, SJTO, SJTOW, ST, STW, STOW (Shielded and Non-shielded for all types), SPT-3 (All TPE material), SJT, SJTW, SJTO, SJTOW, ST, STW, STOW, SJ, SJO, SJOO, SJOW, SJOOW, SO, SOO, SOW, SOOW (Shielded or Non-shielded for above types), SPT-2, SPT-3	13/125 or 250
		15	SJT, SJTW, SJTO, SJTOW, ST, STW, STOW (Shielded and Non-shielded for all types), SPT-3 (All TPE material), SJT, SJTW, SJTO, SJTOW, ST, STW, STOW, SJ, SJO, SJOO, SJOW, SJOOW, SO, SOO, SOW, SOOW (Shielded or Non-shielded for above types), SPT-3	10, 14/125 or 250

		14	SJT, SJTW, SJTO, SJTOW, ST, STW, STOW (Shielded and Non-shielded for all types), SPT-3 (All TPE material), SJT, SJTW, SJTO, SJTOW, ST, STW, STOW, SJ, SJO, SJOO, SJOW, SJOOW, SO, SOO, SOW, SOOW (Shielded or Non-shielded for above types), SPT-3	15/125 or 250
		12	SJT, SJTW, SJTO, SJTOW, ST, STW, STOW (All TPE material, Shielded and Non-shielded for all types), SJT, SJTW, SJTO, SJTOW, ST, STW, STOW, SJ, SJO, SJOO, SJOW, SJOOW, SO, SOO, SOW, SOOW (Shielded or Non-shielded for all types)	15/125 or 250
YC-12(A.C.1)	IEC C13	12	SJT, SJTW, SJTO, SJTOW, ST, STW, STOW, SPT-3 (All TPE material), SJT, SJTW, SJTO, SJTOW, ST, STW, STOW, SO, SOW, SOOW, SPT-3	15/125 or 250
		10	SJT, SJTW, SJTO, SJTOW, ST, STW, STOW (All TPE material), SJT, SJTW, SJTO, SJTOW, ST, STW, STOW, SO, SOW, SOOW	15/125 or 250
YC-12C	IEC C13	18	NISPT-2 (TPE), NISPT-2	2.5, 7 or 10/125 or 250
		16	NISPT-2 (TPE), NISPT-2	13/125 or 250
YC-13	IEC C7	18	SPT-1, SPT-2, NISPT-2, SVT, SJT (All TPE material), SPT-1, SPT-1W, SPT-2, SPT-2W, NISPT-1, NISPT-2, SVT, SJT	2.5/250 or 7/125
YC-13W	IEC C7P	18	SPT-1, SPT-2, NISPT-2, SVT, SJT (All TPE material), SPT-1, SPT-1W, SPT-2, SPT-2W, NISPT-1, NISPT-2, SVT, SJT	2.5/250 or 7/125
YC-14	IEC C5	18	SPT-2, SVT, SVT shielded, SVTO, SJT, SJT shielded, SJTW, SJTW shielded, SJTO, SJTOW (All TPE material), SVT, SVT Shielded, SVTO, SJT, SJT Shielded, SJTW, SJTW Shielded, SJTO, SJTOW, SV, SVO, SJ, SJO, SJOW, SJOOW	2.5/250 or 7/125
			SPT-2	
YC-13L	IEC C7	18	SPT-1, SPT-2, NISPT-2, SVT, SJT (All TPE material), SPT-1, SPT-1W, SPT-2, SPT-2W, NISPT-1, NISPT-2, SVT, SJT	2.5/250 or 7/125
YC-13D	IEC C7	18	SPT-1, SPT-2, NISPT-2, SVT, SJT (All TPE material), SPT-1, SPT-1W, SPT-2, SPT-2W, NISPT-1, NISPT-2, SJT, SVT	2.5/250 or 7/125
YC-13C	IEC C7	18	NISPT-2 (All TPE material), NISPT-1, NISPT-2	2.5/250 or 7/125
YC-13E	IEC C7	18	SPT-1, SPT-2, NISPT-2, SVT, SJT (All TPE material), SPT-1, SPT-1W, SPT-2, SPT-2W, NISPT-1, NISPT-2, SVT, SJT	2.5/250 or 7/125
YC-14L, YC-14L-1, YC-14L-2, YC-14L-3	IEC C5	18	SVT, SJT, SPT-2 (All TPE material), SVT, SJT, SPT-2	2.5/250 or 7/125
YC-18	IEC C19	16	SJT, SJTW, SJTO, SJTOW, SJTOOW, ST, STW, STOW, STOOW, SPT-3 (All TPE material), SJT, SJTW, SJTO, SJTOW, SJTOOW, SJ, SJO, SJOO, SJOW, SJOOW, ST, STW, STOW, STOOW, S, SO, SOW, SOO, SOOW, SPT-3	13/125 or 250

## ZEICHENGENEHMIGUNG MARKS APPROVAL

Yung-Li Co. Ltd.  
Da Pu Industrial Zone, Cang Zi  
Chang Ping Town  
523571 DONG GUAN CITY  
Guangdong  
CHINA

ist berechtigt, für ihr Produkt /  
*is authorized to use for their product*

**Geräteanschlußstecker, nichtwiederanschließbar**  
**Plug connector, non-rewirable**

die hier abgebildeten markenrechtlich geschützten Zeichen  
für die ab Blatt 2 aufgeführten Typen zu benutzen /  
*the legally protected Marks as shown below for the types referred to on page 2 ff.*



Geprüft und zertifiziert nach /  
*Tested and certified according to*

DIN EN 60320-1 (VDE 0625-1):2016-04; EN 60320-1:2015+AC:2016  
DIN EN 60320-3 (VDE 0625-3):2015-11; EN 60320-3:2014  
IEC 60320-1:2015  
IEC 60320-3:2014

Aktenzeichen: 1609800-1550-0004 / 232788

File ref.:

Ausweis-Nr. 40029462

Blatt 1

Certificate No.

Page

Weitere Bedingungen siehe Rückseite und Folgeblätter /  
*further conditions see overleaf and following pages*

Offenbach, 2010-02-19

(letzte Änderung / updated 2017-07-17 )

VDE Prüf- und Zertifizierungsinstitut GmbH  
VDE Testing and Certification Institute  
Zertifizierungsstelle / Certification

R. Nickel

VDE Zertifikate sind nur gültig bei Veröffentlichung unter:  
*VDE certificates are valid only when published on:*

<http://www.vde.com/zertifikat>  
<http://www.vde.com/certificate>

Name und Sitz des Genehmigungs-Inhabers / *Name and registered seat of the Certificate holder*

Yung-Li Co. Ltd., Da Pu Industrial Zone, Cang Zi, Chang Ping Town, 523571 DONG GUAN CITY, Guangdong, CHINA

Aktenzeichen / *File ref.*

1609800-1550-0004 / 232788 / CC1 / E

letzte Änderung / *updated*

2017-07-17

Datum / *Date*

2010-02-19

Dieses Blatt gilt nur in Verbindung mit Blatt 1 des Zeichengenehmigungsausweises Nr. 40029462.

*This supplement is only valid in conjunction with page 1 of the Certificate No. 40029462.*

## Geräteanschlußstecker, nichtwiederanschließbar *Plug connector, non-rewirable*

Typ(en) / *Type(s)*

- 1) YP-32
- 2) YP-32L

Bemessungsspannung  
*Rated voltage*

AC 250 V

Bemessungsstrom  
*Rated current*

10 A

Polzahl  
*Number of poles*

2-polig mit Schutzkontakt  
*2-pole with earthing contact*

Bauart  
*Kind of construction*

Normblatt E  
*standard sheet E*

Ausführung(en)  
*Construction(s)*

zentrale Leitungseinführung  
*straight cable entry*  
Für / for 1)

abgewinkelte Leitungseinführung  
*angled cable entry*  
Für / for 2)

Warenzeicheninhaber  
*Trademark holder*

Yung-Li Co. Ltd.

Produktinformation  
*Product information*

siehe Anlage Nr. 300 + 700 + 900 vom 2017-07-17  
*see Appendix No. 300 + 700 + 900 dated 2017-07-17*

Dieser Zeichengenehmigungs-Ausweis bildet eine Grundlage für die EG-Konformitätserklärung und CE-Kennzeichnung durch den Hersteller oder dessen Bevollmächtigten und bescheinigt die Konformität mit den grundlegenden Schutzanforderungen der **EG-Niederspannungsrichtlinie 2014/35/EU**.

*This Marks Approval is a basis for the EC Declaration of Conformity and the CE Marking by the manufacturer or his agent and proves the conformity with the essential safety requirements of the **EC Low-Voltage Directive 2014/35/EU**.*

Fortsetzung siehe Blatt 3 /  
*continued on page 3*

# VDE Prüf- und Zertifizierungsinstitut Zeichengenehmigung

Ausweis-Nr. / Blatt /  
Certificate No. / Page  
40029462 3

Name und Sitz des Genehmigungs-Inhabers / *Name and registered seat of the Certificate holder*

Yung-Li Co. Ltd., Da Pu Industrial Zone, Cang Zi, Chang Ping Town, 523571 DONG GUAN CITY, Guangdong, CHINA

Aktenzeichen / *File ref.*

1609800-1550-0004 / 232788 / CC1 / E

letzte Änderung / *updated*

2017-07-17

Datum / *Date*

2010-02-19

Dieses Blatt gilt nur in Verbindung mit Blatt 1 des Zeichengenehmigungsausweises Nr. 40029462.

*This supplement is only valid in conjunction with page 1 of the Certificate No. 40029462.*

VDE Prüf- und Zertifizierungsinstitut GmbH

*VDE Testing and Certification Institute*

Fachgebiet CC1

*Section CC1*



# VDE Prüf- und Zertifizierungsinstitut Zeichengenehmigung

Ausweis-Nr. / Beiblatt /  
Certificate No. Supplement  
40029462

Name und Sitz des Genehmigungs-Inhabers / *Name and registered seat of the Certificate holder*

Yung-Li Co. Ltd., Da Pu Industrial Zone, Cang Zi, Chang Ping Town, 523571 DONG GUAN CITY, Guangdong, CHINA

Aktenzeichen / *File ref.*

1609800-1550-0004 / 232788 / CC1 / E

letzte Änderung / *updated*

2017-07-17

Datum / *Date*

2010-02-19

Dieses Beiblatt ist Bestandteil des Zeichengenehmigungsausweises Nr. 40029462.

*This supplement is part of the Certificate No. 40029462.*

## Geräteanschlußstecker, nichtwiederanschließbar *Plug connector, non-rewirable*

### Fertigungsstätte(n)

*Place(s) of manufacture*

Referenz/*Reference*  
**30008928**

Yung-Li Co. Ltd.  
Da Pu Industrial Zone, Cang Zi  
Chang Ping Town  
523571 DONG GUAN CITY  
Guangdong  
CHINA

VDE Prüf- und Zertifizierungsinstitut GmbH

*VDE Testing and Certification Institute*

Fachgebiet CC1

*Section CC1*

Name und Sitz des Genehmigungs-Inhabers / *Name and registered seat of the Certificate holder*

Yung-Li Co. Ltd., Da Pu Industrial Zone, Cang Zi, Chang Ping Town, 523571 DONG GUAN CITY, Guangdong, CHINA

Aktenzeichen / *File ref.*

1609800-1550-0004 / 232788 / CC1 / E

letzte Änderung / *updated*

2017-07-17

Datum / *Date*

2010-02-19

Dieses Blatt gilt nur in Verbindung mit Blatt 1 des Zeichengenehmigungsausweises Nr. 40029462.

*This supplement is only valid in conjunction with page 1 of the Certificate No. 40029462.*

## **Genehmigung zum Benutzen des auf Seite 1 abgebildeten markenrechtlich geschützten Zeichens des VDE:**

Grundlage für die Benutzung sind die Allgemeinen Geschäftsbedingungen (AGB) der VDE Prüf- und Zertifizierungsinstitut GmbH ([www.vde.com\AGB-Institut](http://www.vde.com\AGB-Institut)). Das Recht zur Benutzung erstreckt sich nur auf die bezeichnete Firma mit den genannten Fertigungsstätten und die oben aufgeführten Produkte mit den zugeordneten Bezeichnungen. Die Fertigungsstätte muss so eingerichtet sein, dass eine gleichmäßige Herstellung der geprüften und zertifizierten Ausführung gewährleistet ist.

Die Genehmigung ist so lange gültig wie die VDE-Bestimmungen gelten, die der Zertifizierung zugrunde gelegen haben, sofern sie nicht auf Grund anderer Bedingungen aus der VDE Prüf- und Zertifizierungsordnung (PM102) zurückgezogen werden muss.

Der Gültigkeitszeitraum einer VDE-GS-Zeichengenehmigung kann auf Antrag verlängert werden. Bei gesetzlichen und / oder normativen Änderungen kann die VDE-GS-Zeichengenehmigung ihre Gültigkeit zu einem früheren als dem angegebenen Datum verlieren.

Produkte, die das Biozid Dimethylfumarat (DMF) enthalten, dürfen gemäß der Kommissionsentscheidung 2009/251/EG nicht mehr in den Verkehr gebracht oder auf dem Markt bereitgestellt werden.

Der VDE-Zeichengenehmigungsausweis wird ausschließlich auf der ersten Seite unterzeichnet.

### **Approval to use the legally protected Mark of the VDE as shown on the first page:**

*Basis for the use are the general terms and conditions of the VDE Testing and Certification Institute ([www.vde.com\terms-institute](http://www.vde.com\terms-institute)). The right to use the mark is granted only to the mentioned company with the named places of manufacture and the listed products with the related type references. The place of manufacture shall be equipped in a way that a constant manufacturing of the certified construction is assured.*

*The approval is valid as long as the VDE specifications are in force, on which the certification is based on, unless it is withdrawn according to the VDE Testing and Certification Procedure (PM102E).*

*The validity period of a VDE-GS-Mark Approval may be prolonged on request. In case of changes in legal and / or normative requirements, the validity period of a VDE-GS-Mark Approval may be shortened.*

*Products containing the biocide dimethylfumarate (DMF) may not be marketed or made available on the EC market according to the Commission Decision 2009/251/EC.*

*The approval is solely signed on the first page.*

## ZEICHENGENEHMIGUNG MARKS APPROVAL

Yung-Li Co. Ltd.  
Da Pu Industrial Zone, Cang Zi  
Chang Ping Town  
523571 DONG GUAN CITY  
Guangdong  
CHINA

ist berechtigt, für ihr Produkt /  
*is authorized to use for their product*

**Gerätesteckdose, nicht-wiederanschließbar**  
**Connector, non-rewirable**

die hier abgebildeten markenrechtlich geschützten Zeichen  
für die ab Blatt 2 aufgeführten Typen zu benutzen /  
*the legally protected Marks as shown below for the types referred to on page 2 ff.*



Geprüft und zertifiziert nach /  
*Tested and certified according to*

DIN EN 60320-1 (VDE 0625-1):2016-04; EN 60320-1:2015+AC:2016  
DIN EN 60320-3 (VDE 0625-3):2015-11; EN 60320-3:2014  
IEC 60320-1:2015  
IEC 60320-3:2014

Aktenzeichen: 1609800-1550-0003 / 232784

File ref.:

Ausweis-Nr. 40029577

Blatt 1

Certificate No.

Page

Weitere Bedingungen siehe Rückseite und Folgeblätter /  
*further conditions see overleaf and following pages*

Offenbach, 2010-03-05

(letzte Änderung/updated 2017-12-13 )

VDE Prüf- und Zertifizierungsinstitut GmbH  
VDE Testing and Certification Institute  
Zertifizierungsstelle / Certification

G. Heine

VDE Zertifikate sind nur gültig bei Veröffentlichung unter:  
VDE certificates are valid only when published on:

<http://www.vde.com/zertifikat>  
<http://www.vde.com/certificate>



Name und Sitz des Genehmigungs-Inhabers / *Name and registered seat of the Certificate holder*

Yung-Li Co. Ltd., Da Pu Industrial Zone, Cang Zi, Chang Ping Town, 523571 DONG GUAN CITY, Guangdong, CHINA

Aktenzeichen / *File ref.*

1609800-1550-0003 / 232784 / TL3 / E

letzte Änderung / *updated*

2017-12-13

Datum / *Date*

2010-03-05

Dieses Blatt gilt nur in Verbindung mit Blatt 1 des Zeichengenehmigungsausweises Nr. 40029577.

*This supplement is only valid in conjunction with page 1 of the Certificate No. 40029577.*

## Gerätesteckdose, nicht-wiederanschließbar *Connector, non-rewirable*

Typ(en) / *Type(s)*

- 1) YC-12
- 2) YC-12L

Bemessungsspannung  
*Rated voltage*

AC 250 V

Bemessungsstrom  
*Rated current*

10 A

Polzahl  
*Number of poles*

2-polig mit Schutzkontakt  
*2-pole with earthing contact*

Bauart  
*Kind of construction*

Normblatt C13  
*standard sheet C13*

Ausführung(en)  
*Construction(s)*

zentrale Leitungseinführung  
*straight cable entry*  
Für / *for* 1)

abgewinkelte Leitungseinführung  
*angled cable entry*  
Für / *for* 2)

Warenzeicheninhaber  
*Trademark holder*

Yung Li Co. Ltd.

Produktinformation

siehe Anlage Nr. 300 + 700 + 702 + 703 + 900 vom 2017-11-02  
und  
Anlage Nr. 701 vom 2017-12-13

*Product information*

*see Appendix No. 300 + 700 + 702 + 703 + 900 dated  
2017-11-02  
and  
Appendix No. 701 dated 2017-12-13*

Fortsetzung siehe Blatt 3 /  
*continued on page 3*

# VDE Prüf- und Zertifizierungsinstitut Zeichengenehmigung

Ausweis-Nr. / Blatt /  
Certificate No. / Page  
40029577 3

Name und Sitz des Genehmigungs-Inhabers / *Name and registered seat of the Certificate holder*

Yung-Li Co. Ltd., Da Pu Industrial Zone, Cang Zi, Chang Ping Town, 523571 DONG GUAN CITY, Guangdong, CHINA

Aktenzeichen / *File ref.*

1609800-1550-0003 / 232784 / TL3 / E

letzte Änderung / *updated*

2017-12-13

Datum / *Date*

2010-03-05

Dieses Blatt gilt nur in Verbindung mit Blatt 1 des Zeichengenehmigungsausweises Nr. 40029577.

*This supplement is only valid in conjunction with page 1 of the Certificate No. 40029577.*

Dieser Zeichengenehmigungs-Ausweis bildet eine Grundlage für die EG-Konformitätserklärung und CE-Kennzeichnung durch den Hersteller oder dessen Bevollmächtigten und bescheinigt die Konformität mit den grundlegenden Schutzanforderungen der **EG-Niederspannungsrichtlinie 2014/35/EU**.

*This Marks Approval is a basis for the EC Declaration of Conformity and the CE Marking by the manufacturer or his agent and proves the conformity with the essential safety requirements of the **EC Low-Voltage Directive 2014/35/EU**.*

VDE Prüf- und Zertifizierungsinstitut GmbH

*VDE Testing and Certification Institute*

Fachgebiet TL3

*Section TL3*

Name und Sitz des Genehmigungs-Inhabers / *Name and registered seat of the Certificate holder*

Yung-Li Co. Ltd., Da Pu Industrial Zone, Cang Zi, Chang Ping Town, 523571 DONG GUAN CITY, Guangdong, CHINA

Aktenzeichen / *File ref.*

1609800-1550-0003 / 232784 / TL3 / E

letzte Änderung / *updated*

2017-12-13

Datum / *Date*

2010-03-05

Dieses Beiblatt ist Bestandteil des Zeichengenehmigungsausweises Nr. 40029577.

*This supplement is part of the Certificate No. 40029577.*

## Gerätesteckdose, nicht-wiederanschließbar *Connector, non-rewirable*

### Fertigungsstätte(n)

*Place(s) of manufacture*

Referenz/*Reference*  
**30008928**

Yung-Li Co. Ltd.  
Da Pu Industrial Zone, Cang Zi  
Chang Ping Town  
523571 DONG GUAN CITY  
Guangdong  
CHINA

VDE Prüf- und Zertifizierungsinstitut GmbH

*VDE Testing and Certification Institute*

Fachgebiet TL3

*Section TL3*

Name und Sitz des Genehmigungs-Inhabers / *Name and registered seat of the Certificate holder*

Yung-Li Co. Ltd., Da Pu Industrial Zone, Cang Zi, Chang Ping Town, 523571 DONG GUAN CITY, Guangdong, CHINA

Aktenzeichen / *File ref.*

1609800-1550-0003 / 232784 / TL3 / E

letzte Änderung / *updated*

2017-12-13

Datum / *Date*

2010-03-05

Dieses Blatt gilt nur in Verbindung mit Blatt 1 des Zeichengenehmigungsausweises Nr. 40029577.

*This supplement is only valid in conjunction with page 1 of the Certificate No. 40029577.*

## **Genehmigung zum Benutzen des auf Seite 1 abgebildeten markenrechtlich geschützten Zeichens des VDE:**

Grundlage für die Benutzung sind die Allgemeinen Geschäftsbedingungen (AGB) der VDE Prüf- und Zertifizierungsinstitut GmbH ([www.vde.com\AGB-Institut](http://www.vde.com\AGB-Institut)). Das Recht zur Benutzung erstreckt sich nur auf die bezeichnete Firma mit den genannten Fertigungsstätten und die oben aufgeführten Produkte mit den zugeordneten Bezeichnungen. Die Fertigungsstätte muss so eingerichtet sein, dass eine gleichmäßige Herstellung der geprüften und zertifizierten Ausführung gewährleistet ist.

Die Genehmigung ist so lange gültig wie die VDE-Bestimmungen gelten, die der Zertifizierung zugrunde gelegen haben, sofern sie nicht auf Grund anderer Bedingungen aus der VDE Prüf- und Zertifizierungsordnung (PM102) zurückgezogen werden muss.

Der Gültigkeitszeitraum einer VDE-GS-Zeichengenehmigung kann auf Antrag verlängert werden. Bei gesetzlichen und / oder normativen Änderungen kann die VDE-GS-Zeichengenehmigung ihre Gültigkeit zu einem früheren als dem angegebenen Datum verlieren.

Produkte, die das Biozid Dimethylfumarat (DMF) enthalten, dürfen gemäß der Kommissionsentscheidung 2009/251/EG nicht mehr in den Verkehr gebracht oder auf dem Markt bereitgestellt werden.

Der VDE-Zeichengenehmigungsausweis wird ausschließlich auf der ersten Seite unterzeichnet.

### **Approval to use the legally protected Mark of the VDE as shown on the first page:**

*Basis for the use are the general terms and conditions of the VDE Testing and Certification Institute ([www.vde.com\terms-institute](http://www.vde.com\terms-institute)). The right to use the mark is granted only to the mentioned company with the named places of manufacture and the listed products with the related type references. The place of manufacture shall be equipped in a way that a constant manufacturing of the certified construction is assured.*

*The approval is valid as long as the VDE specifications are in force, on which the certification is based on, unless it is withdrawn according to the VDE Testing and Certification Procedure (PM102E).*

*The validity period of a VDE-GS-Mark Approval may be prolonged on request. In case of changes in legal and / or normative requirements, the validity period of a VDE-GS-Mark Approval may be shortened.*

*Products containing the biocide dimethylfumarate (DMF) may not be marketed or made available on the EC market according to the Commission Decision 2009/251/EC.*

*The approval is solely signed on the first page.*

Certificate Number: 22009

# CERTIFICATE OF APPROVAL

ISSUED PURSUANT TO THE ELECTRICITY (CONSUMER SAFETY) ACT 2004

## ISSUED TO:

Yung Li Co Ltd

## CLASS OF ARTICLE:

Appliance Connector

## DESCRIPTION OF ARTICLE:

**Plug Connector**  
(Non-rewirable, thermoplastic moulded, Standard Sheet 'E' plug connector for class I equipment, integrally moulded to any <HAR> certified H05VV-F 3G 1.0mm<sup>2</sup>, or Australian approved three-core, 1.00mm<sup>2</sup>, PVC insulated and sheathed ordinary duty circular flexible cord)  
250V, ac, 10A

EXAMINED FOR COMPLIANCE WITH: AS/NZS 60320.2.2 : 2004

TYPE REFERENCE CODE: Type No. YP-32

## APPROVAL MARK:

Each electrical article of the abovementioned type shall be marked with Approval Number NSW22009 or N14885 ;or  
the Regulatory Compliance Mark (RCM) provided that the requirements of all relevant parts of AS/NZS 4417 applicable to the article are fulfilled.

DATE OF APPROVAL: 09 November 2006

This approval expires 09 November 2011 unless suspended, cancelled, renewed or extended.



for Commissioner for Fair Trading

Ref: 22009/1

## ADDENDUM TO CERTIFICATE OF APPROVAL 22009

## Particulars of Modification(s)

1. Original Model No. YP-32 alternatively moulded to any <HAR> certified H05VV-F 3G 0.75mm<sup>2</sup> or Australian approved three-core, 0.75mm<sup>2</sup>, PVC insulated and sheathed ordinary duty circular flexible cord not exceeding two metres in length.
2. Original Model No. No. YP-32 alternatively moulded to any <HAR> certified H05VV-F 3G1.5mm<sup>2</sup> or equivalent Australian approved three-core, 1.5mm<sup>2</sup>, PVC insulated and sheathed ordinary duty circular flexible cord .

Approved: 09 November 2006



for Commissioner for Fair Trading



Fair  
Trading

Ref: NSW22009/2

RENEWAL OF CERTIFICATE OF APPROVAL NSW22009

PARTICULARS OF RENEWAL

The approval of the original plug connector Model YP-32 and approved modifications has been renewed.

The Approval expires on 09/11/2016 unless it is renewed, extended, suspended or cancelled.

A handwritten signature in black ink, appearing to be 'D. Smith'.

For Commissioner for Fair Trading

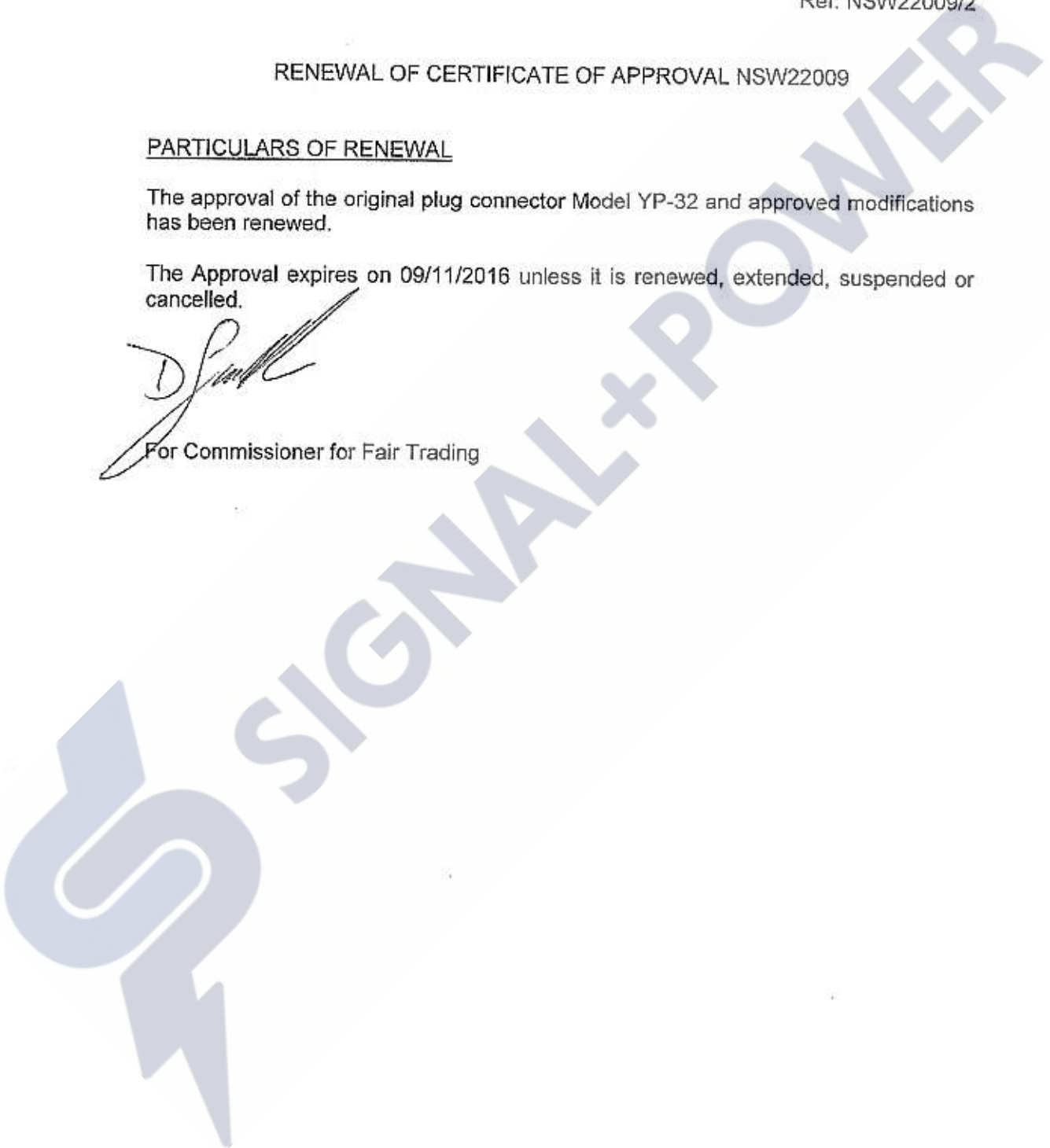



Fair  
Trading

Ref: NSW22009/4

## RENEWAL OF CERTIFICATE OF APPROVAL: NSW22009

### Particulars of Renewal

The approval of the original plug connector Model YP-32 and all approved modifications has been renewed for FIVE years.

The Approval expires on 09/11/2021 unless it is renewed, extended, suspended or cancelled.

For Commissioner for Fair Trading



Certificate Number: 22012

# CERTIFICATE OF APPROVAL

ISSUED PURSUANT TO THE ELECTRICITY (CONSUMER SAFETY) ACT 2004

**ISSUED TO:**

Yung Li Co Ltd

**CLASS OF ARTICLE:**

Appliance Connector

**DESCRIPTION OF ARTICLE:**

Appliance Connector  
(Non-rewirable, straight entry, Group 1, C13 appliance connector for cold conditions for Class I equipment integrally moulded to any <HAR> certified H05VV-F 3G1.00mm<sup>2</sup> or Australian approved three-core, 1.00mm<sup>2</sup>, PVC insulated and sheathed ordinary duty circular flexible cord)  
250V, ac, 10A

**EXAMINED FOR COMPLIANCE WITH:** AS/NZS 60320.1 : 2004

**TYPE REFERENCE CODE:** Type No. YC-12

**APPROVAL MARK:**

Each electrical article of the abovementioned type shall be marked with Approval Number NSW22012 or N14877 ;or  
the Regulatory Compliance Mark (RCM) provided that the requirements of all relevant parts of AS/NZS 4417 applicable to the article are fulfilled.

**DATE OF APPROVAL:** 31 October 2006

This approval expires 31 October 2011 unless suspended, cancelled, renewed or extended.



for Commissioner for Fair Trading

Ref: 22012/1

## ADDENDUM TO CERTIFICATE OF APPROVAL 22012

## Particulars of Modification(s)

1. Type No. YC-12 alternatively moulded to any <HAR> certified H05VV-F 3G0.75mm<sup>2</sup> or Australian approved, three-core, 0.75mm<sup>2</sup>, PVC insulated and sheathed ordinary duty circular flexible cord not exceeding two metres in length.
2. Type No. YP-32 being similar to original Type No. YC-12 except a Standard Sheet 'E' Interconnection Plug Connector (AS/NZS 60320.2.2) alternatively moulded to either:-
  - (a) Any <HAR> certified H05VV-F 3G1.00mm<sup>2</sup> or equivalent Australian approved flexible cord; or
  - (b) Any <HAR> certified H05VV-F 3G0.75mm<sup>2</sup> or equivalent Australian approved flexible cord not exceeding two metres in length.
3. Type No. YC-12 alternatively moulded to any <HAR> certified H05VV-F 3G1.5mm<sup>2</sup> or Australian approved three-core, 1.5mm<sup>2</sup>, PVC insulated and sheathed ordinary duty circular flexible cord.

Approved: 31 October 2006



for Commissioner for Fair Trading



Fair  
Trading

Ref: NSW22012/2

RENEWAL OF CERTIFICATE OF APPROVAL NSW22012

PARTICULARS OF RENEWAL

The approval of the original appliance connector Model YC-12 and approved modifications has been renewed.

The Approval expires on 31/10/2016 unless it is renewed, extended, suspended or cancelled.

A handwritten signature in black ink, appearing to be "D. J. ...".

For Commissioner for Fair Trading





Fair  
Trading

Ref: NSW22012/3

## RENEWAL OF CERTIFICATE OF APPROVAL: NSW22012

### Particulars of Renewal

The approval of the original appliance connector Model YC-12 and approved modifications has been renewed for FIVE years.

The Approval expires on 31/10/2021 unless it is renewed, extended, suspended or cancelled.

For Commissioner for Fair Trading

# 適合同等証明書

Statement of Conformity Assessment

電気用品安全法第8条第1項に規定する技術基準及び同法第9条第2項の経済産業省令で定める基準（法第9条第1項第2号に係る検査に係るものに限る）に適合していることを証明します

I hereby certify that the product mentioned below complies with the technical requirements stipulated in Paragraph 1 of Article 8 of Electrical Appliances and Materials Safety Act (here under referred to as the Act) and the requirements defined by the ordinance of the Ministry of Economy, Trade and Industry based on Paragraph 2 of Article 9 of the Act (limited to Item 2 of Paragraph 1 of Article 9 for Inspection of the Act).

1. 証明書番号: JET5087-43001-1012  
Statement Number
2. 交付年月日: 平成29年1月12日  
Effective Date January 12, 2017
3. 有効年月日: 平成36年1月11日  
Date of Validity January 11, 2024
4. 申込者名 (Applicant)  
住所: DAPU INDUSTRIAL ZONE, GANGZI, CHANGPING TOWN,  
DONGGUAN CITY, GUANGDONG PROVINCE, CHINA  
Address

氏名又は名称: YUNG LI CO., LTD.  
Name

5. 特定電気用品名: 差込みプラグ  
Name of Product Attachment plugs
6. 型式の区分: 別紙のとおり  
Type Classification See attached "Type Classification"
7. 製造工場名 (Manufacturer)  
住所: DAPU INDUSTRIAL ZONE, GANGZI, CHANGPING TOWN,  
DONGGUAN CITY, GUANGDONG PROVINCE, CHINA  
Address

氏名又は名称: YUNG LI CO., LTD.  
Name

8. 適用試験規格: 電気用品の技術上の基準を定める省令の解釈  
Applied Standard for Testing Description of the technical requirements by the METI Ordinance  
別表第四1、6及び別表第十 第5章

Appendix 4 Section 1, Section 6 and Appendix 10 Chapter 5

9. 適合性検査の方法: (Testing Method for Conformity Assessment)
  - 1) 試験用の特定電気用品については、電気用品の技術上の基準を定める省令の解釈に定める方法  
With respect to testing for Category A products, the testing method is based on the technical requirements of the description of Electrical Appliances and Materials stipulated in the METI Ordinance.
  - 2) 当該特定電気用品に係る届出事業者又は事業場における検査設備については、電気用品安全法施行規則別表第四の検査設備の欄に掲げる検査設備ごとにそれぞれ同表の技術上の基準の欄に掲げる方法  
With respect to inspection facilities required for Category A products at the factory, Testing Method described in the column of the technical requirements for each inspection facilities in the column of inspection facilities is shown in the Appendix 4 of Enforcement Regulations of the Act.

## 10. 注意事項

- 1) この適合同等証明書は、提出された試験用の電気用品に関して評価を行った上で交付したものであり、同一の型式の区分にある電気用品について電気用品安全法第8条1項に規定する技術基準適合確認の義務を履行したことを示すものではありません。

This Statement of Conformity Assessment, which is issued on the evaluation of the submitted test-use Electrical Appliances and Materials, does not signify that the Obligation to Comply with Requirements, which is prescribed at Paragraph 1 of Article 8 of the Act, is fulfilled on Electrical Appliances and Materials in the same Type Classification.

- 2) この適合同等証明書は、別紙に記載されている型式の区分の範囲内及び区分の組み合わせについてのみ有効です。

This Statement of Conformity Assessment is valid only for Electrical Appliances and Materials within the Type Classifications and their combination as stated in the attached "Type Classification".

一般財団法人 電気安全環境研究所  
Japan Electrical Safety & Environment technology Laboratories (JET)

理事長 薦田 康久  
President Yasuhisa Komoda

東京都渋谷区代々木5-14-12  
(5-14-12, Yoyogi, Shibuya-ku, Tokyo, Japan)

証明書番号 : J E T 5 0 8 7 - 4 3 0 0 1 - 1 0 1 2

# 適合同等証明書別紙

Statement of Conformity Assessment

## 型式の区分

Type Classification

要素 Factor	区分 Classification
定格電圧 Rated voltage	(2) 125Vを超えるもの Exceeding 125V
定格電流 Rated current	(3) 7Aを超え15A以下のもの Exceeding 7A, and less than or equal to 15A
極の配置（別表第二の一aに掲げる寸法に適合するもの場合に限る。） Pole configuration (limited to those specified in sub-clause 1a of Appendix 2)	—
極の数（別表第二の一bに掲げる寸法に適合するもの場合に限る。） Number of poles (limited to those specified in sub-clause 1b of Appendix 2)	(2) アース極を含めて3のもの Three including earth
刃の取付けの方式 Blade fixing method	(1) 一体として成形されているもの Integrated type
主絶縁体の材料 Insulation materials	(1) 合成樹脂のもの Plastic
外郭の材料 Outer case materials	(2) 合成樹脂のもの Plastic
接続の方式 Connection method	(1) 差し込み型のもの（ロックナット式のものを除く。） Plug-in type (excluding those with locking nuts)
防水構造 Type of waterproof	(3) 非防水型のもの Not treated with waterproof type

# 適合同等証明書

Statement of Conformity Assessment

電気用品安全法第8条第1項に規定する技術基準及び同法第9条第2項の経済産業省令で定める基準（法第9条第1項第2号に係る検査に係るものに限る）に適合していることを証明します

I hereby certify that the product mentioned below complies with the technical requirements stipulated in Paragraph 1 of Article 8 of Electrical Appliances and Materials Safety Act (here under referred to as the Act) and the requirements defined by the ordinance of the Ministry of Economy, Trade and Industry based on Paragraph 2 of Article 9 of the Act (limited to Item 2 of Paragraph 1 of Article 9 for Inspection of the Act).

1. 証明書番号: JET5087-43004-1004  
Statement Number
2. 交付年月日: 平成29年1月12日  
Effective Date January 12, 2017
3. 有効年月日: 平成36年1月11日  
Date of Validity January 11, 2024
4. 申込者名 (Applicant)  
住所: DAPU INDUSTRIAL ZONE, GANGZI, CHANGPING TOWN,  
DONGGUAN CITY, GUANGDONG PROVINCE, CHINA

氏名又は名称: YUNG LI CO., LTD.  
Name

5. 特定電気用品名: コードコネクターボディ  
Name of Product Cord connector bodies
6. 型式の区分: 別紙のとおり  
Type Classification See attached "Type Classification"
7. 製造工場名 (Manufacturer)  
住所: DAPU INDUSTRIAL ZONE, GANGZI, CHANGPING TOWN,  
DONGGUAN CITY, GUANGDONG PROVINCE, CHINA

氏名又は名称: YUNG LI CO., LTD.  
Name

8. 適用試験規格: 電気用品の技術上の基準を定める省令の解釈  
Applied Standard for Testing Description of the technical requirements by the METI Ordinance  
別表第四1、6及び別表第十 第5章  
Appendix 4 Section 1, Section 6 and Appendix 10 Chapter 5

9. 適合性検査の方法: (Testing Method for Conformity Assessment)

- 1) 試験用の特定電気用品については、電気用品の技術上の基準を定める省令の解釈に定める方法

With respect to testing for Category A products, the testing method is based on the technical requirements of the description of Electrical Appliances and Materials stipulated in the METI Ordinance.

- 2) 当該特定電気用品に係る届出事業者又は事業場における検査設備については、電気用品安全法施行規則別表第四の検査設備の欄に掲げる検査設備ごとにそれぞれ同表の技術上の基準の欄に掲げる方法

With respect to inspection facilities required for Category A products at the factory, Testing Method described in the column of the technical requirements for each inspection facilities in the column of inspection facilities is shown in the Appendix 4 of Enforcement Regulations of the Act.



## 10. 注意事項

- 1) この適合同等証明書は、提出された試験用の電気用品に関して評価を行った上で交付したものであり、同一の型式の区分にある電気用品について電気用品安全法第8条1項に規定する技術基準適合確認の義務を履行したことを示すものではありません。

This Statement of Conformity Assessment, which is issued on the evaluation of the submitted test-use Electrical Appliances and Materials, does not signify that the Obligation to Comply with Requirements, which is prescribed at Paragraph 1 of Article 8 of the Act, is fulfilled on Electrical Appliances and Materials in the same Type Classification.

- 2) この適合同等証明書は、別紙に記載されている型式の区分の範囲内及び区分の組み合わせについてのみ有効です。

This Statement of Conformity Assessment is valid only for Electrical Appliances and Materials within the Type Classifications and their combination as stated in the attached "Type Classification".

一般財団法人 電気安全環境研究所  
Japan Electrical Safety & Environment Technology Laboratories (JET)

理事長 薦田 康久  
President Yasuhisa Komoda

東京都渋谷区代々木5-14-12  
(5-14-12, Yoyogi, Shibuya-ku, Tokyo, Japan)

証明書番号：JET5087-43004-1004

# 適合同等証明書別紙

Statement of Conformity Assessment

## 型式の区分

Type Classification

要素 Factor	区分 Classification
定格電圧 Rated voltage	(2) 125Vを超えるもの Exceeding 125V
定格電流 Rated current	(3) 7Aを超え10A以下のもの Exceeding 7A, and less than or equal to 10A
極の配置（別表第二の一aに掲げる寸法に適合するもの場合に限る。） Pole configuration (limited to those specified in sub-clause 1a of Appendix 2)	—
極の数（別表第二の一bに掲げる寸法に適合するもの場合に限る。） Number of poles (limited to those specified in sub-clause 1b of Appendix 2)	(2) アース極を含めて3のもの Three including earth
接続の方式 Connection method	(1) 差し込み型のもの（ロックナット式のものを除く。） Plug-in type (excluding those with locking nuts)
接続する電線の種類（一般固定配線用のもの場合に限る。） Type of cable or cord to be connected (limited to socket outlets)	—
主絶縁体の材料 Insulation materials	(1) 合成樹脂のもの Plastic
外郭の材料 Outer case materials	(2) 合成樹脂のもの Plastic
スイッチ Switch	(2) ないもの Without switch
種類（一般固定配線用のもの場合に限る。） Type (limited to socket outlets)	—
使用の方法（コンセントの場合に限る。） Method of use (limited to socket outlets)	—
電源との接続の方式（マルチタップの場合に限る。） Power supply terminals (limited to multiple socket-outlet (with cord or pins for power supply connections))	—
電線と器体との一体成形（コンセントの場合を除く。） Non-rewirable construction (except socket outlets)	(1) あるもの With non-rewirable construction
防水構造 Type of waterproof	(3) 非防水型のもの Not treated with waterproof type

証明書番号：JET5087-43004-1004

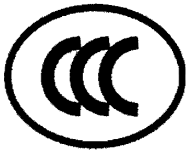

# CERTIFICATE FOR CHINA COMPULSORY PRODUCT CERTIFICATION

CERTIFICATE NO.: 2009010101357110

## NAME AND ADDRESS OF THE APPLICANT

Yung Li Co.,Ltd.

Dapu Industrial Zone, Gangzi, Changping Town, Dongguan

## NAME AND ADDRESS OF THE MANUFACTURER

Yung Li Co.,Ltd.

Dapu Industrial Zone, Gangzi, Changping Town, Dongguan

## NAME AND ADDRESS OF THE FACTORY

Yung Li Co.,Ltd.

Dapu Industrial Zone, Gangzi, Changping Town, Dongguan

## PRODUCT NAME, MODEL AND SPECIFICATION

### INTERCONNECTION CORD SET

YP-32 + YC-12 10A 250V~(配 60227IEC53 3×1.5mm<sup>2</sup>,60227IEC53 3×1mm<sup>2</sup>,60227IEC53 3×0.75mm<sup>2</sup>),YP-32 + YC-12L 10A 250V~(配 60227IEC53 3×1.5mm<sup>2</sup>,60227IEC53 3×1mm<sup>2</sup>,60227IEC53 3×0.75mm<sup>2</sup>),YP-32 L + YC-12L 10A 250V ~ ( 配 60227IEC53 3×0.75 mm<sup>2</sup>、 60227IEC53 3×1 mm<sup>2</sup>、 60227IEC53 3×1.5 mm<sup>2</sup> ) ,YP-32L + YC-12 10A 250V ~ ( 配 60227IEC53 3×0.75mm<sup>2</sup>、 60227IEC53 3×1mm<sup>2</sup>、 60227IEC53 3×1.5mm<sup>2</sup> )

## THE STANDARDS AND TECHNICAL REQUIREMENTS FOR THE PRODUCTS

GB/T15934-2008

This is to certify that the above mentioned product(s) complies with the requirements of implementation rules for compulsory certification(REFNO.CNCA-C02-01:2014).

Valid from: Apr.13,2018

Valid until: Apr.13,2023

The validity of the certificate is subject to positive result of the regular follow up inspection by issuing certification body until the expiry date.

Date of original issued: Aug.14,2009

The certificate information is available through CNCA's website: [www.cnca.gov.cn](http://www.cnca.gov.cn)



President:

Wang Kejiao



## CHINA QUALITY CERTIFICATION CENTRE

접수번호 : 18-014285-01-1  
(Receipt No.)



# 안전인증서

## Safety Certificate

안전인증번호 : SU04001-1004C  
(Certificate No.)

제조업자/수입업자명 : Yung Li Co., Ltd.  
(Manufacturer/importer)

주소 : Da Pu Industrial Zone, Chang Ping Town, Dong Guan City,  
(Address) Guang Dong 523571, China

제품명 : 상호연결커플러 (Plug connector)  
(Product)

기본모델명 : YP-32  
(Basic Model)

파생모델명 : Not Applicable  
(Series Model)

정격/안전기준상의 모델구분 : 10 A, 250 V~  
(Rating)

시험기준 : KC60320-1(2015-09), K60320-2-2 (2006-12)  
(Standard)

본 인증서는 제조국명 : 중국  
제조업자명 : Yung Li Co., Ltd.  
제조공장의 주소 : Da Pu Industrial Zone, Chang Ping Town, Dong Guan City,  
Guang Dong 523571, China  
의 제품에만 해당함

「전기용품 및 생활용품 안전관리법 시행규칙」 제9조제2항·제4항 또는 제10조제2항에 따라 안전인증서를 발급합니다.

We Issue This Safety Certificate for the above appliances in accordance with the Article 9(2),9(4) or10 (2) of the Enforcement Rule of the Electrical Appliances and Consumer Products Safety Control Act.

2018 년 04 월 06 일  
Year month day

### 한국산업기술시험원장

### KOREA TESTING LABORATORY



\* 이 인증서는 「전기용품 및 생활용품 안전관리법 시행규칙」에 따른 제품의 안전성 확인에 한정된 것이며, 그 밖의 다른 법률이 적용되는 제품의 경우에는 해당 법률에 따라 추가로 인증·허가 등을 받아야 합니다.

첨부서류

1. 전기용품의 안전관리부품 및 재질목록(List of Critical Components)
2. 기본모델·파생모델의 내용 (Descriptions of the basic and series model)
3. 안전인증의 변경 현황 (Revisions Status)

**첨부 1 : 전기용품의 안전관리부품 및 재질목록**  
List of Critical Components

부품명(회로기호) Component(Part no.)	제조사(상표명) Manufacturer(Brand)	모델명(형식) Model(Type)	정격 또는 특성 Rating or Characteristics	인증마크 Tested by
Power Cord	Yung Li	60227 IEC 53 (H05VV-F)	3 X 0.75 mm <sup>2</sup>	KC
Alt. Power Cord	Yung Li	60227 IEC 53 (H05VV-F)	3 X 1.0 mm <sup>2</sup>	KC
Alt. Power Cord	Yung Li	60227 IEC 53 (H05VV-F)	3 X 1.5 mm <sup>2</sup>	KC

**유의사항 (Attention) :**

- 안전관리부품은 전기적인 안전에 직접적인 영향을 주는 부품으로서 안전인증기관이 정기공장검사 시 확인 관리 하는 사항입니다. 따라서 상기목록에 기재된 사항을 변경하거나 또는 복수등재를 원하시는 경우는 안전인증기관에 인증변경신청을 하여야 합니다.

*As the "Critical components" are parts in directly related with safety, these components shall be checked during a factory inspection by the certification body. In case of applying multiple listing or changing the items above, the certification revision shall be applied.*

- 인증변경신청 없이 임의로 변경하는 경우는, 전기용품 및 생활용품 안전관리법 시행규칙 제 20 조제 1 항 또는 제 36 조제 1 항 규정에 의한 안전인증 취소 혹은 안전확인신고 효력상실 사유가 됨을 유의하시기 바랍니다.

*The Safety Certification will be cancelled under the Article 20(1), 36(1) of the Enforcement Rule of the Electrical appliances and Consumer Products Safety Control Act if the contents of the Certification is altered without our authorization.*

FP511-04

□ 첨부 2 : 기본모델 · 파생모델의 내용

Description of the basic and series model

파생모델명 Derivative model	기본모델과의 차이점 Differences between the basic and derivative model(s)
Not Applicable	
제품특기사항 및 시험조건 Remarks & Test conditions	
<p>1. Test Report Ref. No. : 01-920-2506 (2001. 11. 2)</p> <p>2. Product Description</p> <ul style="list-style-type: none"> <li>- Ratings : 10 A, 250 V~</li> <li>- Method of connecting the cable : Non-rewirable accessories</li> <li>- provision for earthing: 2 pole with earthing contact</li> <li>- The plug connector (basic model YP-32) is combined with power cord.</li> </ul>	
<p>□ 본 제품의 시험내용에 관하여 의문사항이 있으시면 아래 연락처로 문의하시기 바랍니다. 시험 담당자 : 인증산업본부 전기용품평가센터 홍 기정 / 055-791-3432</p> <p>□ <i>If you have any question on product testing, please contact the person below:</i> <i>Job holder: Certification Business Division, Electrical Components Testing Center, K. J. Hong / +82 55-791-3432</i></p>	

FP511-05

**첨부 3 : 안전인증의 변경 현황**  
Revisions Status

변경발급 내용 Contents of Certificate Revisions
1 <sup>st</sup> Rev.) Critical component is added. And rating is changed. (05-1920-0342 : 2005.04.01) - Adding power cord : H05VV-F 3G 0.75 mm <sup>2</sup> , 1.0 mm <sup>2</sup> , 1.5 mm <sup>2</sup> - Changing rated current : 7A → 10A
2 <sup>nd</sup> Rev.) Change of company address (11-1920-6944 : 2011.12.07.) - Before : Da Pu Industrial Zone, Chang Ping Town, Dong Guan City, Guang Dong 511736, P.R.China After : Da Pu Industrial Zone, Chang Ping Town, Dong Guan City, Guang Dong 523571, P.R.China
3 <sup>th</sup> Rev.) Standard update (18-014285-01-2 : 2018.04.05.) - Standard is updated (K 60320-2-2)

FP511-06

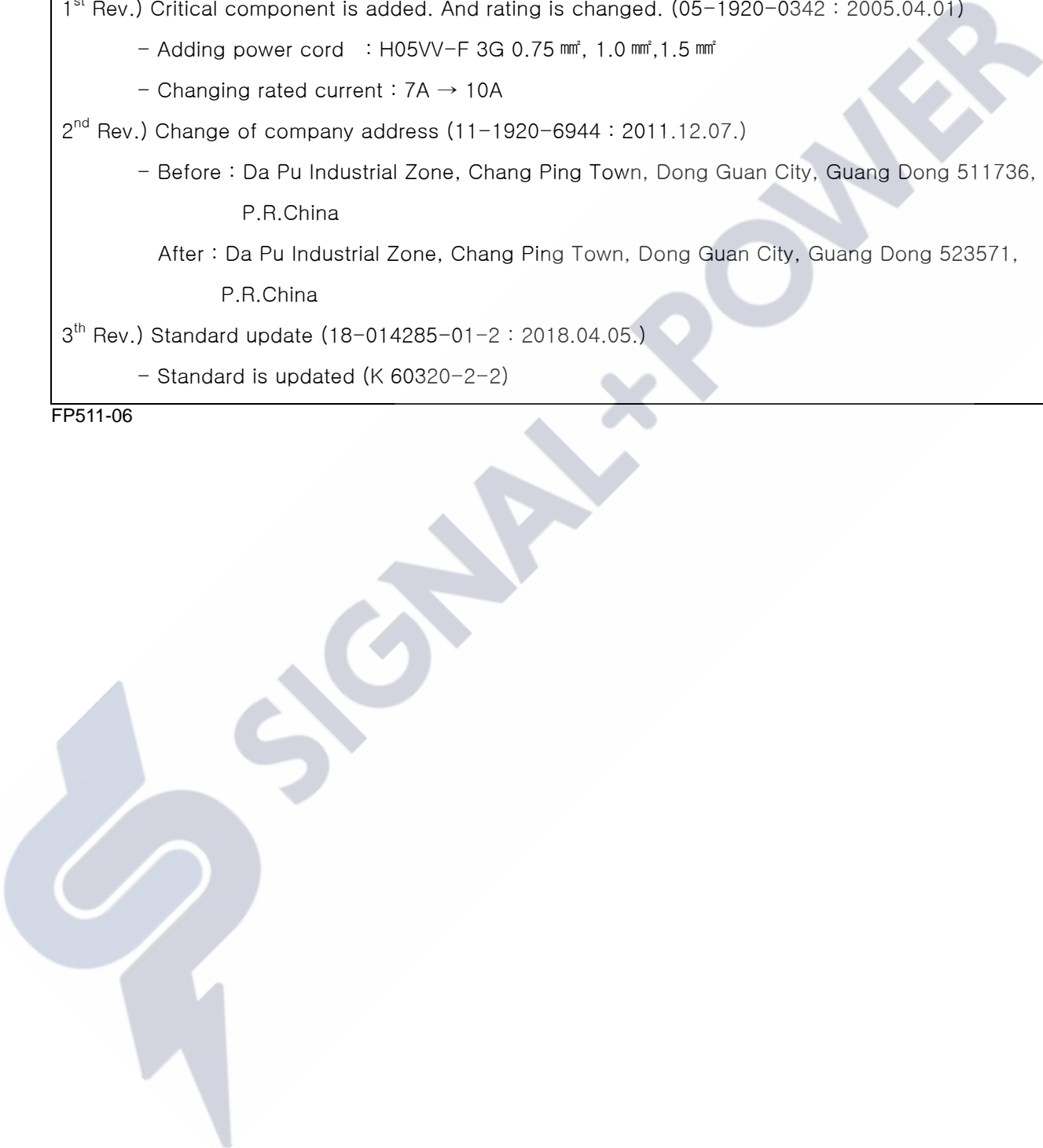



# 전기용품안전인증서

## Electrical Appliances Safety Certificate

안전인증번호 : SU04001-1002A  
(Certificate No.)

접수번호 : 05-1920-0337  
(Order No.)

제조사명 : Yung Li Co., Ltd. China  
(Manufacturer)

공장소재지 : Da Pu Industrial Zone, Chang Ping Town, Dong Guan City,  
(Factory Address) Guang Dong 511736, China

제품명 : 상호연결커플러 (Appliances Coupler)  
(Product)

기본모델명 : YC-12  
(Basic Model)

정격 : AC250V, 10A  
(Electrical Ratings)

파생모델명 : Not Applicable  
(Series Model)

적용기준 : K60320-1  
(Applied Standard)

- 첨부 : 1. 기본모델·파생모델의 내용 (General Descriptions of Certified Products)  
2. 전기용품안전인증서의 변경발급 현황 (Status of Compliance Certificate Revisions)  
3. 안전관리 부품목록 (List of Critical Components)

전기용품 안전관리법 제5조의 규정에 의하여 위의 전기용품에 대하여 안전인증서를 교부합니다.

We Certificate Electrical Appliances Safety Certification as above product by Article 5 of the Electrical Appliance Safety Control Law.

2005년 04월 06일  
year month day



안전인증기관  
산업기술시험원  
KOREA TESTING LABORATORY

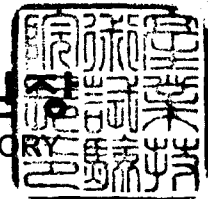



**첨부 1 : 기본모델·파생모델의 내용**  
General description of Certified Products

파생모델명 Derivative model	기본모델과의 차이점 Differences between the basic and derivative model(s)
Not Applicable	
제품특기사항 및 시험조건 Remarks & Test conditions	
<p>1. Test Report No. : 01-920-2504 (2001. 11. 2)</p> <p>2. Product Description</p> <ul style="list-style-type: none"> <li>- This Appliance coupler "YC-12 (10A 250V~)" is combined with VCTF 3C X 0.75 mm<sup>2</sup> power cord.</li> <li>- Head figure of appliance coupler is illustrated in the "Standard sheet C13 of IEC60320-1".</li> <li>- Appliance coupler is moulded with power cord straightly &amp; has earthing contact line.</li> </ul>	
<p><input type="checkbox"/> 본 제품의 시험내용에 관하여 문의하실 사항이 있으시면 아래 연락처로 문의하시기 바랍니다. 시험담당자 : 전기전자본부 신뢰성평가팀, 강호우 / (02)8601-415</p> <p><input type="checkbox"/> <i>If you have any question on product testing, please contact the person below :</i> Job holder : Electrotechnical Center Reliability Assessment Team, H.W.KANG/+82 2 8601-415</p>	

FP511-09-00

**첨부 2 : 전기용품안전인증서의 변경발급현황**  
Status of Compliance Certificate Revisions

변경발급 내용 Contents of Certificate Revisions	비고 Remarks
<p>1st. Rev) Critical component is added. And rating is changed. (05-1920-0337 : 2005.04.01)</p> <ul style="list-style-type: none"> <li>- Adding power cord : H03VV-F 3G 0.75 mm<sup>2</sup> , H05VV-F 3G 0.75 mm<sup>2</sup>, 1.0 mm<sup>2</sup>, 1.5 mm<sup>2</sup></li> <li>- Changing rated current : 7A → 10A</li> </ul>	

FP511-11-00

첨부 3 : 안전관리부품 목록  
List of Critical Components

부품명 (회로기호) Component(Part no.)	제조사(상표명) Manufacturer(Brand)	모델명(형식) Model(Type)	정격 또는 특성 Rating or Characteristics	인증마크 Tested by
Power cord	Yung Li	60227 IEC 52 (H03VV-F)	3G 0.75 mm <sup>2</sup>	EK
		60227 IEC 53 (H05VV-F)	3G 0.75 mm <sup>2</sup>	
			3G 1.0 mm <sup>2</sup>	
			3G 1.5 mm <sup>2</sup>	

유의사항 (Attention) :

1. 안전관리부품은 전기적인 안전에 직접적인 영향을 주는 부품으로서 안전인증기관이 정기공장검사시 확인 관리 하는 사항입니다. 따라서 상기목록에 기재된 사항을 변경하거나 또는 복수등재를 원하시는 경우는 안전인증기관에 인증변경신청을 하여야 합니다.

*As the "Critical components" are parts in directly related with safety, these components shall be checked during a factory inspection by the certification body. In case of applying multiple listing or changing the items above, the certification revision shall be applied.*

2. 인증변경신청 없이 임의로 변경하는 경우는, 전기용품안전관리법 제 9 조제 1 항의 규정에 의한 안전인증 취소 사유가 됨을 유의하시기 바랍니다.

*The Safety Certification will be cancelled under the Safety Control Law for Electrical Appliances, Paragraph 1 of Article 9 if the contents of the Certification is altered without our authorization*



Vkan Certification & Testing Co., Ltd.

## Verification of Compliance

No. UKCA21-0015

**Applicant:**

**Yung-Li Co. Ltd.**

Da Pu Industrial Zone, Gang Zi Chang Ping Town, 523571,  
Dongguan City, Guangdong, CHINA

**Product/Material:**

**Plug Connector for 10A/250V for use in class I equipment,  
in cold conditions**

**Trade Mark:**

—

**Model/Type:**

YP-32, YP-32L, YP-32L-1, YP-32L-2, YP-32L-3

**Rated Specification:**

See Appendix

**Regulation(s)  
Complied with:**

The Electrical Equipment (Safety) Regulations 2016

**Tested According to:**

BS EN 60320-1:2015, BS EN 60320-3:2014

**Referred to the  
Technical Report:**

UKCA2021-0013

*This verification of compliance is based on an evaluation of a tested sample of the product mentioned above. It does not imply assessment of series-production of the product. The applicant should hold the whole technical report at the disposal of the competent authority.*

*Provided it is also in conformity with any other UK regulations, the manufacturer or its authorized representative should draw up a UK Declaration of Conformity and affix the UKCA mark shown below to each conforming product.*



中国认可  
国际互认  
检测  
TESTING  
CNAS L0096



Signed by

Xie Haojiang

Date of Issue: May 8, 2021

Vkan Certification & Testing Co., Ltd.

No. 3, Tiantaiyi Road, Kaitai Avenue, Science City, Guangzhou, 510663, P. R. China

Tel.: +86-20-32293888, Fax: +86-20-32293889 E-mail: [office@cvc.org.cn](mailto:office@cvc.org.cn)

[www.cvc.org.cn](http://www.cvc.org.cn)



LTC-C-0041-UKCA-G0



Vkan Certification & Testing Co., Ltd.

## Verification of Compliance

APPENDIX to C.O.C No. UKCA21-0015

*Rated Specification:*

10A/250V~ YP-32 (H05VV-F 3G0, 75/3G1, 0/3G1, 5,  
H05V2V2-F, 3G0, 75/3G1, 0/3G1, 5, H05RR-F 3G0,  
75/3G1, 0, H05RN-F, 3G0,75) ,  
YP-32L (H05VV-F 3G0,75/3G1, 0/3G1, 5,  
H05V2V2-F,3G0, 75/3G1,0/3G1, 5),  
YP-32L-1 (H05VV-F 3G0, 75/3G1, 0/3G1, 5),  
YP-32L-2 (H05VV-F 3G0, 75/3G1, 0/3G1, 5),  
YP-32L-3 (H05VV-F 3G0, 75/3G1, 0/3G1, 5)



中国认可  
国际互认  
检测  
TESTING  
CNAS L0096

UK  
CA

Signed by

Xie Haojiang

Date of Issue: May 8, 2021

Vkan Certification & Testing Co., Ltd.

No. 3, Tiantaiyi Road, Kaitai Avenue, Science City, Guangzhou, 510663, P. R. China

Tel.: +86-20-32293888, Fax: +86-20-32293889 E-mail: [office@cvc.org.cn](mailto:office@cvc.org.cn)

[www.cvc.org.cn](http://www.cvc.org.cn)



LTC-C-0041-UKCA-G0



## Verification of Compliance

No. UKCA21-0004

**Applicant:**

**Yung-Li Co. Ltd.**

Da Pu Industrial Zone, Gang Zi Chang Ping Town,  
523571, Dongguan City, Guangdong, CHINA

**Product/Material:**

**Connector for 10A/250V for use in class I equipment  
in cold conditions**

**Trade Mark:**

—

**Model/Type:**

YC-12, YC-12L

**Rated Specification:**

See Appendix

**Regulation(s)  
Complied with:**

Appliance couplers for household and similar general  
purposes – Part 1:General requirements

**Tested According to:**

BS EN 60320-1:2015

**Referred to the  
Technical Report:**

UKCA2021-0005(XG1)

*This verification of compliance is based on an evaluation of a tested sample of the product mentioned above. It does not imply assessment of series-production of the product. The applicant should hold the whole technical report at the disposal of the competent authority. Provided it is also in conformity with any other UK regulations, the manufacturer or its authorized representative should draw up a UK Declaration of Conformity and affix the UKCA mark shown below to each conforming product.*



中国认可  
国际互认  
检测  
TESTING  
CNAS L0006



Signed by:

*Xie Haojiang*

Xie Haojiang

Date of Issue: Mar. 3<sup>rd</sup>, 2021



Vkan Certification & Testing Co., Ltd.

## Verification of Compliance

APPENDIX to C.O.C No. UKCA21-0004

*Rated Specification:*

YC-12 10A 250V~ (provided with H05VV-F 3G0,75/1/1,5mm<sup>2</sup>,  
H05V2V2-F 3G0,75/1/1,5mm<sup>2</sup>, H05RR-F 3G0,75/1/1,5mm<sup>2</sup>,  
H05RN-F 3G0,75/1mm<sup>2</sup>),  
YC-12L 10A 250V~ (provided with H05VV-F 3G0,75/1/1,5mm<sup>2</sup>,  
H05V2V2-F 3G0,75/1/1,5mm<sup>2</sup>; H05RR-F 3G0,75/1/1,5mm<sup>2</sup>,  
H05RN-F 3G0,75/1mm<sup>2</sup>)



中国认可  
国际互认  
检测  
TESTING  
CNAS L0096

UK  
CA

Signed by

Xie Haojiang

Date of Issue: Mar. 3<sup>rd</sup>, 2021

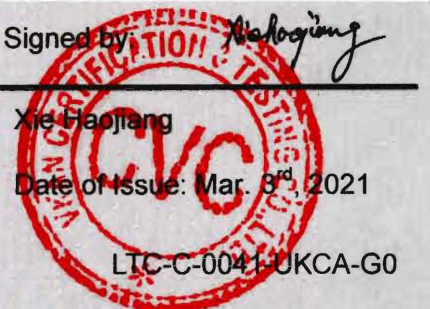

Vkan Certification & Testing Co., Ltd.

No. 3, Tiantaiyi Road, Kaitai Avenue, Science City, Guangzhou, 510663, P. R. China

Tel.: +86-20-32293888, Fax: +86-20-32293889 E-mail: [office@cvc.org.cn](mailto:office@cvc.org.cn)

[www.cvc.org.cn](http://www.cvc.org.cn)

LTC-C-0041-UKCA-G0

**ZJCZ.E241374**  
**Flexible Cord**[Page Bottom](#)**Flexible Cord**[See General Information for Flexible Cord](#)**YUNG LI CO LTD**

E241374

7F-12 NO 99 SEC 1 XINTAI 5TH RD  
XIZHI DISTRICT  
NEW TAIPEI, 22175 TAIWAN

**Decorative cord**, Type(s) SPT-1W, SPT-2W**Dryer and range cord**, Type(s) SRDT**Jacketed cord**, Type(s) S, SE, SE-HF, SJ, SJE, SJE-HF, SJO, SJO, SJOOW, SJOW, SJJ, SJJ-B, SJTO, SJTOW, SJTW, SO, SOO, SOOW, SOW, ST, ST-B, STO, STOW, STW, SVE, SVE-HF, SVT, SVT-B, SVTO**Parallel cord**, Type(s) NISPE-1, NISPE-1-HF, NISPE-2, NISPE-2-HF, NISPT-1, NISPT-2, SPE-1, SPE-1-HF, SPE-2, SPE-2-HF, SPE-3, SPE-3-HF, SPT-1, SPT-2, SPT-3[Last Updated](#) on 2016-03-07[Questions?](#)[Print this page](#)[Terms of Use](#)[Page Top](#)

◆ 2016 UL LLC

The appearance of a company's name or product in this database does not in itself assure that products so identified have been manufactured under UL's Follow-Up Service. Only those products bearing the UL Mark should be considered to be Certified and covered under UL's Follow-Up Service. Always look for the Mark on the product.

UL permits the reproduction of the material contained in the Online Certification Directory subject to the following conditions: 1. The Guide Information, Assemblies, Constructions, Designs, Systems, and/or Certifications (files) must be presented in their entirety and in a non-misleading manner, without any manipulation of the data (or drawings). 2. The statement "Reprinted from the Online Certifications Directory with permission from UL" must appear adjacent to the extracted material. In addition, the reprinted material must include a copyright notice in the following format: "© 2016 UL LLC".

# 適合同等証明書

Statement of Conformity Assessment

電気用品安全法第8条第1項に規定する技術基準及び同法第9条第2項の経済産業省令で定める基準（法第9条第1項第2号に係る検査に係るものに限る）に適合していることを証明します

I hereby certify that the product mentioned below complies with the technical requirements stipulated in Paragraph 1 of Article 8 of Electrical Appliances and Materials Safety Act (here under referred to as the Act) and the requirements defined by the ordinance of the Ministry of Economy, Trade and Industry based on Paragraph 2 of Article 9 of the Act (limited to Item 2 of Paragraph 1 of Article 9 for Inspection of the Act).

1. 証明書番号: JET5087-12009-1002  
Statement Number
2. 交付年月日: 2019年3月24日  
Effective Date March 24, 2019
3. 有効年月日: 2026年3月23日  
Date of Validity March 23, 2026
4. 申込者名 (Applicant)  
住 所: DAPU INDUSTRIAL ZONE, GANGZI, CHANGPING TOWN,  
Address DONGGUAN CITY, GUANGDONG PROVINCE, CHINA

氏名又は名称: YUNG LI CO., LTD.  
Name

5. 特定電気用品名: キャブタイヤコード  
Name of Product Sheathed flexible cords
6. 型式の区分: 別紙のとおり  
Type Classification See attached "Type Classification"
7. 製造工場名 (Manufacturer)  
住 所: DAPU INDUSTRIAL ZONE, GANGZI, CHANGPING TOWN,  
Address DONGGUAN CITY, GUANGDONG PROVINCE, CHINA

氏名又は名称: YUNG LI CO., LTD.  
Name

8. 適用試験規格: 電気用品の技術上の基準を定める省令の解釈  
Applied Standard for Testing Description of the technical requirements by the METI Ordinance  
別表第一 1 (1), (6) 及び (9)  
Appendix 1 Section 1, (1), (6) and (9)

9. 適合性検査の方法: (Testing Method for Conformity Assessment)

- 1) 試験用の特定電気用品については、電気用品の技術上の基準を定める省令の解釈に定める方法

With respect to testing for Category A products, the testing method is based on the technical requirements of the description of Electrical Appliances and Materials stipulated in the METI Ordinance.

- 2) 当該特定電気用品に係る届出事業者又は事業場における検査設備については、電気用品安全法施行規則別表第四の検査設備の欄に掲げる検査設備ごとにそれぞれ同表の技術上の基準の欄に掲げる方法

With respect to inspection facilities required for Category A products at the factory, Testing Method described in the column of the technical requirements for each inspection facilities in the column of inspection facilities is shown in the Appendix 4 of Enforcement Regulations of the Act.



## 10. 注意事項

- 1) この適合同等証明書は、提出された試験用の電気用品に関して評価を行った上で交付したものであり、同一の型式の区分にある電気用品について電気用品安全法第8条1項に規定する技術基準適合確認の義務を履行したことを示すものではありません。

This Statement of Conformity Assessment, which is issued on the evaluation of the submitted test-use Electrical Appliances and Materials, does not signify that the Obligation to Comply with Requirements, which is prescribed at Paragraph 1 of Article 8 of the Act, is fulfilled on Electrical Appliances and Materials in the same Type Classification.

- 2) この適合同等証明書は、別紙に記載されている型式の区分の範囲内及び区分の組み合わせについてのみ有効です。

This Statement of Conformity Assessment is valid only for Electrical Appliances and Materials within the Type Classifications and their combination as stated in the attached "Type Classification".

一般財団法人 電気安全環境研究所  
Japan Electrical Safety & Environment Technology Laboratories (JET)

理事長 薦田 康久  
President Yasuhisa Komoda

東京都渋谷区代々木5-14-12  
(5-14-12, Yoyogi, Shibuya-ku, Tokyo, Japan)

証明書番号：JET5087-12009-1002

# 適合同等証明書別紙

Statement of Conformity Assessment

## 型式の区分

Type Classification

要素 Factor	区分 Classification
絶縁体の主材料 Insulation materials	(2) 耐熱性ビニル混合物のもの Heat resistant polyvinyl chloride
外装の主材料 Sheath materials	(2) 耐熱性ビニル混合物のもの Heat resistant polyvinyl chloride
導体の種類 Conductor type	(1) A種のもの Type A
線心の構造 Core structure	(1) 同一のもの Same
耐震性 Vibration resistance	(2) ないもの Not vibration resistant
金属製の導体補強線 Metal messenger wires	(2) ないもの Without metal messenger wires

証明書番号 : J E T 5 0 8 7 - 1 2 0 0 9 - 1 0 0 2

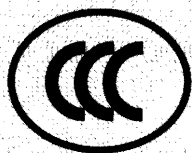

# CERTIFICATE FOR CHINA COMPULSORY PRODUCT CERTIFICATION

**CERTIFICATE NO.: 2004010105138414**

## **NAME AND ADDRESS OF THE APPLICANT**

Yung Li Co.,Ltd.  
Dapu Industrial Zone,Gangzi,Changping Town,Dongguan

## **NAME AND ADDRESS OF THE MANUFACTURER**

Yung Li Co.,Ltd.  
Dapu Industrial Zone,Gangzi,Changping Town,Dongguan

## **NAME AND ADDRESS OF THE FACTORY**

Yung Li Co.,Ltd.  
Dapu Industrial Zone,Gangzi,Changping Town,Dongguan

## **PRODUCT NAME, MODEL AND SPECIFICATION**

PVC insulated flexible cables and wires  
60227 IEC 52(RVV) 300/300V 0.5-0.75(2-3 芯); 60227 IEC 53(RVV) 300/500V 0.75-2.5(2-5 芯);

## **THE STANDARDS AND TECHNICAL REQUIREMENTS FOR THE PRODUCTS**

GB/T 5023.5-2008/IEC60227-5:2003

This is to certify that the above mentioned product(s) complies with the requirements of implementation rules for compulsory certification(REFNO.CNCA-C01-01:2014).

Valid from: Nov.20,2020

Valid until: Nov.20,2025

The validity of the certificate is subject to positive result of the regular follow up inspection by issuing certification body until the expiry date.

Date of original issued: Jan.04,2005

The certificate information is available through CNCA's website: [www.cnca.gov.cn](http://www.cnca.gov.cn)  
Accredited by China National Accreditation Service for Conformity Assessment (CNAS)



President:

Lu Mei



**CHINA QUALITY CERTIFICATION CENTRE**

## ZEICHENGENEHMIGUNG MARKS APPROVAL

Yung-Li Co. Ltd.  
Da Pu Industrial Zone, Cang Zi  
Chang Ping Town  
523571 DONG GUAN CITY  
Guangdong  
CHINA

ist berechtigt, für ihr Produkt /  
*is authorized to use for their product*

**Starkstromleitungen für allgemeine Anwendungen**  
**- Flexible Leitungen**  
**mit thermoplastischer PVC-Isolierung**  
***Cables for general applications***  
**- *Flexible cables with***  
***thermoplastic PVC insulation***

die hier abgebildeten markenrechtlich geschützten Zeichen  
für die ab Blatt 2 aufgeführten Typen zu benutzen /  
*the legally protected Marks as shown below for the types referred to on page 2 ff.*

◁VDE▷ oder/or ◁▷Ω▷ oder/or   
schwarz rot  
black red

Geprüft und zertifiziert nach /  
*Tested and certified according to*

DIN EN 50525-2-11 (VDE 0285-525-2-11):2012-01; EN 50525-2-11:2011

VDE Prüf- und Zertifizierungsinstitut GmbH  
*VDE Testing and Certification Institute*  
Zertifizierungsstelle / *Certification*

  
K. Prohaska

VDE Zertifikate sind nur gültig bei Veröffentlichung unter:  
*VDE certificates are valid only when published on:*

Aktenzeichen: 1609800-5140-0005 / 171941  
*File ref.:*

Ausweis-Nr. 40010145 Blatt 1  
*Certificate No. Page*

Weitere Bedingungen siehe Rückseite und Folgeblätter /  
*further conditions see overleaf and following pages*

Offenbach, 2004-04-27  
(letzte Änderung/updated 2012-09-25 )

<http://www.vde.com/zertifikat>  
<http://www.vde.com/certificate>

Name und Sitz des Genehmigungs-Inhabers / *Name and registered seat of the Certificate holder*  
Yung-Li Co. Ltd., Da Pu Industrial Zone, Cang Zi, Chang Ping Town, 523571 DONG GUAN CITY,  
Guangdong, CHINA

Aktenzeichen / *File ref.*  
1609800-5140-0005 / 171941 / FG42 / HEG

letzte Änderung / *updated* Datum / *Date*  
2012-09-25 2004-04-27

Dieses Blatt gilt nur in Verbindung mit Blatt 1 des Zeichengenehmigungsausweises Nr. 40010145  
*This supplement is only valid in conjunction with page 1 of the Certificate No. 40010145.*

**Starkstromleitungen für allgemeine Anwendungen**  
**- Flexible Leitungen**  
**mit thermoplastischer PVC-Isolierung**  
***Cables for general applications***  
**- Flexible cables with**  
***thermoplastic PVC insulation***

Typ(en) / *Type(s)*:

H03VV-F 2...4 x 0,5...0,75 mm <sup>2</sup>	+
H03VVH2-F 2 x 0,5...0,75 mm <sup>2</sup>	+
H05VV-F 2...5 x 0,75...4 mm <sup>2</sup>	+
H05VVH2-F 2 x 0,75...1,0 mm <sup>2</sup>	+

Leitungsbauart Standardleitungen  
*Type of cable General purpose cables*

Firmenzeichen YUNG LI  
*Trademark*

Dieser Zeichengenehmigungs-Ausweis bildet eine Grundlage für die EG-Konformitätserklärung und CE-Kennzeichnung durch den Hersteller oder dessen Bevollmächtigten und bescheinigt die Konformität mit den grundlegenden Schutzanforderungen der **EG-Niederspannungsrichtlinie 2006/95/EG** mit ihren Änderungen.

*This Marks Approval is a basis for the EC Declaration of Conformity and the CE Marking by the manufacturer or his agent and proves the conformity with the essential safety requirements of the EC Low-Voltage Directive 2006/95/EC including amendments.*

VDE Prüf- und Zertifizierungsinstitut GmbH  
*VDE Testing and Certification Institute*  
Fachgebiet FG42  
*Section FG42*

Name und Sitz des Genehmigungs-Inhabers / *Name and registered seat of the Certificate holder*

Yung-Li Co. Ltd., Da Pu Industrial Zone, Cang Zi, Chang Ping Town, 523571 DONG GUAN CITY,  
Guangdong, CHINA

Aktenzeichen / *File ref.*

1609800-5140-0005 / 171941 / FG42 / HEG

letzte Änderung / *updated* Datum / *Date*

2012-09-25

2004-04-27

Dieses Beiblatt ist Bestandteil des Zeichengenehmigungsausweises Nr. 40010145.

*This supplement is part of the Certificate No. 40010145.*

**Starkstromleitungen für allgemeine Anwendungen**

**- Flexible Leitungen**

**mit thermoplastischer PVC-Isolierung**

***Cables for general applications***

**- Flexible cables with**

***thermoplastic PVC insulation***

**Fertigungsstätte(n)**

***Place(s) of manufacture***

Referenz/*Reference*

**30008928**

Yung-Li Co. Ltd.

Da Pu Industrial Zone, Cang Zi

Chang Ping Town

523571 DONG GUAN CITY

Guangdong

CHINA

VDE Prüf- und Zertifizierungsinstitut GmbH

*VDE Testing and Certification Institute*

Fachgebiet FG42

*Section FG42*

Name und Sitz des Genehmigungs-Inhabers / *Name and registered seat of the Certificate holder*

Yung-Li Co. Ltd., Da Pu Industrial Zone, Cang Zi, Chang Ping Town, 523571 DONG GUAN CITY,  
Guangdong, CHINA

Aktenzeichen / *File ref.*

1609800-5140-0005 / 171941 / FG42 / HEG

letzte Änderung / *updated* Datum / *Date*

2012-09-25

2004-04-27

Dieses Blatt gilt nur in Verbindung mit Blatt 1 des Zeichengenehmigungsausweises Nr. 40010145  
*This supplement is only valid in conjunction with page 1 of the Certificate No. 40010145.*

**Genehmigung zum Benutzen des auf Seite 1 abgebildeten markenrechtlich geschützten Zeichens des VDE:**

Grundlage für die Benutzung sind die Allgemeinen Geschäftsbedingungen (AGB) der VDE Prüf- und Zertifizierungsinstitut GmbH ([www.vde.com\AGB-Institut](http://www.vde.com\AGB-Institut)). Das Recht zur Benutzung erstreckt sich nur auf die bezeichnete Firma mit den genannten Fertigungsstätten und die oben aufgeführten Produkte mit den zugeordneten Bezeichnungen. Die Fertigungsstätte muss so eingerichtet sein, dass eine gleichmäßige Herstellung der geprüften und zertifizierten Ausführung gewährleistet ist.

Die Genehmigung ist so lange gültig wie die VDE-Bestimmungen gelten, die der Zertifizierung zugrunde gelegen haben, sofern sie nicht auf Grund anderer Bedingungen aus der VDE Prüf- und Zertifizierungsordnung (PM102) zurückgezogen werden muss.

Der Gültigkeitszeitraum einer VDE-GS-Zeichengenehmigung kann auf Antrag verlängert werden. Bei gesetzlichen und / oder normativen Änderungen kann die VDE-GS-Zeichengenehmigung ihre Gültigkeit zu einem früheren als dem angegebenen Datum verlieren.

Produkte, die das Biozid Dimethylfumarat (DMF) enthalten, dürfen gemäß der Kommissionsentscheidung 2009/251/EG nicht mehr in den Verkehr gebracht oder auf dem Markt bereitgestellt werden.

Der VDE-Zeichengenehmigungsausweis wird ausschließlich auf der ersten Seite unterzeichnet.

***Approval to use the legally protected Mark of the VDE as shown on the first page:***

*Basis for the use are the general terms and conditions of the VDE Testing and Certification Institute ([www.vde.com\terms-institute](http://www.vde.com\terms-institute)). The right to use the mark is granted only to the mentioned company with the named places of manufacture and the listed products with the related type references. The place of manufacture shall be equipped in a way that a constant manufacturing of the certified construction is assured.*

*The approval is valid as long as the VDE specifications are in force, on which the certification is based on, unless it is withdrawn according to the VDE Testing and Certification Procedure (PM102E).*

*The validity period of a VDE-GS-Mark Approval may be prolonged on request. In case of changes in legal and / or normative requirements, the validity period of a VDE-GS-Mark Approval may be shortened.*

*Products containing the biocide dimethylfumarate (DMF) may not be marketed or made available on the EC market according to the Commission Decision 2009/251/EC.*

*The approval is solely signed on the first page.*