

13



LEZYNE™

WELCOME TO LEZYNE

YEAR 13 MECHANICAL

FLOOR PUMPS

PAGE 06

HAND PUMPS

PAGE 12

CO2 INFLATORS

PAGE 22

BELLS

PAGE 28

HYDRATION & BOTTLE CAGES

PAGE 29

SHOP TOOLS

PAGE 36

MULTI TOOLS

PAGE 42

TIRE REPAIR

PAGE 50

ORGANIZERS

PAGE 58



BECKY GARDNER



MECHANICAL YEAR 13

*"Pure function and clean aesthetics
are the essence of Lezyne."*

This quote by Lezyne's founder and president, Micki Kozuschek, couldn't ring more true when describing our collection of mechanical accessories. We create products that work and look great. It's as simple as that. And because each product is designed, developed and produced in-house, you're sure to be as happy with it as much as we were satisfied with making it.





GEOFF GULEVICH



SHOP FLOOR DRIVE

- Integrated handle storage cleanly houses V5 multi-tool, Power Levers and four glueless patches.
- Oversized 3.5" (89 mm) gauge.
- Aluminum handle, barrel and base. Steel piston.
- ABS1 Pro chuck.
- Extra long, high strength hose.

Black: 1-FP-STDR-V104, Silver: 1-FP-STDR-V106

V5 MULTI-TOOL



POWER LEVERS



PATCHES



STEEL FLOOR DRIVE

- Steel barrel and piston with machined aluminum base.
- 2.5" (63.5 mm) or oversized 3.5" (89 mm) gauge (220 psi / 15 bar).
- Varnished wood handle.
- Extra long, high strength hose.
- ABS1 Pro chuck.

3.5" Gauge: 1-FP-SFLDR-V704 (Black), 1-FP-SFLDR-V706 (Silver), 1-FP-SFLDR-V715 (Red), 1-FP-SFLDR-V716 (Yellow); Tall: 1-FP-SFLDR-V7T04 (Black)

2.5" Gauge: 1-FP-SFLDR-V604 (Black), 1-FP-SFLDR-V606 (Silver), 1-FP-SFLDR-V615 (Red), 1-FP-SFLDR-V616 (Yellow); Tall: 1-FP-SFLDR-V6T04 (Black)



SPORT FLOOR DRIVE

- Steel barrel and piston with Composite Matrix base.
- 2.5" (63.5 mm) or oversized 3.5" (89 mm) gauge (220 psi / 15 bar).
- Varnished wood handle.
- Extra long, high strength hose.
- ABS1 Pro chuck or Dual Valve chuck.

3.5" Gauge: 1-FP-SPFLDR-V504 (Black), 1-FP-SPFLDR-V506 (Silver), 1-FP-SPFLDR-V515 (Red), 1-FP-SPFLDR-V516 (Yellow); Tall: 1-FP-SPFLDR-V5T04 (Black)

2.5" Gauge: 1-FP-SPFLDR-V404 (Black), 1-FP-SPFLDR-V406 (Silver), 1-FP-SPFLDR-V415 (Red), 1-FP-SPFLDR-V416 (Yellow); Tall: 1-FP-SPFLDR-V4T04 (Black)

Dual Valve Chuck 3.5" Gauge: 1-FP-SPFLDR-V604 (Black), 1-FP-SPFLDR-V606 (Silver)

Dual Valve Chuck 2.5" Gauge: 1-FP-SPFLDR-V204 (Black), 1-FP-SPFLDR-V206 (Silver)



CNC DIGITAL DRIVE

- CNC machined aluminum construction.
- Precision digital gauge (220 psi / 15 bar).
- Extra long nylon reinforced braided hose with aluminum couplers.
- ABS1 Pro chuck.

Black: 1-FP-CNCDDR-V304, Silver: 1-FP-CNCDDR-V306



ALLOY DIGITAL DRIVE

- CNC machined aluminum barrel and base.
- Precision digital gauge (220 psi / 15 bar).
- Varnished wood handle with aluminum coupler.
- Extra long nylon reinforced braided hose with aluminum couplers.
- ABS1 Pro chuck.

Black: 1-FP-ADDR-V304, Silver: 1-FP-ADDR-V306



STEEL DIGITAL DRIVE

- Steel barrel & piston w/ machined aluminum base.
- Precision digital gauge (220 psi / 15 bar).
- Varnished wood handle.
- Extra long nylon reinforced braided hose with aluminum couplers.
- ABS1 Pro chuck.

Black: 1-FP-SDDR-V404, Silver: 1-FP-SDDR-V406



DIGITAL MACRO FLOOR DRIVE

- Steel barrel and piston.
- Precision digital gauge (220 psi / 15 bar).
- Composite matrix handle and base.
- Extra long, high strength hose.
- Available with ABS Flip-Thread chuck or Dual Valve

ABS Flip-Thread Chuck, Black: 1-FP-MAFLD-V104, Matte Black: 1-FP-MAFLD-V104M, Red: 1-FP-MAFLD-V115, Silver: 1-FP-MAFLD-V106
Dual Valve Chuck, Black: 1-FP-MAFLD-V204, Matte Black: 1-FP-MAFLD-V204M, Red: 1-FP-MAFLD-V215, Silver: 1-FP-MAFLD-V206



MACRO FLOOR DRIVE

- Steel barrel and piston.
- Composite matrix handle and base.
- Extra long, high strength hose.
- Available with ABS Flip-Thread chuck or Dual Valve

ABS Flip-Thread Chuck, Black: 1-FP-MAFL-V104, Matte Black: 1-FP-MAFL-V104M, Red: 1-FP-MAFL-V115, Silver: 1-FP-MAFL-V106
Dual Valve Chuck, Black: 1-FP-MAFL-V204, Matte Black: 1-FP-MAFL-V204M, Red: 1-FP-MAFL-V215, Silver: 1-FP-MAFL-V206



CNC FLOOR DRIVE

- CNC machined aluminum construction.
- Oversized 3.5-inch (89 mm) gauge (220 psi / 15 bar).
- Extra long nylon reinforced braided hose with aluminum couplers.
- ABS1 Pro chuck.

Black: 1-FP-CNCDR-V504, Silver: 1-FP-CNCDR-V506



SPORT DIGITAL DRIVE

- Steel barrel & piston w/ Composite Matrix base.
- Precision digital gauge (220 psi / 15 bar).
- Varnished wood handle.
- Extra long, high strength hose.
- ABS1 Pro chuck.

Black: 1-FP-SPDDR-V404, Silver: 1-FP-SPDDR-V406



CLASSIC FLOOR DRIVE

- Steel barrel & piston w/ machined aluminum base.
- Oversized 3.5-inch gauge (220 psi / 15 bar).
- Varnished wood handle.
- Extra long, high strength hose.
- ABS1 Pro chuck.

Black: 1-FP-CFLDR-V504, White: 1-FP-CFLDR-V507



ALLOY FLOOR DRIVE

- CNC machined aluminum barrel and base.
- Oversized 3.5-inch gauge (220 psi / 15 bar).
- Varnished wood handle with aluminum junction.
- Extra long, high strength hose.
- Anodized high polish finish.
- ABS1 Pro chuck.

Silver: 1-FP-AFLDR-V506, Black: 1-FP-AFLDR-V504
Tall, Silver: 1-FP-AFLDR-V5T06



SHOCK DIGITAL DRIVE

- CNC machined aluminum construction.
- Precision digital gauge (350 psi / 24.13 bar).
- Ultra-narrow barrel provides quick tuning up to 350 psi.
- Extra long nylon reinforced braided hose with aluminum couplers.
- Hardened steel ABS chuck with bleed button for fine tuning.
- Zero air loss disengagement system.

1-FP-SHDDR-V106



13



DIGITAL PRESSURE OVER DRIVE

- Integrated system to seat tubeless tires.
- Manually pressurized secondary chamber with a stainless steel foot release lever.
- Precision digital gauge (220 psi / 15 bar).
- Durable steel and aluminum construction.
- Extra long, high strength hose.
- ABS1 Pro chuck.

1-FP-PRODR-V204



PRESSURE OVER DRIVE

- Integrated system to seat tubeless tires.
- Manually pressurized secondary chamber with a stainless steel foot release lever.
- 2.5-inch (63.5 mm) gauge (220 psi / 15 bar).
- Durable steel and aluminum construction.
- Extra long, high strength hose.
- ABS1 Pro chuck.

1-FP-DPRODR-V204



CLASSIC OVER DRIVE

- Machined steel barrel and piston with aluminum base.
- High volume for plus sized tires.
- 2.5-inch (63.5 mm) gauge (60 psi / 4 bar).
- Extra long high strength oversized hose.
- High volume ABS1 Pro chuck.

1-FP-CLODR-V404



CNC TRAVEL FLOOR DRIVE

- Compact, lay-flat design.
- CNC machined aluminum construction.
- Durable anodized high-gloss finish.
- Compact 1.5-inch (38 mm) gauge (160 psi / 11 bar).
- ABS Flip-Thread chuck.
- Felt lined canvas bag included.

1-FP-TFLDR-V206



STEEL TRAVEL FLOOR DRIVE

- Compact, flat laying design.
- Steel barrel & piston w/ machined aluminum base.
- Varnished wood handle.
- Compact 1.5-inch (38 mm) gauge (160 psi / 11 bar).
- ABS Flip-Thread chuck.

1-FP-TFDRSD-V104



High Pressure
43g

High Volume
47g

ABS1 PRO

- CNC machined aluminum and Composite Matrix construction.
- Thread-on design.
- Chuck "flips" for Presta and Schrader compatibility.
- Integrated Presta valve-core tool.
- Self lubricating brass swivel.
- Ergonomic 90° design.

HP (Red): 1-ABS1P-CHUCK-V111
HV (Orange): 1-ABS1P-CHUCK-V220

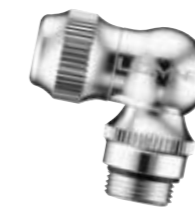

SLIP CHUCK

- Slip-fit, Presta only for ABS Flip-Thread chucks.
- CNC machined aluminum construction.
- Two-piece tool-free seal replacement design.
- Includes six replacement seals.

1-PRESTA-V1AL06



SPEED CHUCK

- Slip-fit, Presta only for ABS Flip-Thread chucks.
- Molded Composite Matrix construction.

1-RP-PRESTA-V1NY04



VALVE EXTENDERS

- 70 mm Presta valve extenders.
- CNC machined aluminum.
- Threaded tip.

1-RP-EXTDR-V1



DUAL VALVE HEAD

- Dual Valve chuck fits Presta, Schrader and Dunlop valves.
- Composite matrix construction.
- Aluminum locking lever.

1-DUAL-V104



ALISON TETRICK



MICRO FLOOR DIGITAL DRIVE HP

- 300 mm (11.8"), 208g / 160 psi, 11 bar.
- Portable pump with integrated highly accurate digital gauge.
- CNC machined aluminum barrel, piston, base and T-handle.
- Stainless steel footpeg creates floor pump-like operation.
- ABS Flip-Thread Chuck.
- Includes Composite Matrix frame mount.

Black: 1-MP-MFDR-V204HPDG, Silver: 1-MP-MFDR-V206HPDG



MICRO FLOOR DRIVE HPG/HP

- 300 mm (11.8"), 194g (HPG), 150g (HP) / 160 psi, 11 bar (HPG)
- Portable pump with integrated ABS Pen Gauge (HP version without gauge).
- CNC machined aluminum barrel, piston, base and T-handle.
- Stainless steel footpeg creates floor pump-like operation.
- ABS Flip-Thread Chuck.
- Includes Composite Matrix frame mount.

HPG, Black: 1-MP-MFDR-V204HPG, Silver: 1-MP-MFDR-V2HPG
HP, Black: 1-MP-MFDR-V204HV, Silver: 1-MP-MFDR-V2HV

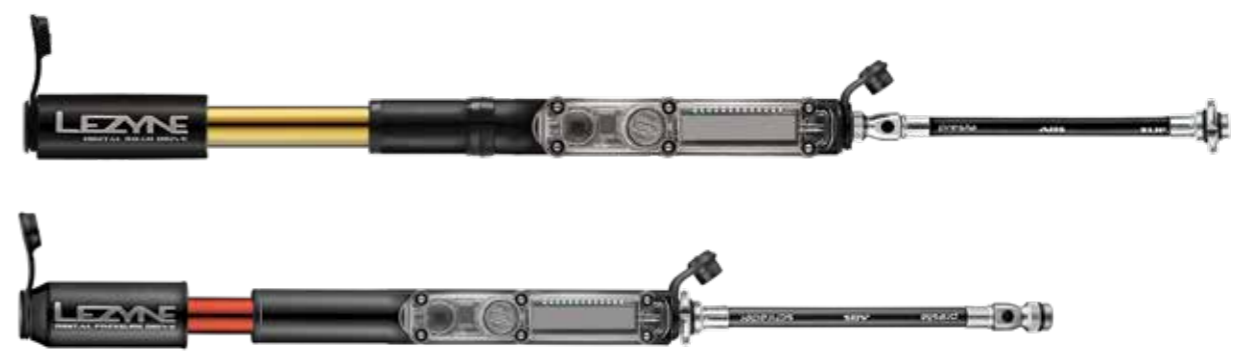

DIGITAL ROAD DRIVE

- 180 mm (7"), 117g / 160 psi, 11 bar.
- Integrated low profile, highly accurate digital gauge.
- CNC machined aluminum construction.
- Threaded or slip-fit Presta compatible ABS Flex Hose with integrated valve core tool.
- Includes alloy frame mount.
- Anodized black and gold (top image).
- Integrates with compatible Lezyne bottle cages.

1-MP-DRDDR-V1S04

DIGITAL PRESSURE DRIVE

- 170 mm (6.7"), 122g / 120 psi, 8.3 bar.
- Integrated low profile, highly accurate digital gauge.
- CNC machined construction.
- Presta and Schrader compatible ABS Flex Hose with integrated valve core tool.
- Includes Composite Matrix frame mount.
- Anodized black and red (bottom image).

1-MP-DPRDR-V1S04



LEFT TO RIGHT

CARBON ROAD DRIVE

- 180 mm (7"), 73g (S); 216 mm (8.5"), 83g (M) / 160 psi, 11 bar.
- Super light FCT (Full Carbon Tech) barrel and handle.
- CNC machined aluminum piston and hardware.
- Highly efficient design with overlapping handle.
- Threaded or slip-fit ABS Flex Hose / Integrated valve core tool.
- Includes FCT frame mount.
- Integrates with compatible Lezyne bottle cages.

Small: 1-MP-CBRDR-V3S05, Medium: 1-MP-CBRDR-V3M05

CARBON DRIVE LITE

- 170 mm (6.7"), 80g / 120 psi, 8.3 bar.
- MCT composite barrel and handle.
- CNC machined aluminum piston and hardware.
- Compact, highly efficient design with overlapping handle.
- Presta and Schrader valve compatible ABS Flex Hose with integrated valve core tool.
- Includes Composite Matrix frame mount.

1-MP-CDLHP-V1S05

GAUGE DRIVE HP

- 232 mm (9.1"), 119g / 120 psi, 8.3 bar.
- CNC machined aluminum barrel, handle and piston.
- Presta and Schrader valve compatible ABS Pen Gauge Flex Hose.
- Highly efficient design with overlapping handle.
- Includes Composite Matrix frame mount.

Black: 1-MP-GDHP-V1M04, Silver: 1-MP-GDHP-V1M06



Integrated Valve Core Tool



PRESSURE DRIVE

- 170 mm (6.7"), 89g (S); 216 mm (8.5"), 102g (M) / 120 psi, 8.3 bar.
- Full CNC machined aluminum construction and hardware with compact highly efficient overlapping handle.
- Presta and Schrader valve compatible ABS Flex Hose with integrated valve core tool.
- Includes Composite Matrix frame mount.

Small, Black: 1-MP-PRSDR-V2S04, Gold: 1-MP-PRSDR-V2S12, Red: 1-MP-PRSDR-V2S11, Blue: 1-MP-PRSDR-V2S10
Medium, Black: 1-MP-PRSDR-V2M04, Gold: 1-MP-PRSDR-V2M12, Red: 1-MP-PRSDR-V2M11, Blue: 1-MP-PRSDR-V2M10



LITE DRIVE

- 180 mm (7"), 80g (S); 219 mm (8.6"), 92g (M); 160 psi, 11 bar.
- CNC machined aluminum construction with compact, highly efficient overlapping handle.
- Presta and Schrader valve compatible ABS Flex Hose.
- Includes Composite Matrix frame mount.
- Integrates with compatible Lezyne bottle cages.

Small, Black: 1-MP-LTDR-V1S04, Silver: 1-MP-LTDR-V1S06, Red: 1-MP-LTDR-V1S11, Blue: 1-MP-LTDR-V1S10
Medium, Black: 1-MP-LTDR-V1M04, Silver: 1-MP-LTDR-V1M06, Red: 1-MP-LTDR-V1M11, Blue: 1-MP-LTDR-V1M10



ROAD DRIVE

- 180 mm (7"), 73g (S); 216 mm (8.5"); 283 mm (11.1"), 110g (L)
- 160 psi, 11 bar
- Full CNC machined aluminum construction and hardware with compact highly efficient overlapping handle.
- Threaded or slip-fit ABS Flex Hose / Integrated valve core tool.
- Includes Composite Matrix frame mount.
- Integrates with compatible Lezyne bottle cages.

Small, Black: 1-MP-RDDR-V2S04, Silver: 1-MP-RDDR-V2S06
Medium, Black: 1-MP-RDDR-V2M04, Silver: 1-MP-RDDR-V2M06
Large, Black: 1-MP-RDDR-V2L04, Silver: 1-MP-RDDR-V2L06



TECH DRIVE HP

- 170 mm (6.7"), 89g (S); 216 mm (8.5"), 102g (M) / 120 psi, 8.3 bar.
- CNC machined aluminum construction with compact, highly efficient overlapping handle.
- Presta and Schrader compatible ABS Flex Hose.
- Includes Composite Matrix frame mount.



HP DRIVE

- 170 mm (6.7"), 89g (S); 216 mm (8.5"), 102g (M) / 120 psi, 8.3 bar.
- CNC machined aluminum barrel (anodized) and piston.
- Overlapping Composite Matrix handle.
- Presta and Schrader valve compatible ABS Flex Hose.
- Includes Composite Matrix frame mount.

Small, Black: 1-MP-HPDR-V2S04, Silver: 1-MP-HPDR-V2S06, Red: 1-MP-HPDR-V2S11, Blue: 1-MP-HPDR-V2S10
 Medium, Black: 1-MP-HPDR-V2M04, Silver: 1-MP-HPDR-V2M06, Red: 1-MP-HPDR-V2M11, Blue: 1-MP-HPDR-V2M10



SPORT DRIVE HP

- 170 mm (6.7"), 89g (S); 216 mm (8.5"), 102g (M) / 120 psi, 8.3 bar.
- CNC machined aluminum barrel and piston.
- Overlapping Composite Matrix handle.
- Presta and Schrader valve compatible Flex Hose.
- Includes Composite Matrix frame mount.

Small, Black: 1-MP-SPDHP-V1S04, Light Grey: 1-MP-SPDHP-V1S19
 Medium, Black: 1-MP-SPDHP-V1M04



MICRO FLOOR DIGITAL DRIVE XL

- 302 mm (11.9"), 420g / 35 psi, 2.4 bar.
- Integrated highly accurate digital gauge.
- High-volume portable pump optimized for plus-size tire systems.
- CNC machined aluminum barrel, piston, base and T-handle.
- Stainless steel footpeg creates floor pump-like operation.
- Presta and Schrader compatible ABS Flip-Thread Chuck.

1-MP-MFDDR-XL-V104



MICRO FLOOR DIGITAL DRIVE HV

- 300 mm (11.8"), 150g / 90 psi, 6.2 bar.
- Portable pump with integrated highly accurate digital gauge.
- CNC machined aluminum barrel, piston, base and T-handle.
- Stainless steel footpeg creates floor pump-like operation.
- Presta and Schrader valve compatible ABS Flip-Thread Chuck.
- Includes Composite Matrix frame mount.

Black: 1-MP-MFDR-V204HVDG, Silver: 1-MP-MFDR-V206HVDG



DIGITAL SHOCK DRIVE

- 225 mm (8.9"), 110g / 350 psi, 24 bar.
- Integrated highly accurate digital gauge.
- Compact and lightweight aluminum construction.
- Designed for trailside or home use.
- Hose threads into handle.
- Zero-loss chuck design unthreads after valve pin seals.

1-MP-DSHKDR-V104



SHOCK DRIVE

- 260 mm (10.2"), 167g / 400 psi, 27.5 bar.
- Full CNC aluminum construction.
- Designed for trailside or home use.
- Diaphragm gauge.
- Hose threads into handle.
- Zero-loss chuck design unthreads after valve pin seals.

1-MP-SHKDR-V204



MICRO FLOOR DRIVE XL

- 302 mm (11.9"), 367g / 35 psi, 2.4 bar.
- CNC machined aluminum construction.
- Extra large high volume barrel optimized for plus-size tires.
- Stainless steel footpeg creates floor pump-like operation.
- Presta and Schrader valve compatible ABS Flip-Thread Chuck.

1-MP-MFDR-XL-V104



MICRO FLOOR DRIVE HVG/HV

- 300 mm (11.8"), 194g (HVG); 150g (HV) / 90 psi, 6.2 bar
- Portable pump with integrated gauge (HV version without gauge).
- CNC machined aluminum barrel, piston, base and T-handle.
- Stainless steel footpeg aids floor pump-like operation.
- Presta and Schrader valve compatible ABS Flip-Thread Chuck.

HVG, Black: 1-MP-MFDR-V204HVG, Silver: 1-MP-MFDR-V2HVG
 HV, Black: 1-MP-MFDR-V204HV, Silver: 1-MP-MFDR-V2HV



LANCE HAIDET



LEFT TO RIGHT

DIGITAL ALLOY DRIVE

- 216 mm (8.5"), 173g / 90 psi, 6.2 bar.
- Integrated highly accurate digital gauge.
- CNC machined aluminum construction with compact overlapping handle.
- Presta and Schrader valve compatible ABS Flex Hose with integrated valve core tool.

1-MP-DALDR-V1M04

GAUGE DRIVE HV

- 232 mm (12.7"), 142g / 90 psi, 6.2 bar.
- CNC machined aluminum barrel, handle and piston.
- Presta and Schrader valve compatible ABS Pen Gauge Flex Hose.
- Includes Composite Matrix frame mount.

Black: 1-MP-GDHV-V1M04, Silver: 1-MP-GDHV-V1M06

TECH DRIVE HV

- 170 mm (6.7"), 111g (S); 216 mm (8.5"), 127g / 90 psi, 6.2 bar.
- CNC machined aluminum barrel, handle, and piston.
- Compact overlapping handle.
- Presta and Schrader valve compatible ABS Flex Hose.
- Includes Composite Matrix frame mount.

Small, Black: 1-MP-TCHV-V1S04, Silver: 1-MP-TCHV-V1S06
Medium, Black: 1-MP-TCHV-V1M04, Silver: 1-MP-TCHV-V1M06

SPORT DRIVE HV

- 170 mm (6.7"), 100g / 90 psi, 6.2 bar.
- Machined aluminum barrel and piston.
- Presta and Schrader valve compatible Flex Hose.
- Includes Composite Matrix frame mount.

Black: 1-MP-SPDHV-V1S04, Silver: 1-MP-SPDHV-V1S06



ALLOY DRIVE

- 170 mm (6.7"), 112g (S); 216 mm (8.5"), 128g (M) / 90 psi, 6.2 bar.
- Full CNC machined construction and hardware.
- Compact, highly efficient design with overlapping handle.
- Presta and Schrader valve compatible ABS Flex Hose with integrated valve core tool.
- Includes Composite Matrix frame mount.

Small, Black: 1-MP-ALLDR-V2S04, Gold: 1-MP-ALLDR-V2S12, Red: 1-MP-ALLDR-V2S11, Blue: 1-MP-ALLDR-V2S10
Medium, Black: 1-MP-ALLDR-V2M04, Gold: 1-MP-ALLDR-V2M12, Red: 1-MP-ALLDR-V2M11, Blue: 1-MP-ALLDR-V2M10



HV DRIVE

- 170 mm (6.7"), 94g (S); 216 mm (8.5"), 109g (M) / 90 psi, 6.2 bar.
- CNC machined aluminum barrel (anodized) and piston.
- Overlapping Composite Matrix handle.
- Presta and Schrader valve compatible ABS Flex Hose.

Small, Black: 1-MP-HVDR-V2S04, Silver: 1-MP-HVDR-V2S06, Red: 1-MP-HVDR-V2S11, Blue: 1-MP-HVDR-V2S10
Medium, Black: 1-MP-HVDR-V2M04, Silver: 1-MP-HVDR-V2M06, Red: 1-MP-HVDR-V2M11, Blue: 1-MP-HVDR-V2M10



DIGITAL CHECK DRIVE

- 150 mm (5.9"), 60g / 350 psi, 24 bar
- Compact design with highly accurate digital gauge.
- Composite Matrix construction.
- Machined aluminum head.
- Presta or Schrader valve compatible flip-chuck.

1-GAUGE-DIGI-V1350



ABS PEN GAUGE

- 210 mm (8.3"), 32g
- ABS Flex Hose with integrated pressure gauge.
- Stores in handle of ABS Flex Hose equipped Lezyne hand pumps (medium and large sizes only).
- Presta and Schrader valve compatible ABS Flip-Thread Chuck.

1-RP-GAUGE-PENV2





BECKY GARDNER



PRESSURE DRIVE CFH

- Versatile 2-in-1 hand pump or CO2 inflator system.
- Integrated steel-braided hose doubles as a CO2 dispenser. Hose also sold separately.
- Pump features a CNC machined aluminum body, piston and handle.
- Presta and Schrader compatible Flip-Thread Chuck.
- Comes with one 16g CO2 cartridge and mounting hardware.
- Mounts to a frame or fits in a jersey pocket.
- Compatible with threaded CO2 only.

Black: 1-C2-PRCFH-V204 , Light Grey: 1-C2-PRCFH-V219
CO2 Flex Hose: 1-RP-CFH-HOSE

CFH MOUNTING OPTIONS:



Standard mounting option



Alternate mounting option (2nd CO2 sold separately)



ALLOY DRIVE CO2

- Durable CO2 dispenser constructed from CNC machined aluminum.
- Trigger Valve Operation for easy and controlled inflation.
- Twin Chuck head threads on to Presta and Schrader valves.
- Integrated canister stores one 16g CO2 cartridge.
- Canister insulates hands from cold during discharge.
- Compatible with threaded CO2 cartridges only.

Dispenser with 16g CO2 Cartridge, Black: 1-C2-ALDR-V104, Silver: 1-C2-ALDR-V106
Dispenser without Cartridge, Black: 1-C2-ALDR-V204, Silver: 1-C2-ALDR-V206



TRIGGER SPEED DRIVE CO2

- CNC machined aluminum dispenser with brass internals.
- Trigger Valve Operation for easy and controlled inflation.
- Slip Fit head presses onto Presta valve only.
- Neoprene sleeve insulates hands from cold during discharge.
- Available with one 16g CO2 or as a head only.
- Compatible with threaded CO2 cartridges only.

Head, Sleeve & 16g CO2 Cartridge, Black: 1-C2-TRSDR-V104, Silver: 1-C2-TRSDR-V106
Head & Sleeve only, Black: 1-C2-TRSDR-V204, Silver: 1-C2-TRSDR-V206



CONTROL DRIVE CO2

- CNC machined aluminum dispenser with brass internals.
- CNC control knob twists for easy and controlled inflation.
- Twin Slip Fit head presses onto Presta and Schrader valves.
- Neoprene sleeve insulates hands from cold during discharge.
- Available with one 16g or 25g CO2 or as a head only.
- Compatible with threaded CO2 cartridges only.

| | |
|----------------------------------|----------------------------------|
| Head, Sleeve & 16g CO2 Cartridge | Head, Sleeve & 25g CO2 Cartridge |
| Purple: 1-C2-CTRLDR-V121 | Purple: 1-C2-CTRLDR-V221 |
| Blue: 1-C2-CTRLDR-V110 | Blue: 1-C2-CTRLDR-V210 |
| Red: 1-C2-CTRLDR-V111 | Red: 1-C2-CTRLDR-V211 |
| Silver: 1-C2-CTRLDR-V106 | Silver: 1-C2-CTRLDR-V206 |
| Black: 1-C2-CTRLDR-V104 | Black: 1-C2-CTRLDR-V204 |

Head & Sleeve Only

| |
|--------------------------|
| Purple: 1-C2-CTRLDR-V321 |
| Blue: 1-C2-CTRLDR-V310 |
| Red: 1-C2-CTRLDR-V311 |
| Silver: 1-C2-CTRLDR-V306 |
| Black: 1-C2-CTRLDR-V304 |

25g



TRIGGER DRIVE CO2

- CNC machined aluminum dispenser with brass internals.
- Trigger Valve Operation for easy and controlled inflation.
- Twin Chuck head threads onto Presta and Schrader valves.
- Neoprene sleeve insulates hands from cold during discharge.
- Available with one 16g CO2 or as a head only.
- Compatible with threaded CO2 cartridges only.

| | |
|----------------------------------|------------------------|
| Head, Sleeve & 16g CO2 Cartridge | Head & Sleeve Only |
| Black: 1-C2-TRDR-V104 | Black: 1-C2-TRDR-V204 |
| Silver: 1-C2-TRDR-V106 | Silver: 1-C2-TRDR-V206 |
| Blue: 1-C2-TRDR-V110 | Blue: 1-C2-TRDR-V210 |
| Red: 1-C2-TRDR-V111 | Red: 1-C2-TRDR-V211 |





TWIN SPEED DRIVE CO2

- CNC machined aluminum dispenser with brass internals.
- Super compact, slip-on valve for quick inflation.
- Twin Slip Fit head presses onto Presta and Schrader valves.
- Neoprene sleeve insulates hands from cold during discharge.
- Available with one 16g or 25g CO2 or as a head only.
- Compatible with threaded CO2 cartridges only.

Head, Sleeve & 16g CO2 Cartridge, Black: 1-C2-TRSDR-V104, Silver: 1-C2-TRSDR-V106
 Head, Sleeve & 25g CO2 Cartridge, Black: 1-C2-TRSDR-V204, Silver: 1-C2-TRSDR-V206
 Head & Sleeve only, Black: 1-C2-TRSDR-V304, Silver: 1-C2-TRSDR-V306



16g

25g

TWIN KIT

- Compact, all-in-one CO2 and tire repair kit.
- Twin Speed Drive CO2 head.
- Two threaded CO2 cartridges (16g or 25g).
- Lever Kit (aluminum case + tire levers + six glueless patches).
- Custom neoprene and Velcro strap secures items together.
- Can be attached to seat posts.
- Fits neatly in most packs or jersey pockets.

16g: 1-C2-TWDRKIT-V204, 25g: 1-C2-TWDRKIT-V304



CO2 CARTRIDGES

- Threaded CO2 cartridges for use with all Lezyne or threaded CO2 inflators.
- 16g cartridges are compact and suitable for low volume/high pressure.
- 20g are suitable for medium volume/pressure.
- 25g are suitable for high volume or plus-sized tires.
- Available in 5-pack, 30-pack or in bulk (contact Lezyne for bulk pricing).

5 PACK, 16g: 1-C2-CRTDG-V116P5
 5 PACK, 20g: 1-C2-CRTDG-V120P5
 5 PACK, 25g: 1-C2-CRTDG-V125P5

Box 30 pcs, 16g: 1-C2-CRTDG-V116
 Box 30 pcs, 20g: 1-C2-CRTDG-V120
 Box 30 pcs, 25g: 1-C2-CRTDG-V125

Bulk Box 250 pcs, 16g: 1-C2-CRTDG-BULK-V116
 Bulk Box 220 pcs, 20g: 1-C2-CRTDG-BULK-V120
 Bulk Box 180 pcs, 25g: 1-C2-CRTDG-BULK-V125



16g

20g

25g

- Simple, versatile threaded CO2 cartridges available in three volumes.
- Compatible with all Lezyne CO2 dispensers.
- Suggested use: 16g - Road, 20g Gravel / Cross Country, 25g High Volume MTB / Plus Sized.



CADDY KIT

- Complete CO2 and tire repair kit in a simple, durable pouch.
- Caddy Sack (waterproof).
- Twin Speed Drive CO2 head.
- Two 16g CO2 cartridges.
- Smart Kit glueless patch kit.
- Power Levers.

1-C2-CADDYKIT-V1S04



REPAIR KIT

- Convenient CO2 and tire repair kit.
- Includes Twin Speed Drive CO2 head.
- Two threaded 16g CO2 cartridges.
- Power Levers.
- Smart Kit glueless patch kit.

1-C2-REPAIRKIT-V104



116g/20g



25g

CO2 SLEEVES

- Neoprene sleeves for CO2 cartridges.
- Protects fingers during CO2 discharge.
- Two sizes: 16g/20g or 25g cartridge compatibility

16g/20g Sleeve: 1-RP-CO2-SLV16-V1
 25g Sleeve: 1-RP-CO2-SLV25-V1



HYDRATION & BOTTLE CAGES



CLASSIC BRASS BELL

- Compact, classic bell shape construction in two sizes for a high quality sound.
- Bell and striker are made from high-polished brass (also available in black).
- Narrow machined aluminum base integrates into tight spots.
- Simple O-ring attachment mounts cleanly to a variety of tube sizes and shapes.
- Impressively loud ringtone.

BRASS/BLACK, S: 1-BL-CLBRS-V104S, BRASS/BLACK, M: 1-BL-CLBRS-V104M
 BRASS/SILVER, S: 1-BL-CLBRS-V106S, BRASS/SILVER, M: 1-BL-CLBRS-V106M
 ALL BLACK, S: 1-BL-CLBRS-V204S, ALL BLACK, M: 1-BL-CLBRS-V204M
 BOX (20) BRASS/BLACK, S: 1-BL-CLBRS-BOX-04S, BOX (16) BRASS/BLACK, M: 11-BL-CLBRS-BOX-04M
 BOX (20) ALL BLACK, S: 1-BL-CLBRS-BOX-B04S, BOX (16) ALL BLACK, M: 1-BL-CLBRS-BOX-B04M

CLASSIC SHALLOW BRASS BELL

- Modern, unique low-profile design.
- Bell and striker are made from high-polished brass.
- Narrow machined aluminum base integrates into tight spots.
- Simple O-ring attachment mounts cleanly to a variety of tube sizes and shapes.
- Definitely loud ringtone.

BRASS/BLACK: 1-BL-CLSBR-S-V104, BRASS/SILVER: 1-BL-CLSBR-S-V106
 BOX (11) BRASS/BLACK: 1-BL-CLSBR-S-BOX-04



NEW FLOW BOTTLE 650 / 750

- Traditional cycling water bottle with classic Lezyne styling.
- Optimized compatibility with Lezyne bottle cages.
- Taste free and BPA free materials.
- Leak-proof, high flow nozzle.
- Two sizes: 650 mL / 22 OZ or 750 mL / 26 OZ.

600 Foggy Clear: 1-WB-FLWB-V100S, 600 Smoke Grey: 1-WB-FLWB-V119S
750 Foggy Clear: 1-WB-FLWB-V100M, 750 Smoke Grey: 1-WB-FLWB-V119M



NEW CLASSIC STAINLESS BOTTLE

- Classic stainless steel water bottle with Lezyne branding.
- Insulated dual-wall construction. 470 mL / 16 OZ.
- Durable, rustproof and tasteless food grade materials.
- Wide mouth for quick filling and generous pouring/consumption.
- Sleek, high-end design with steel carrying handle.

1-WB-STLWB-V106



NEW FLOW THERMAL BOTTLE

- Insulated, double-wall cycling water bottle with classic Lezyne styling.
- Optimized compatibility with Lezyne bottle cages.
- Taste free and BPA free materials.
- Comfortable, high flow nozzle. Volume: 550 mL / 18.6 OZ.
- Keeps contents ice cold for many hours longer than traditional water bottles (time varies depending on outside temperature).

White: 1-WB-TRWB-V107, Grey: 1-WB-TRWB-V119



NEW CLASSIC FLASK

- Classic stainless steel flask.
- Traditional size offers excellent portability.
- Durable, long lasting stainless construction and design.
- Threaded lid with seal provides leak-free transport.
- 177 mL / 6 OZ.

1-WB-CFWB-V106



NEW FLOW TOOL CADDY PRO 79g

- Sleek, water bottle shaped organizer fits into standard bottle cages.
- Internal compartments organize cycling essentials.
- Soft, semi-rigid shell is durable and water resistant.
- Full zipper allows for 180° opening.
- Tools not included.

1-BC-FLWCA-V304



FLOW CADDY 60g

- Lightweight, rigid container that fits in standard bottle cages.
- Universal storage for essential roadside repair items.
- Water resistant screw on lid.
- Available with or without organizer sleeve.

Caddy only: 1-BC-FLWCADDY-V104
Caddy with Organizer: 1-BC-FLWCADDY-V204



FLOW STORAGE CAGE

- Durable fiber reinforced Composite Matrix construction.
- Optimized side-load design for easy access in compact frames.
- Available in right side configuration only.
- Integrated storage container.
- CO2 cartridge holder on both sides of the cage.
- Loaded Kit option: integrated storage container includes CO2 head, V16 multi-tool, Smart Kit glueless patch kit; CO2 cartridge holder has two included cartridges.

Loaded: 1-BC-FLSTL-V104, Loaded w/o CO2: 1-BC-FLSTL-V204, Unloaded: 1-BC-FLST-V104
*Loaded kit not available with CO2 cartridges in all countries.





Shown with bottle cage (not included).

TWIN SPEED DRIVE HEAD



V 5 MULTI-TOOL



2 x 16g CO2 CARTRIDGES



MATRIX LEVERS



FLOW STORAGE ADAPTER

- Integrated stainless steel storage bracket that fits under a bottle cage.
- Holds Twin Speed Drive CO2 head, V5 tool, two CO2 cartridges and two Matrix levers.

Loaded: 11-BC-STAD-V104, Loaded w/o CO2: 1-BC-STAD-V204
 *Loaded kit not available with CO2 cartridges in all countries.



ROAD DRIVE CARBON CAGE 39g

- Super light, incredibly strong Full Carbon Tech construction.
- Elegant one-piece design.
- Optimized shape securely holds bottles.
- Integrated pump mount for Road Drive and Lite Drive model hand pumps.
- Stylish matte unidirectional carbon finish.

White Graphic: 1-BC-RDCSLR-V2CB, Black Graphic: 1-BC-RDDRC-V3CB



CARBON CAGE SL-R 35g

- Super light, incredibly strong Full Carbon Tech construction.
- Optimized side-load design for easy access in compact frames.
- Available as right side configuration only.
- Engineered and tested to hold bottles securely.
- Stylish matte unidirectional carbon finish.

1-BC-RDCSLR-V2CB



CNC CAGE 39g

- Constructed entirely from CNC machined aluminum.
- Strong and lightweight heat-treated design.
- Sturdy ribs and top-catch secures a wide variety of bottles.

Black: 1-BC-CNCRC-V1AL04, Silver: 1-BC-CNCRC-V1AL06
 Purple: 1-BC-CNCRC-V1AL21, Red: 1-BC-CNCRC-V1AL11
 Blue: 1-BC-CNCRC-V1AL10



ALLOY CAGE 43g

- One-piece extruded aluminum construction.
- Strong and lightweight CNC machined, heat-treated design.
- Integrated pump mount for Road Drive and Lite Drive model pumps.
- Capably secures a wide variety of bottles.

Black: 1-BC-RDDRC-V1AL04, Silver: 1-BC-RDDRC-V1AL06
 Red: 1-BC-RDDRC-V1AL11, Blue: 1-BC-RDDRC-V1AL10





13



FLOW CAGE SL 48g

- Durable reinforced Composite Matrix construction.
- Optimized side-load design for easy access in compact frames.
- Available in left or right side configurations.
- Sold separately or in pairs (black and white only).

Enhanced:
 Black SL-L: 1-BC-FLSLL-V204, Black SL-R: 1-BC-FLSLR-V204
 White SL-L: 1-BC-FLSLL-V207, White SL-R: 1-BC-FLSLR-V207
 Purple SL-L: 1-BC-FLSLL-V221, Purple SL-R: 1-BC-FLSLR-V221
 Red SL-L: 1-BC-FLSLL-V211, Red SL-R: 1-BC-FLSLR-V211
 Blue SL-L: 1-BC-FLSLL-V210, Blue SL-R: 1-BC-FLSLR-V210
 Green SL-L: 1-BC-FLSLL-V203, Green SL-R: 1-BC-FLSLR-V203

Without Graphics:
 Black SL-L: 1-BC-FLSLL-V104, Black SL-R: 1-BC-FLSLR-V104
 White SL-L: 1-BC-FLSLL-V107, White SL-R: 1-BC-FLSLR-V107



FLOW CAGE HP 50g

- Durable fiber reinforced Composite Matrix construction.
- X-Grip cage design with dual upper catches holds bottles securely.
- Integrated mount and Velcro strap holds High Pressure model hand pumps.

Black: 1-BC-FLHP-V104, White: 1-BC-FLHP-V107



FLOW CAGE 48g

- Durable fiber reinforced Composite Matrix construction
- X-Grip cage design with dual upper catches holds bottle securely.

Black: 1-BC-FL-V104, White: 1-BC-FL-V107



POWER CAGE 66g

- Simple, lightweight aluminum tube construction.
- Stamped aluminum base is formed and welded to the tubing.
- Classic, wrap around design securely holds bottles over rough terrain.

Matte Black: 1-BC-POLE-V117, Red: 1-BC-POLE-V111
 Blue: 1-BC-POLE-V110, Silver: 1-BC-POLE-V106





CNC ROD

- Professional grade wrench handle with 32 mm hex opening.
- Durable CNC machined aluminum construction with high polish finish.
- Designed for use with our Two-Way bottom bracket and cassette tools.
- Machined set screw holds tools in place (tightened by hand or 6 mm hex).

1-ST-BAR-V106



EXBBT-CLT

- Forged, professional grade hardened steel.
- Two-Way integrated external bottom bracket, cassette and disc brake lock ring tool.
- For use with our 32 mm CNC Rod or 32 mm wrench.

External BB: Campagnolo, Chris King, FSA, Phil Wood, Shimano, SRAM/Truvativ, Etc.

Cassette Lock Ring: Shimano, SRAM, SunRace, SunTour, Chris King, Etc.

1-ST-EXBBT-CLT-V108



SPLBBT-NBBT

- Forged, professional grade hardened steel.
- Two-Way integrated ISIS Drive and 8-point bottom bracket tool.
- For use with our 32 mm CNC Rod or 32 mm wrench.

Splined/Notched BB: Race Face, Shimano, SRAM/Truvativ, Etc.

1-ST-SPLBB-NBB-V108



EXBBT-SOC

- Forged, professional grade hardened steel.
- External bottom bracket tool.
- For use with our 32 mm CNC Rod, an adjustable wrench or 3/8 socket drive.

External BB: Campagnolo, Chris King, FSA, Phil Wood, Shimano, SRAM, Truvativ, Etc.

1-ST-EXBBT-SOC-V108



CNC PEDAL ROD

- Heavy duty shop quality pedal wrench.
- CNC machined aluminum handle with durable chromoly head.
- Two 15 mm offset wrench openings positioned for optimum leverage.
- Replaceable head and handle.
- Integrated bottle opener.

1-ST-PW-V106



CNC CHAIN ROD

- Heavy duty shop quality chain whip with integrated lock ring tool.
- CNC machined aluminum handle with durable chromoly head.
- Custom Lezyne chain attached with stainless threaded bolts for easy replacement.
- Replaceable head and handle.
- Compatible with 7/8/9/10/11/12 speed cassettes.

1-ST-CW-V106



CLASSIC PEDAL ROD

- Shop quality pedal wrench.
- Varnished ergonomic wood handle with durable chromoly head.
- Two 15 mm offset wrench openings positioned for optimum leverage.
- Replaceable head and handle.
- Integrated bottle opener.

1-ST-CPW-V102



CLASSIC HEX ROD

- Chrome finish for superior style and function.
- Long leverage design with ergonomic wood handle.
- High strength chrome vanadium steel tool.
- Available in 6 mm and 8 mm hexes.
- Spherical tip on long end adds versatility.

6mm: 1-ST-HEX6-V106, 8mm: 1-ST-HEX8-V106



CLASSIC CHAIN ROD

- Shop quality chain whip with integrated lock ring tool.
- Varnished ergonomic wood handle with durable chromoly head.
- Custom Lezyne chain attached with stainless hardware for easy replacement.
- Replaceable head and handle.
- Compatible with 7/8/9/10/11/12 speed cassettes.

1-ST-CCW-V102



CLASSIC CHAIN DRIVE

- Ultimate shop quality chain breaker.
- Extra strong steel body.
- Ergonomic driver with aluminum handle.
- Hardened steel breaker pin with extra pin stored in handle.
- Adjustable design works with 7/8/9/10/11/12 speed chains.
- Classic wood handle.

1-MT-CCT1-05T04



CHAIN DRIVE

- Shop quality chain breaker.
- Durable cast and CNC machined steel body.
- Ergonomically contoured shape.
- Replaceable hardened steel breaker pin.
- Four integrated spoke wrenches (also removes breaker pin).
- Adjustable design works with 7/8/9/10/11/12 speed chains.
- Spare breaker pin included.

1-MT-CT1-05T04



11-SPEED CHAIN DRIVE

- Shop quality chain breaker compatible with 11/12 spd. chains.
- Campagnolo chain compatible.
- Durable cast and CNC machined steel body.
- Ergonomically contoured shape.
- Replaceable hardened steel breaker pin.
- Four integrated spoke wrenches (also removes breaker pin).
- Spare breaker pin included.

1-MT-CT11SP-V105T04



3-WAY SPOKE WRENCH

- Shop quality 3-way spoke wrench.
- Compact ergonomic design.
- Durable cast steel body.
- CNC machined slots.

1-ST-YSW-V106



3-WAY WRENCH

- Shop quality 3-way wrench.
- Two-piece serviceable body allows for easy bit exchange or replacement.
- Durable, CNC machined hardened steel body.
- Heavy duty, drawn and forged CRV+ anti-corrosion steel bits.
- Extra replacement bits included with each wrench.
- Not all bits interchangeable between bodies.

Hex 4/5/6mm: 1-ST-YHEXA-V106, Hex 2/2.5/3mm: 1-ST-YHEXB-V106
Torx T10/T25/T30: 1-ST-YTORXA-V106



HEX KIT

- Nine piece shop quality hex set.
- Ideal for the home or shop mechanic.
- High strength chrome vanadium with durable chrome finish.
- Folding holder with built in hanger holes to store on a pegboard.
- Hexes: 1.5, 2, 2.5, 3, 4, 5, 6, 8 and 10 mm.
- L-shaped with spherical tip.

1-ST-HEXKIT-V106





RATCHET KIT 140g

- Durable and compact chrome plated ratchet tool.
- Fine tooth ratchet with reversing lever.
- Fixed opening on opposite end.
- Tool selection optimized for road, gravel and mountain bikes.
- Super hard CRV (chrome vanadium) bits.
- Custom, machined aluminum extension adapter.
- Integrated magnet holds tool bits in place.
- Ratchet Kit comes in a compact, soft shell carrying case.
- Includes soft shell carrying case with storage cutouts.
- Bits included: Hex - 2, 2.5, 3, 4, 5, 6, 8 mm, Star Bits - T10, T25, T30, Phillips and Flathead bits

1-MT-RTDR-V106



TORQUE DRIVE 190g

- Pre-calibrated, torsion beam-style torque wrench.
- No preset necessary—simply twist until marker lines up with desired torque setting.
- Machined aluminum construction with removable handle.
- 2Nm – 10Nm torque capacity.
- Integrated magnet holds tool bits in place.
- Hex bits: 2, 2.5, 3, 4, 5, 6 mm.
- Star bits: T10, T25, T30.
- Phillips bit + Flathead bit.
- Includes soft shell carrying case with storage cutouts.

1-MT-TTDR-V104T12





SV 16

SV - MULTI TOOLS

SV 16: 125g SV 11: 105g
SV 10: 101g SV 7: 65g
SV 5: 50g

- Lightweight and low profile.
- Forged Center-Pivot stainless steel bits.
- Durable stainless steel fastening hardware.
- SV 10 & 11: Aluminum chain breaker.
- SV 16: Cast stainless steel chain breaker with integrated spoke wrenches.
- SV 16: Integrated magnetic quick link holder.



SV 10

SV 5



SV 11



SV 7



SV 16: 1-MT-SV-16T06, SV 11: 1-MT-SV-11T06
SV 10: 1-MT-SV-10T06, SV 7: 1-MT-SV-07T06
SV 5: 1-MT-SV-05T06



V 16

V - MULTI TOOLS

V 16: 125g V 11: 105g
V 10: 101g V 7: 65g
V 5: 50g

- Lightweight and low profile.
- CNC machined aluminum side plates.
- Forged Center-Pivot CrV+ anti-corrosion bits.
- Chrome Vanadium steel fastening hardware.
- V 10 & 11: Aluminum chain breaker.
- V 16: Cast stainless steel chain breaker with integrated spoke wrenches.
- V 16: Integrated magnetic quick link holder.



V 10

V 5



V 11



V 7



V 16 - Black: 1-MT-V-16T04
V 11 - Red/Black: 1-MT-V-11T11, Blue/Black: 1-MT-V-11T10, Black: 1-MT-V-11T04
V 10 - Red/Black: 1-MT-V-10T11, Blue/Black: 1-MT-V-10T10, Black: 1-MT-V-10T04
V 7 - Red/Black: 1-MT-V-07T11, Blue/Black: 1-MT-V-07T10, Black: 1-MT-V-07T04
V 5 - Red/Black: 1-MT-V-05T11, Blue/Black: 1-MT-V-05T10, Black: 1-MT-V-05T04
(Blue/Black color not available in the U.S.A.)

SV, V TOOL BIT KEY:

MODEL: 16

- HEX TOOL: 2, 2.5, 3, 4, 5, 6, 8 mm
- ★ STAR-SHAPED TOOL: T25, T30
- ⊖ FLAT HEAD TOOL
- ⌘ CHAIN BREAKER: 8/9/10/11/12 speed
- 🔧 TIRE LEVER: Open End 10 mm
- 🔧 SPOKE WRENCHES: Mavic Mtb, 3.22, 3.45
- ⌘ QUICK LINK HOLDER

MODEL: 11

- HEX TOOL: 2, 2.5, 3, 4, 5, 6, 8 mm
- ★ STAR-SHAPED TOOL: T25, T30
- ⊖ FLAT HEAD TOOL
- ⌘ CHAIN BREAKER: 8/9/10/11/12 speed

MODEL: 10

- HEX TOOL: 2, 3, 4, 5, 6, 8 mm
- ★ STAR-SHAPED TOOL: T25, T30
- ⊕ PHILLIPS HEAD TOOL
- ⌘ CHAIN BREAKER: 8/9/10/11 speed

MODEL: 7

- HEX TOOL: 3, 4, 5, 6 mm
- ★ STAR-SHAPED TOOL: T25, T30
- ⊖ FLAT HEAD TOOL

MODEL: 5

- HEX TOOL: 3, 4, 5, 6 mm
- ⊕ PHILLIPS HEAD TOOL



T-DRIVE 153g

- Machined aluminum construction.
- Removable handle.
- Integrated magnet holds tool bits in place.
- Hex bits: 2, 2.5, 3, 4, 5, 6, 8 mm.
- Star bits: T10, T25, T30.
- Phillips bit.
- Flathead bit.
- Includes soft shell carrying case with storage cutouts.

1-MT-TDR-V104T12



STORAGE DRIVE 77g

- Machined aluminum construction.
- Storage for bits in the handle.
- Integrated magnet holds tool bits in place.
- Hex bits: 4, 5, 6 mm.
- Star bits: T25, T30.
- Includes strap for on-the-bike mounting.

1-MT-STR-V104T5



STAINLESS 20



STAINLESS 19

STAINLESS - MULTI TOOLS

STAINLESS 20: 161g
STAINLESS 19: 150g
STAINLESS 12: 115g

- Optimized for mountain bikers and gravel riders.
- Easy to grip forged aluminum side plates.
- Forged Center-Pivot stainless steel bits.
- Durable stainless steel fastening hardware.
- Forged aluminum chain breaker with three integrated spoke wrenches.
- Serrated knife (STL 20 only).

STL 20: 1-MT-STL-20T06, STL 19: 1-MT-STL-19T06, STL 12: 1-MT-STL-12T06

STAINLESS 12



CRV 20



CRV 19

CRV - MULTI TOOLS

CRV 20: 161g
CRV 19: 150g
CRV 12: 115g

- Optimized for mountain bikers and gravel riders.
- Easy to grip forged aluminum side plates.
- Forged Center-Pivot CrV+ anti-corrosion steel bits.
- Chrome Vanadium steel fastening hardware.
- Cast stainless steel chain breaker with three integrated spoke wrenches.
- Serrated knife (CRV 20 only).

CRV 20: 1-MT-CRV-20T04, CRV 19: 1-MT-CRV-19T04, CRV 12: 1-MT-CRV-12T04

CRV 12

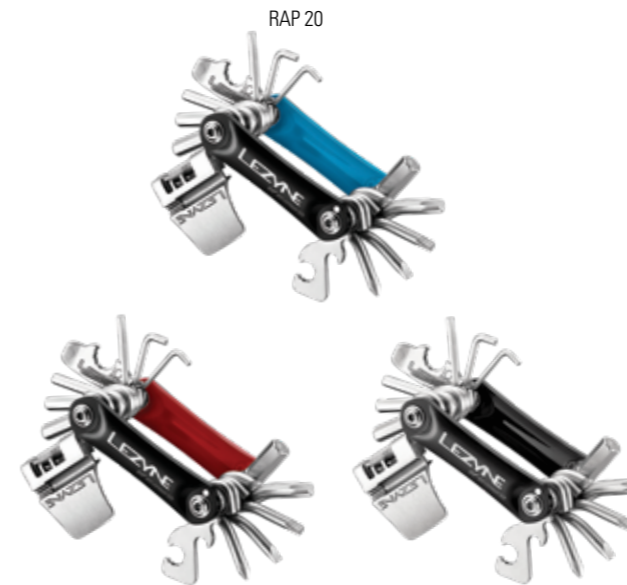

RAP 20

RAP 14



RAP 6



RAP - MULTI TOOLS

RAP 20: 178g RAP 14: 149g
RAP 6: 74g

- Ergonomic forged aluminum side plates.
- Forged and wrapped Center-Pivot CrV+ anti-corrosion steel bits.
- Chrome Vanadium steel fastening hardware.
- Cast stainless steel chain breaker with three integrated spoke wrenches (RAP 14 and 20).

RAP 20 - Blue: 1-MT-RAP-V220T10, Red: 1-MT-RAP-V220T11, Black: 1-MT-RAP-V220T04
RAP 14 - Blue: 1-MT-RAP-V214T10, Red: 1-MT-RAP-V214T11, Black: 1-MT-RAP-V214T04
RAP 6 - Blue: 1-MT-RAP-V206T10, Red: 1-MT-RAP-V206T11, Black: 1-MT-RAP-V206T04
(Blue color not available in the U.S.A.)



RAP 21 CO2

RAP 15 CO2



RAP CO2 - MULTI TOOLS

RAP 21: 178g
RAP 15: 149g

- Forged and wrapped Center-Pivot CrV+ anti-corrosion steel bits.
- Integrates our CO2 chuck on the 5 mm bit.
- Presta and Schrader compatible lightweight aluminum CO2 dispenser.
- Available in 15 or 21 tool configurations.

RAP 21 CO2 - Blue: 1-MT-RAP-V321T10, Red: 1-MT-RAP-V321T11, Black: 1-MT-RAP-V321T04
RAP 15 CO2 - Blue: 1-MT-RAP-V315T10, Red: 1-MT-RAP-V315T11, Black: 1-MT-RAP-V315T04
(Blue color not available in the U.S.A.)

STAINLESS & CRV TOOL BIT KEY:

MODEL: 20 (MODEL 19 IS THE SAME BUT W/O KNIFE)

- HEX TOOL: 2, 2.5, 3, 4, 5, 6, 8 mm
- STAR-SHAPED TOOL: T25
- PHILLIPS AND FLAT HEAD TOOL
- CHAIN BREAKER: 8/9/10/11/12 speed
- SPOKE WRENCHES: Mavic Mtb, 3.22, 3.45
- SERRATED KNIFE: 60 mm (MODEL 20 Only)
- TIRE LEVER: Open End 10 mm
- BOTTLE OPENER: Open End 8 mm Disc Brake Wedge

MODEL: 12

- HEX TOOL: 2, 3, 4, 5, 6, 8 mm
- STAR-SHAPED TOOL: T25
- PHILLIPS HEAD TOOL
- CHAIN BREAKER: 8/9/10/11 speed
- SPOKE WRENCHES: Mavic Mtb, 3.22, 3.45

RAP TOOL BIT KEY:

MODELS: 21, 20

- HEX TOOL: 2, 2.5, 3, 4, 5, 6, 8 mm
- STAR-SHAPED TOOL: T25, T30
- PHILLIPS AND FLAT HEAD TOOL
- CHAIN BREAKER: 8/9/10/11/12 speed
- SPOKE WRENCHES: Mavic Mtb, 3.22, 3.45

- TIRE LEVER: Open End 10 mm
- BOTTLE OPENER: Open End 8 mm Disc Brake Wedge
- CO2 TOOL TIP (Model 21 only)

MODELS: 15, 14

- HEX TOOL: 2, 3, 4, 5, 6, 8 mm
- STAR-SHAPED TOOL: T25, T30
- PHILLIPS HEAD TOOL
- CHAIN BREAKER: 8/9/10/11 speed
- SPOKE WRENCHES: Mavic Mtb, 3.22, 3.45
- CO2 TOOL TIP (Model 15 only)

MODEL: 6

- HEX TOOL: 3, 4, 5, 6 mm
- STAR-SHAPED TOOL: T25
- PHILLIPS HEAD TOOL









BLOX 23 - MULTI TOOL 230g

- Shop quality multi-tool in a portable size.
- CNC machined aluminum side plates.
- Extra long forged CrV+ anti-corrosion steel bits.
- Cast stainless steel chain breaker with three integrated spoke wrenches.

1-MT-BLX-V123T06

BLOX 23 TOOL BIT KEY:

BLOX 23:

-  HEX TOOL: 2, 2.5, 3, 4, 5, 6, 8 mm
-  L-HEX TOOL: 2, 2.5, 3 mm
-  STAR-SHAPED TOOL: T25, T30
-  PHILLIPS & FLAT HEAD TOOL
-  SPOKE WRENCHES: Mavic Mtb, 3.22, 3.45
-  TIRE LEVER: Open End 10 mm
-  CHAIN BREAKER: 8/9/10/11/12 speed
-  BOTTLE OPENER: Open End 8 mm
Disc Brake Wedge

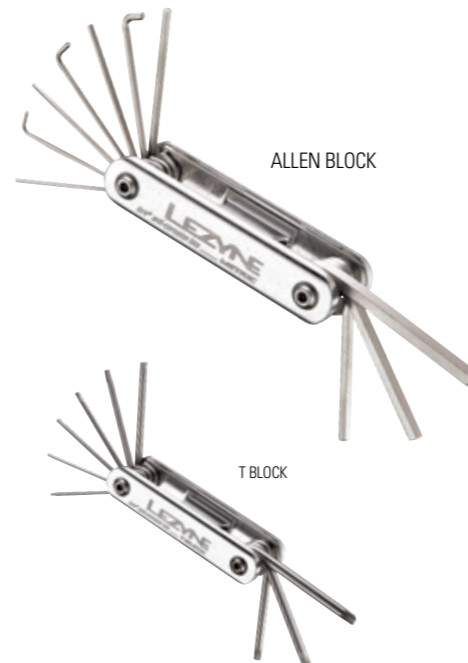

BLOCK - MULTI TOOLS

ALLEN BLOCK: 130g



T BLOCK: 125g

- Shop quality multi-tool in a portable size.
- CNC machined aluminum, extremely rigid one-piece I-Beam body.
- Extra long forged CrV+ anti-corrosion steel bits.
- Select L-Bend bits included for hard to reach fasteners.

Allen Block: 1-MT-ABK-10T06
T Block: 1-MT-TBK-09T06

BLOCK TOOL BIT KEY:

ALLEN BLOCK:

-  HEX TOOL: 1.5, 2, 2.5, 3, 4, 5, 6 mm
-  L-HEX TOOL: 1.5, 2, 2.5 mm

T BLOCK:

-  STAR-SHAPED TOOL: T6, T7, T9, T10, T15, T20, T25, T27, T30



PORT-A-SHOP PRO

- Professional level portable cycling tool kit.
- Equipped with Lezyne shop quality tools.
- Durable, composite case with sturdy foam interior and labeled tool slots.
- Spare pocket for extra tools or personal items.

1-SP-PORTAPRO-V204

INCLUDED TOOLS:

- Hex Kit
- 3 Way Allen 4/5/6
- 3 Way Spoke Wrench
- CNC Rod
- Classic Hex 6mm
- Cassette Tool
- Torx Block
- 3 Way Allen 2/2.5/3
- Classic Chain Drive
- Classic Chain Rod
- Classic Hex 8mm
- Smart Kit (5 patches)
- 3 Way Wrench Star
- Power Lever XL
- Classic Pedal Rod
- Splined BB Tool



PORT-A-SHOP

- Medium sized cycling specific tool kit designed for traveling.
- Convenient, padded canvas carrying case with zipper closure.
- Labeled organizational pockets.
- Equipped with Lezyne quality essential bicycles tools.

1-SP-PORTA-V104

INCLUDED TOOLS:

- T Block
- Multi Block
- Allen Block
- Smart Kit
- Classic Kit
- Chain Drive
- Saber Levers
- Power Levers



PORT-A-SHOP SMALL

- Small cycling specific tool kit designed for traveling.
- Convenient, padded canvas carrying case with zipper closure.
- Labeled organizational pockets.
- Equipped with Lezyne quality essential bicycles tools.

1-SP-PORTA-V204S

INCLUDED TOOLS:

- T Block
- Multi Block
- Allen Block
- Chain Drive
- Power Levers



Scan QR code for Tubless CO2 Blaster tutorial.

TUBELESS CO2 BLASTER

- Innovative 2-in-1 cycling CO2 dispenser and tubeless tire repair kit simultaneously inflates and seals tubeless tires.
- Lightweight and durable CNC machined aluminum construction.
- Hardened steel reamer scours hole, inserts plug and inflates tire for an efficient and rapid repair.
- CNC-machined twist knob manually controls release of CO2 gas.
- Aluminum canister holds the five included tire plugs and safely stores the reamer when not in use.
- High quality tire plugs aggressively seal holes.
- Sleek, compact design fits in a pocket or straps to a bike.
- Two kit options: With or without two 20g CO2 cartridges
- Includes a simple, versatile Velcro mounting strap.

Without CO2: 1-PK-TBC2-V204, With CO2: 1-PK-TBC2-V104



TUBELESS KIT

- Compact tubeless tire repair kit.
- Machined aluminum storage tube doubles as a handle.
- Combined tire reamer and insertion tool.
- Includes five high quality tire plugs.
- Available individually or in a countertop box (24 pcs).

1-PK-TBLS-V104, Countertop Box: 1-PK-TBLS-V1BOX



CLASSIC TUBELESS KIT

- Portable tubeless tire repair kit.
- Machined aluminum T-handle.
- Combined tire reamer and insertion tool.
- Includes five high quality tire plugs.
- Available individually or in a countertop box (24 pcs).

1-PK-CTBLS-V106, Countertop Box: 1-PK-CTBLS-V1BOX



LEVER KIT

- Integrated patch kit and tire lever combo.
- Aluminum case holds patches, and tire levers serve as press-fit end caps.
- Six highly adhesive glueless patches.
- Two durable Composite Matrix tire levers.
- Includes tire boot and stainless steel scuffer.
- Available individually or in a countertop box (24 pcs).

Grey: 1-PK-LEVER-V16P, Black: 1-PK-LEVER-V104
 Blue: 1-PK-LEVER-V110, Red: 1-PK-LEVER-V111
 Gold: 1-PK-LEVER-V112, Box: 1-PK-LEVER-BOX24-V2
 (Blue color not available in U.S.A.)



METAL KIT

- Waterproof case with rubber end caps.
- Six highly adhesive glueless patches.
- Includes tire boot and stainless steel scuffer.
- Available individually or in a countertop box (24 pcs).

Grey: 1-PK-METAL-V16P, Black: 1-PK-METAL-V104
 Blue: 1-PK-METAL-V110, Red: 1-PK-METAL-V111
 Gold: 1-PK-METAL-V112, Box: 1-PK-METAL-BOX24-V2
 (Blue color not available in U.S.A.)



SMART KIT

- Ultra compact polypropylene case.
- Six highly adhesive glueless patches.
- Includes tire boot and stainless steel scuffer.
- Available individually or in a countertop box (34 pcs).

1-PK-SMART-V16P, Countertop Box: 1-PK-SMART-V1BOX



CLASSIC KIT

- Traditional style patch kit.
- Rubber adhesive (7 cc)
- Includes six round and two oval patches.
- Includes tire boot and stainless steel scuffer.
- Available individually or in a countertop box (24 pcs).

1-PK-CLKIT-V18P, Countertop Box: 1-PK-CLKIT-V1BOX





SABER LEVER

- Constructed from forged, heat treated and CNC machined steel.
- Heavy duty 150 mm high-leverage tire lever with aggressive hook design.
- 15 mm pedal wrench (combine two to remove 15 mm nuts).
- Bottle opener.
- Sold as a pair.

1-TL-SABER-V200



ALLOY LEVER

- Constructed from forged aerospace grade aluminum.
- Compact and aggressive dual hook design.
- Sold as a pair.

1-TL-ALLOY-V1HD06



MATRIX LEVERS

- Strong, fiber reinforced Composite Matrix levers.
- Aggressive dual hook design.
- Available as individual pairs or in a countertop box (30 pairs).

Black: 1-TL-MTRX-V1NL04, White: 1-TL-MTRX-V1NL07
Countertop Box, Black: 1-TL-MTRX-V2BOX04
Countertop Box, White: 1-TL-MTRX-V2BOX07



POWER LEVERS

- Strong, fiber reinforced Composite Matrix levers.
- Aggressive hook design suitable for all tire types.
- Comfortable, wide handle with integrated spoke hook that locks levers together.
- Available as pairs or in a countertop box (30 pairs).

Black: 1-TL-POWR-V1NL04, White: 1-TL-POWR-V1NL07
Countertop Box, Black: 1-TL-POWR-V1BOX04
Countertop Box, White: 1-TL-POWR-V1BOX07



POWER LEVERS XL

- Strong, fiber reinforced Composite Matrix levers.
- Aggressive hook design suitable for all tire types.
- Extra long 148 mm length for increased leverage.
- Comfortable, wide handle with interlocking spoke hook.
- Available as pairs or in a countertop box (30 pairs).

Black: 1-TL-POWRXL-V1NL04, Yellow: 1-TL-POWRXL-V1NL16
Countertop Box, Black: 1-TL-POWRXL-V1BOX04
Countertop Box, Yellow: 1-TL-POWRXL-V1BOX16



BECKY GARDNER



NEW SHOULDER PACK 200g

- 4.8 L Capacity.
- Lightweight, minimalistic single strap cycling pack.
- Comfortable and great for simple on or off the bike use.
- Water resistant, durable diamond structured polyester main construction with breathable mesh backing.
- Reflective secondary pocket for added visibility and additional storage.
- Large main pocket with internal separator sleeve.
- External, easy access water bottle holder.
- External loops to clip LED lights to, or hang sunglasses from.

1-SB-SHODRPK-V104



NEW SEDIT CADDY 39g

- Lightweight, versatile cycling organizer quickly and securely straps to frame or seat post.
- Three labeled compartments keeps gear and tools organized and secure on the roughest trails.
- Perfect for carrying tire repair items on frames with limited space.
- Durable, high quality materials.
- Rubberized elastics for added grip.
- Strap is capable of holding up to one 25g CO2 cartridge and a 29" mountain bike tube, plus a small multi tool and tire levers.
- Tools not included.

1-SB-SDCADDY-V104



AERO CADDY 106g

- 1.1 L Capacity.
- Semi-large sized saddle bag.
- Curved design tucks neatly behind saddle.
- Internal insert helps keeps contents organized.
- Internal mesh pocket/organizer.
- Built in key hook.

1-SB-ARCADDY-V104



MID CADDY 95g

- 0.8 L Capacity.
- Durable medium sized saddle bag.
- Weather proof roll-top enclosure with securing strap.
- Internal pockets to organize money, tools and tire repair items.
- Ideal for mountain and gravel bikes.

1-SB-MDCADDY-V104



MICRO CADDY S/M

S: 80g M: 90g

- Small: 0.2 L Capacity / Medium: 0.3 L Capacity
- Compact, aero shaped saddle bag.
- Elastic nylon strap secures caddy to the seat rails.
- Printed internal pockets to organize money, tools and tire repair items.
- Reflective logos and loop increases visibility.
- Water resistant.
- High contrast red/black, or black only.

Red/Black: S: 1-SB-CADDY-V1MCS11, M: 1-SB-CADDY-V1MCM11
Black: S: 1-SB-CADDY-V1MCS04, M: 1-SB-CADDY-V1MCM04



S CADDY 60g

- 0.3 L Capacity.
- Small, wedge shaped saddle bag.
- Velcro straps attach to saddle rails and seat post.
- Printed internal pockets to organize money, tools and tire repair items.
- Reflective logos and loop increases visibility.
- Water resistant zipper with large pull loop.
- High contrast red/black, or black only.

Red/Black: 1-SB-CADDY-V1S11
Black: 1-SB-CADDY-V1S04



M CADDY 75g

- 0.4 L Capacity
- Medium, wedge shaped saddle bag.
- Velcro straps attach to saddle rails and seat post.
- Printed internal pockets to organize money, tools and tire repair items.
- LED light mount loop.
- Reflective logos and loop increases visibility.
- Water resistant.
- High contrast red/black, or black only.

Red/Black: 1-SB-CADDY-V1M11
Black: 1-SB-CADDY-V1M04



POD CADDY M 135g

- 0.8 L Capacity.
- Molded EVA foam, semi-rigid construction with QR Mounting System.
- Durable woven nylon cover with extra wide clamshell opening.
- Internal mesh divider keeps contents in place.
- Reflective piping increases visibility.
- Water resistant.

1-SB-PCADDY-V1M04



M CADDY QR 115g

- 0.4 L Capacity.
- Medium sized, wedge-shaped design with QR Mounting System.
- Durable woven nylon construction.
- Printed internal pockets to organize money, tools and tire repair items.
- External multi-tool sleeve.
- Reflective logos and loop increases visibility.
- Water resistant.

1-SB-CADDY-V1MQR04



MICRO CADDY S/M QR

S: 120g M: 130g

- Small: 0.2 L Capacity / Medium: 0.3 L Capacity
- Compact aero-shaped design with QR Mounting System.
- Printed internal pockets to organize money, tools and tire repair items.
- External multi-tool sleeve.
- Reflective piping increases visibility.
- LED light mount loop.
- Water resistant.

Small: 1-SB-CA-V1MCSQR04, Medium: 1-SB-CA-V1MCMQR04



L CADDY 115g

- 1.2 L Capacity.
- Large capacity, wedge-shaped saddle bag.
- Velcro straps attach to saddle rails and seat post.
- Printed internal pockets to organize money, tools and tire repair items.
- External sub compartment for multi-tool.
- LED light mount strip.
- Reflective logos and loop increases visibility.
- Water resistant.
- New high contrast red/black or black only.

Red/Black: 1-SB-CADDY-V1L1, Black: 1-SB-CADDY-V1L04



EX CADDY 115g

- 0.8 L Capacity.
- Expandable wedge-shaped saddle bag.
- Buckle system attaches to saddle rails and seat post.
- Durable woven nylon construction.
- Printed internal pockets to organize money, tools and tire repair items.
- Reflective logos and loop increases visibility.
- Water resistant.

1-SB-CADDYEX-V1M04



M CADDY - CO2 KIT 245g

- M Caddy saddle bag.
- Twin Speed Drive CO2 head.
- Two 16g CO2 cartridges.
- RAP 6 multi-tool
- Smart Kit glueless patch kit.
- Matrix Levers.

1-SB-CADLD-V3M04



M CADDY - SPORT KIT 274g

- M Caddy saddle bag.
- Sport Drive HP hand pump.
- RAP 6 multi-tool.
- Smart Kit glueless patch kit.
- Matrix Levers.

1-SB-CADLD-V2M04



FRAME CADDY 284g

- 2.5 L Capacity.
- Large capacity frame pack.
- Adjustable mounting straps.
- Highly water resistant with protected zipper enclosure.
- Complements current touring/bike packing setups.
- Fits most frames.

1-CS-FRAME-V104



BAR CADDY 263g

- 7 L Capacity.
- Medium capacity handlebar bag.
- Easy access, double sided roll-type enclosures.
- Highly water resistant, compressible design.
- High quality, durable materials.
- Adjustable straps and simple Velcro mounting system.
- Extra draw cords to hold additional gear.
- Reflective features and light mounts for added safety.

1-SB-BCADDY-V104



ROLL CADDY 115g

- 0.4 L Capacity.
- Expandable saddle bag with Velcro roll closure.
- Single removable Velcro strap attaches to saddle rails.
- Printed internal pockets to organize money, tools and tire repair items.
- Reflective logos and loop increases visibility.
- Water resistant.

1-SB-RUCADDY-V104



ROAD CADDY 115g

- 0.4 L Capacity.
- Medium capacity saddle bag.
- Single Velcro strap secures to saddle rails.
- Durable woven nylon construction.
- Main compartment with organizational pockets.
- LED light mount loop.
- Reflective logos and loop increases visibility.
- Water resistant.

1-SB-RDCADDY-V104



ROAD CADDY XL 142g

- 1.5 L Capacity
- Extra large, simply designed saddle bag.
- Long adjustable strap balances contents and easily attaches to seat rails.
- Single zipper, extra wide opening.
- LED light mount loop.
- Reflective logos and loop increases visibility.
- Water resistant.

1-SB-RDCADDYXL-V104



XL CADDY 434g

- 7.5 L Capacity.
- Extra large adventure style seat bag.
- Two individual Velcro straps securely mounts to seat rails.
- Single strap mounts to seat post to keep bag stable.
- Roll-style enclosure provides easy access and compresses gear.
- Highly water resistant.
- Removable internal sidewall supports.
- Reflective features and light mounts for additional safety.

1-SB-CADDY-V2XL04



STUFF CADDY 76g

- 1.3 L Capacity.
- Simple, versatile caddy with multiple mount options to carry extra "stuff."
- Quickly and securely mounts to handlebars, frame, fork or most anywhere.

1-CS-STUFF-V104



ENERGY CADDY XL 76g

- 0.8 L Capacity.
- Large, simple top tube organizer for quick access to snacks and smaller items.
- Water resistant, zippered main compartment with side sleeves.
- Large enough for a phone.
- Durable, high quality materials.
- Reflective features for added safety.

1-EC-XLCADDY-V104



SMART ENERGY CADDY 81g

- 0.4 L Capacity.
- Lightweight, semi-rigid top tube mounted phone holder.
- Molded EVA foam structure with woven nylon cover.
- Compact design with extra wide clamshell opening.
- Mesh divider keeps additional items in place.
- Clear, touchscreen compatible cover.
- Three Velcro strap design attaches securely to the top tube.

1-EC-SMART-V104



CADDY SACK

S: 30g M: 50g

- Simple, reusable sack holds a variety of ride essentials.
- Durable materials, welded seams and roll top closure provide weather protection.
- Large opening offers quick, easy access.
- Available in Small and Medium sizes.

S: 1-CS-CADDY-V2S04, M: 1-CS-CADDY-V2M04



CADDY KIT 193g.

- Caddy Sack
- Twin Speed Drive CO2 head.
- Two 16g CO2 cartridges.
- Smart Kit glueless patch kit.
- Power Levers.

1-C2-CADDYKIT-V1S04



ENERGY CADDY 87g

- 0.5 L Capacity
- Large, simple top tube organizer for quick access to snacks and smaller items.
- Molded EVA foam structure with durable nylon cover.
- Elastic midsection expands to accommodate larger content.
- Velco-mesh cover keeps items in place.

1-EC-ENERGY-V2L04



NEW FLOW TOOL CADDY PRO 79g.

- Sleek, water bottle shaped organizer fits into standard bottle cages.
- Internal compartments organize cycling essentials.
- Soft, semi-rigid shell is durable and water resistant.
- Full zipper allows for 180° opening.
- Tools not included.

1-BC-FLWCA-V304



FLOW CADDY 193g.

- Lightweight, rigid container that fits in standard bottle cages.
- Universal storage for essential roadside repair goods.
- Water resistant threaded lid.
- Available with or without organizer sleeve.

Caddy only: 1-BC-FLWCADDY-V104
Caddy with Organizer: 1-BC-FLWCADDY-V204



CHAINSTAY PROTECTOR

S: 95 x 250 mm M: 130 x 250 mm L: 180 x 250 mm

- Durable protector designed to reduce chain noise.
- Puncture resistant exterior neoprene protects frame finish.
- Rubberized interior prevents slippage.
- Available in three sizes.
- Machine washable.

S: 1-PR-SMART-V1S, M: 1-PR-SMART-V1M, L: 1-PR-SMART-V1L



GENERAL INQUIRIES

Email: info@lezyne.com

USA HQ: +1.805.548.8780

INTERNATIONAL SALES

Email: sales@lezyne.com

USA SALES

Email: usa-sales@lezyne.com

WARRANTY

Email: warranty@lezyne.com

MARKETING

Email: marketing@lezyne.com

USA HEADQUARTERS

Lezyne USA, Inc.

645 Tank Farm Road, Unit F.

San Luis Obispo, CA 93401

United States of America

TAIWAN FACTORY

Lezyne USA, Inc. Taiwan Branch

No. 162 Shigu Ln. Guozhong Rd.

Dali District, Taichung City 421

Taiwan R.O.C.

2019-2020 © LEZYNE USA, INC

All rights reserved. Lezyne is a trademark of Lezyne USA, Inc. and is registered both in the United States and internationally.

Lezyne holds the rights to all of the material within this catalog. Any unauthorized use is expressly prohibited and will be prosecuted to the fullest extent of the law.

Photos: Sebas Romero

