



# Industrial Index

---

**CLICK ON THE SECTION THAT INTERESTS YOU**

**CLIQUEZ SUR LA SECTION QUI VOUS INTÉRESSE**

---

**PRICES UPDATED ANNUALLY SEPTEMBER 1** – AND EXTRA UPDATES AS NEEDED

**BOOKING PROGRAMS AVAILABLE SEPTEMBER 1** - FOR TIRE CHAIN AND TOYS

SECTION **1:** Chain - Gr.30, Gr.40, Gr.70, Gr.80 Zinc Chain

---

SECTION **2:** Chain Assemblies & Components for Gr.30, Gr.40, Gr.70  
Load Binders - Safety Chain - Logging Chokers  
Shackles - Connecting Links - Clevis Links - Hooks - Eye Bolts...

---

SECTION **3-a** Overhead Lifting Booklet:  
Gr. 80 - Gr. 100 Chain Sling Components, Links, Hooks, Rings  
*\* Basic Sling Building Information (Call for prices)*

SECTION **3-b** Magnet Lifters - Lifting Clamps – Drum Lifters

---

SECTION **4:** Hand Hoist  
Snatch Blocks

---

SECTION **5:** Wire Rope & Aircraft Cable - Wire Rope Slings  
Clips – Thimbles – Snap Links - Turn Buckles  
Swaging Tools

---

SECTION **6:** Nylon Slings  
Round Slings  
Wire Mesh Slings

---

SECTION **7:** Cargo Control Booklet and Price List

SECTION **7-b** Hooks and components Display Packaged

SECTION **7-c** Tire Chain Price List

---

SECTION **8:** Hitch Pins & Accessories

---



**PROOF COIL CHAIN - REGULAR LINK****GRADE 30 - BRIGHT ZINC - Pails**

ITEM #	CHAIN SIZE	WIRE DIA.	FT. PER PAIL	WT. PER PAIL LBS.
600029	3/16"	.188	400	116
600030	1/4"	.250	200	104
600031	5/16"	.312	138	119
600080	3/8"	.375	100	125

**GRADE 40 - SELF COLOUR****COIL CHAIN - HIGH TEST**

ITEM #	CHAIN SIZE	WIRE DIA.	INSIDE LENGTH	OUTSIDE WIDTH	DRUM QTY.	1/2 DRUM	W.L.L. LBS.	WT./FT. LBS.
600050	1/4"	.276	1"	.41"	800	400	2600	.75
600051	5/16"	.343	1.1"	.48"	550	275	3900	1.04
600049	3/8"	.394	1.16"	.57"	400	200	5400	1.45
600053	1/2"	.531	1.56"	.78"	200	100	9200	2.70

All prices subject to change without notice.

Manufacturer's link dimensions may vary.

**PROOF COIL CHAIN - REGULAR LINK****A REGULAR UTILITY CHAIN**

SUITABLE FOR USE AS TOW CHAINS &amp; ANCHOR CHAINS.

**GRADE 30 - SELF COLOUR**

ITEM #	CHAIN SIZE	WIRE DIA.	INSIDE LENGTH	INSIDE WIDTH	DRUM QTY.	1/2 D QTY.	WLL LBS.	WT. PER FT./LBS.
600001	1/8"	.13	.69	.25	250	125	325	.20
600125	3/16"	.188	.98"	.41"	1600	800	600	.27
600127	1/4"	.250	1.05"	.49"	900	450	1050	.53
600008	5/16"	.312	1.19"	.49"	600	300	1700	.86
600010	3/8"	.375	1.29"	.61"	400	200	2400	1.21
600013	1/2"	.492	2.05"	.88"	250	125	4150	2.23

**GRADE 30 - HOT GALVANIZED**

ITEM #	CHAIN SIZE	WIRE DIA.	INSIDE LENGTH	INSIDE WIDTH	DRUM QTY.	1/2 QTY.	WLL LBS.	WT. PER FT./LBS.
599998	3/16"	.188	.98"	.41"	1600	800	600	.27
600018	1/4"	.250	1.05"	.49"	900	450	1050	.53
600017	5/16"	.312	1.19"	.49"	600	300	1700	.86
600012	3/8"	.375	1.29"	.61"	400	200	2400	1.21
600019	1/2"	.492	2.05"	.88"	250	125	4150	2.23

**GRADE 30 - BRIGHT ZINC**

ITEM #	CHAIN SIZE	WIRE DIA.	INSIDE LENGTH	INSIDE WIDTH	DRUM QTY.	1/2 QTY.	WLL LBS.	WT. PER FT./LBS.	Apr.12/21 PER'
599997									
600126	3/16"	.188	.98"	.41"	1600	800	600	.27	
600128	1/4"	.250	1.05"	.49"	900	450	1050	.53	
600130	5/16"	.312	1.19"	.49"	600	300	1700	.86	
600132	3/8"	.375	1.29"	.61"	400	200	2400	1.21	
600041	1/2"	5.0			250	125		2.24	

**GRADE 30 - SELF-COLOUR - PAILS**

ITEM #	CHAIN SIZE	WIRE DIA.	FT. PER PAIL	WT. PER PAIL LBS.
600025	3/16"	.188	400	116
600026	1/4"	.250	200	104
600027	5/16"	.312	138	119
600028	3/8"	.375	100	125



**GRADE 70 IS A HIGH STRENGTH LIGHT WEIGHT CHAIN, DESIGNED FOR THE TRUCKING AND LOGGING INDUSTRY.**  
*Chain is embossed "Gr.7"*

**GRADE 70 - YELLOW DICHROMATE - DRUMS**

ITEM #	CHAIN SIZE	WIRE DIA.	INSIDE LENGTH	INSIDE WIDTH	DRUM QTY.	WLL LBS.	WT.PER FT.LBS.
601027	1/4"	.281	.85"	.41"	800	3150	.75
601028	5/16"	.343	.92"	.47"	550	4700	1.13
601029	3/8"	.394	1.15"	.57"	400	6600	1.52
601030	1/2"	.519	1.50"	.80"	200	11300	2.40
601032	5/8						

**GRADE 70 - PAILS**

ITEM #	CHAIN SIZE	WIRE DIA.	FEET PER PAIL	WT. PER PAIL/LBS.
601006	1/4"	.281	150	113
601009	5/16"	.343	135	153
601011	3/8"	.395	100	152
601014	1/2"	.500	50	120



**GRADE 80 IS SUITABLE FOR OVERHEAD LIFTING**

**GRADE 80 - ALLOY CHAIN**

ITEM #	CHAIN SIZE IN.	MM	INSIDE LENGTH	INSIDE WIDTH	LINKS PER FT.	WT.PER 100'/LBS.	WLL LBS.
602005	7/32	5.6				42	2,100
602030	9/32	7	.870	.395	14	71	3,500
602032	3/8	10	1.223	.575	10	144	7,100
602033	1/2	13	1.401	.720	7-3/4	236	12,000
602034	5/8	16	1.734	.853	6-1/4	380	18,000
602035	3/4	20	2.040	.960	6	556	28,300
602022	7/8	22	2.250	1.130	5-1/3	735	34,200
602027	1	25	2.663	1.350	4-1/2	975	47,700
602028	1-1/4	32	3.250	1.656	3-3/4	1522	72,300

## CHAIN REELS & BULK CHAIN

### TWIN LOOP CHAIN



SIZE	ITEM #	WIRE DIA.	FINISH	WEIGHT PER / FT.	REEL LENGTH
No. 4	600276		Zinc		250'
No. 3	600275	.080	Zinc	.45 lbs.	150'
No. 2/0	605035	.135	Zinc	.12 lbs.	125'
No. 1/0	605036	.120	Zinc	.14 lbs.	100'
No. 3/0	605040		Zinc		100'

### TWIN LOOP CHAIN - BULK



No. 3	600274	.080	Zinc	.45 lbs.	
No. 2/0	605039	.135	Zinc	.12 lbs.	
No. 1/0	605038	.120	Zinc	.14 lbs.	

### MACHINE TWIST LINK



No. 4	605003	.125	Zinc	.14 lbs.	100'
No. 3	600003	.136	Zinc		100'
No. 2/0	600002		Zinc	.32 lbs.	75'

### MACHINE STRAIGHT LINK



No. 2	600101		Zinc		125'
-------	--------	--	------	--	------

### STEEL SASH CHAIN



No. 8	605010		Zinc	.045 lbs.	100
No.35	605011		Zinc	.08 lbs.	100'
No. 45	605012		Zinc	.11 lbs.	100

### SINGLE JACK CHAIN



No. 8	605053		Zinc	.21 lbs.	100'
No. 10	605050		Zinc		100'
No. 12	605054		Zinc	.10 lbs.	100'
No. 16	605057		Zinc		100'

### PASSING LINK CHAIN



No. 2/0	605120		Zinc	.31 lbs.	100'
---------	--------	--	------	----------	------

### PASSING LINK CHAIN - BULK



No. 5/0	605150		Zinc		
---------	--------	--	------	--	--

### COIL CHAIN STRAIGHT LINK - BULK



ITEM #	WIRE DIA.	LINK LENGTH	FINISH	FT./ BOX	WEIGHT/ BOX
501039	4mm	25mm	Zinc	100	3.85 lbs.
501038	4mm	30mm	Zinc	100	3.70 lbs.
599999	3/16		Zinc	100	5.40 lbs.

### COIL CHAIN TWIST LINK - BULK



ITEM #	WIRE DIA.	FINISH	FT./ BOX	WEIGHT/ BOX
500039	4mm	Zinc	100	4.0 lbs.
500055	5.5mm	Zinc	100	7.9 lbs.

**CHAIN ASSEMBLIES**



ITEM #	G-7 TIE DOWN CHAIN - 3150 LBS. RATED W.L.L.
601068	1/4 Gr. 70 x 12' c/w Grab Hook each end
601069	1/4 Gr. 70 x 16' c/w Grab Hook each end
601070	1/4 Gr. 70 x 20' c/w Grab Hook each end

ITEM #	G-7 TIE DOWN CHAIN - 4700 LBS. RATED W.L.L.
601087	5/16 Gr. 70 x 12' c/w Grab Hook each end
601088	5/16 Gr. 70 x 16' c/w Grab Hook each end
601089	5/16 Gr. 70 x 20' c/w Grab Hook each end
601090	5/16 Gr. 70 x 25' c/w Grab Hook each end

ITEM #	G-7 TIE DOWN CHAIN - 6600 LBS. RATED W.L.L.
601112	3/8 Gr. 70 x 12' c/w Grab Hook each end
601105	3/8 Gr. 70 x 16' c/w Grab Hook each end
601114	3/8 Gr. 70 x 20' c/w Grab Hook each end
601113	3/8 Gr. 70 x 25' c/w Grab Hook each end

**LOAD BINDERS**

ITEM #	DESCRIPTION
604128	Standard Load Binder 1/4 5/16 Gr.70
604132	Standard Load Binder 5/16 3/8 Gr.70
604140	Standard Load Binder 3/8 1/2 Gr.70

ITEM #	DESCRIPTION
604160	Safety Load Binder 5/16 3/8 Gr.70

ITEM #	DESCRIPTION
604161	Ratchet Type 5/16 3/8 Gr. 70
604162	Ratchet Type 3/8 1/2 Gr. 70
604163	Ratchet Type 1/2 5/8 Gr. 70

All prices subject to change without notice.

ITEM #	DESCRIPTION
649635	Yellow Binder Lock

A simple effective way of keeping your binder secure.

PRICES SUBJECT TO CHANGE WITHOUT NOTICE



**STANDARD LOAD BINDER**

**SAFETY LOAD BINDER**

**RATCHET TYPE LOAD BINDER**



## SAFETY CHAINS



*SAFETY CHAIN meets ASAE specification and MTO regulation 618 section 5, subsection 1 & 2*  
 Latch type SLIP HOOKS ensure a secure hook up.  
 Each assembly comes with identification tag.

ITEM #	DESCRIPTION	RATING/lb.
604420	1/4 G-7 x 5' c/w 2 1/4 G-7 Clevis Slip Hook w/Latch Per Foot Adder	10,000
604440	5/16 G-7 x 5' c/w 2 5/16 G-7 Clevis Slip Hooks w/Latch Per Foot Adder	15,000
604460	3/8 G-7 x 5' c/w 2 3/8 G-7 Clevis Slip Hooks w/Latch Per Foot Adder	20,000



ITEM #	SAFETY CHAIN ASSEMBLY with SLIP HOOK	RATING/lb.
604429	1/4" Gr. 70 - 5' reach	10,000
604449	5/16" Gr. 70 - 5' reach	15,000
604469	3/8" Gr. 70 - 5' reach	20,000
604479	1/2" Gr. 70 - 5' reach	33,100



*SAFETY CHAIN meets ASAE specification and MTO 489 regulations.*  
 Latch type Grab Hook ensures a secure hook up.  
 Each assembly comes with identification tag.  
 Finish is bright zinc plated.

ITEM #	SAFETY CHAIN ASSEMBLY with SAFETY GRAB HOOK	RATING/lb.
651027	1/4" Gr. 70 - 5' reach	10,000
651030	5/16" Gr. 70 - 5' reach	15,000
651028	3/8" Gr. 70 - 5' reach	20,000
651029	1/2" Gr. 70 - 5' reach	33,100

All prices subject to change without notice.

## SAFETY CHAIN Gr. 30

ITEM #	SAFETY CHAIN ASSEMBLY
604431	1/4" X 34" w/S Hook and Safety Latch



**CLEVIS LINK - GR 70**

APRIL 23/21

ITEM #	SIZE	WEIGHT/LB.
604071	1/4 - 5/16	1.2
604072	3/8	1.6
604073	1/2"	1.9

**CLEVIS SLIP HOOK - WITH LATCH - GR.70**

ITEM #	CHAIN SIZE	WEIGHT/LB.
604060	1/4"	.60
604062	5/16"	.81
604064	3/8"	1.32
604066	1/2"	1.5
604012	5/5"	

**LATCH ASSEMBLIES - FOR SLIP HOOK**

ITEM #	CHAIN SIZE	WEIGHT/LB.
604061	1/4	.1
604063	5/16	.1
604065	3/8	.1
604067	1/2	.1

**GRAB HOOK - LATCH TYPE - GR 70**

ITEM #	LATCH TYPE	GRAB HOOK	RATED/LB.
698024	1/4"	Gr. 70 hook w/latch	10,000
698022	5/16"	Gr. 70 hook w/latch	15,000
698025	3/8"	Gr. 70 hook w/latch	20,000
698026	1/2"	Gr. 70 hook w/latch	33,000

**CLEVIS GRAB HOOKS - GRADE 70**

ITEM #	CHAIN	W.L.L.	WEIGHT/LB.		DIMENSIONS/INCHES				
	SIZE		LB.	PER/100	A	B	C	D	E
604101	1/4								
604168	5/16	4,700	85	3-7/16	2-17/32	29/32	3/8	7/16	
604110	3/8	6,600	138	3-15/16	2-15/64	1	1/2	1/2	
604114	1/2	11,300	300	5-1/8	7-7/32	1-5/8	5/8	5/8	

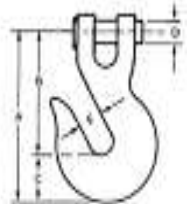
**DO NOT USE FOR OVERHEAD LIFTING** HEAT TREATED. Use with Grade 70 & Grade 40.**CLEVIS SLIP HOOK - GRADE 70**

ITEM #	CHAIN SIZE
604099	1/4"
604169	5/16"
604106	3/8"
604118	1/2"

**DOUBLE CLEVIS LINK - GR 70 - ZINC PLATED**

ITEM #	CHAIN SIZE	OVERSIZED END	W.L.L./ LB.	WT./LB PER 100
604305	1/4 - 5/16	.492"	4,700	44.0
604308	5/16 - 3/8	.635"	6,600	87.5
604309	1/2	.771	11,300	184

**MID LINK - DOUBLE CLEVIS - GR 70 - ZINC PLATED**

ITEM #	LINK SIZE	W.L.L./ LB.	WT./LB PER 100
604306	1/4-5/16	4,700	33
604310	3/8	6,600	45
604311	1/2	11,300	100
604316	5/8		

**Do not exceed Working Load Limits**

PRICES SUBJECT TO CHANGE WITHOUT NOTICE



SEPTEMBER 1, 2020

**CLEVIS SLIP HOOK - CARBON STEEL - GRADE 40**

ITEM #	CHAIN		DIMENSIONS/INCHES								WEIGHT/LB. /100	LIST
	SIZE	A	B	C	D	E	F	H	K			
604100	1/4	13/16	11/32	11/32	2-5/8	15/32	7/8	27/32	17/32	50		
604167	5/16	7/8	13/32	13/32	3	1-3/32	1-1/6	15/16	19/32	80		
604109	3/8	1	15/32	15/32	3-1/2	1-1/4	1-1/4	1-1/8	21/32	130		
604113	1/2	13/16	5/8	5/8	4-5/8	1-3/4	1-5/8	1-21/32	7/8	275		

For use with Grade 30, 40, &amp; 50 chain.

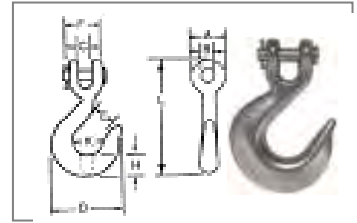
**CLEVIS GRAB HOOK - CARBON STEEL - GRADE 40**

ITEM #	CHAIN		DIMENSIONS/INCHES					WT./LB. /100
	SIZE	A	B	C	D	E	L	
604102	1/4"	13/16	11/32	11/32	1-7/8	3/8	3-3/8	43
604103	5/16	1-1/16	13/32	13/32	2-1/4	9/16	3-29/32	76
604115	3/8	1-1/4	15/32	15/32	2-5/8	1/2	4-1/4	121
604116	1/2	1-5/8	16/32	5/8	3-1/4	21/32	5-9/16	220

For use with Grade 30, 40 &amp; 50 chain

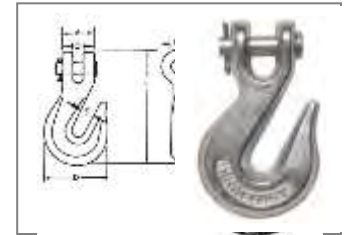
**EYE GRAB HOOKS - CARBON STEEL**

ITEM #	CHAIN	W.L.L. LBS.	WEIGHT/LB.
	SIZE		
604097	1/4	2,600	.28
604105	5/16	3,900	.45
604108	3/8	5,400	.79

**EYE SLIP HOOKS - CARBON STEEL**

ITEM #	CHAIN	W.L.L. LBS.	WEIGHT/LB.
	SIZE		
604098	1/4	1,950	.40
604104	5/16	2,875	.70
604107	3/8	4,000	.90
604117	1/2	6,500	2.75

**LATCH KITS - STAINLESS**

ITEM #	AWL TONS	WEIGHT/LB.
604023	3/4 - 1	.02
604032	1-1/2 - 2	.03
604036	3	.06
604038	5	.11
604040	7-1/2	.14





**LOGGING CHOKERS**

ITEM #	LOGGING CHOKER
605321	5/16 x 60" Chain Choker with Hook & Rod
605322	5/16 x 72" Chain Choker with Hook & Rod
605304	5/16 x 90" Chain Choker with Hook & Rod
605497	1/4 x 60" Chain Choker with Hook & Rod
605498	1/4 x 72" Chain Choker with Hook & Rod
605499	1/4 x 90" Chain Choker with Hook & Rod
604090	Choker Hook only

**FERRULE LOGGING CHOKERS**

DIAMETER	W.L.L./ TONS
1/2" IWRC SWL	13.3
9/16" IWRC SWL	16.8
5/8" IWRC SWL	20.6

Call for Pricing

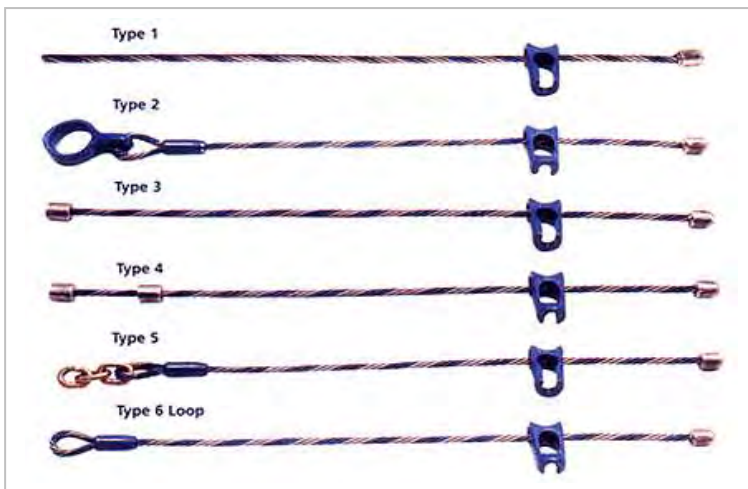

ITEM #	DESCRIPTION
605318	Main Line Hook (Twitch Hook)

605354	Roll Pin for Hook 5/16 x 2"
--------	-----------------------------

ITEM #	DESCRIPTIN
605310	Logging Choker 3/8 - 1/2



**LAP LINK REPAIR CONNECTORS**

ITEM #	LINK SIZE	W.L.L./ LB.	WT. /LB. PER 100
503704	3/16x1	200	4
503706	1/4 x1-1/4	300	8
503708	5/16x1-1/2	500	14
503710	3/8 x1-5/8	825	25
503713	1/2		

**QUICK LINKS - ZINC PLATED**

ITEM #	LINK SIZE	W.L.L./ LB.	WT. /LB. PER 100
503402	1/8	220	3
503404	3/16	610	5
503406	1/4	880	7
503408	5/16	1,540	16
503410	3/8	1,980	22
503411	1/2	3,300	51

**COLD SHUTS - ZINC PLATED**

ITEM #	LINK SIZE	W.L.L./ LB.	WT./LB. PER 100
503604	3/16	340	3
503606	1/4	750	6
503608	5/16	1,250	10
503610	3/8	1,900	10
503611	7/16	2,650	27
503613	1/2	4,090	38



Use next size larger Cold Shut than diameter of Grade 30 chain.

**SNAP LINK - ZINC PLATED - BULK**

ITEM	SIZE	WT/LB. PER 100
605172	3/16" Snap Link	5
605173	1/4" Snap Link	6
605174	5/16" Snap Link	15
605178	3/8" Snap Link	20
605177	7/16" Snap Link	
605181	1/2" Snap Link	60

**S-LINK - ZINC - FOR LIGHT DUTY SAFETY CHAIN**

ITEM #	SIZE	DESCRIPTION
604261	3/8"	Twisted
503217	3/8"	Straight

**S-LINK - WITH LATCH**

ITEM #	SIZE	DESCRIPTION
502993	9.5	for 3/16 chain
502994	11.6	for 1/4" chain



**ANCHOR SHACKLES - SCREW PIN TYPE**

APRIL 23/21

ITEM#	D	P	W	L	B	OUTSIDE WT/		
SCREW PIN	WLL TONS	SIZE DIA.	DIA. /PIN	BETWN EYES	INSIDE LENGTH	INSIDE BOW W.	DIA. OF EYE	100 LBS.
604164	1/3	3/16	1/4	3/8	7/8	5/8	17/32	6
604208	1/2	1/4	5/16	15/32	1-1/8	13/16	11/16	12
604214	3/4	5/16	3/8	17/32	1-1/4	7/8	13/16	20
604210	1	3/8	7/16	21/32	1-7/16	1-1/16	31/32	30
604211	1-1/2	7/16	1/2	23/32	1-11/16	1-1/4	1-1/8	50
604213	2	1/2	5/8	13/16	1-15/16	1-7/16	1-1/4	75
604216	3-1/4	5/8	3/4	1-1/16	2-1/2	1-3/4	1-9/16	130
604219	5	3/4	7/8	1-1/4	3	2	1-7/8	225
604220	6-1/2	7/8	1	1-7/16	3-1/4	2-5/16	2-1/8	350
604221	8-1/2	1	1-1/8	1-11/16	3-3/4	2-9/16	2-3/8	500
604222	9-1/2	1-1/8	1-1/4	1-13/16	4-1/4	2-15/16	2-5/8	700
604224	12	1-1/4	1-3/8	2	4-1/2	3-1/4	3-1/16	950
604225	14	1-3/8	1-1/2	1-1/4	5-1/4	3-1/2	3-1/4	1250
604226	17	1-1/2	1-5/8	2-3/8	5-3/4	3-3/4	3-1/2	1750
604223	25	1-3/4	2	2-7/8	7	5	4	2770
604238	35	2	2-1/4	3-1/4	7-3/4	5-3/4	4-1/2	3900
ROUND PIN	D	P	W	L	B	OUTSIDE WT/		
604204	1/2	1/4	5/16	15/32	1-1/8	13/16	11/16	12
604245	1	3/8	7/16	21/32	1-7/16	1-1/16	31/32	30
604239	2	1/2	5/8	13/16	1-15/16	1-7/16	1-1/4	75
604217	3-1/4	5/8	3/4	1-1/16	2-1/2	1-3/4	1-9/16	130
604237	5	3/4	7/8	1-1/4	3	2	1-7/8	225
604247	6-1/2	7/8	1	1-7/16	3-1/4	2-5/16	2-1/8	350

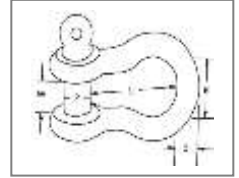
**ANCHOR  
Screw Pin Shackle****CHAIN SHACKLES - SCREW PIN TYPE**

ITEM #	D	P	W	L	B	OUTSIDE	WT/	PRICE
SCREW PIN	WLL TONS	SIZE DIA.	DIA. OF PIN	BETWN EYES	INSIDE LENGTH	DIA. OF EYE	100 LB.	SCREW
604209	1/2	1/4	5/16	15/32	7/8	11/16	11	
	3/4	5/16	3/8	17/32	1	13/16	17	
	1	3/8	7/16	21/32	1-1/4	31/32	29	
	1-1/2	7/16	1/2	23/32	1-1/2	1-1/8	40	
604212	2	1/2	5/8	13/16	1-11/16	1-1/4	60	
604215	3-1/4	5/8	3/4	1-1/16	2	1-9/16	125	
	4-3/4	3/4	7/8	1-1/4	2-5/16	1-7/8	200	
	6-1/2	7/8	1	1-7/16	2-7/8	2-1/8	300	
	8-1/2	1	1-1/8	1-11/16	3-1/4	2-3/8	450	
	9-1/2	1-1/8	1-1/4	1-13/16	3-1/2	2-5/8	650	
	12	1-1/4	1-3/8	2	3-11/16	3-1/4	860	
604235	13-1/2	1-3/8	1-1/2	2-1/4	4-1/2	3-1/16	1200	
	17	1-1/2	1-5/8	3-3/8	5	3-1/4	1500	
	24	1-5/8	1-3/4	2-5/8	5-1/4	3-7/8	2200	
	25	1-3/4	2	2-7/8	5-7/8	4	2700	
	35	2	2-1/4	3-1/4	6-3/4	4-1/2	3600	
ROUND PIN	D	P	W	L	B	OUTSIDE		
604241	3/4	5/16	3/8	17/32	1	13/16	17	
604242	1	3/8	7/16	21/32	1-1/4	31/32	29	
604229	2	1/2	5/8	13/16	1-11/16	1-1/4	60	
604230	3-1/4	5/8	3/4	1-1/16	2	1-9/16	125	
604243	6-1/2	7/8	1	1-7/16	2-7/8	2-1/8	300	

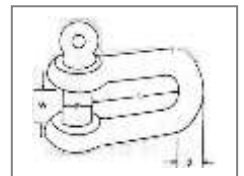
**CHAIN  
Screw Pin D Shackle****ANCHOR SHACKLES - WITH BOLT, NUT AND COTTER PIN**

ITEM #	D	P	W	B	L	WT. /LB.	OUTSIDE
	WLL TONS	SIZE DIA.	BOLT DIA.	BETWN EYES	INSIDE BOW W.	INSIDE LENGTH	DIA. OF EYE
604227	2	1/2	5/8	13/16	1-7/16	1-15/16	1-1/4
604246	3-1/4	5/8	3/4	1-1/16	1-3/4	2-1/2	1-9/16
604233	5	3/4	7/8	1-1/4	2	3	1-7/8
604244	8-1/2	1	1-1/8	1-11/16	2-9/16	3-3/4	2-3/8
604249	9-1/2	1-1/8	1-1/4	1-13/16	2-15/16	4-1/4	2-5/8
604236	12	1-1/4	1-3/8	2	3-1/4	4-1/2	3-1/16

Do not exceed the working load limit.

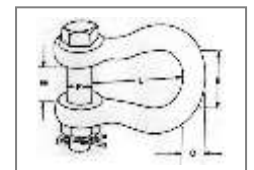

**SHOULDER EYE BOLTS - SELF COLOUR**

SEPTEMBER 1, 2020

SIZE	ITEM #	W.L.L.		DIMENSIONS IN INCHES								LIST
		LB.	WT/100.	A	B	C	E	F	G	H		
1/4 x 2	606066	650	6.6	.25	.50	.88	1.5	2.0	2.94	.5		
1/4 x 4	606067	650	9.1	.25	.50	.88	2.5	4.0	4.94	.5		
5/16x2-1/4	606008	1200	12.5	.31	.62	1.12	1.5	2.25	3.5	.69		
5/16x4-1/4	606030	1200	18.8	.31	.62	1.12	2.5	4.25	5.5	.69		
3/8 x 2-1/2	606029	1550	21.4	.38	.75	1.38	1.5	2.5	3.97	.78		
3/8 x 4-1/2	606065	1550	25.3	.38	.75	1.38	2.5	4.5	5.97	.78		
1/2 x 3-1/4	606060	2600	42.6	.50	1.0	1.75	1.5	3.25	5.12	1.0		
1/2 x 6	606014	2600	56.8	.50	1.0	1.75	3.0	6.0	7.88	1.0		
5/8 x 4	606061	5200	68.6	.62	1.25	2.25	2.0	4.0	6.44	1.31		
5/8 x 6	606015	5200	102.4	.62	1.25	2.25	3.0	6.0	8.44	1.31		
3/4 x 4-1/2	606062	7200	144.5	.75	1.5	2.75	2.0	4.5	7.44	1.56		
3/4 x 6	606020	7200	167.5	.75	1.5	2.75	3.0	6.0	8.94	1.56		
7/8 x 5	606034	10600	225	.88	1.75	3.25	2.5	5.0	8.46	1.84		
1 x 6	606027	13300	366.3	1.0	2.0	3.75	3.0	6.0	9.97	2.09		
1-1/4 x 8	606011	21000	650	1.25	2.5	4.5	4.0	8.0	12.72	2.47		

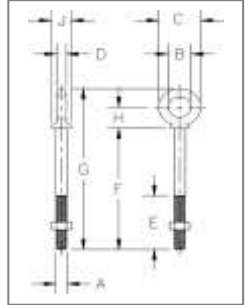
**Working Load Limit applies to straight pull only.****CAUTION:****Do not exceed Working Load Limits.****Never insert only the point of a hook onto an eye bolt****Always use a shackle.****MACHINED EYE BOLTS - SHOULDER TYPE- SELF COLOUR**

SIZE	ITEM #	W.L.L.		DIMENSIONS IN INCHES							
		LB.	WT/100.	A	B	C	E	F	G	H	
1/4x1	606049	650	3.20	.25	1.00	.88	1.94	.19	.47	.50	
5/16 x 1-1/8	606064	1200	8.5								
3/8x1-1/4	606050	1550	12.50	.38	1.25	1.38	2.72	.31	.66	.78	
1/2x1-1/2	606013	2600	25.00	.50	1.50	1.75	3.38	.38	.91	1.00	
5/8x1-3/4	606052	5200	50.00	.63	1.75	2.25	4.19	.50	1.12	1.31	
3/4x2	606019	7200	87.50	.75	2.00	2.75	4.94	.62	1.38	1.56	
7/8x2-1/4	606021	10600	129.0								
1x2-1/2	606022	13300	218.00	1.00	2.50	3.75	6.47	.88	1.81	2.09	
1-1/4x3	606024	21000	380.00	1.25	3.00	4.50	7.72	1.00	2.28	2.49	
1-1/2x3-1/2	606025	24000	654.0								

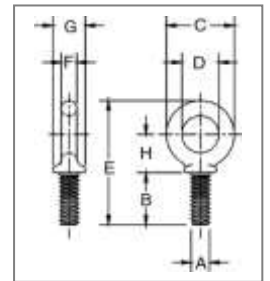
**Ultimate Load** is 5 times the Working Load Limit.

ZINC AVAILABLE

# TRYGGLOCK

**Overhead Lifting Components**  
*Safety and Service Come First*

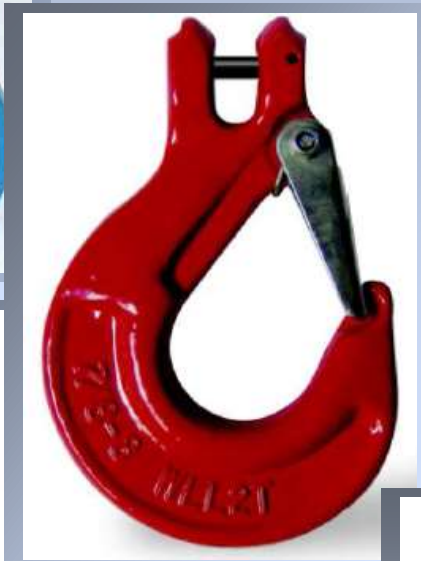
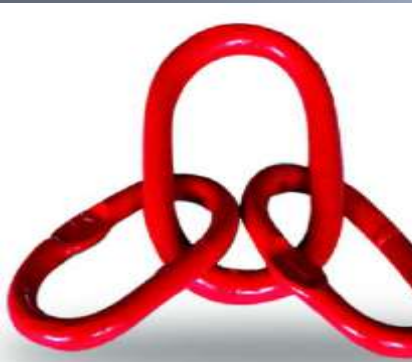

ALL COMPONENTS ARE RED

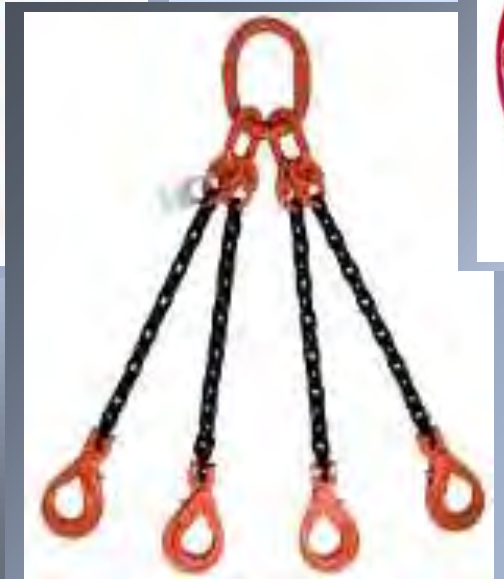
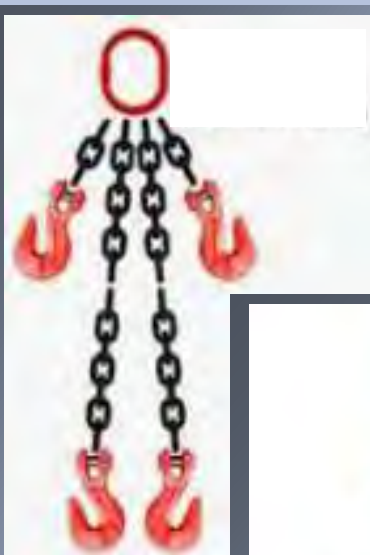

# INDEX

***GRADE 80***

<u>Cover</u>	<u>page 1</u>
<u>Index</u>	<u>page 2</u>
<u>Master Links</u>	<u>page 3</u>
<u>Master Link Assembly</u>	<u>page 3</u>
<u>Connecting Links</u>	<u>page 3</u>
<u>Sling Connecting Link</u>	<u>page 3</u>
<u>Clevis Pear Link</u>	<u>page 3</u>
<u>Clevis Sling Hook w/latch</u>	<u>page 4</u>
<u>Eye Sling Hook w/latch</u>	<u>page 4</u>
<u>Swivel Hook w/latch</u>	<u>page 4</u>
<u>Cast Latch Kit</u>	<u>page 4</u>
<u>Clevis Cradle Grab Hook</u>	<u>page 4</u>
<u>Clevis Grab Hook</u>	<u>page 4</u>
<u>Eye Cradle Grab Hook</u>	<u>page 4</u>
<u>Clevis Self Locking Hook</u>	<u>page 5</u>
<u>Eye Self Locking Hook</u>	<u>page 5</u>
<u>Swivel Self Locking Hook</u>	<u>page 5</u>
<u>Trigger Parts</u>	<u>page 5</u>
<u>Weld-On Hook</u>	<u>page 5</u>
<u>Sliding Eye Choker Hook</u>	<u>page 5</u>
<u>Eye Foundry Hook</u>	<u>page 5</u>
<u>Warnings and Load Limits</u>	<u>page 6-7</u>
<b><i>GRADE 100</i></b> <u>Links Hooks and Connector</u>	<u>page 8</u>
<u>How to Order a Chain Sling</u>	<u>page 9-12</u>

# GRADE 80

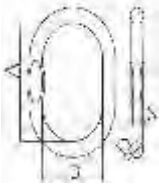

### SLR33 MASTER LINK with Flat Design Factor 4:1

ITEM #	SIZE mm	WT./kg.	W.L.L./lb.	A/mm	B/mm	D/mm
618306	7-8	Red	0.54	4500	110	60
618307	10-8	Red	0.823	7100	135	75
618308	13-10	Red	1.5	12000	160	90
618310	16-13	Red	2.32	17500	180	100
618313	18-16	Red	3.95	24500	200	110
618317	20-18	Red	6.34	31000	260	140
618318	22-20	Red	8.96	37500	300	160

Do Not Exceed Working Load Limit



### SLR487 MASTER LINK with Flat Design Factor 4:1

ITEM #	SIZE mm	WT./kg.	W.L.L./lb.	A/mm	B/mm	D/mm
618305	10-08	Red	0.67	7700	140	80
618311	13-10	Red	1.2	12300	160	95
618309	16-13	Red	2.45	20800	190	110
618319	22-20	Red	7.50	49100	275	150

Do Not Exceed Working Load Limit

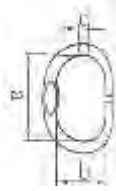

### SLR032 MASTER LINK ASSEMBLY with Flat Design Factor 4:1

ITEM #	SIZE mm	WT.kg.	W.L.L./lb.	A/mm	B/mm	D/mm	a	b	d	S
618407	6	032 Red	1.18	5200	135	75	18	54	25	13
618408	7	032 Red	1.24	7000	135	75	18	60	38	13
618410	8	032 Red	2.2	9300	160	90	22	70	34	16
616411	10	032 Red	3.4	14,500	180	100	26	85	40	18
618413	13	032 Red	6.1	24500	200	110	32	115	50	22
618416	16	032 Red	9.98	37500	260	140	36	140	65	26
618421	18	032 Red	18.9	47000	340	180	45	180	100	32
618422	20	032 Red	22.6	58500	350	190	50	180	100	32
618423	22	032 Red	25.2	69500	350	190	50	180	100	36

Do Not Exceed Working Load Limit

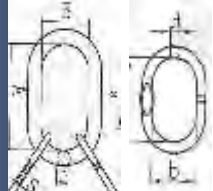

### SLR488 MASTER LINK ASSEMBLY with Flat Design Factor 4:1

ITEM #	SIZE mm	WT.kg.	W.L.L./lb.	A/mm	B/mm	D/mm	a	b	d	S
618424	20	Red	21.78	73800	340	180	45	230	130	32

Do Not Exceed Working Load Limit

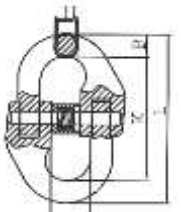

### SLR074 CONNECTING LINK Design Factor 4:1

ITEM #	SIZE mm	WT./kg.	W.L.L./lb.	A/mm	L/mm	K/mm	Hmm
618006	6	074 Red	0.8	2100	15	58	42
618007	7-8	074 Red	0.146	4500	18	79.5	62.5
618010	10	074 Red	0.30	7100	25	93	68
618013	13	074 Red	0.70	12000	29	117	87
618016	16	074 Red	1.1	18100	34.5	148	108.4
618018	20	074 Red	1.8	28300	41	169.5	121.5

Do Not Exceed Working Load Limit

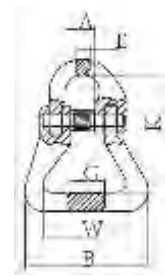

### SLR001 G80 WEB SLING CONNECTOR LINK Design Factor 4:1

ITEM #	SIZE mm	WT./kg.	W.L.L./lb.	Amm	Bmm	Kmm	Wmm	Gmm	Emm
6	001 Red	0.2	2100	15	60	56	40	18	7
7-8	001 Red	0.3	4400	206	1.5	63.7	40	24	9.5
10	001 Red	0.68	6900	24	66	83	49	30.5	11
13	001 Red	1.47	11600	28	88	93.7	55	36.8	16.5
16	001 Red	2.3	17600	34.5	108	120	65.5	45.2	19.8
20	001 Red	3.3	27500	41	129	138	80	51.8	23
22	001 Red	6.89	35000	50	191	180	126	70	26
26	001 Red	10.62	46700	58	28.4	209.5	152	82	30
32	001 Red	18.92	69400	72.5	252	279	160	91	55

Do Not Exceed Working Load Limit



### SLR270 G80 CLEVIS PEAR LINK Design Factor 4:1

ITEM #	SIZE mm	WT./kg.	W.L.L./lb.	A/mm	B/mm	D/mm	E/mm	Lmm
7-8	270 Red	0.53	4500	10	32.8	45	87	139
10	270 Red	0.74	7100	12	42	60	108	174
13	270 Red	1.76	12000	16.5	55.5	66.5	137.5	228
615353	16	270 Red	2.8	18000	19	68	72	165
18	270 Red	3.5	22400	23	73	98	185	317

Do Not Exceed Working Load Limit

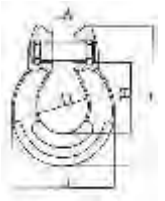

### SLR002 - G80 OMEGA LINK 80 Design Factor 4:1

ITEM #	SIZE mm	WT./kg.	W.L.L./lb.	A/mm	B/mm	D/mm	H/mm	L/mm
618001	06	083 Red	0.12	2100	8	41	20.5	25
618002	7-8	083 Red	0.22	4500	10	52	23.5	35
618003	10	083 Red	0.36	7100	12	62	31.5	40.5
618004	13	083 Red	0.71	12000	15	81	41	54
618005	16	083 Red	1.3	18100	19	99	49.5	64

Do Not Exceed Working Load Limit

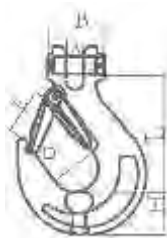

**GRADE 80****SLR012 CLEVIS SLING HOOK w/Latch**

ITEM #	SIZE mm	WT./kg.	W.L.L./lb.	Amm	Bmm	Ømm	Hmm	Kmm	Emm
618106	6 012 Red	0.32	2100	8	32	35	23	76	26
618108	7 012 Red	0.52	4500	9.5	37	37	32.5	85.5	29
618111	10 012 Red	1.05	7100	13	49	46	35	104	39
618114	13 012 Red	2	12000	16.5	56.5	56	42.5	128	47
618117	16 012 Red	3.7	18100	21.5	70.5	60	54	150	55
618119	20 012 Red	6	28300	24	77	79	58	180	61

Do Not Exceed Working Load Limit

**SP-SLR012 – CAST LATCH KIT**

ITEM #	SIZE mm	
618600	6	Latch Kit
618601	7-8	Latch Kit
618602	10	Latch Kit
618603	13	Latch Kit
618620	16	Latch Kit
618604	20	Latch Kit
618605	22	Latch Kit

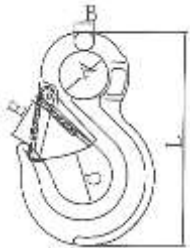
**SLR013 EYE SLING HOOK w/Latch Design Factor 4:1**

ITEM #	SIZE mm	WT./kg.	W.L.L./lb.	Ømm	Emm	Dmm	Ø mm	Lmm
618121	6 013 Red	0.3	2100	9	24	21	18	108
618123	7-8 013 Red	0.4	4500	11	30	26	22	133
618125	10 013 Red	0.9	7100	15	34	39	27	167
618127	13 013 Red	1.7	12000	19	39	54	32	213
618130	16 013 Red	3.2	18100	23	46	64	38	255
618131	20 013 Red	5.8	28300	24	40	80	45	305

Do Not Exceed Working Load Limit

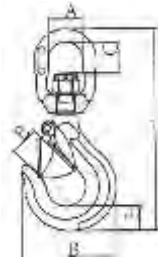
**SLR268 G80 SWIVEL HOOK with Latch Design Factor 4:1**

ITEM #	SIZE mm	WT./kg.	W.L.L./lb.	Amm	Bmm	Emm	Hmm	Cmm	Lmm
	7-8 268 Red	.85	4400	36	88.5	27	23.5	26	190
	10 268 Red	1.54	6900	42	104.5	32	29.5	34	233
	13 268 Red	3.04	11600	49	135	40	38	41	291.5
	16 268 Red	5.36	17600	61	161	45	45.4	53	352

Do Not Exceed Working Load Limit

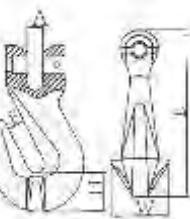
**SLR086 CLEVIS CRADLE GRAB HOOK Design Factor 4:1**

ITEM #	SIZE mm	WT./kg.	W.L.L./lb.	Emm	Amm	Hmm	Wmm	Lmm
618206	6 086 Red	0.25	2100	8.3	8	17.7	26.7	75
618207	7-8 086 Red	0.32	4500	11	9.5	18.5	33.5	89
618209	10 086 Red	0.73	7100	13	12.5	29	46	126
618213	13 086 Red	1.6	12000	16.5	15	42.5	57.5	163.5
618216	16 086 Red	2.8	18100	19	19.5	45.5	74	183.5
618217	20 086 Red	5	28300	24	23	56	74	219

Do Not Exceed Working Load Limit

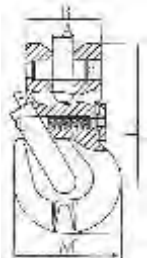
**SLR313 G80 CLEVIS GRAB HOOK 80 Design Factor 4:1**

ITEM #	SIZE mm	WT./kg.	W.L.L./lb.	Amm	Bmm	Emm	Mmm	Lmm
618640	6 313 Red	.28	2100	8	32	8	43.5	75
618641	7-8 313 Red	.33	4400	9.5	35	11	49.5	89
618641	10 313 Red	.88	6900	12.5	42.5	13.2	70.5	126.5
618642	13 313 Red	1.85	11600	15	53	16.5	90	163.5
618642	16 313 Red	3.24	17600	19.5	65.5	19.2	112.5	183.5

Do Not Exceed Working Load Limit

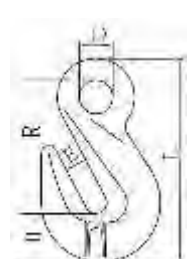
**SLR085 EYE CRADLE GRAB HOOK Design Factor 4:1**

ITEM #	SIZE mm	WT./kg.	W.L.L./lb.	Emm	Ømm	Hmm	Rmm	Lmm
618208	7-8 085 Red	.245	4500	10.8	17	18.5	60.5	88.5
618211	10 085 Red	0.65	7100	13	20	29	79.5	121.5
618214	13 085 Red	1.39	12000	16.5	26	42.8	99.7	158
618215	16 085 Red	2.2	18100	19.2	30	45.7	104	169
618218	20 085 Red	4.6	28300	24	37	56	140	219

Do Not Exceed Working Load Limit

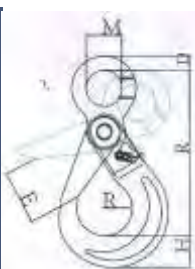
**GRADE 80**

<b>SLR081 – G80 EYE SELF LOCKING HOOK Design Factor 4:1</b>									
ITEM #	SIZE mm	WT./kg.	W.L.L./lb.	Mmm	Dmm	Rmm	Hmm	Emm	
	081-06	0.5	2100	22	110.5	10	34	19.5	28
	081-7-8	0.8	4500	25	136	12	46	24	34
	081-10	1.43	7100	32	171	15	56	30	44
	081-13	2.86	12000	40.5	208.5	19.5	69	40	52
	081-16	5.64	18100	56	257.5	22	86	50.5	60
	081-20	7.6	28000	64.5	275	27	100	55	81
	081-22	13	33600	70	320	30	98	67	82
	081-26	18	47500	80	363	34	110	75	110



<b>SLR082 CLEVIS SELF LOCKING HOOK Design Factor 4:1</b>									
ITEM #	SIZE mm	WT./kg.	W.L.L./lb.	Emm	Bmm	Hmm	Ømm	Rmm	
618227	7-8 082 Red	0.8	4500	34	9.5	24	46	121	
618230	10 082 Red	1.5	7100	44	12	28.5	56	146	
618234	13 082 Red	2.8	12000	52	15	40	69	182	
618236	16 082 Red	5.6	18100	60	18	50.5	86	218	
618239	20 082 Red	7.5	28300	83	25	55	100	240	
618247	22 082 Red	11.5	34200	88	25.5	67	98	276.5	

Do Not Exceed Working Load Limit

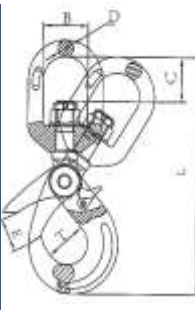

<b>SLR083 SWIVEL SELF LOCKING HOOK Design Factor 4:1</b>									
ITEM #	SIZE mm	WT./kg.	W.L.L./lb.	Bmm	Cmm	Dmm	Lmm	Tmm	Emm
618237	7-8 083 Red	1.1	4500	35.5	26	12.5	210	46	34
618240	10 083 Red	2.0	7100	42	34	15	247	56	44
618243	13 083 Red	4.0	12000	50	38.5	16	302	69	52
618246	16 083 Red	7.3	18100	61	55	21.5	383	86	60
618248	20 083 Red	11.6	28300	72	61	26	418	100	83

Do Not Exceed Working Load Limit

**SP-SLR081 – SLR082 – SLR083 TRIGGER PARTS**

ITEM #	SIZE mm	
618606	6	WILL FIT SP-SLR081 - 082 - 083
618607	7-8	WILL FIT SP-SLR081 - 082 - 083
618608	10	WILL FIT SP-SLR081 - 082 - 083
618609	13	WILL FIT SP-SLR081 - 082 - 083
618610	16	WILL FIT SP-SLR081 - 082 - 083
618611	20	WILL FIT SP-SLR081 - 082 - 083
618612	22	WILL FIT SP-SLR081 - 082 - 083

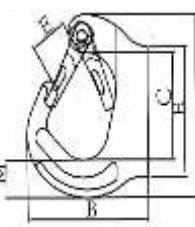

<b>SLR019 G80 WELD ON HOOK 80 Design Factor 4:1</b>										
ITEM #	SIZE	WT./kg.	W.L.L./lb.	Bmm	Cmm	Emm	Hmm	Mmm	Pmm	L
	019-2.0T Red	0.83	4400	92	67	30	81	23.3	34	114
	019-2.0T Red	1.2	6600	106	73.5	33.2	116	33.6	36	129
	019-2.0T Red	2.46	11000	133	94	39	159	44	43.5	171
	019-2.0T Red	3.26	17600	136.5	94	35	159	44	51	177
	019-2.0T Red	5.17	22000	169.5	134.5	50.5	194	54.7	53	223

Do Not Exceed Working Load Limit

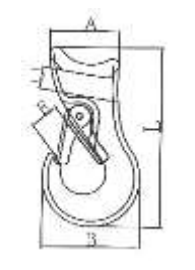

<b>SLR072 G80 SLIDING EYE CHOKER HOOK 80 Design Factor 4:1</b>									
ITEM #	SIZE	WT./kg.	W.L.L./lb.	Dmm	Amm	Bmm	Emm	Lmm	
	3/8-1/2 072 Red	0.68	3500	17	50	71	21	132	
618624	5/8 072 Red	1.21	4400	22	63.5	79	23	151.5	
618625	3/4 072 Red	1.99	6600	28	69	103	29	170	
618628	1 072 Red	4.18	11000	32.5	85.7	135	38	213	

Do Not Exceed Working Load Limit



<b>SLR116 G80 EYE FOUNDRY HOOK 80 Design Factor 4:1</b>									
ITEM #	SIZE mm	WT./kg.	WLL/lb.	Dmm	Lmm	Bmm	Rmm	Emm	HmmMmm
	6 116 Red	0.382	2100	20.5	133	100	102.7	49	17 19
	7-8 116 Red	0.72	4500	24	158.5	130	120.5	62	19 26
	10 116 Red	1.25	7100	31.5	199	152.5	153.5	73	25 31
	13 116 Red	2.32	12000	44	241.5	186	184	90	33 38.5
	16 116 Red	3.45	18000	49	279	218	216	105	37 41
	20 116 Red	6.42	28000	60	330	252	247	114	46 57

## DEFINITIONS

### WORKING LOAD LIMITS (WLL)

This is the maximum load in pounds, which should ever be correctly applied to an individual fitting or attachment when new and when the load is uniformly applied. Ratings given in ton (t) refer to metric ton equal 2,204 Lbs. TRYGGLOCK does not accept any liability or responsibility for injury or damage caused to a person or property resulting from the use of fittings or attachments in excess of the prescribed Working Load Limit (WLL).

### PROOF LOAD

This is the load in pounds which an attachment or fitting has withstood during the Proof Test carried out during the manufacturing process.

The Proof Load is generally twice the Working Load Limit (WLL).

### PROOF TEST

This is a test carried out during manufacture on attachments or fittings to be used for overhead lifting. The Proof Load, which is applied during the Proof Test, is shown on the Test Certificate.

### TEST CERTIFICATE

This is the certificate showing the results of the Proof Test issued with attachments or fittings to be used for overhead lifting.

### MINIMUM BREAKING LOAD

This is the minimum load in pounds, which when applied to a fitting or attachment, will cause it to fail in the manner prescribed by the appropriate lifting industry standard or specification.

### DESIGN FACTOR

The Design Factor is the ratio of the Minimum Breaking Load, to the Working Load Limit (WLL).

The design Factor for the TRYGGLOCK fittings or attachments is:

4:1, for chain for used with lifting slings.

5:1, for wire rope and synthetic materials for use with lifting slings.

## WARNINGS

TRYGGLOCK products are supplied on the express understanding that the buyer and/or the user is thoroughly familiar with their proper use, and application.

TRYGGLOCK assumes no responsibility for use or misuse of its products.

The only purpose of the following directions is to help the buyer and / or the user in the use and application of TRYGGLOCK products.

- ◆ **DO NOT** exceed specified Working Load Limits (WLL) relevant to the fittings or attachments, even when the load is uniformly applied and the fittings are in new condition.
- ◆ **DO NOT** use fittings or attachments, which are not in new condition. Working Load Limit (WLL) given in TRYGGLOCK literature, only apply to fittings or attachments in new condition and uniformly loaded.
- ◆ **DO NOT** use any fittings or attachments for a purpose for which they were neither intended nor designed. Any questions of application must be referred to TRYGGLOCK.
- ◆ **DO NOT** use any fitting or attachments for overhead lifting which are not manufactured from alloy steel and certified for overhead lifting use (Grade 80).
- ◆ **DO NOT** use any type of hook latch for supporting a load. TRYGGLOCK latches are designed for containment of sling materials only, in non-load or slack conditions. (except when specifically stated otherwise in TRYGGLOCK literature).  
Correct sling practice must never allow the load, wholly or partially to be supported by the latch. Continual inspection of fittings or attachments must include inspection of the latches to ensure correct operation.
- ◆ **DO NOT** use fittings or attachments without prior inspection for defects in the fittings or attachments. A continual system inspection of fittings and attachments must be carried out by qualified personnel, throughout the working lifetime of the fittings or attachments. Should any sign of wear or damage be detected, resulting in a deviation of 10% or more from the dimensions of the new fitting or attachment, then the fitting or attachment must be immediately replaced.  
  
In case of twist or damage, any deviation of 5% or more from the alignment of that of a new fitting or attachment, requires that the affected fitting or attachment must immediately be replaced.
- ◆ **DO NOT** use attachments with chain of type, grade and size different from the type grade and size recommended in TRYGGLOCK literature.

### TO SELECT AND ORDER THE PROPER CHAIN SLING

- 1 **DETERMINE THE WEIGHT AND CONFIGURATION OF THE LOAD TO BE LIFTED**
- 2 **DETERMINE THE TYPE OF CHAIN SLING REQUIRED ACCORDING TO THE WEIGHT AND CONFIGURATION.**
- 3 **DETERMINE THE SIZE CHAIN ACCORDING TO THE "WORKING LOAD LIMIT".**

**BE CAREFUL****3****USE OF TRYGGLOCK PRODUCTS UNDER THE FOLLOWING CONDITIONS  
REDUCES THE WORKING LOAD LIMIT OF THE FITTINGS OR ATTACHMENTS.****SHOCK LOAD** can cause an overload situation. Do not jerk the load. Pick it up slowly.**CONTINUOUS VIBRATION** can cause a fatigue effect. Refer to TRYGGLOCK for recommendations.**WORKING TEMPERATURE:** The following reductions in the Working Load Limit (WLL) **must** be used.

Chain, Fitting or Attachment Working Temperature	Reduction in Working Load Limit (WLL) when heated	Permanent Working Load Limit (WLL) Reduction after cooling.
100° F to 400° F ( -40° C to 200° C )	None	None
400° F to 600° F ( 200° C to 300° C )	10%	10%
600° F to 750° F ( 300° C to 400° C )	25%	25%
Less - 100° F ( -40° C ) : refer to TRYGGLOCK		

- ◆ **DO NOT** use fittings or attachments at temperatures below 100° F (40° C) and above 750° F (400°C) without specific reference to TRYGGLOCK
- ◆ **DO NOT** use alloy steel fittings or attachments in **acidic** and /or otherwise **corrosive** environments. Refer to TRYGGLOCK for Stainless Steel attachments.
- ◆ **DO NOT** carry out any **surface treatment**, including galvanization, without prior reference to TRYGGLOCK.
- ◆ **DO NOT** weld fittings or attachments whether to a support another fitting or attachment, or have items welded to the fittings or attachments without prior reference to TRYGGLOCK.
- ◆ **DO NOT** carry out any **heat treatment** of fittings or attachments under any circumstances, without prior reference to TRYGGLOCK.

**VARIATION IN THE INCLUDED ANGLE OF THE SLING LEGS:** The Working Load Limit (WLL) of a sling will decrease as the included angle increases in accordance with the following table.

## **GRADE 80** WORKING LOAD LIMITS/lb. FOR ALLOY STEEL SLINGS

ALLOY CHAIN		SINGLE LEG		DOUBLE LEG			TRIPLE AND QUAD LEG		
Size (in.)	mm	90°	60°	45°	30°	60°	45°	30°	
7/32	6	2,500	3,600	3,000	2,100	5,500	4,400	3,200	
1/4 - (9/32)	7	3,500	6,100	4,900	3,500	9,100	7,400	5,200	
5/16	8	4,500	7,800	6,400	4,500	11,700	9,500	6,800	
3/8	10	7,100	12,300	10,000	7,100	18,400	15,100	10,600	
1/2	13	12,000	20,800	17,000	12,000	31,200	25,500	18,000	
5/8	16	18,100	31,300	25,600	18,100	47,000	38,400	27,100	
3/4	20	28,300	49,000	40,000	28,300	73,500	60,000	42,400	
7/8	22	34,200	59,200	48,400	34,200	88,900	72,500	51,300	
1	26	47,700	82,600	67,400	47,700	123,900	101,200	71,500	
1-1/4	32	72,300	125,200	102,200	72,300	187,800	153,400	108,400	

Indicated W.L.L. corresponds to normal use with 4:1 design factor.

## **GRADE 100** WORKING LOAD LIMITS/lb. FOR ALLOY STEEL SLINGS

ALLOY CHAIN		SINGLE LEG		DOUBLE LEG			TRIPLE AND QUAD LEG		
Size (in.)	mm	90°	60°	45°	30°	60°	45°	30°	
9/32"	7	4,300	7,400	6,100	4,300	11,200	9,100	6,400	
5/16"	8	5,700	9,900	8,100	5,700	14,800	12,100	8,500	
3/8"	10	8,800	15,200	12,400	8,800	22,900	18,700	13,200	
1/2"	13	15,000	26,000	21,200	15,000	39,000	31,800	22,500	
5/8"	16	22,600	39,100	32,000	22,600	58,700	47,900	33,900	
3/4"	20	35,300	61,100	49,900	35,300	91,700	74,900	53,000	
7/8"	22	42,700	74,000	60,400	42,700	110,900	90,600	64,000	
1"	26	59,600	103,200	84,200	59,600	154,800	126,400	89,300	

Indicated W.L.L. corresponds to normal use with 4:1 design factor.

**GRADE 100**

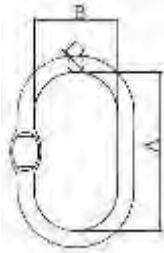

**SLR1011-G100 FORGED MASTER LINK**

ITEM #	SIZE mm	WT./kg.	WLL/lb.	A mm	B mm	D mm
619010	13	.34	5,060	110	60	13
619011	16	.53	7,700	110	60	16
619012	18	.86	11,000	135	75	18
619013	22	1.6	16,720	160	90	22
619014	26	2.46	22,000	180	100	26
619015	32	4.14	30,800	200	110	32

Ultimate Load is 4 times the Working Load Limit

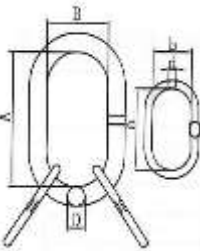

**SLR1012 G100 MASTER LINK ASSEMBLY**

ITEM #	SIZE mm	WT./kg.	WLL/lb.	Amm	Bmm	Dmm	ammm	bmm	dmm
619050	8	2.33	11,600	160	90	23	70	35	16.5
619051	13	6.5	30,800	200	110	33	115	50	23
619052	16	10.1	46,640	260	140	36	140	65	27

Ultimate Load is 4 times the Working Load Limit

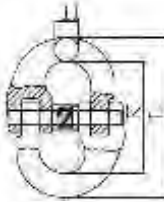

**SLR1001 G100 CONNECTING LINK**

ITEM #	SIZE mm	WT./kg.	WLL/lb.	Hmm	Amm	Kmm	Lmm
619021	8	.22	5,500	10	18.5	61.5	84.5
619022	10	.45	8,800	12.6	23	72	97.2
619023	13	1.15	15,000	16.8	27.5	89	127
619024	16	1.75	22,600	21	33.5	103	145

Ultimate Load is 4 times the Working Load Limit

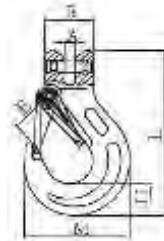

**SLR1004 G100 CLEVIS SLING HOOK WITH CAST LATCH**

ITEM #	SIZE mm	WT./kg.	WLL/lb.	Amm	Bmm	Emm	Hmm	Mmm	Lmm
619040	8	.7	5,500	9.5	37	25	27.5	88	134
619041	10	1.3	8,800	12	48	28	33.5	105.5	161.5
619042	13	2.3	15,000	15	59	38	42	134	203
619043	16	3.6	22,600	17.5	70	44	50	160.5	248

Ultimate Load is 4 times the Working Load Limit

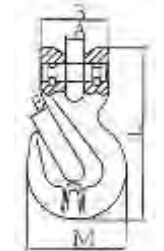

**SLR1009-G100 CLEVIS SHORTENING GRAB HOOK**

ITEM #	SIZE mm	WT./kg.	WLL/lb.	Amm	Bmm	Emm	Mmm	Lmm
619000	8	.34	5,500	9.5	36	10.8	53	91.5
619001	10	.82	8,800	12	46	13.5	72	126
619002	13	1.75	15,000	15	59	16.5	96	163.5
619003	16	2.88	22,600	17.5	70	19.2	112.5	183.5

Ultimate Load is 4 times the Working Load Limit



**SLR1006 G100 CLEVIS SELF LOCK HOOK**

ITEM #	SIZE mm	WT./kg.	WLL/lb.	Amm	Bmm	Emm	Hmm	Rmm	Mmm	Lmm
619031	8	.09	5,500	9.5	36	35.5	26	123	90	166
619032	10	1.6	8,800	12	46	45	30	144	109	196.5
619033	13	2.9	15,000	15	59	53.5	40.5	182	138.5	251
619034	16	5.8	22,600	17.5	70	62	50.5	217	170.5	303

Ultimate Load is 4 times the Working Load Limit

# BASIC SLING BUILDING INFORMATION

SECTION

# 3

## To Order a SINGLE LEG Chain Sling the following information is necessary



CHAIN SIZE	OVERALL REACH	SLING NAME	"GRADE" 80/100	QUANTITY ORDERED

EQUIPMENT SLING INSPECTOR: **NENAD GVOZDENOVIC** [nenadg@walcoequipment.com](mailto:nenadg@walcoequipment.com)



**FOR SPECIAL REQUESTS**  
Draw Your Sling Here

GRADE 80 ALLOY STEEL SLINGS		
CHAIN SIZE	SINGLE LEG 90° W.L.L.	
in.	mm	
7/32	6	2,500
1/4 (9/32)	7	3,500
5/16	8	4,500
3/8	10	7,100
1/2	13	12,000
5/8	16	18,100
3/4	20	28,300
7/8	22	34,200
1	26	47,700
1-1/4	32	72,300

GRADE 100 ALLOY STEEL SLINGS		
CHAIN SIZE	SINGLE LEG 90° W.L.L.	
in.	mm	
9/32	7	4,300
5/16	8	5,700
3/8	10	8,800
1/2	13	15,000
5/8	16	22,600
3/4	20	35,300
7/8	22	42,700
1	26	59,600



# BASIC SLING BUILDING INFORMATION

## To Order a DOUBLE LEG Chain Sling the following information is necessary



CHAIN SIZE	OVERALL REACH	SLING NAME	"GRADE" 80/100	QUANTITY ORDERED

EQUIPMENT SLING INSPECTOR: **NENAD GVOZDENOVIC** [nenadg@walcoequipment.com](mailto:nenadg@walcoequipment.com)



**DOSX**

**DOSL**

**DOG**

**DOSXA**

**DOSLA**

**DOF**



**DOGA**



**DOO**

**FOR SPECIAL REQUESTS**  
Draw Your Sling Here

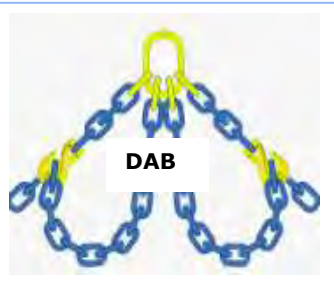

**DAB**



**DOG**

GRADE 80		ALLOY STEEL SLINGS		
CHAIN SIZE	DOUBLE LEG W.L.L.	60°	45°	30°
in.	mm			
7/32	6	3,600	3,000	2,100
1/4 (9/32)	7	6,100	4,900	3,500
5/16	8	7,800	6,400	4,500
3/8	10	12,300	10,000	7,100
1/2	13	20,800	17,000	12,000
5/8	16	31,300	25,600	18,100
3/4	20	49,000	40,000	28,300
7/8	22	59,200	48,400	34,200
1	26	82,600	67,400	47,700
1-1/4	32	125,200	102,200	72,300

GRADE 100		ALLOY STEEL SLINGS		
CHAIN SIZE	DOUBLE LEG W.L.L.	60°	45°	30°
in.	mm			
9/32	7	7,400	6,100	4,300
5/16	8	9,900	8,100	5,700
3/8	10	15,200	12,400	8,800
12"	13	26,000	21,200	15,000
5/8	16	39,100	32,000	22,600
3/4	20	61,100	49,900	35,300
7/8	22	74,000	60,400	42,700
1	26	103,200	84,200	59,600

# BASIC SLING BUILDING INFORMATION

SECTION

# 3

## Order a TRIPLE LEG Chain Sling the following information is necessary



CHAIN SIZE	OVERALL REACH	SLING NAME	"GRADE" 80/100	QUANTITY ORDERED

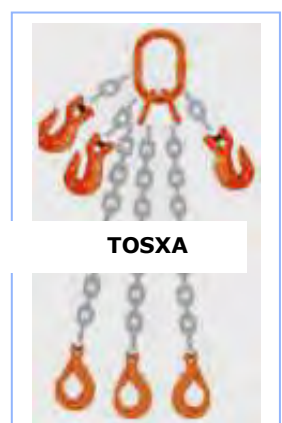

**FOR SPECIAL REQUESTS**  
Draw Your Sling Here

**GRADE 80 ALLOY STEEL SLINGS**

CHAIN SIZE in.	mm	TRIPLE & QUAD LEG W.L.L.		
		60°	45°	30°
7/32	6	5,500	4,400	3,200
1/4 (9/32)	7	9,100	7,400	5,200
5/16	8	11,700	9,500	6,800
3/8	10	18,400	15,100	10,600
1/2	13	31,200	25,500	18,000
5/8	16	47,000	38,400	27,100
3/4	20	73,000	60,000	42,400
7/8	22	88,900	72,500	51,300
1	26	123,900	101,200	71,500
1-1/4	32	187,800	153,400	108,400

**GRADE 100 ALLOY STEEL SLINGS**

CHAIN SIZE in.	mm	TRIPLE & QUAD LEG W.L.L.		
		60°	45°	30°
9/32	7	11,200	9,100	6,400
5/16	8	14,800	12,100	8,500
3/8	10	22,900	18,700	13,200
12"	13	39,000	31,800	22,500
5/8	16	58,700	47,900	33,900
3/4	20	91,700	74,900	53,000
7/8	22	110,900	90,600	64,000
1	26	154,800	126,400	89,300



# BASIC SLING BUILDING INFORMATION

To Order a **FOUR LEG Chain Sling**  
the following information is necessary



CHAIN SIZE	OVERALL REACH	SLING NAME	"GRADE" 80/100	QUANTITY ORDERED
_____	_____	_____	_____	_____



**FOR SPECIAL REQUESTS**  
Draw Your Sling Here

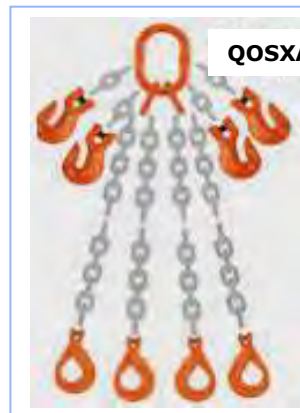

GRADE 80		ALLOY STEEL SLINGS		
CHAIN SIZE in.	mm	TRIPLE & QUAD LEG W.L.L.		
		60°	45°	30°
7/32	6	5,500	4,400	3,200
1/4 (9/32)	7	9,100	7,400	5,200
5/16	8	11,700	9,500	6,800
3/8	10	18,400	15,100	10,600
1/2	13	31,200	25,500	18,000
5/8	16	47,000	38,400	27,100
3/4	20	73,000	60,000	42,400
7/8	22	88,900	72,500	51,300
1	26	123,900	101,200	71,500
1-1/4	32	187,800	153,400	10,8400

GRADE 100		ALLOY STEEL SLINGS		
CHAIN SIZE in.	mm	TRIPLE & QUAD LEG W.L.L.		
		60°	45°	30°
9/32	7	11,200	9,100	6,400
5/16	8	14,800	12,100	8,500
3/8	10	22,900	18,700	13,200
12"	13	39,000	31,800	22,500
5/8	16	58,700	47,900	33,900
3/4	20	91,700	74,900	53,000
7/8	22	110,900	90,600	64,000
1	26	154,800	126,400	89,300



## MAGNETIC LIFTERS

ITEM #	PART #	RATED LIFTING CAPACITY	CYLINDRICAL LIFTING CAPACITY	MAXIMUM PULL-OUT FORCE kg.	L	B	H	R	OPERATION TEMPERATURE C	WT./ kg.
614988	PML-100	100	30	350	60	100	70	126	80	3
614982	PML-300	300	100	1050	94	168	96	155	80	10
614983	PML-600	600	200	2100	120	222	116	196	80	24
614984	PML-750	750	250	2625	120	222	116	196	80	34
614985	PML-1000	1000	300	3500	132	273	120	285	80	36
	PML-1500	1500	500	5250	152	360	173	426	80	50
614986	PML-2000	2000	750	7000	152	460	173	426	80	70
614987	PML-3000	3000	1000	10500	286	458	261	521	80	86
	PML-6000	6000	2000	21000	430	600	355	730	80	120

## LIFTING CLAMPS

ITEM #	MODEL	CAPACITY/TON	MIN/MAX JAW OPENING	WEIGHT
618700		.8	0 - 16 mm	
618701		1	0 - 22 mm	
618702		2	0 - 30 mm	
618703		3.2	0 - 40 mm	



## DRUM LIFTER

ITEM #	MAX LIFT CAPACITY	CHAIN LENGTH / DIAMETER	APROX. WEIGHT
615955	1 Ton	516 mm x 1/4"	8 lb.

FOR LIFTING STEEL DRUMS WITH CRANE, ELECTRIC HOIST OR CHAIN BLOCK.

### DANGER:

DO NOT USE WITH DRUM THAT HAS NO GRIP EDGE, AS GRABS COULD SLIP.

DO NOT EXCEED WORKING LOAD LIMIT.

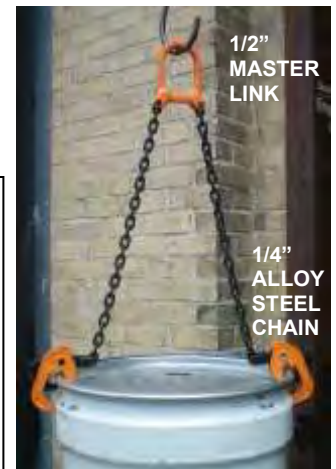
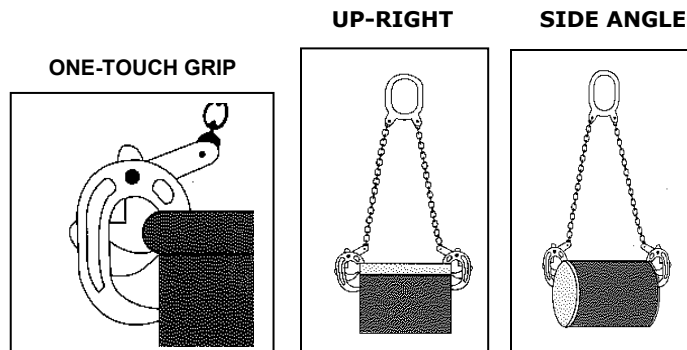

## WELDLESS SLING LINKS

◆ SELF COLOURED OR HOT GALVANIZED

◆ FORGED CARBON STEEL - QUENCHED & TEMPERED

PRICE EFFECTIVE SEPTEMBER 1, 2020

SIZE	STOCK #		W.L.L.	WEIGHT	DIMENSIONS IN INCHES						LIST
Inches	G-341	S-341	Sgl. Pull	Each	B	C	D	E	F		
A	GALV.	S.C.	lb.	lb.							
3/8	1013897	1013904	1800	13	1.13	.75	3.00	2.25	.38		
1/2	1013913	1013922	2900	.55	1.50	1.00	4.00	3.00	.50		
5/8	1013931	1013940	4200	1.10	1.87	1.25	5.00	3.75	.63		
3/4	1013959	1013968	6000	1.95	2.25	1.50	6.00	4.50	.75		
7/8	1013977	1013986	8300	2.78	2.63	1.75	7.00	5.25	.88		
1	1013995	1014002	10800	4.30	3.00	2.00	8.00	6.00	1.00		
1-1/4	1014011	1014020	16750	8.50	4.00	2.50	10.25	7.50	1.25		
1-3/8	1014039	1014048	20500	11.50	4.13	2.75	11.00	8.25	1.38		

Ultimate Load is 6 times the Working Load Limit.

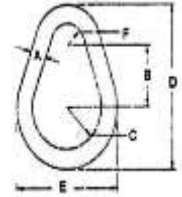

## WELDLESS END LINKS

◆ SELF COLOURED OR HOT DIP GALVANIZED.

◆ FORGED CARBON STEEL - QUENCHED AND TEMPERED.

S-340, Form 5/16" Through 7/8" - Meet the Requirements of Federal Specification RR-C 271D Type XV

SIZE	STOCK #		W.L.L.	WEIGHT	DIMENSIONS"			LIST
A	G-340	S-340	LB.	EACH	B	C	D	
In.	GALV.	S.C.	LB.	LB.				
5/16	1014057	1014066	2500	.15	.50	1.75	1.18	
3/8	1014075	1014084	3800	.23	.56	1.88	1.38	
1/2	1014093	1014100	6500	.45	.75	2.38	1.81	
5/8	1014119	1014128	9300	.95	1.00	3.25	2.32	
3/4	1014137	1014146	14000	1.51	1.13	3.50	2.68	
7/8	1014155	1014164	12000	2.75	2.00	5.13	3.75	
1	1014173	1014182	15200	3.95	2.25	5.75	4.25	
1-1/4	1014191	1014208	26400	7.30	2.50	7.00	5.00	
1-3/8	1014217	1014226	30000	10.38	2.75	7.75	5.50	

Ultimate Load is 5 times the Working Load Limit.

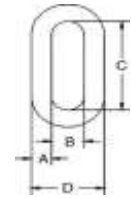

## WELDLESS RINGS

SELF COLOUR - FORGED CARBON STEEL - QUENCHED AND TEMPERED

Weldless rings meet the requirements of Federal Specifications RR-C271D type VI

SIZE	S-643	W.L.L./lb.	WEIGHT/lb.	DIMENSIONS	
A	STOCK #	Sgl. Pull	EACH	B	C
INCHES	S.C.				
7/8x4	1013780	7200	2.70	4.00	5.75
7/8x5-1/2	1013806	5600	3.40	5.50	7.25
1x4	1013824	10800	3.50	4.00	6.00
1-1/8x6	1013842	10400	6.50	6.00	8.25
1-1/4x5	1013860	17000	7.00	5.00	7.50
1-3/8x6	1013888	19000	10.63	6.00	8.75

Ultimate Load is 6 times the Working Load Limit.

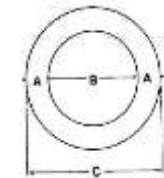

## WELD ON HOOK - D 16 DESIGN FACTOR 4:1

SIZE	WWL	WLL	B	E	F	H	WEIGHT	REF. #
	T <sub>r</sub>	LB.	IN.	IN.	IN.	IN.	LB.	
616501	2.00	4400	.91	3.82	3.58	1.06	1.85	D-1601R
616502	3.00	6600	1.14	4.61	4.13	1.22	2.60	D-1615R
616504	4.00	8800	1.34	5.16	4.49	1.42	4.19	D-1616R
616505	5.00	11000	1.34	6.34	5.24	1.77	5.62	D-1602R
616510	10.00	22000	1.93	8.07	6.61	2.24	11.02	D-1604R

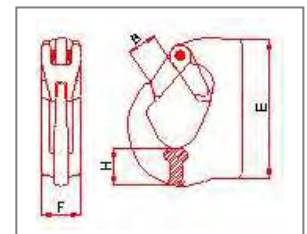

**LEVER HOIST HSH-A**

ITEM #	CAPACITY TON	STANDARD LIFT	RUNNING TEST LOAD	LOAD RATING	# OF LOAD CHAINS	LOAD CHAIN STRANDS	NET WEIGHT kg
615900	.75	1.5 m	11 kn	140	1	6 mm	7
615901	1.5	1.5 m	22.5 kn	220	1	7.1 mm	10
615903	3	1.5 m	37.5 kn	320	1	10 mm	17.5
615905	6	1.5 m	75 kn	340	2	10 mm	28.5

**CHAIN HOIST HSZ-A**

ITEM #	CAPACITY TON	STANDARD LIFT	RUNNING TEST LOAD	LOAD RATING	# OF LOAD CHAINS	LOAD CHAIN STRANDS	NET WEIGHT kg.
615910	1	2.5 m	12.5 kn	309 n	1	6 mm	10.5
615912	1.5	2.5 m	18.8 kn	320 n	1	7.1 mm	17
615914	2	3 m	25 kn	320 n	1	8 mm	18
615917	3	3 m	37.5 kn	360 n	2	7.1 mm	22
615918	5	3 m	62.5 kn	414 n	2	9 mm	40

**SNATCH BLOCKS**
**SWIVEL HOOK**

ITEM #	SHEAVE SIZE	W.L.L. TONS	CABLE DIA.	WEIGHT LB./PC.
605370	3"	2	3/8"	3
605371	4-1/2"	4	1/2"	12
605368	6"	8	3/4"	28
	8"	8	3/4"	34

**SWIVEL SHACKLE**

ITEM #	SHEAVE SIZE	W.L.L. TONS	CABLE DIA.	WEIGHT LB./PC.
605375	3"	2	3/8"	3
605376	4-1/2"	4	1/2"	13
605381	6"	8	3/4"	29
	8"	8	3/4"	36

**TAIL BOARDS**

ITEM #	SHEAVE SIZE	W.L.L. TONS	CABLE DIA.	WEIGHT LB./PC
605382	3"	2	3/8"	2
605380	4-1/2"	4	1/2"	7.5
	6"	8	3/4"	16
	8"	15	3/4"	23



**CAUTION: Do not Exceed Working Load Limit.**

OTHER SNATCH BLOCKS AVAILABLE UPON REQUEST - Call for pricing

**WIRE ROPE – BRIGHT, FIBRE CORE**

ITEM #	DIAMETER	DESCRIPTION	IPS B/S	WEIGHT
			Tons	LB./Ft.
605250	1/4"	Self Colour 6 x 19	2.7	.10
	5/16"	Self Colour 6 x 19	4.1	.16
	3/8"	Self Colour 6 x 19	6	.23
605276	7/16"	Self Colour 6 x 19	8	.31
605264	1/2"	Self Colour 6 x 19	11	.40
	9/16"	Self Colour 6 x 19	13	.51
605265	5/8"	Self Colour 6 x 19	16	.63
	3/4"	Self Colour 6 x 19	23	.90
	7/8"	Self Colour 6 x 19	32	1.23
	1"	Self Colour 6 x 19	41	1.60
	1-1/8"	Self Colour 6 x 19	53	2.03
	1-1/4"	Self Colour 6 x 19	65	2.50
	1-3/8"	Self Colour 6 x 19	81	3.03
	1-1/2"	Self Colour 6 x 19	96	3.60

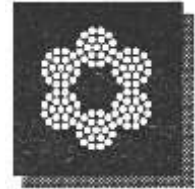

**FIBRE CORE - 2500' REEL**

605255	1/2"	Self Colour 6 x 25	11	.40
--------	------	--------------------	----	-----

**IWRC**

ITEM #	DIAMETER	DESCRIPTION	IPS B/S	WEIGHT
			Tons	Lbs./Ft
605252	1/4"	Self Colour 6 x 19	2.9	.11
	5/16"	Self Colour 6 x 19	4.4	.17
	3/8"	Self Colour 6 x 19	6.4	.25
605276	7/16"	Self Colour 6 x 19	8.6	.34
605263	1/2"	Self Colour 6 x 19	11.8	.44
	9/16"	Self Colour 6 x 19	14.3	.56
605266	5/8"	Self Colour 6 x 19	17.7	.69
605268	3/4"	Self Colour 6 x 19	25.5	.99
	7/8"	Self Colour 6 x 19	34.4	1.35
605352	1"	Self Colour 6 x 19	44.8	1.76
	1-1/8"	Self Colour 6 x 19	56.9	2.23
	1-1/4"	Self Colour 6 x 19	70.4	2.75
	1-3/8"	Self Colour 6 x 19	87.0	3.33
	1-1/2"	Self Colour 6 x 19	103.2	3.96

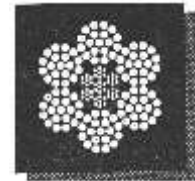

**BRIGHT IWRC – 2500' REEL**

ITEM #	DIAMETER	DESCRIPTION	PS B/S	WEIGHT
605253	3/8"	Self Colour 6 x 25		
605256	1/2"	Self Colour 6 x 25	11.8	.44
605275	7/8"	Self Colour 6 x 25		

**IWRC – 2500' REEL**

ITEM #	DIAMETER	DESCRIPTION	IPS B/S	WEIGHT	LIST PRICE
605257	1/2"	Galvanized 6 x 26			

**IWRC - BRIGHT- 2500' REEL**

ITEM #	DIAMETER	DESCRIPTION	ISP B/S	WEIGHT
			TONS	LB./FT.
605269	1/4"	Self Colour 6 x 37	2.6	.11
	5/16"	Self Colour 6 x 37	4.3	.17
	3/8"	Self Colour 6 x 37	5.9	.24
605270	7/16"	Self Colour 6 x 37	8.0	.33
	1/2"	Self Colour 6 x 37	10.7	.43
	9/16"	Self Colour 6 x 37	13.4	.54
605274	5/8" EIPS	Self Colour 6 x 37	17.2	.67
605274	3/4" EIPS	Self Colour 6 x 37	23.8	.96
	7/8"	Self Colour 6 x 37	32.4	1.31
	1"	Self Colour 6 x 37	42.4	1.70
	1-1/8"	Self Colour 6 x 37	52.6	2.16
	1-1/4"	Self Colour 6 x 37	65.5	2.66
	1-3/8"	Self Colour 6 x 37	80.0	3.22
	1-1/2"	Self Colour 6 x 37	96.7	3.84

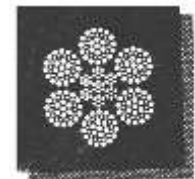

**6 X 37 - FIBRE CORE**

ITEM #	DIAMETER	ISP B/S TONS	WEIGHT LB./FT.
	1/4"	2.5	.10
	5/16"	4.0	.16
	3/8"	5.5	.22
	7/16"	7.5	.30
	1/2"	10.0	.39
	9/16"	12.5	.49
	5/8"	16.0	.61
	3/4"	22.2	.87
	7/8"	30.2	1.19
	1"	39.5	1.55
	1-1/8"	49.0	1.96
	1-1/4"	61.0	2.42
	1-3/8"	74.5	2.93
	1-2/2"	90.0	3.49

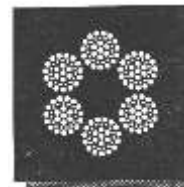
**18 x 7 - ISP - ROTATION RESISTANT**

ITEM #	DIAMETER	NBS B/S 110/120	WEIGHT LB./FT.
	1/4"	2.5	.10
	5/16"	3.8	.17
	3/8"	5.6	.24
605261	7/16"	7.6	.33
605262	1/2"	9.8	.43
	9/16"	12.4	.55
605267	5/8"	15.3	.68
	3/4"	21.8	.97

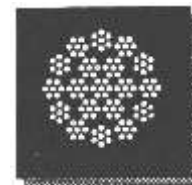
**6 x 19 - IWRC - SWAGGED - FOR LOGGING**

ITEM #	DIAMETER SWAGGED	ISP B/S TONS	WEIGHT LB./FT.
	1/2"	15.9	.57
	9/16"	19.3	.79
605272	5/8"	24.5	.97
	11/16"	29.6	1.18

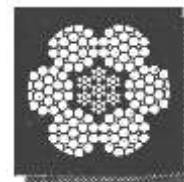
**AIRCRAFT CABLE - 7 X 7 CONSTRUCTION - GALVANIZED**

ITEM #	DIAMETER	NOM B/S LB.	WEIGHT LB./1000'
605220	1/16"	480	7.5
605221	3/32"	920	16.0
605222	1/8"	1,700	28.5
605223	3/16"	3,700	62

On 5000 m 2500 ft. Reels

**7 X 19 CONSTRUCTION**

ITEM #	DIAMETER	NOM.B/S LB.	WEIGHT LB./1000'
605205	1/8"	2,000	29
605204	3/16"	4,200	65
605207	1/4"	7,000	110
605208	5/16"	9,800	173
605211	3/8"	14,400	243
605212	1/2"	19,140	440

On 5000 m 2500 ft. Reels

**7 X 7 CONSTRUCTION - GALVANIZED COATED**

ITEM #	DIAMETER	COATING	NOM.B/S LB.	WT. LB./M'
605202	1/8" 3/16"	Clear PVC	1700	37

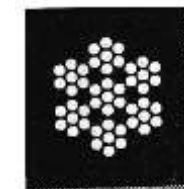
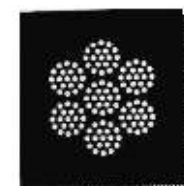
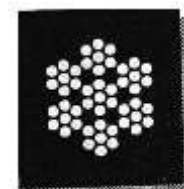

AIRCRAFT CABLE - Designed for industrial and marine use only!

**AIRCRAFT CABLE - COATED**

ITEM #	DIAMETER		PVC COATING	DESCRIPTION	B/S LB.	WT. LB./M'
	CABLE					
605351	1/8"	3/16"	Clear	Galvanized 7 x 19	2000	37
605226	1/4"	3/16"	Black	Galvanized 7 x 19	2000	37
605467	3/16"	1/4"	Clear	Galvanized 7 x 19		76

**WIRE ROPE REELS**

ITEM #	DIAMETER	DESCRIPTION	FEET
605540	1/8	Galvanized 7 x 19	250'
605541	3/16	Galvanized 7 x 19	250'
605542	1/4	Galvanized 7 x 19	250'
605543	5/16	Galvanized 7 x 19	250'
605544	3/8	Galvanized 7 x 19	250'
605551	3/16	Galvanized 7 x 19	1000'
605552	1/4	Galvanized 7 x 19	1000'
605550	5/16	Galvanized 7 x 19	1000'
605553	3/8	Galvanized 7 x 19	1000'
605547	1/16	Galvanized 7 x 7	250'
605546	3/32	Galvanized 7 x 7	250'
605545	1/8	Galvanized 7 x 7	250'
605571	1/16"	Galvanized 7 x 7	500'
605570	3/32"	Galvanized 7 x 7	500'

**CLEAR COATED**

605575	3/16" to 1/4"	Galvanized 7 x 19	250'
605576	3/32" to 1/8"	Galvanized 7 x 7	250'
605577	1/8" to 3/16	Galvanized 7 x 7	250'

**AIRCRAFT CABLE -TYPE 302/304**

ITEM #	DIAMETER	DESCRIPTION	NOM B/S	WEIGHT
			LB.	LB./1000'
605229	3/64"	Stainless 7 x 7	270	4.2
	1/16"	Stainless 7 x 7	480	7.5
605436	3/32"	Stainless 7 x 7	920	16.0
	1/8"	Stainless 7 x 7	1,700	28.5

ITEM #	DIAMETER	DESCRIPTION	NOM B/S	WEIGHT
			LB.	LB./1000'
605228	3/32"	Stainless 7 x 19	1,050	16
605230	1/8"	Stainless 7 x 19	1,760	29
605227	5/32"	Stainless 7 x 19	2,400	45
605231	3/16"	Stainless 7 x 19	3,700	65
605232	1/4"	Stainless 7 x 19	6,400	110
605233	5/16"	Stainless 7 x 19	9,000	173
605235	3/8"	Stainless 7 x 19	12,000	243
	3/8"	Stainless 7 x 19	12,000	243 2500 Roll

ITEM #	DIAMETER	DESCRIPTION	NOM B/S	WEIGHT
			LB.	LB./1000'
605239	1/4"	Stainless 1 x 19	8,200	135

**AIRCRAFT CABLE - COATED WHITE PVC**

ITEM #	DIAMETER		DESCRIPTION	NOM.B/S LB.	WEIGHT LB./M'
	CABLE	COATING			
605234	1/16"	3/32"	Stainless 7 x 7	480	9.3
	3/32"	1/8"	Stainless 7 x 7	920	19
	3/32"	5/32"	Stainless 7 x 7	920	24
605469	1/8"	3/16"	Stainless 7 x 7	1700	42
	1/8"	1/4"	Stainless 7 x 7	1700	4
	3/16"	5/16"	Stainless 7 x 7	3700	92

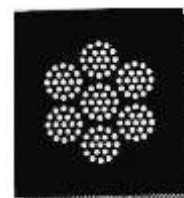

PRICES EFFECTIVE SEPTEMBER 1, 2020

**MALLEABLE WIRE ROPE CLIPS - GALVANIZED**

ITEM #	SIZE CABLE DIA.	WEIGHT/LB. PER/100
503418	1/8"	4
503419	3/16"	6
503420	1/4"	10
503421	5/16"	12
503422	3/8"	23
503423	1/2"	40
503424	5/8"	
503425	3/4"	82
503427	7/8"	125
503428	1"	150

**WIRE ROPE CLIPS - FORGED**

ITEM #	SIZE CABLE DIA.	WEIGHT/LB. PER/100
503413	3/16"	10
503414	1/4"	17
503415	5/16"	28
503440	3/8"	40
503432	7/16"	
503441	1/2"	65
503442	5/8"	95
503416	3/4"	140
503443	7/8"	215

**WIRE ROPE CLIPS - STAINLESS STEEL (T316)**

ITEM #	SIZE CABLE DIA.	WEIGHT/LB. PER/100
617204	1/8" - 5/32"	4
617205	3/16"	8
617206	1/4"	9
617208	5/16"	17
617210	3/8"	35
617213	1/2"	48

**WIRE ROPE THIMBLES - GALVANIZED / ZINC**

ITEM #	CABLE SIZE DIA./INCHES	WEIGHT/LB. PER/100
604318	1/8	2.2
604319	3/16	2.5
604320	1/4	2.5
604322	5/16	4.4
604324	3/8	7.6
604326	1/2	11.3
604328	5/8	30.0
604329	3/4	37.0
	7/8	73.0
	1	100.0

**HEAVY DUTY THIMBLES - TYPE 3**

ITEM #	CABLE SIZE DIA./INCHES	WEIGHT/LB. PER/100
604332	1/4"	8
604333	5/16"	14
604334	3/8"	44
604335	1/2"	74
604336	5/8"	115
604330	3/4"	150
604338	7/8"	225
	1"	336



**SWAGE SLEEVES - ALUMINUM**

ITEM #	CABLE DIA./ INCHES	TYPE
604360	1/16	Oval
604363	1/16	Stop
604362	3/32	Oval
604375	3/32	Stop
604367	1/8	Oval
604365	1/8	Stop
604366	3/16	Oval
604364	3/16	Stop
604368	3/16	Spools
604369	1/4	Oval
604376	1/4	Stop
604370	5/16	Oval
604371	3/8	Oval

COPPER SWAGE SLEEVES AVAILABLE

**SWAGING TOOLS****FOR ALUMINUM AND COPPER TOOLS**

ITEM #	MODEL	LENGTH	WEIGHT / LB
	#1 HSC 600	26"	6.5
	#1 HS 600 B	20"	6.5
	Jaw Set for Bench		

**WIRE ROPE CUTTERS - IMPACT TYPE**

ITEM #	CAPACITY	
605200	1	5/8"
	1 A	1-1/16"
	2	1-1/2"

**WIRE ROPE & CABLE CUTTERS "ECONO LINE"**

ITEM #	MODEL	LENGTH	WEIGHT
	C-7	8"	0.63
	C-9	13"	1.63

## WIRE ROPE 2 LEG SLING

DIAMETER INCHES	60°	45°	30°
1/4	2,210	1,820	1,300
5/16	3,400	2,800	2,000
3/8	4,760	3,920	2,800
7/16	6,460	5,320	3,800
1/2	8,500	7,000	5,000
9/16	10,880	8,960	6,400
5/8	13,260	10,920	7,800
3/4	19,040	15,680	11,200
7/8	25,840	21,280	15,200
1	33,320	27,440	19,600
1-1/8	40,800	33,600	24,000
1-1/4	51,000	42,000	31,000



## 3 LEG SLING

DIAMETER INCHES	60°	45°	30°
1/4	3,400	2,800	1,940
5/16	5,200	4,200	3,000
3/8	7,400	5,000	4,400
7/16	10,000	8,200	5,800
1/2	13,200	10,800	7,600
9/16	16,600	13,600	9,600
5/8	20,000	16,600	11,800
3/4	30,000	24,000	16,800
7/8	40,000	32,000	22,000
1	52,000	42,000	30,000
1-1/8	62,000	52,000	36,000
1-1/4	76,000	62,000	44,000



## 4 LEG SLING

DIAMETER INCHES	60°	45°	30°
1/4	4,400	3,600	2,600
5/16	7,000	5,600	4,000
3/8	10,000	8,200	5,800
7/16	13,400	11,000	7,800
1/2	17,600	14,200	10,200
9/16	22,000	18,000	12,800
5/8	28,000	22,000	15,600
3/4	38,000	32,000	22,000
7/8	52,000	42,000	30,000
1	68,000	56,000	40,000
1-1/8	84,000	68,000	48,000
1-1/4	102,000	84,000	60,000



DIAMETER INCHES	VERTICAL	CHOKER	BASKET
1/4	1,300 lb.	960 lb.	2,600
5/16	2,000	1,400	4,000
3/8	2,800	2,200	5,800
7/16	3,800	2,800	7,800
1/2	5,000	3,800	10,200
9/16	6,400	4,800	12,800
5/8	7,800	5,800	15,600
3/4	11,200	8,200	22,000
7/8	15,200	11,200	30,000
1	19,600	14,400	40,000
1-1/8	24,000	18,200	48,000
1-1/4	30,000	22,000	60,000
1-1/2	42,000	32,000	84,000

DO NOT EXCEED LIFT CAPACITY

VERTICAL



CHOKER



BASKET



**GALVANIZED WIRE ROPE SLINGS**  
**Steel Core (IWRC)**

**SINGLE LEG STANDARD**  
**LOOP WIRE ROPE SLINGS**

Standard: Eyes Each End  
 Other Configurations  
 Available on Request.

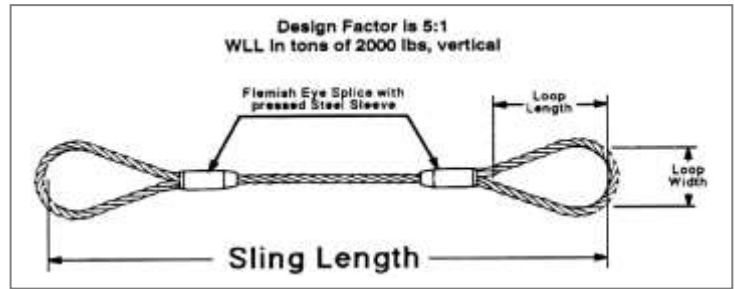

**LIST PRICES, SEPTEMBER 1, 2020**  
 PRICE FOR EACH SLING WITH STEEL CORE, READY TO USE

<b>LOOP SIZE*</b>	<b>4 X 2</b>	<b>4 X 2</b>	<b>8 X 4</b>	<b>10 X 5</b>	<b>12 X 6</b>	<b>14 X 7</b>
<b>SLING DIA.</b>	<b>1/4"</b>	<b>3/8"</b>	<b>1/2"</b>	<b>5/8"</b>	<b>3/4"</b>	<b>7/8"</b>
<b>WLL TONS</b>	<b>.65</b>	<b>1.4</b>	<b>3.2</b>	<b>3.9</b>	<b>5.6</b>	<b>7.6</b>

LONG ITEM #	LIST
2'	
3'	
4'	
5'	
6'	
8'	
10' -----	
12' -----	
15' -----	
20' -----	

Prices subject to change without notice. \*Loop Length x Width in inches Multi-Leg Bridle Slings available on request

**STEEL WIRE ROPE**  
**STEEL CORE (IWRC)**

**SINGLE LEG STANDARD**  
**LOOP WIRE ROPE SLINGS**

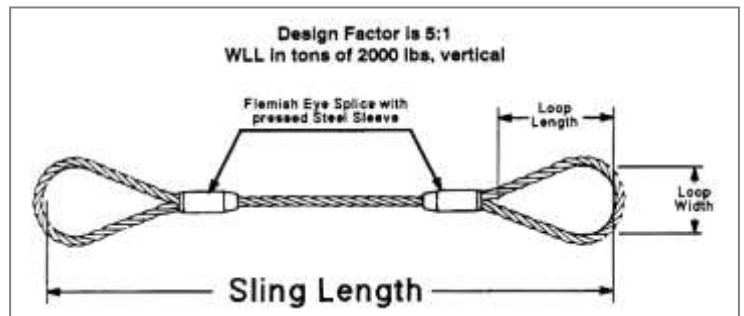

LOOP SIZE*
SLING DIA.
WLL TONS
LENGTH
5 Ft.
6 Ft.
8 Ft.
10 Ft.
12 Ft.
15 Ft.

20 Ft. \*Loop Length x Width in inches Multi-Leg Bridle Slings available on request.

**TURNBUCKLES HOT GALVANIZED - DROP FORGED** LIST PRICE, SEPTEMBER 1, 2020

ITEM #	SIZE	WLL/LB.	WEIGHT
	DIA. X TAKE-UP	H&H-H&E	LB.
605131	3/8 x 6"	1,000	.75
605148	1/2 x 6"	1,500	1.50
605013	1/2 x 9"	1,500	1.75
605132	1/2 x 12"	1,500	2.18
605133	5/8 x 6"	2,250	2.63
605134	5/8 x 9"	2,250	3.00
605149	5/8 x 12"	2,250	3.25
605135	3/4 x 6"	3,000	3.75
605136	3/4 x 9"	3,000	4.50
605137	3/4 x 12"	3,000	5.75
605138	7/8 x 12"	4,000	8.38
605139	7/8 x 18"	4,000	10.25
605140	1 x 12"	5,000	11.25
605141	1 x 18"	5,000	14.00
605143	1-1/4x12"	5,000	19.00
605144	1-1/4x18"	5,000	24.10

ITEM #	SIZE	WLL/LB.	WEIGHT
	DIA. X TAKE-UP	E&E	LB.
605219	3/8 x 6"	1,200	.75
605064	1/2 x 6"	2,200	1.50
605187	1/2 x 9"	2,200	1.75
605215	1/2 x 12"	2,200	2.18
605169	5/8 x 6"	3,500	2.63
605238	5/8 x 9"	3,500	3.00
605191	5/8 x 12"	3,500	3.25
605176	3/4 x 6"	5,200	3.75
605070	3/4 x 9"	5,200	4.50
605198	3/4 x 12"	5,200	5.75
605145	3/4 x 18"	5,200	7.00
605199	7/8 x 12"	7,200	8.38
605071	7/8 x 18"	7,200	10.25
605152	1 x 12"	10,000	11.25
605072	1 x 18"	10,000	14.00
605158	1-1/4x12"	15,200	19.00
605073	1-1/4x18"	15,200	24.10
605170	1-1/2x12"	21,400	27.00

ITEM #	SIZE	WLL/LB.	WEIGHT
	DIA. X TAKE-UP	J & J	LB.
605188	3/8 x 6"	1,200	.93
605214	1/2 x 6"	2,200	1.68
605186	1/2 x 9"	2,200	1.85
605189	1/2 x 12"	2,200	2.20
605192	5/8 x 6"	3,500	2.82
605193	5/8 x 9"	3,500	3.25
605190	5/8 x 12"	3,500	3.75
605194	3/4 x 6"	5,200	4.68
605195	3/4 x 9"	5,200	5.38
605196	3/4 x 12"	5,200	6.12
605197	3/4 x 18"	5,200	7.75
605075	7/8 x 12"	7,200	9.38
605076	7/8 x 18"	7,200	1.44
605180	1 x 6"	10,000	
605159	1 x 12"	10,000	12.88
605077	1 x 18"	10,000	16.10
605078	1 x 24"	10,000	18.60
605079	1-1/4x12"	15,200	23.6
605080	1-1/4x18"	15,200	26.6
605171	1-1/4 x 24"		

NOTE: All Turnbuckles with stop nuts

**Hook & Hook****Eye & Eye****Jaw & Jaw**

## NYLON SLINGS

CAPACITY / LB.

5 To 1 Safety Factor

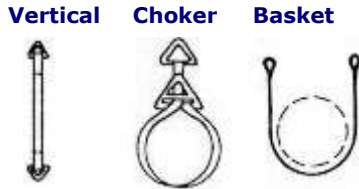

SINGLE PLY



DOUBLE PLY

WIDTH	REFERENCE #	Vertical	Choker	Basket	REFERENCE	Vertical	Choker	Basket	#
1"	EE1-901-T3	1600	1200	3200	EE2-901-T3	3200	2400	6400	
1"	EE1-901-T4	1600	1200	3200	EE2-901-T4	3200	2400	6400	
1"	EN1-901	3200	2250	6400	EN2-901	6400	5100	12,800	
2"	TC1-902	3200	2400	6400	TC2-902	6400	4800	12,800	
2"	TT1-902	3200		6400	TT2-902	6400		12,800	
2"	EE1-902-T3	3200	2400	6400	EE2-902-T3	6400	4800	12,800	
2"	EE1-902-T4	3200	2400	6400	EE2-902-T4	6400	4800	12,800	
2"	EN1-902	6400	5100	12,800	EN2-902	12,400	9900	24,800	
3"	TC1-903	4800	3600	9600	TC2-903	8800	6600	17,600	
3"	TT1-903	4800		9600	TT2-903	8800		17,600	
3"	EE1-903-T3	4800	3600	9600	EE2-903-T3	8800	6600	17,600	
3"	EE1-903-T4	4800	3600	9600	EE2-903-T4	8800	6600	17,600	
3"	EN1-903	9400	7050	18,800	EN2-903	17,600	13,200	24,800	
4"	TC1-904	6400	4800	12,800	TC2-904	11,500	8600	23,000	
4"	TT1-904	6400		12,800	TT2-904	11,500		23,000	
4"	EE1-904-T3	6400	4800	12,800	EE2-904-T3	11,500	8600	23,000	
4"	EE1-904-T4	6400	4800	12,800	EE2-904-T4	11,500	8600	23,000	
4"	EN1-904	12,400	9300	24,800	EN2-904	22,000	17,600	44,000	
5"	TC1-905	8000	6000	16,000	TC2-905	13,700	10,300	27,400	
5"	TT1-905	8000		16,000	TT2-905	13,700		27,400	
5"	EE1-905-T3	8000	6000	16,000	EE2-905-T3	13,700	10,300	27,400	
5"	EE1-905-T4	8000	6000	16,000	EE2-905-T4	13,700	10,300	27,400	
5"	EN1-905	15,000	12,000	30,000	EN2-905	27,500	22,000	55,000	
6"	TC1-906	9600	7200	19,200	TC2-906	16,500	12,400	33,000	
6"	TT1-906	9600		19,200	TT2-906	16,500		33,000	
6"	EE1-906-T3	9600	7200	19,200	EE2-906-T3	16,500	12,400	33,000	
6"	EE1-906-T4	9600	7200	19,200	EE2-906-T4	16,500	12,400	33,000	
6"	EN1-906	18,600	14,000	37,200	EN2-906	33,000	24,800	66,000	
8"	TC1-908	12,800	9600	25,600	TC2-908	22,000	16,500	40,000	
8"	TT1-908	12,800		25,600	TT2-908	22,000		40,000	
8"	EE1-908-T3	12,800	9600	25,600	EE2-908-T3	22,000	16,500	40,000	
8"	EE1-908-T4	12,800	9600	25,600	EE2-908-T4	22,000	16,500	40,000	
8"	EN1-908	22,000	17,600	44,000	EN2-908	40,000	32,000	80,000	
10"	TC1-910	16,000	12,000	32,000	TC2-910	24,000	18,000	48,000	
10"	TT1-910	16,000		32,000	TT2-910	24,000		48,000	
10"	EE1-910-T3	16,000	12,000	32,000	EE2-910-T3	24,000	18,000	48,000	
10"	EE1-910-T4	16,000	12,000	32,000	EE2-910-T4	24,000	18,000	48,000	
10"	EN1-910	25,500	20,400	51,000	EN2-910	47,000	37,600	94,000	
12"	TC1-912	19,200	4,400	38,400	TC2-912	28,800	21,600	57,600	
12"	TT1-912	19,200		38,400	TT2-912	28,800		57,600	
12"	EE1-912-T3	19,200	14,400	38,400	EE2-912-T3	28,800	21,600	57,600	
12"	EE1-912-T4	19,200	14,400	38,400	EE2-912-T4	28,000	21,600	57,600	
12"	EN1-912	28,200	22,550	56,400	EN2-912	50,000	40,000	100,000	

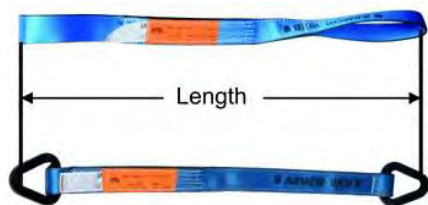

TYPE 1 - CT    TYPE 2 - TT    TYPE 3 - EE    TYPE 4 - EE    TYPE 5 - EN

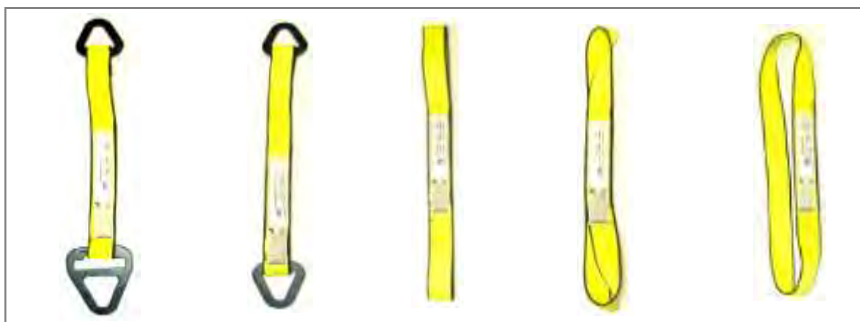

## POLYESTER SLINGS

LIST PRICE, EFFECTIVE SEPTEMBER 2020					
ITEM #	THICKNES	WIDTH /in.	TYPE 3	TYPE 4	LENGTH /ft.
650254	EE1	90-1	T3		2
650256	EE2	90-1	T3		2
650220	EE1	90-1		T4	3
650859	EE2	90-1		T4	3
650255	EE1	90-1	T3		3
650223	EE2	90-1	T3		3
650225	EE2	90-1		T4	4
650222	EE1	90-1	T3		5
650232	EE2	90-1	T3		6
650235	EE2	90-1		T4	6
650233	EE2	90-1	T3		8
650236	EE2	90-1		T4	8
650244	EE2	90-1	T3		10
650245	EE2	90-1		T4	10
650227	EE2	90-2	T3		4
650230	EE2	90-2	T3		6
650237	EE2	90-2		T4	6
650241	EE2	90-2	T3		8
650240	EE2	90-2		T4	8
650246	EE2	90-2	T3		10
650247	EE2	90-2		T4	10
650248	EE2	90-2	T3		12
650249	EE2	90-2		T4	12
650251	EE2	90-2	T3		6
650231	EE2	90-2		T4	6
650250	EE2	90-2	T3		8
650252	EE2	90-2		T4	10



OTHER SIZES AND TYPES  
AVAILABLE UPON REQUEST  
**CALL FOR PRICING**

## ROUND SLINGS

LIST PRICE, EFFECTIVE SEPTEMBER 2020				
CODE #	COLOUR	VERTICAL /LB.	CHOKER /LB.	BASKET /LB. 3 FT.
SL-30	Purple	3,000	2,400	6,000
SL-40	Black	4,000	3,200	8,000
SL-60	Green	6,000	4,800	12,000
SL-90	Yellow	9,000	7,200	18,000
SL-120	Tan	12,000	9,600	24,000
SL-140	Red	14,000	11,200	28,000
SL-170	Orange	17,000	13,600	34,000
SL-230	Blue	23,000	18,400	46,000
SL-260	Orange	26,000	20,800	52,000
SL-320	Gray	32,000	25,600	64,000
SL-400	Orange	40,000	32,000	80,000
SL-540	Orange	54,000	43,200	108,000
SL-680	Orange	68,000	54,400	136,000
SL-900	Orange	90,000	72,000	180,000

## WIRE MESH SLINGS - SPECIFICATIONS

Mesh Width in inches	Terminal Measurements Dimensions in inches				Terminal Thick.in inches		3 Ft. Sling Wt. In lb.			Wt. Per ft. in lb.			Mesh Weight
	MW	D	IL	TL	CL	10	12/14Ga	10Ga	12Ga	14Ga	10Ga	12Ga	
2	2-1/4	3-1/4	4-3/4	6-1/2	1/2	3/8	5	4	4	1.3	1.1	0.	
3	2-3/4	3-5/8	5-3/8	7-1/4	1/2	3/8	8	6	5	1.9	1.8	1.	
4	3	4	6	7-3/4	1/2	3/8	10	9	7	2.5	2.3	1.	
6	3-3/8	4-3/8	6-1/2	8-3/4	1/2	3/8	16	12	10	3.9	3.4	2.	
8	4-1/2	5-7/8	8-1/2	10-1/4	1/2	3/8	22	17	15	5.1	4.5	3.	
10	4-3/4	6-1/8	9-1/8	12-3/8	1/2	3/8	29	23	20	6.4	5.6	3.	
12	5	6-1/2	9-1/2	13	1/2	3/8	33	27	23	7.6	6.8	4.	
14	5-1/4	7	10-1/8	14-1/4	1/2	3/8	43	34	31	8.9	7.9	5.	
16	5-1/2	7-1/8	11-1/2	16-1/4	1/2	3/8	53	41	38	10.1	9.0	6.	
18	5-3/4	7-5/8	12-1/2	18	1/2	3/8	61	47	44	11.4	10.1	6.	
20	6	8	13-1/2	19-1/4	1/2	3/8	67	52	49	12.8	11.3	7.	

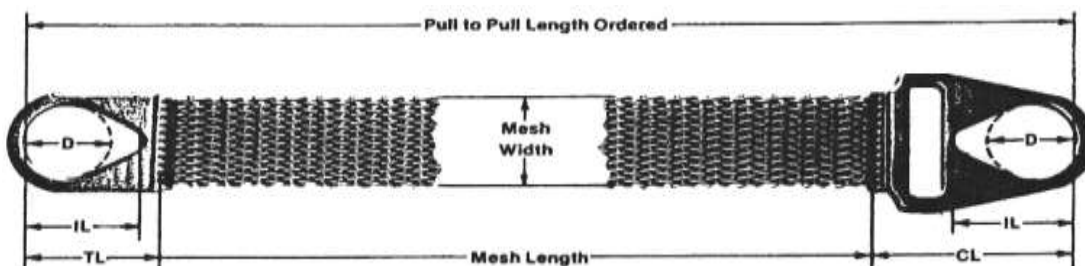
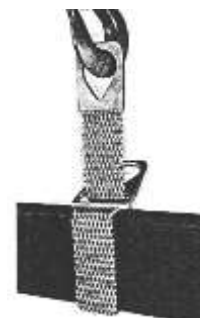

## RATED CAPACITY IN LBS.

	WIRE MESH		
	WIDTH/IN.	CHOKER	BASKET
<b>10 Gage</b>	2	2,300	4,600
	3	3,500	7,000
	4	4,800	9,600
	6	7,200	14,400
	8	9,600	19,200
	10	12,000	24,000
	12	14,400	28,800
	14	16,800	33,600
	16	19,200	38,400
	18	21,600	43,200
<b>12 Gage</b>	2	1,600	3,200
	3	2,400	4,800
	4	3,200	6,400
	6	4,800	9,600
	8	6,400	12,800
	10	8,000	16,000
<b>14 Gage</b>	2	900	1,800
	3	1,500	3,000
	4	2,000	4,000
	6	3,000	6,000
	8	4,000	8,000
	10	5,000	10,000
	12	6,000	12,000

**WARNING** Do not exceed rated capacities

### HOW TO ORDER

#### WIRE MESH SLINGS

1. Specify Pull to Pull length.
2. Specify mesh width in inches
3. Specify mesh 10,12, or 14 gauge.
4. Specify sling type 1 or 2

#### TYPE 1 CHOKER SLING



#### TYPE 2 BASKET SLING



IF SIDES OF BASKET ARE NOT 90° VERTICAL, THE RATED CAPACITY MUST BE REDUCED AS FOLLOWS

#### Sling

Angle	Loss Factor
75°.	.9659
60°.	.8660
45°.	.7071
30°.	.5000

**It is not recommended** that slings be used at smaller angle than 30 degrees. PRICES AVAILABLE ON REQUEST



10 Gage Heavy Duty



12 Gage Medium Duty



14 Gage Light Duty

# WALCO CARGO CONTROL COMPONENTS

<b>WINCHES</b>	H.D. Small Frame -----Page 1	<b>ACCESSORIES</b>	Ratchet Buckles -----Page 11
	Portable -----Page 1		End Fittings & Hooks -----Page 12
	Loose Frame -----Page 1		Rope Tie Off -----Page 12
	Weld-on -----Page 1		Snap Hook -----Page 12
	Low Profile -----Page 1		D Ring -----Page 12
	Three Bar -----Page 1		J hook -----Page 12
	Slider Weld-on -----Page 1		Wire Hook -----Page 12
	Lashing Winch -----Page 2		Flat Hook -----Page 12
	Web Winder -----Page 2		Delta Ring -----Page 12
	Winch Track -----Page 2		Chain end w/ Hook -----Page 12
<b>FLATBED ACCESSORIES</b>			Pan Fittings -----Page 12
	Winch Bars -----Page 2		Door Pull Straps -----Page 12
	5 <sup>th</sup> Wheel Puller -----Page 2		Floor Chain Tie Down -----Page 12
	Rubber Tarp Ties -----Page 2		Beam Socket -----Page 12
	S Hooks -----Page 2		Logistic Track -----Page 13
	Corner Protectors -----Page 2		Decking Beams -----Page 13
	Wear Sleeves -----Page 2		Beam Heads & Pins -----Page 13
	Wheel Chocks -----Page 2		Cargo Stays & Parts -----Page 13
	Weld-on D rings -----Page 2		Shoring Bars -----Page 13
<b>WINCH STRAPS</b>			Jack Bar -----Page 13
	2" 3" Widths -----Page 3		Cargo Hoops -----Page 13
	4" Width -----Page 4		Cargo Nets -----Page 13
<b>RATCHET STRAP ASSEMBLIES</b>		<b>LOGISTIC STRAPS 2"</b> -----Page 14	
	2" 3" 4" Widths -----Page 5 & 6	<b>UTILITY RATCHET STRAPS 1"</b> -----Page 14	
<b>SLINGS &amp; ACCESSORIES</b>		<b>TIE DOWNS 1"</b>	
	Wheel Tie Downs -----Page 7		Cargo Straps Packaged -----Page 15
	Towing Straps -----Page 7		Cargo Straps Display Stand -----Page 16
	Round Slings -----Page 7		
<b>TRUCK LADDER</b>	-----Page 7	<b>TIRE CHAIN AND ACCESSORIES</b> -----Page 17	
<b>WEB SLINGS</b>	-----Page 8		Truck -----
<b>LOAD BINDERS</b>	-----Page 9		Fork Lift -----
	Binder Locks -----Page 9		ATV -----
<b>WIRE ROPE ASSEMBLIES</b>	-----Page 9		Side Chain -----
	Wire Rope Clips -----Page 9		Cross chain -----
	Wire Rope Thimbles -----Page 9		Studded chain -----
	Swage Sleeve -----Page 9		Cross chin hooks -----
<b>CHAIN ASSEMBLIES</b>			Repair Links -----
	Bulk Chain -----Page 10		Quick Links -----
	Chain Assemblies -----Page 10		Tire chain Locks -----
<b>ACCESSORIES</b>			
	Hooks – Grab & Slip ----Page 10		
	Double Clevis Link -----Page 10		
	Mid Link -----Page 10		
	Anchor Shackles -----Page 11		
	Eye Bolts -----Page 11		





# FLATBED PRODUCTS

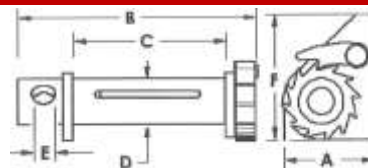

## WINCHES

### H.D. WELD-ON SHORT SLIDER

BLACK/ZINC



	A	B	C	D	E	F
	6-3/4"	7-3/4"	4-5/8"	1-7/8"	31/32"	3-7/8"
ITEM #				W.L.L.	WEIGHT	
649313	Solid Barrel Winch w/ washer - Black			6,000 lb./2,727 kg.	11 lb.	
649315	Solid Barrel Winch no washer - Black			6,000 lb./2,727 kg.		
649373	Solid Barrel Winch w/ washer - Zinc			6,000 lb./2,727 kg.		
649375	Solid Barrel Winch no washer - Zinc			6,000 lb./2,727 kg.		

### LONG FRAME H.D. SLIDER



	A	B	C	D	E	F
	6-3/4"	10-3/8"	7-1/4"	1-7/8"	31/32"	3-7/8"
ITEM #				W.L.L.	WEIGHT	
649314	Solid Barrel Winch no washer - Black			6,000 lb./2,727 kg.	13 lb.	
649374	Solid Barrel Winch no washer - Zinc			6,000 lb./2,727 kg.		
649382	Solid Barrel Winch w/ washer - Zinc			6,000 lb./2,727 kg.		

### PORTABLE LOW PROFILE

STANDARD



	A	B	C	D	E	F
	5"	7-3/4"	4-5/8"	1-7/8"	31/32"	3-7/8"
ITEM #				W.L.L.	WEIGHT	
649324	Low Profile - with set-screw			6,000 lb./2,727 kg.	9 lb.	
649360	Standard - with set screw			6,000 lb./2,727 kg.	10 lb.	

### LOOSE FRAME LOW PROFILE



	A	B	C	D	E	F
	4"	7-1/2"	4-5/8"	1-7/8"	31/32"	5"
ITEM #				W.L.L.	WEIGHT	
649325	Loose Frame Weld-On			6,000 lb./2,727 kg.	6-1/4 lb.	

### STANDARD WELD-ON



	A	B	C	D	E	F
	5-1/2"	8"	4-5/8"	1-7/8"	31/32"	3-7/8"
ITEM #				W.L.L.	WEIGHT	
649327	Standard Weld-On Winch			6,000 lb./2,727 kg.	8 lb.	

### LOW PROFILE WELD-ON

SLIDE-ON



	A	B	C	D	E	F
	4-1/2"	8"	4-5/8"	1-7/8"	31/32"	3-7/8"
ITEM #				W.L.L.	WEIGHT	
649326	Low profile Weld-on			6,000 lbs./2,727 kg.	8 lb.	
649328	3.94"	8"	4.86"	1-7/8"	31/32"	6"
	Low Profile Slider			6,000 lbs./2,727 kg		

### THREE BAR WELD-ON

BOTTOM MOUNT



	A	B	C	D	E	F
	4"	10"	6-1/2"	2-3/8"	31/32"	3-7/8"
ITEM #				W.L.L.	WEIGHT	
649350	Side Mount - Weld-on - Painted			6,000 lb./2,727 kg.	12 lb.	
649351	Side Mount - Weld-on - Primed			6,000 lb./2,727 kg.	12 lb.	
649355	5-1/2"	10"	6-1/2"	2-3/8"	31/32"	3-7/8"
	Low profile - Bottom Mount			6,000 lb./2,727 kg.		

	A	B	C	D	E	F
--	---	---	---	---	---	---



## LASHING WINCH

ITEM #	BREAKING STRENGTH	W.L.L.	WEIGHT
649312	10,000 lb.	3,300 lb./ 1,510 kg.	3 lb.

This versatile tie-down has features of both a Winch and a Ratchet Buckle. It can be welded or bolted in place like a winch, but offers the quick release and easy operation of a ratchet buckle.

Uses a 1-1/8" socket. Drive (not included) Will accept up to 2" webbing

## WEB WINDER - PORTABLE

ITEM #	WEIGHT
649301	3 lb.

Attach to truck rails. Dismount for storage. Wind 2, 3, & 4" webbing for compact storage

## WINCH TRACK

ITEM #	WEIGHT
649305	38.5 lb.

**H.D. Steel Track**, designed for use with sliding winches. Available in standard 6-foot lengths.

## WINCH BARS

ITEM #	
649306	Heavy Duty black painted winch bar. Weight - 4.25 lb. / 1.93 kg.
649308	Heavy Duty chrome winch bar. Weight - 4.75 lb. / 2.16 kg.
649309	Heavy Duty chrome combination winch bar. Heat treated, durable tapered nose. Length 35". Weight - 5.7 lb. / 2.59 kg.



## 5th WHEEL PULLER

ITEM #	LENGTH	WEIGHT
649300	28" Chrome	1.8 lb. / .82 kg.



## RUBBER TARP TIES with HOOKS

ITEM #	LENGTH	WEIGHT /100
649602	9"	9.2 lb. / 4.18 kg.
649603	15"	11.5 lb. / 5.23 kg.
649604	21"	14.0 lb. / 6.36 kg.
649606	31"	17.5 lb. / 7.95 kg.
649607	41"	23.0 lb. / 10.45 kg.
649600	S Hooks for tarp ties	

**100 per case.** Made from ozone resistant and stretch resistant E.P.T. synthetic rubber.



## CORNER PROTECTORS

### PLASTIC 12" PROTECTORS



ITEM # 649462

Durable polyethylene corners protect tie down straps from damage and are required by law when road conditions could cause damage to tie down straps.

### PLASTIC PROTECTORS



2" to 4" WEBBING  
Weight .02 lb.  
ITEM # 649460

### STEEL PROTECTORS



2" WEBBING, CABLE, CHAIN  
Weight 1.3 lb.  
ITEM # 649329



2" - 4" WEBBING  
Weight 1.7 lb.  
ITEM # 649331

## WEAR SLEEVE



Protects straps from cuts and abrasions.  
Wear sleeves sold per foot.

ITEM # 649105	for 2" strap
ITEM # 649106	for 3" strap
ITEM # 649097	for 4" strap
ITEM # 649107	Velcro, for 3"

## WHEEL CHOCKS



ITEM #	DESCRIPTION
ITEM 649610	"A" PYRAMID
	• Durable rubber triangle
	• Maximum traction.
	• Reliable even on ice or snow.
	• Will not gouge tires, even if they are run over.
ITEM 649611	"B" CONTOUR

## D-RING - with weld-on mounting bracket Self Colour



ITEM #	SIZE	BREAKING STRENGTH
649626	1/2"	12,000 lb./ 5,454 kg.
649632	5/8"	18,390 lb./ 8,454 kg.
649636	3/4"	26,500 lb./12,045 kg.
649638	1" Long	46,760 lb./21,254 kg.
649646	1" Short	" "
649645	1" Long Bent	" "

# FLATBED PRODUCTS

## 2" WINCH STRAP



ITEM #	LENGTH	WIRE HOOK	BREAKING STRENGTH	W.L.L.	CALIFORNIA RATING
649023	20'	1/2"	10,000 lb./ 4,545 kg.	3,300 lb./1,515 kg.	6,000 lb.
649026	25'	1/2"	10,000 lb./ 4,545 kg.	3,300 lb./1,515 kg.	6,000 lb.
649027	30'	1/2"	10,000 lb./ 4,545 kg.	3,300 lb./1,515 kg.	6,000 lb.
	20'	3/8"	10,000 lb./ 4,545 kg.	3,300 lb./1,515 kg.	6,000 lb.
	25'	3/8"	10,000 lb./ 4,545 kg.	3,300 lb./1,515 kg.	6,000 lb.
	30'	3/8"	10,000 lb./ 4,545 kg.	3,300 lb./1,515 kg.	6,000 lb.



ITEM #	LENGTH	FLAT HOOK	BREAKING STRENGTH	W.L.L.	CALIFORNIA RATING
649036	25'		10,000 lb./ 4,545 kg.	3,300 lb./1,515 kg.	6,000 lb.
649037	30'		10,000 lb./ 4,545 kg.	3,300 lb./1,515 kg.	6,000 lb.



ITEM #	LENGTH	DELTA RING	BREAKING STRENGTH	W.L.L.	CALIFORNIA RATING
649056	25'		10,000 lb./ 4,545 kg.	3,300 lbs./1,515 kg.	6,000 lb.
649057	30'		10,000 lb./ 4,545 kg.	3,300 lbs./1,515 kg.	6,000 lb.



ITEM #	LENGTH	SNAP HOOK	BREAKING STRENGTH	W.L.L.	CALIFORNIA RATING
649063	15'		10,000 lb./ 4,545 kg.	3,300 lb./1,515 kg.	6,000 lb.
649062	20'		10,000 lb./ 4,545 kg.	3,300 lb./1,515 kg.	6,000 lb.
649066	25'		10,000 lb./ 4,545 kg.	3,300 lb./1,515 kg.	6,000 lb.
649061	30'		10,000 lb./ 4,545 kg.	3,300 lb./1,515 kg.	6,000 lb.



ITEM #	LENGTH	CHAIN & GRAB	BREAKING STRENGTH	W.L.L.	CALIFORNIA RATING
649046	25'	5/16"	10,000 lb./ 4,545 kg.	3,300 lb./1,515 kg.	6,000 lb.
649047	30'		10,000 lb./ 4,545 kg.	3,300 lb./1,515 kg.	6,000 lb.

## 3" WINCH STRAP



ITEM #	LENGTH	WIRE HOOK	BREAKING STRENGTH	W.L.L.	CALIFORNIA RATING
649100	25'	5/8"	15,000 lb./ 6,818 kg.	5,000 lb./2,272 kg.	9,000 lb.
649102	30'		15,000 lb./ 6,818 kg.	5,000 lb./2,272 kg.	9,000 lb.



ITEM #	LENGTH	FLAT HOOK	BREAKING STRENGTH	W.L.L.	CALIFORNIA RATING
649110	25'		16,200 lb./ 6,818 kg.	5,400 lb./2,272 kg.	9,000 lb.
649112	30'		16,200 lb./ 6,818 kg.	5,400 lb./2,272 kg.	9,000 lb.



ITEM #	LENGTH	DELTA RING	BREAKING STRENGTH	W.L.L.	CALIFORNIA RATING
649130	30'		15,000 lb./ 6,818 kg.	5,000 lb./2,272 kg.	9,000 lb.



ITEM #	LENGTH	CHAIN & HOOK	BREAKING STRENGTH	W.L.L.	CALIFORNIA RATING
649120	25'	5/16"	15,000 lb./ 6,818 kg.	5,000 lb./2,272 kg.	9,000 lb.
649117	30'	5/16"	15,000 lb./ 6,818 kg.	5,000 lb./2,272 kg.	9,000 lb.
649124	40'	5/16"	15,000 lb./ 6,818 kg.	5,000 lb./2,272 kg.	9,000 lb.
649135	30'	3/8"	18,000 lb./8,181 kg.	6,000 lb./2,272 kg.	12,000 lb.
649133	30'	3/8" Grade 40	16,400 lb./7,439 kg.	5,400 lb./2,449 kg.	

WORKING TOGETHER TO ENSURE A STRONG FUTURE

# FLATBED PRODUCTS

## 4" WINCH STRAP

ITEM #	LENGTH	WIRE HOOK	BREAKING STRENGTH	W.L.L.	CALIFORNIA RATING
649199	30'	5/8"	20,000 lb./9,090 kg.	6,600 lb./3,000 kg.	12,000 lb.



ITEM #	LENGTH	FLAT HOOK	BREAKING STRENGTH	W.L.L.	CALIFORNIA RATING
649200	25'		20,000 lb./9,090 kg.	6,600 lb./3,000 kg.	12,000 lb.
649202	30'		20,000 lb./9,090 kg.	6,600 lb./3,000 kg.	12,000 lb.



ITEM #	LENGTH	DELTA RING	BREAKING STRENGTH	W.L.L.	CALIFORNIA RATING
649230	40'		20,000 lb./9,090 kg.	6,600 lb./3,000 kg.	12,000 lb.
649232	30'		20,000 lb./9,090 kg.	6,600 lb./3,000 kg.	12,000 lb.



ITEM #	LENGTH	CHAIN & HOOK	BREAKING STRENGTH	W.L.L.	CALIFORNIA RATING
649220	25'	3/8"	20,000 lb./9,090 kg.	6,000 lb./3,000kg.	12,000 lb.
649222	30'		20,000 lb./9,090 kg.	6,000 lb./3,000 kg.	12,000 lb.



ITEM #	LENGTH	LOOP	BREAKING STRENGTH	W.L.L.	CALIFORNIA RATING
	30'		18,000 lb./8,181 kg.	6,000 lb./2,727 kg.	12,000 lb.



ITEM #	LENGTH	GRAB HOOK	BREAKING STRENGTH	W.L.L.	CALIFORNIA RATING
649242	30'		16,200 lb./7,363 kg.	5,400 lb./2,454 kg.	



**2" RATCHET ASSEMBLY WITH LONG WIDE HANDLE**



COMPLETE RATCHET ASSEMBLY 2" X 27' AS SHOWN ABOVE

ITEM #	LENGTH	HOOK	BREAKING STRENGTH	W.L.L.
649075	27'	1/2" Wire Hooks	10,000 lb./4,545 kg.	3,300 lb./1,515 kg.
649077	27'	Flat Hooks	10,000 lb./4,545 kg.	3,300 lb./1,515 kg.
649079	27'	Chain End	10,000 lb./4,545 kg.	3,300 lb./1,515 kg.

WIRE HOOK



FLAT HOOK



DELTA RING



SNAP HOOK



CHAIN END



COMPLETE ITEM #	STRAP ONLY ITEM #	RATCHET W/TAIL ITEM #	LENGTH	HOOK	BREAKING STRENGTH	W.L.L.
649820	649023	649025	20'	1/2" Wire	10,000 lb./4,545 kg.	3,300 lb./1,515 kg.
649028	649026	649025	25'	1/2" Wire	10,000 lb./4,545 kg.	3,300 lb./1,515 kg.
649070	649027	649025	30'	1/2" Wire	10,000 lb./4,545 kg.	3,300 lb./1,515 kg.
649828	649850	649850	20'	3/8" Wire	5,000 lb./ 2,272 kg.	1,666 lb. / 757 kg.
649072	649787	649850	25'	3/8" Wire	5,000 lb./ 2,272 kg.	1,666 lb. / 757 kg.
649039	649789	649850	30'	3/8" Wire	5,000 lb./ 2,272 kg.	1,666 lb. / 757 kg.
649821	649036	649035	20'	Flat	10,000 lb./4,545 kg.	3,300 lb./1,515 kg.
649822	649037	649035	25'	Flat	10,000 lb./4,545 kg.	3,300 lb./1,515 kg.
		649055	30'	Flat	10,000 lb./4,545 kg.	3,300 lb./1,515 kg.
	649056	649055	20'	Delta Ring	10,000 lb./4,545 kg.	3,300 lb./1,515 kg.
	649057	649055	25'	Delta Ring	10,000 lb./4,545 kg.	3,300 lb./1,515 kg.
	649062	649060	30'	Delta Ring	10,000 lb./4,545 kg.	3,300 lb./1,515 kg.
	649066	649060	20'	Snap	10,000 lb./4,545 kg.	3,300 lb./1,515 kg.
649825	649061	649060	25'	Snap	10,000 lb./4,545 kg.	3,300 lb./1,515 kg.
649823	649046	649045	30'	Snap	10,000 lb./4,545 kg.	3,300 lb./1,515 kg.
649824	649047	649045	25'	Chain End	10,000 lb./4,545 kg.	3,300 lb./1,515 kg.
		649045	30'	Chain End	10,000 lb./4,545 kg.	3,300 lb./1,515 kg.

**2" RATCHET ASSEMBLY WITH SHORT WIDE HANDLE**



COMPLETE ITEM #	STRAP ONLY ITEM #	RATCHET W/TAIL ITEM #	LENGTH	HOOK	BREAKING STRENGTH	W.L.L.
649759	649023	649795	20'	1/2" Wire	10,000 lb./4,545 kg.	3,300 lb./1,515 kg.
649760	649026	649795	25'	1/2" Wire	10,000 lb./4,545 kg.	3,300 lb./1,515 kg.
649762	649027	649795	30'	1/2" Wire	10,000 lb./4,545 kg.	3,300 lb./1,515 kg.
649793	649787	649763	20'	3/8" Wire	5,000 lb. / 2,272 kg.	1,666 lb./1,515 kg.
	649789	649763	25'	3/8" Wire	5,000 lb. / 2,272 kg.	1,666 lb./1,515 kg.
	649039	649763	30'	3/8" Wire	5,000 lb. / 2,272 kg.	1,666 lb./1,515 kg.
	649036		20'	Flat	10,000 lb./4,545 kg.	3,300 lb./1,515 kg.
	649037		25'	Flat	10,000 lb./4,545 kg.	3,300 lb./1,515 kg.
			30'	Flat	10,000 lb./4,545 kg.	3,300 lb./1,515 kg.
	649056		20'	Delta Ring	10,000 lb./4,545 kg.	3,300 lb./1,515 kg.
	649057		25'	Delta Ring	10,000 lb./4,545 kg.	3,300 lb./1,515 kg.
	649062		30'	Delta Ring	10,000 lb./4,545 kg.	3,300 lb./1,515 kg.
	649066		20'	Snap	10,000 lb./4,545 kg.	3,300 lb./1,515 kg.
	649061		25'	Snap	10,000 lb./4,545 kg.	3,300 lb./1,515 kg.
	649046		30'	Snap	10,000 lb./4,545 kg.	3,300 lb./1,515 kg.
649792	649047		25'	Chain End	10,000 lb./4,545 kg.	3,300 lb./1,515 kg.
			30'	Chain End	10,000 lb./4,545 kg.	3,300 lb./1,515 kg.

**WORKING TOGETHER TO ENSURE A STRONG FUTURE**

# FLATBED PRODUCTS



## 2" RATCHET ASSEMBLY SHORT NARROW HANDLE

COMPLETE ASSEMBLY ITEM #	STRAP ONLY ITEM #	RATCHET W/TAIL ITEM #	LENGTH	HOOK	BREAKING STRENGTH	W.L.L.
	649023	649018	20'	1/2" Wire	10,000 lb./4,545 kg.	3,300 lb./ 4,545 kg.
	649026	649018	25'	1/2" Wire	10,000 lb./4,545 kg.	3,300 lb./ 4,545 kg.
	649027	649018	30'	1/2" Wire	10,000 lb./4,545 kg.	3,300 lb./ 4,545 kg.
	649788		20'	3/8" Wire	5,000 lb. /2,272 kg.	1,600 lb./ 757 kg.
649029	649787	649788	25'	3/8" Wire	5,000 lb. /2,272 kg.	1,600 lb./ 757 kg.
649791	649789	649788	30'	3/8" Wire	5,000 lb. /2,272 kg.	1,600 lb./ 757 kg.
	649039	649040	20'	Flat	10,000 lb./4,545 kg.	3,300 lb./4,545 kg.
	649036	649040	25'	Flat	10,000 lb./4,545 kg.	3,300 lb./4,545 kg.
	649037	649040	30'	Flat	10,000 lb./4,545 kg.	3,300 lb./4,545 kg.
			20'	Delta Ring	10,000 lb./4,545 kg.	3,300 lb./4,545 kg.
	649056		25'	Delta Ring	10,000 lb./4,545 kg.	3,300 lb./4,545 kg.
	649057		30'	Delta Ring	10,000 lb./4,545 kg.	3,300 lb./4,545 kg.
	649046		25'	Chain End	10,000 lb./4,545 kg.	3,300 lb./4,545 kg.
	649047		30'	Chain End	10,000 lb./4,545 kg.	3,300 lb./4,545 kg.



## 3" RATCHET ASSEMBLY WITH LONG WIDE HANDLE

COMPLETE ASSEMBLY ITEM #	STRAP ONLY ITEM #	RATCHET W/TAIL ITEM #	LENGTH	HOOK	BREAKING STRENGTH	W.L.L.
	649100	649099	25'	Grab Hook	15,000 lb./6,818 kg.	5,000 lb./2,272 kg.
			30'	Grab Hook	15,000 lb./6,818 kg.	5,000 lb./2,272 kg.
649127	649120	649121	25'	Chain End	15,000 lb./6,818 kg.	5,000 lb./2,272 kg.
	649122	649099	30'	1/2" Wire	15,000 lb./6,818 kg.	5,000 lb./2,272 kg.
	649102	649099	30'	1/2" Wire	15,000 lb./6,818 kg.	5,000 lb./2,272 kg.
	649110	649111	25'	Flat	16,200 lb./6,818 kg.	5,400 lb./2,272 kg.
649826	649112	649111	30'	Flat	16,200 lb./6,818 kg.	5,400 lb./2,272 kg.
			25'	Delta Ring	15,000 lb./6,818 kg.	5,000 lb./2,272 kg.
	649130		30'	Delta Ring	15,000 lb./6,818 kg.	5,000 lb./2,272 kg.
			25'	Snap Hook	15,000 lb./6,818 kg.	5,000 lb./2,272 kg.
			30'	Snap Hook	15,000 lb./6,818 kg.	5,000 lb./2,272 kg.



## 4" RATCHET ASSEMBLY WITH LONG WIDE HANDLE

COMPLETE ASSEMBLY ITEM #	STRAP ONLY ITEM #	RATCHET W/TAIL ITEM #	LENGTH	HOOK	BREAKING STRENGTH	W.L.L.
	649200	649201	25'	Flat	20,000 lb./9,090 kg.	6,600 lb./3,000 kg.
649829	649202	649201	30'	Flat	20,000 lb./9,090 kg.	6,600 lb./3,000 kg.
			25'	Delta Ring	20,000 lb./9,090 kg.	6,600 lb./9,090 kg.
	649232		30'	Delta Ring	20,000 lb./9,090 kg.	6,600 lb./3,000 kg.
	649220	649221	25'	Chain End	20,000 lb./9,090 kg.	6,600 lb./9,090 kg.
649830	649222	649221	30'	Chain End	20,000 lb./9,090 kg.	6,600 lb./3,000 kg.

# FLATBED PRODUCTS



## ADJUSTABLE WHEEL TIE-DOWNS

ITEM #	W.L.L.	TIRE SIZE	BREAK STRENGTH
649854	1,666 lb.	15 - 16"	5,000 lb.
649855	754 kg	13 - 14"	2,272 kg

This wheel harness allows you to safely haul a wide variety of vehicles.



## TOWING STRAPS

ITEM	SIZE	W.L.L.
649091	2" x 20'	
649092		3" x 20'
649093	4" x 20'	
649094		4" x 30'

Single ply towing strap with twisted eye and eye.



## ROUND SLING

CODE #	COLOUR	VERTICAL	CHOKER	BASKET
SL-30	Purple	3,000 lb.	2,400 lb.	6,000
SL-40	Black	4,000	3,200	8,000
SL-60	Green lbs.	6,000 lb.	4,800 lb.	12,000
SL-90	Yellow	9,000	7,200	18,000
SL-120	Tan	12,000	9,600	24,000
SL-1430	Red	14,000 lb.	11,200 lb.	28,000
SL-170	Orange	17,000	13,600	34,000
SL-230	Blue	23,000	18,400	46,000
SL-260	Orange	26,000	20,800	52,000
SL-320	Grey	32,000 lb.	25,600 lb.	64,000
SL-400	Orange	40,000	32,000	80,000
SL-540	Orange	54,000	43,200	108,000
SL-680	Orange	68,000	54,400	136,000
SL-900	Orange	90,000	72,000	180,000

Constructed from a multiple of high tenacity polyester yarns in an endless loop, covered with a woven polyester jacket. Hook and load points can be rotated to extend the life of the sling. Polyester cover protects the inner fibres from wear, and the load from sling damage, reducing the need for wear pads.

# SLING ACCESSORIES

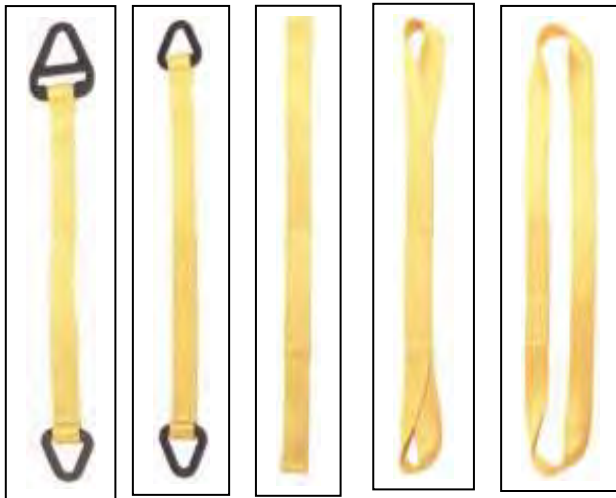

TYPE 1 TC      TYPE 2 TT      TYPE 3 EE      TYPE 4 EE      TYPE 5 EN

## WEB SLINGS



VERTICAL      CHOKER      BASKET

### SINGLE PLY

### DOUBLE PLY

WIDTH	REFERENCE #	VERTICAL	CHOKER	BASKET	REFERENCE #	VERTICAL	CHOKER	BASKET
1"	EE1-901-T3	1600	1280	3200	EE2-901-T3	3100	2400	6400
1"	EE1-901-T4	1600	1280	3200	EE2-901-T4	3100	2400	6400
1"	EN1-901	3200	2560	6400	EN2-901	6200	4960	12,400
2"	TC1-902	3100	2480	6200	TC2-902	6200	4960	12,400
2"	TT1-902	3100		6200	TT2-902	6200		12,400
2"	EE1-902-T3	3100	2480	6200	EE2-902-T3	6200	4960	12,400
2"	EE1-902-T4	3100	2480	6200	EE2-902-T4	6200	4960	12,400
2"	EN1-902	6200	4960	12,400	EN2-902	12,400	9920	24,800
3"	TC1-903	4700	3760	9400	TC2-903	8800	7040	17,600
3"	TT1-903	4700		9400	TT2-903	8800		17,600
3"	EE1-903-T3	4700	3760	9400	EE2-903-T3	8800	7040	17,600
3"	EE1-903-T4	4700	3760	9400	EE2-903-T4	8800	7040	17,600
3"	EN1-903	9400	7520	18,800	EN2-903	17,600	14,080	35,200
4"	TC1-904	6200	4960	11,400	TC2-904	11,000	8800	22,000
4"	TT1-904	6200		11,400	TT2-904	11,000		22,000
4"	EE1-904-T3	6200	4960	11,400	EE2-904-T3	11,000	8800	22,000
4"	EE1-904-T4	6200	4960	11,400	EE2-904-T4	11,000	8800	22,000
4"	EN1-904	12,400	9920	24,800	EN2-904	22,000	17,600	44,000
5"	TC1-905	7800	6240	16,000	TC2-905	13,700	10,300	27,400
5"	TT1-905	7800		16,000	TT2-905	13,700		27,400
5"	EE1-905-T3	7800	6240	16,000	EE2-905-T3	13,700	10,300	27,400
5"	EE1-905-T4	7800	6240	16,000	EE2-905-T4	13,700	10,300	27,400
5"	EN1-905	15,000	12,000	30,000	EN2-905	27,500	22,000	55,000
6"	TC1-906	9300	7440	18,600	TC2-906	16,500	13,200	33,000
6"	TT1-906	9300		18,600	TT2-906	16,500		33,000
6"	EE1-906-T3	9300	7440	18,600	EE2-906-T3	16,500	13,200	33,000
6"	EE1-906-T4	9300	7440	18,600	EE2-906-T4	16,500	13,200	33,000
6"	EN1-906	18,600	14,880	37,200	EN2-906	33,000	26,400	66,000
8"	TC1-908	11,750	9400	23,500	TC2-908	22,750	18,200	45,500
8"	TT1-908	11,750		23,500	TT2-908	22,750		45,500
8"	EE1-908-T3	11,750	9400	23,500	EE2-908-T3	22,750	18,200	45,500
8"	EE1-908-T4	11,750	9400	23,500	EE2-908-T4	22,750	18,200	45,500
8"	EN1-908	21,150	16,920	42,300	EN2-908	42,350	33,880	84,700
10"	TC1-910	14,700	11,760	29,400	TC2-910	28,400	22,720	46,800
10"	TT1-910	14,700		29,400	TT2-910	28,400		46,800
10"	EE1-910-T3	14,700	11,760	29,400	EE2-910-T3	28,400	22,720	46,800
10"	EE1-910-T4	14,700	11,760	29,400	EE2-910-T4	28,400	22,720	46,800
10"	EN1-910	26,450	21,160	52,900	EN2-910	52,900	42,320	105,800
12"	TC1-912	17,650	14,120	35,300	TC2-912	34,100	27,280	68,200
12"	TT1-912	17,650		35,300	TT2-912	34,100		68,200
12"	EE1-912-T3	17,650	14,120	35,300	EE2-912-T3	34,100	27,280	68,200
12"	EE1-912-T4	17,650	14,120	35,300	EE2-912-T4	34,100	27,280	68,200
12"	EN1-912	31,750	25,400	63,500	EN2-912	63,500	50,800	127,000

WORKING TOGETHER TO ENSURE A STRONG FUTURE



# FLATBED PRODUCTS

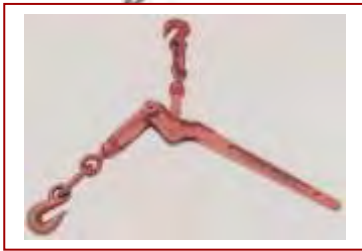

## BINDER LOCK (YELLOW)

### ITEM #

649635 A simple and effective way of keeping binders secure.

## STANDARD LOAD BINDER

ITEM #		W.L.L./LB.
604128	Standard Load Binder 1/4 – 5/16 Gr. 70	2600
604132	Standard Load Binder 5/16 – 3/8 Gr.70	6600
604140	Standard Load Binder 3/8 – 1/2 Gr.70	9200

Lever type binder with swivel hooks.  
Take up slack and apply tension to tie down system.  
Drop forged steel – Heat treated

## SAFETY LOAD BINDER

ITEM #		W.L.L./LB.
604160	Safety load binder 5/16 – 3/8 Gr. 70	5400

Special handle prevents finger trap  
and allows easy release.  
Drop forged steel – Heat treated

## RATCHET LOAD BINDER

ITEM #		W.L.L./LB.
604161	Ratchet load binder 5/16 – 3/8	5400
604162	Ratchet load binder 3/8 – 1/2	9200
604163	Ratchet load binder 1/2 - 5/8	13,000

No handle locking required.  
Short reach hooks provide optimum take up.  
Drop forged construction.

## WIRE ROPE ASSEMBLY ♦♦ WIRE ROPE AVAILABLE IN BULK ♦♦

ITEM #	WIRE SIZE		LENGTH	HOOK	W.L.L.
60508	1/4"	Stainless	30' 1	Grab w/Chain end	1,050 kg.
605510	1/4"	Galvanized	30' 1	Grab w/Chain end	1,050 kg.
605511	1/4"	Galvanized	32' 1	Grab w/Chain end	1,050 kg.
605514	5/16"	Galvanized	30' 1	Grab w/Chain end	1,500 kg.
605515	1/4"	Galvanized	30' 1	Grab w/Chain end	1,050 kg.

W.L.L. STAMPED ON FURREL. OTHER CONFIGURATIONS AVAILABLE.

## WIRE ROPE CLIP GALVANIZED MALLEABLE

ITEM #	CABLE DIAMETER	WEIGHT / 100
503419	3/16"	6 lb.
503420	1/4"	10 lb.
503421	5/16"	12 lb.
503422	3/8"	40 lb.

AVAILABLE IN "DROP FORGED"

## WIRE ROPE THIMBLE - ZINC

ITEM #	CABLE DIAMETER	WEIGHT / 100
604319	3/16	2.5 lb.
604320	1/4	2.5 lb.
604322	5/16	4.4 lb.
604324	3/8	7.6 lb.
604326	1/2"	AVAILABLE IN OTHER SIZES.

## SWAGE SLEEVES - ALUMINUM

ITEM #	CABLE DIAMETER	TYPE
604366	3/16	Oval
604364	3/16	Stop
604368	3/16	Spools
604369	1/4	Oval
604376	1/4	Stop
604370	5/16	Oval
604371	3/8	Oval

## BULK CHAIN GRADE 30 – HIGH TEST – SELF COLOUR

ITEM #	CHAIN SIZE	WIRE DIAMETER	INSIDE LK. LENGTH	INSIDE LK. WIDTH	DRUM QTY.	W.L.L.
600125	3/16"	.188	.98"	.41	1600'	600 lb.
600127	1/4"	.250	1.05"	.49"	900'	1050 lb.
600008	5/16"	.312	1.19"	.49"	550'	1700 lb.
600010	3/8"	.375	1.29"	.61"	400'	2400 lb.
600013	1/2"	.492	2.05"	.88"	250'	4150 lb.



GRADE 40 & BRIGHT ZINC AVAILABLE

## BULK CHAIN GRADE 70 - YELLOW DICHROMATE

ITEM #	CHAIN SIZE	WIRE DIAMETER	INSIDE LK. LENGTH	INSIDE LK. WIDTH	DRUM QTY.	W.L.L.
601027	1/4"	.281	.85"	.41"	800'	3,150 lb.
601028	5/16"	.343	.92"	.47"	550'	4,700 lb.
601029	3/8"	.394	1.15"	.57"	400'	6,600 lb.
601030	1/2"	.519	1.50"	.80"	98'	11,300 lb.
601032	5/8"	.618	2.23	.808"	100	15,800 lb.



High strength, lightweight chain, designed for the trucking industry. Embossed "W7"

## CHAIN ASSEMBLIES GRADE 70

ITEM #	SIZE	LENGTH	HOOKS	W.L.L.
601088	5/16"	16'	2 Grab Hooks	4,700 lb.
601089	5/16"	20'	2 Grab Hooks	4,700 lb.
601090	5/16"	25'	2 Grab Hooks	4,700 lb.
601105	3/8"	16'	2 Grab Hooks	6,600 lb.
601114	3/8"	20'	2 Grab Hooks	6,600 lb.
601113	3/8"	25'	2 Grab Hooks	6,600 lb.



OTHER SIZES AND HOOKS AVAILABLE

## CLEVIS GRAB HOOK GRADE 40 - CARBON STEEL

ITEM #	SIZE	WEIGHT PER 100	W.L.L.
604102	1/4"	43 lb.	2,600 lb.
604103	5/16"	73 lb.	3,900 lb.
604115	3/8"	121 lb.	5,400 lb.
604116	1/2"	220 lb.	9,200 lb.



## CLEVIS GRAB HOOK GRADE 70 - ALLOY STEEL

ITEM #	SIZE	WEIGHT PER 100	W.L.L.
604101	1/4"	43 lbs.	3,150 lb.
604168	5/16"	76 lbs.	4,700 lb.
604110	3/8"	121 lbs.	6,600 lb.
604114	1/2"	220 lbs.	11,300 lb.



## CLEVIS SLIP HOOK GRADE 70 - ALLOY STEEL

ITEM #	SIZE	WEIGHT PER 100	W.L.L.
604099	1/4"		2,750 lb.
604169	5/16"		4,300 lb.
604106	3/8"		5,250 lb.
604118	1/2"		9,200 lb.



## CLEVIS SLIP HOOK WITH LATCH GRADE 70

ITEM #	SIZE	WEIGHT
604060	1/4"	.60 lb.
604062	5/16"	.81 lb.
604064	3/8"	1.32 lb.
604066	1/2"	1.5 lb.
604012	5/8"	



## MID LINK GRADE 70 - ZINC PLATED

ITEM #	CHAIN END	LARGE END	WEIGHT PER 100	W.L.L.
604305	1/4	5/16	44 lb.	4,700
604308	5/16	3/8	87.5 lb.	6,600
604309	3/8	1/2	184 lb.	11,300



## DOUBLE CLEVIS LINK GRADE 70 - ZINC PLATED

ITEM #	LINK SIZE	WEIGHT PER 100	W.L.L.
604306	1/4 - 5/16	33 lb.	4,700
604310	3/8	45 lb.	6,600
604311	1/2	100 lb.	11,300



## ANCHOR SHACKLE SCREW PIN

ITEM #	SIZE	PIN SIZE	WEIGHT/100	W.L.L./TONS
604164	3/16	1/4	6 lb.	1/3
604208	1/4	5/16	12 lb.	1/2
604214	5/16	3/8	20 lb.	3/4
604210	3/8	7/16	30 lb.	1
604211	7/16	1/2	50 lb.	1-1/2
604213	1/2	5/8	75 lb.	2
604216	5/8	3/4	130 lb.	3-1/4
604219	3/4	7/8	225 lb.	4-3/5
604220	7/8	1"	350 lb.	6-1/2



Regular Eye Bolts Available  
1/2" - 5/8" - 3/4"  
8", 10" & 12" long

## EYE BOLTS SHOULDER TYPE

ITEM #	SIZE	TYPE	WEIGHT	W.L.L.
606005	1/4 x 2"	Shoulder	.06	500 lb.
	1/4 x 4"	Shoulder	.09	500 lb.
606008	5/16 x 2-1/4"	Shoulder	.11	800 lb.
	5/16 x 4-1/4"	Shoulder	.15	800 lb.
606014	1/2 x 6"	Shoulder	.68	2200 lb.
606015	5/8 X 6"	Shoulder	1	3500 lb.

DO NOT EXCEED WORKING LOAD LIMIT  
NEVER INSERT ONLY POINT OF HOOK. ALWAYS USE A SHACKLE.

## RATCHET BUCKLES

ITEM #	SIZE	W.L.L.	BREAKING STRENGTH
930029	2" Ratchet	1466 lb./666 kg.	4,000 lb./2000 kg.

ITEM #	SIZE	W.L.L.	BREAKING STRENGTH
930028	2" Ratchet - Short Narrow	3666 lb./1666 kg.	11,000 lb./5,000 kg.

ITEM #	SIZE	W.L.L.	BREAKING STRENGTH
649410	2" Ratchet - Short Wide Handle	3666 lb./1666 kg.	11,000 lb./5,000 kg.

ITEM #	SIZE	W.L.L.	BREAKING STRENGTH
649407	2" Ratchet - Wide Handle	3666 lb./1666 kg.	11,000 lb./5,000 kg.

ITEM #	SIZE	W.L.L.	BREAKING STRENGTH
649408	3" Ratchet - Long Wide Handle	7333 lb./3333 kg.	22,000 lb./10,000

ITEM #	SIZE	W.L.L.	BREAKING STRENGTH
930030	4" Ratchet - Long Wide Handle	8000 lb./3636 kg.	24,000 lb./11,000 kg.

ITEM #	SIZE	W.L.L.	BREAKING STRENGTH
649409	1" Ratchet - Wide Handle	1100 lb./500 kg.	3300 lb./1500 kg.

ITEM #	SIZE	W.L.L.	BREAKING STRENGTH
930031	1" Cam Buckle	500 lb./227 kg.	1500 lb./ 681 kg.
930034	2" Cam Buckle	1000 lb./454 kg.	3000 lb./1363 kg.

ITEM #	SIZE	W.L.L.	BREAKING STRENGTH
930035	2" Over-Center Buckle	1100 lb./500 kg.	3300 lb./1500 kg.





## ACCESSORIES

### SPRING "E" FITTINGS

ITEM #	SIZE	BREAKING STRENGTH
930041	2"	4500 lb. / 2045 kg.



### ROPE TIE OFF

"F" FITTING & WIRE HOOK AVAILABLE

ITEM #	CORD TIE OFF	W.L.L.
649540	with E Spring Fitting	1170 lb.



### BUTTERFLY "F" FITTING

ITEM #	SIZE	BREAKING STRENGTH
930050	1" hole	1500 lb. / 380kg.



### SPRING "E" FITTING with RING

ITEM #	SIZE	BREAKING STRENGTH
649541	2"	4500 lb. / 2045 kg.



### SNAP HOOK

ITEM #	DESCRIPTION
930040	for 2" strap



### "J" HOOK - Plastic Coated

ITEM #	SIZE	BREAKING STRENGTH
930015	1"	2500 lb. / 1100kg.



### D RINGS

ITEM #	DESCRIPTION
930046	2" D Ring
930043	1" D Ring



### WIRE HOOKS

ITEM #	DESCRIPTION
930022	5/8" for 3" strap
930020	1/2" for 2' strap
930018	3/8" for 2" strap
930017	1/4" for 2" strap
930016	1/4" for 1" strap



### FLAT HOOKS

ITEM #	DESCRIPTION
930032	for 4" strap
930023	for 3" strap
930021	for 2" strap



### DELTA RING

ITEM #	DESCRIPTION
930014	for 4" strap
930013	for 3" strap
930012	for 2" strap



### CHAIN END

ITEM #	DESCRIPTION
930007	4" Chain end Grade 70
930006	3" Chain end Grade 70
930005	2" Chain end Grade 70

### RECESSED FLOOR ANCHOR RING

ITEM #	DESCRIPTION	BREAKING STRENGTH
649620	Ring Kit - recessed with square base	5,000 lb.

649621 Ring Kit - recessed with back plate and bolts H.D.



### DOOR PULL STRAP

ITEM #	SIZE	DESCRIPTION
649554	18"	For overhead or side doors
649555	24"	and access to wheel carts.
649556	36"	



### FLOOR CHAIN TIE DOWN

ITEM #	DESCRIPTION	W.L.L.
650613	Floor chain tie-down Welded to trailer cross member. Unit sits flush to the floor. Pull on cap to expose chain. For use on steel frame trailer, with standard hard wood floor.	5400 lb.



### BEAM SOCKET

ITEM #	DESCRIPTION
649430	Zinc plated, with locking mechanism Use with 2" x 6' commercial grade lumber. W.L.L. varies depending on quality of lumber.



## LOGISTIC TRACK

### COMBI "E & F" TRACK - GALVANIZED - 10 ft.

ITEM #	DESCRIPTION
649399	Material: High strength 12-gauge steel Minimum Yield: 43,000 psi Weight: 17 lbs. / 7.7kg. Length: 10 feet / 3m
649400	Standard Series E Track - available on request

### SERIES "F" TRACK - GALVANIZED - 10 ft.

ITEM #	DESCRIPTION
649406	Material: High strength 14-gauge steel Minimum Yield: 43,000 psi Weight: 7.6 lbs. / 3.4 kg.

### SERIES "L" TRACK - GALVANIZED - 10 ft.

ITEM #	DESCRIPTION
649405	Material: High strength 12-gauge steel Minimum Yield: 50,000 psi Weight: 12 lbs. / 5.4 kg.

**CAUTION:** Welding of galvanized track should be done only in a well ventilated area to avoid toxic fumes.

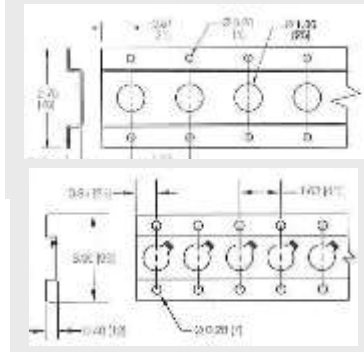

1" ROUND HOLE



BEAM PIN

BEAM HEAD

## ALUMINUM / ALL STEEL / ALL STEEL EXTRA LONG



RACK ASSEMBLY

CARGO STAY FOOT



## 1" ROUND SERIES "E"



## 1" SQUARE "F" SERIES

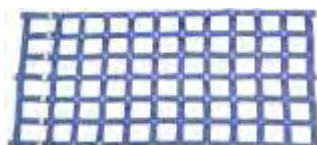

## DECKING BEAMS - ALUMINUM

ITEM #	DESCRIPTION	W.L.L. 2000 LB.
649415	Adjustment Range: 90.8" - 101.7". Decking / Vertical Weight 21 lb. 606 1T6 Head Assemblies are all steel, Zinc plated. Tapered for ease of operation.	
930551	Replacement Pin for decking beam socket.	
930550	Beam Head	

## CARGO STAYS - HEAT TREATED ALUMINUM

ITEM #	DESCRIPTION
649427	1-1/2" dia. Adjusts from 89.75 to 104.5" Moulded rubber feet for firm grip.
649424	Rack, lever and housing assembly
649422	Large foot - each
649421	Small Foot - each

## SHORING BAR - GALVANIZED

ITEM #	DESCRIPTION	SUPPORTS 500 LB.
649436	Spring-load designed for quick installation. H.D. Adjusts from 93" to 108". Weight 21 lb.	

**WARNING** Do not use shoring bar in decking applications.

## SHORING BAR - GALVANIZED

ITEM #	DESCRIPTION	SUPPORTS 1000LB.
649420	Easy installation Adjusts from 89" to 104". Weight 27 lb.	

**WARNING** Do not use shoring bar in decking applications.

## JACK BARS Heavy-duty universal square bar.

ITEM #	DESCRIPTION
649419	Adjusts 86" - 104" Bolt-on non-slip feet. Ideal for shoring, and most other interior van applications.

## CARGO HOOP SET

ITEM #	DESCRIPTION	WEIGHT (SINGLE) 10 LB.
649426	Hoop dimensions 26.75 x 28.25 For use on aluminum and steel cargo bars, To hold a larger surface area. For interior shoring applications.	

## CARGO NETS

ITEM #	DESCRIPTION	W.L.L.
	1-inch webbing	500 lb. / 227 kg.
	2-inch webbing	1000 lb. / 454 kg.

Custom made to your specifications. Attach to van walls by adjustable buckles and "E" fittings, or snaps or wire hooks.

Yellow Straps  
12' long



Grey Straps  
16' long



Blue Straps  
20' long



## 2" LOGISTIC STRAPS

with Ratchet Buckle for light to medium loads.  
All logistic straps have a 4' fixed end.

ITEM #	STRAP LENGTH	END HARDWARE	W.L.L.	BREAKING STRENGTH
649500	12'	"E" Fitting	1500 lb.	4500 lb.
649501	16'	"E" Fitting	1500 lb.	4500 lb.
649502	20'	"E" Fitting	1500 lb.	4500 lb.

649750	12'	Wire Hook	500 lb.	1500 lb.
649752	16'	Wire Hook	500 lb.	1500 lb.
649754	20'	Wire Hook	500 lb.	1500 lb.

649546	12'	"F" Butterfly	420 lb.	1250 lb.
649544	16'	"F" Butterfly	420 lb.	1250 lb.
649545	20'	"F" Butterfly	420 lb.	1250 lb.

## 2" LOGISTIC STRAPS

WITH CAM BUCKLE

ITEM #	STRAP LENGTH	END HARDWARE	W.L.L.	BREAKING STRENGTH
649510	12'	"E" Fitting	835 lb.	2500 lb.
649511	16'	"E" Fitting	835 lb.	2500 lb.
649512	20'	"E" Fitting	835 lb.	2500 lb.

649566	12'	Wire Hook	500 lb.	1500 lb.
649568	16'	Wire Hook	500 lb.	1500 lb.
649570	20'	Wire Hook	500 lb.	1500 lb.

649560	12'	"F" Butterfly	420 lb.	1250 lb.
649562	16'	"F" Butterfly	420 lb.	1250 lb.
649564	20'	"F" Butterfly	420 lb.	1250 lb.

## 2" LOGISTIC STRAPS

WITH OVER-CENTER BUCKLE

ITEM #	STRAP LENGTH	END HARDWARE	W.L.L.	BREAKING STRENGTH
649520	12'	"E" Fitting	1500 lb.	4500 lb.
649521	16'	"E" Fitting	1500 lb.	4500 lb.
649522	20'	"E" Fitting	1500 lb.	4500 lb.
649770	12'	Narrow	500 lb.	1500 lb.
649771	16'	Wire	500 lb.	1500 lb.
649772	20'	Hook	500 lb.	1500 lb.

## 1" UTILITY RATCHET STRAPS "PACKAGED"

ITEM #	STRAP LENGTH	END HARDWARE	W.L.L.	BREAKING STRENGTH
649012	12'	Wire Hook	1000 lb.	3000 lb.
649016	16'	Wire Hook	1000 lb.	3000 lb.

## 1" UTILITY RATCHET STRAPS

ITEM #	STRAP LENGTH	END HARDWARE	W.L.L.	BREAKING STRENGTH
649780	16'	Wire hk & D-ring	1000 lb.	3000 lb.
649781	20'	Wire hk & D-ring	1000 lb.	3000 lb.

## 1" UTILITY RATCHET STRAPS

ITEM #	STRAP LENGTH	END HARDWARE	W.L.L.	BREAKING STRENGTH
	16'	Snap Hook	1000 lb.	3000 lb.
	20'	Snap Hook	1000 lb.	3000 lb.

UTILITY TIE DOWNS ARE USED FOR MOST LIGHT DUTY RESTRAINT APPLICATIONS, pickup trucks, utility trailers, car top racks, boats, motorcycles and TV trailers.



# Packaged CARGO CONTROL STRAPS



650042



650041



650021



650022



650020



650024



650025



650001



650002



650003



650004



650040



650023



650000



650005



**Display Stand**

**ONE FREE DISPLAY STAND WITH THE ORDER OF ONE OR MORE START-UP KITS**

SEE NEXT PAGE FOR KIT QUANTITIES



650054



650051



650053

# 1" CARGO CONTROL STRAPS

## Display Packaged CARGO CONTROL STRAPS

NYLON WEBBING

START-UP KIT  
QUANTITIES



ITEM #	PACKAGE	SIZE	DESCRIPTION	WLL	
650000	4 Pack Combo	2 - 1"x10' 2 - 1"x6'	Ratchet Cam	400# 200#	3 pkgs.
650001	4 Pack	4 - 1"x15'	Ratchet	400#	4 pkgs.
650002	4 Pack	4 - 1"x6'	Cam	200 #	3 pkgs.
650003	4 Pack	4 - 1"x10'	Ratchet	300 #	2 pkgs.
650004	4 Pack	4 - 1"x15'	Ratchet with Rubber Handle	700 #	4 pkgs.
650005	4 Pack Combo	2 - 1"x6' 2 - 1"x10'	Cam - Camouflage Cam - Camouflage	200 # 200 #	3 pkgs.
650020	2 Pack	2 - 1"x15'	Ratchet	400#	5 pkgs.
650021	2 Pack	2 - 1"x6'	Cam	200#	3 pkgs.
650022	2 Pack	2 - 1"x10'	Ratchet	300#	2 pkgs.
650023	2 Pack	2 - 1.5"x15'	Ratchet with Rubber Handle	1000 #	6 pkgs.
650024	2 Pack	2 - 1"x15'	Ratchet with Rubber Handle	700 #	3 pkgs.
650025	2 Pack	2 - 1"x15'	Ratchet with Rubber Handle - Camouflage	400 #	3 pkgs.
650040	Single Pack	1 - 1.5"x15'	Ratchet with Rubber Handle	700 #	6 pkgs.
650041	Single Pack	1 - 1"x15'	Ratchet	400 #	4 pkgs.
650042	Single Pack	1 - 1"x10'	Cam	200#	4 pkgs.
650051	Single Bag	1 - 2"x 15'	Tow Strap		2 pkgs.
650053	10 Pack - 2 each	13", 18", 24", 30" 36"	Bungee Assortment		6 pkgs.
650054	6 Pack - 2 each	9", 15", 21"	Rubber Tie Down Assortment		8 pkgs.

930100 - Display Stand  
650027 - Starter Kit as listed above

WORKING TOGETHER TO ENSURE A STRONG FUTURE



# TIRE CHAIN

## SINGLE



## DUAL



## TRIPLE



## TRUCK TIRE CHAIN (ALSO AVAILABLE WITH STUDDED CROSS CHAIN)

ITEM #	9/32"	ITEM #	5/16"	ITEM #	3/8" 9.5	TIRE SIZE
507950		508328		508342		10.00-20 11.22.5
				508341		10-R-20 11-R-22.5
507951		508350		508357		10.00-22 11-24.5
				508354		1-R-22 11-R-24.5
		508360		508368		11.00-20 12-22.5
						11-R-20 12-R-22.5
		508382		508370		12.00-20 12-R-20
		508403				12-24.5 11-R-22
						11.00-22 12-R-24.5
ITEM #	5/16"	ITEM #	3/8" 9.5	TIRE SIZE		
508329		508330		10.00-20 11-22.5		
				10-R-20 11-R-22.5		
508361		508400		10.00-22 11-24.5		
				10-R-22 11-R-24.5		
508380		508369		11.00-20 12-22.5		
508424				11-R-20 12-R-22.5		
				12.00-20 12-R-20		
ITEM #	3/8" 9.5	TIRE SIZE				
		10.00-20 11-22.5 10-R-20 11-R-22.5				
508358		10.00-22 11-24.5				
508355		10-R-22 11-R-24.5				
508367		11.00-20 12-22.5 11-R-20 12-R-22.5				
	12.00-20 12-R-20 11.00-22 12-R-24.5 11-R-22 12-R-24.5					

Available for most tire sizes.

## FORK LIFT TIRE CHAIN

TIRE SIZE	CHAIN SIZE
508050 6.50 x 10	7/32"
508074 7.50 x 10	7/32"
508073 900 x 10	7/32"
508004 700 x 12	7/32"
508005 700 x 15	7/32"
508002 750 x 15 x 30	7/32"
508002 750 x 15 x 32	7/32"
508015 7.50 x 15 x 30	5/16"
508077 250 x 15	7/32"
508068 28 x 12.5 x 15	5/16"
508008 825 x 15	5/16"
508048 750 x 16	5/16"
508047 32 x 12.1 x 15	5/16"
508068 28 x 12.50 x 15	5/16"
508059 28 x 9 x 15	5/16"
508044 31 x 10.50 x 15	5/16"
508090 27 x 10.50 x 15	5/16"

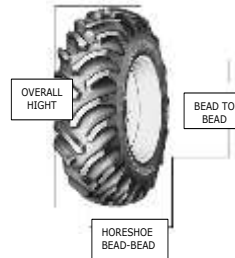

THREE TIRE DIMENSIONS ARE NEEDED TO ORDER THESE TIRES



## ATV V-BAR TIRE CHAIN 7/32"/5.5mm

ITEM #	TIRE SIZE
525006 ht 20 Rim 9 hs 21	21x11x8 41x17
525001 (14 cross chains)	22x11x8 22x12x8
525003 (14 cross chains)	25x8x12 48 x 15
525004 (14 cross chains)	25x10x12 44x17
525015	25x12x9
525005 (14 cross chains)	24x11x10 51x21
525020 ht 25 Rim 10 hs 22	25x13x9x 48x19.25
520241 (14 cross chains)	23x10.5x12 56x14.5
525010	24x9x11

## CROSS CHAIN HOOK



ITEM #	CHAIN SIZE
505055	7/32"
505063	1/4"
505080	5/16"
505100	3/8"
505110	7/16"

## QUICK LINK - ZINC



ITEM #	SIZE	W.L.L.
503406	1/4"	880 lb.
503408	5/16"	1,540 lb.
503410	3/8"	1,980 lb.
503411	1/2"	3,300 lb.

## REPAIR LINK



ITEM #	CHAIN SIZE
503706	1/4"
503708	5/16"
503710	3/8"
503713	1/2"

## SIDE CHAIN



ITEM #	SIZE	SIDE CHAIN
501053	1/4"	
501050	7/32"	
501086	5/16"	
501101	3/8"	
501125	7/16"	

## CROSS CHAIN



ITEM #	SIZE	CROSS CHAIN
500055	7/32"	
500060	1/4"	Hardened
500081	5/16"	Hardened
500096	3/8"/9.5mm	Hardened
500110	7/16"	Hardened

## STUDDED CROSS



ITEM #	SIZE	CROSS CHAIN
500208	5/16"	Studded
500210	3/8"	Studded
500211	7/16"	Studded

## CHAIN LOCKS



ITEM #	CHAIN SIZE	
503009	1/4"	# 555
503015	5/16"	# 889
503014	3/8"	# 1011
ITEM #	CHAIN SIZE	
503016	5/16"	# 675
503018	3/8"	# 714

FOR MORE TIRE CHAINS SEE PRICE LIST

# *Cargo Control*

## *components*



**Flat Bed & Interior Van  
Tie Down Accessories**

## CARGO CONTROL BOOK SEPTEMBER 2020

PAGE #	ITEM #	DESCRIPTION
1	649313	Winch - HD small frame - solid barrel - slider - weld on - short - with washers - black
1	649315	Winch - HD small frame - solid barrel - slider - weld on - short - no washers - black
1	649375	Winch - HD small frame - solid barrel - slider - weld-on - no washer - zinc
1	649373	Winch - HD small frame - solid barrel - slider - weld-on - with washer - zinc
1	649314	Winch - HD long frame - solid barrel - slider - no washer - black
1	649374	Winch - HD long frame - solid barrel - slider - no washer - zinc
1	649382	Winch - HD long frame - solid barrel - slider - with washer - zinc
1	649324	Winch - portable - low profile - with set screws
1	649360	Winch - portable - standard - with 2 set screws
1	649325	Winch - loose frame - weld on
1	649327	Winch - standard - weld on - no washers
1	649326	Winch - Low profile - Weld-on
1	649328	Winch - Low profile - Slider
1	649350	Winch - 3 bar - weld on - painted
1	649351	Winch - 3 bar - weld on - primed
1	649355	Winch - low profile - bottom mount
2	649312	Winch - lashing
2	649301	Web Winder
2	649305	Winch Track
2	649306	Winch Bar - heavy duty - black painted
3	649308	Winch Bar - heavy duty - chrome
2	649309	Winch Bar - heavy duty - combination - chrome
2	649300	5 <sup>th</sup> Wheel Puller- 28" - chrome
2	649602	Rubber Tarp Ties - 9"
2	649603	Rubber Tarp Ties - 15"
2	649604	Rubber Tarp Ties - 21"
2	649606	Rubber Tarp Ties - 31"
2	649607	Rubber Tarp Ties - 41"
2	649600	S Hook for tarp ties
2	649462	Corner Protector plastic 12"
2	649460	Corner Protector plastic for 2" to 4" webbing
2	649329	Corner Protector steel - for 2" webbing, cable, chain
2	649331	Corner Protector steel - for 2"- 4" webbing
2	649105	Wear Sleeve for 2" webbing
2	649106	Wear Sleeve for 3" webbing
2	649097	Wear Sleeve for 4" webbing
2	649107	Wear Sleeve velcro for 3" webbing
2	649610	Rubber Wheel Chock - A pyramid
2	649611	Rubber Wheel Chock - B
2	649626	D-Ring 1/2" with weld-on bracket self colour
2	649632	D-Ring 5/8" with weld-on bracket self colour
2	649636	D-Ring 3/4" with weld-on bracket self colour
2	649638	D-Ring 1" with weld-on bracket self colour
2	649645	D-Ring 1" long bent w/weld-on strap self colour
2	649646	D-Ring 1" short w/weld-on strap self colour
3	649023	Winch Strap 2" x 20' with wire hook
3	649026	Winch Strap 2" x 25' with wire hook
3	649027	Winch Strap 2" x 30' with wire hook
3	649036	Winch Strap 2" x 25' with flat hook
3	649037	Winch Strap 2" x 30' with flat hook
3	649056	Winch Strap 2" x 25' with delta ring
3	649057	Winch Strap 2" x 30' with delta ring
3	649063	Winch Strap 2" x 15' with snap
3	649062	Winch Strap 2" x 20' with snap
3	649066	Winch Strap 2" x 25' with snap
3	649061	Winch Strap 2" x 30' with snap
3	649046	Winch Strap 2" x 25' chain end
3	649047	Winch Strap 2" x 30' chain end

**CARGO CONTROL BOOK** SEPTEMBER 2020

PAGE #	ITEM #	DESCRIPTION
3	649100	Winch Strap 3" x 25' with wire hook
3	649102	Winch Strap 3" x 30' with wire hook
3	649110	Winch Strap 3" x 25' with flat hook
3	649112	Winch Strap 3" x 30' with flat hook
3	649130	Winch Strap 3" x 30" with delta ring
3	649120	Winch Strap 3" x 25" with chain end 5/16" hook
3	649117	Winch Strap 3" x 30" with chain end 5/16" hook
3	649124	Winch Strap 3" x 40" with chain end 5/16" hook
3	649135	Winch Strap 3" x 30" with chain end 3/8" hook
3	649133	Winch Strap 3" x 30" with chain end 3/8" hook & chain grade 40
4	649199	Winch Strap 4" x 30' with wire hook
4	649200	Winch Strap 4" x 25' with flat hook
4	649202	Winch Strap 4" x 30' with flat hook
4	649230	Winch Strap 4" x 25' with delta ring
4	649232	Winch Strap 4" x 30' with delta ring
4	649220	Winch Strap 4" x 25' with chain end
4	649222	Winch Strap 4" x 30' with chain end
4		Winch Strap 4" x 30' with loop
4	649242	Winch Strap 4" x 30' with snap
		<b>COMPLETE 2" RATCHET ASSEMBLY with Long Wide Handle</b>
5	649075	<b>Ratchet &amp; Strap 2" x 27' w/3/8" Wire Hook</b>
5	649077	<b>Ratchet &amp; Strap 2" x 27' w/ Flat Hook</b>
5	649079	<b>Ratchet &amp; Strap 2" x 27' w/Chain End</b>
5	649820	2" Ratchet Assembly Complete - long wide handle -25' Strap - 1/2" wire hooks
5	649028	2" Ratchet Assembly Complete - long wide handle -30' Strap - 1/2" wire hooks
5	649070	2" Ratchet Assembly Complete - long wide handle -20' Strap - 3/8" wire hooks
5	649828	2" Ratchet Assembly Complete - long wide handle -25' Strap - 3/8" wire hooks
5	649072	2" Ratchet Assembly Complete - long wide handle -30' Strap - 3/8" wire hooks
5	649821	2" Ratchet Assembly Complete - long wide handle -25' Strap - flat hooks
5	649822	2" Ratchet Assembly Complete - long wide handle -30' Strap - flat hooks
5		2" Ratchet Assembly Complete - long wide handle -20' Strap - delta ring
5		2" Ratchet Assembly Complete - long wide handle -25' Strap - delta ring
5		2" Ratchet Assembly Complete - long wide handle -30' Strap - delta ring
5		2" Ratchet Assembly Complete - long wide handle -20' Strap - snap
5		2" Ratchet Assembly Complete - long wide handle -25' Strap - snap
5	649825	2" Ratchet Assembly Complete - long wide handle -30' Strap - snap
5	649823	2" Ratchet Assembly Complete - long wide handle -25' Strap - chain end
5	649824	2" Ratchet Assembly Complete - long wide handle -30' Strap - chain end
5		2" Ratchet Assembly Complete - short wide handle -20' strap - 1/2" wire hooks
5		2" Ratchet Assembly Complete - short wide handle -25' strap - 1/2" wire hooks
5		2" Ratchet Assembly Complete - short wide handle -30' strap - 1/2" wire hooks
5	649759	2" Ratchet Assembly Complete - short wide handle -20' strap - 3/8" wire hooks
5	649760	2" Ratchet Assembly Complete - short wide handle -25' strap - 3/8" wire hooks
5	649762	2" Ratchet Assembly Complete - short wide handle -30' strap - 3/8" wire hooks
5		2" Ratchet Assembly Complete - short wide handle -20' strap - flat hooks
5		2" Ratchet Assembly Complete - short wide handle -25' strap - flat hooks
5	649793	2" Ratchet Assembly Complete - short wide handle -30' strap - flat hooks
5		2" Ratchet Assembly Complete - short wide handle -20' strap - 1/2" delta ring
5		2" Ratchet Assembly Complete - short wide handle -25' strap - 1/2" delta ring
5		2" Ratchet Assembly Complete - short wide handle -30' strap - 1/2" delta ring
5		2" Ratchet Assembly Complete - short wide handle -20' strap - snap
5		2" Ratchet Assembly Complete - short wide handle -25' strap - snap
5		2" Ratchet Assembly Complete - short wide handle -30' strap - snap
5		2" Ratchet Assembly Complete - short wide handle -25' strap - chain end
5	649792	2" Ratchet Assembly Complete - short wide handle -30' strap - chain end
6		2" Ratchet Assembly Complete - short narrow handle -20' strap - 3/8" wire hooks
6	649029	2" Ratchet Assembly Complete - short narrow handle -25' strap - 3/8" wire hooks
6	649791	2" Ratchet Assembly Complete - short narrow handle -30' strap - 3/8" wire hooks
6		2" Ratchet Assembly Complete - short narrow handle -20' strap - flat hooks
6		2" Ratchet Assembly Complete - short narrow handle -20' strap - flat hooks
6		2" Ratchet Assembly Complete - short narrow handle -20' strap - flat hooks

**CARGO CONTROL BOOK** SEPTEMBER 2020

PAGE #	ITEM #	DESCRIPTION
6		2" Ratchet Assembly Complete - short narrow handle - 20' strap - delta ring
6		2" Ratchet Assembly Complete - short narrow handle - 20' strap - delta ring
6		2" Ratchet Assembly Complete - short narrow handle - 20' strap - delta ring
6		2" Ratchet Assembly Complete - short narrow handle - 20' strap - chain end
6		2" Ratchet Assembly Complete - short narrow handle - 20' strap - chain end
6		3" Ratchet Assembly Complete - long wide handle - 25' strap - 1/2" wire hooks
6		3" Ratchet Assembly Complete - long wide handle - 30' strap - 1/2" wire hooks
6	649826	3" Ratchet Assembly Complete - long wide handle - 25' strap - flat hooks
6		3" Ratchet Assembly Complete - long wide handle - 30' strap - flat hooks
6		3" Ratchet Assembly Complete - long wide handle - 25' strap - delta ring
6		3" Ratchet Assembly Complete - long wide handle - 30' strap - delta ring
6		3" Ratchet Assembly Complete - long wide handle - 25' strap - snap
6		3" Ratchet Assembly Complete - long wide handle - 30' strap - snap
6		3" Ratchet Assembly Complete - long wide handle - 25' strap - grab hooks
6		3" Ratchet Assembly Complete - long wide handle - 30' strap - grab hooks
6		3" Ratchet Assembly Complete - long wide handle - 25' strap - chain ends
6	649127	3" Ratchet Assembly Complete - long wide handle - 30' strap - chain ends
6		4" Ratchet Assembly Complete - long wide handle - 25' strap - flat hooks
6	649829	4" Ratchet Assembly Complete - long wide handle - 30' strap - flat hooks
6		4" Ratchet Assembly Complete - long wide handle - 25' strap - delta ring
6		4" Ratchet Assembly Complete - long wide handle - 30' strap - delta ring
6		4" Ratchet Assembly Complete - long wide handle - 25' strap - chain ends
6	649830	4" Ratchet Assembly Complete - long wide handle - 30' strap - chain ends
7	649854	Wheel Tie Downs 1,666 lbs.
7	649855	Wheel Tie Downs 754 lbs.
7	649091	Towing Strap 2" x 20'
7	649092	Towing Strap 3" x 20'
7	649093	Towing Strap 4" x 20'
7	649094	Towing Strap 4" x 30'
8		Nylon Slings
9	649635	Binder Lock
9	604128	Standard Load Binder 1/4 - 5/16 grade 70
9	604132	Standard Load Binder 5/16- 3/8 grade 70
9	604140	Standard Load Binder 3/8 - 1/2 grade 70
9	604160	Safety Load Binder 5/16-3/8 grade 70
9	604161	Ratchet Load Binder 5/16-3/8 grade 70
9	604162	Ratchet Load Binder 3/8 -1/2 grade 70
9	604163	Ratchet Load Binder 1/2 -5/8 grade 70
9	605508	Wire Rope Assemblies 1/4" stainless 30' chain & grab hook end
9	605510	Wire Rope Assemblies 1/4" galvanized 30' 1/4" chain & 5/16" grab hook APRIL 12/21
9	605511	Wire Rope Assemblies 1/4" galvanized 32' 1/4" chain & 5/16" grab hook APRIL 12/21
9	605514	Wire Rope Assemblies 5/16" galvanized 30' 1/4" chain & 5/16" grab hook
9	605515	Wire Rope Assemblies 1/4" galvanized 30' 5/16" chain & 5/16" grab hook APRIL 12/21
9	503419	Wire Rope Clip 3/16" galvanized
9	503420	Wire Rope Clip 1/4" galvanized
9	503421	Wire Rope Clip 5/16" galvanized
9	503422	Wire Rope Clip 3/8" galvanized
9	604319	Wire Rope Thimble 3/16" galvanized zinc
9	604320	Wire Rope Thimble 1/4" galvanized zinc
9	604322	Wire Rope Thimble 5/16" galvanized zinc
9	604324	Wire Rope Thimble 3/8" galvanized zinc
9	604326	Wire Rope Thimble 1/2" galvanized zinc
9	604366	Swage Sleeve 3/16" aluminum oval
9	604364	Swage Sleeve 3/16" aluminum stop
9	604368	Swage Sleeve 3/16" aluminum spools
9	604369	Swage Sleeve 1/4" aluminum oval
9	604376	Swage Sleeve 1/4" aluminum stop
9	604370	Swage Sleeve 5/16" aluminum oval
9	604371	Swage Sleeve 3/8" aluminum oval

**CARGO CONTROL BOOK** SEPTEMBER 2020

PAGE #	ITEM #	DESCRIPTION
10	600125	Bulk Chain 3/16" grade 30 high test self colour 1600'/drum
10	600127	Bulk Chain 1/4" grade 30 high test self colour 900' /drum
10	600008	Bulk Chain 5/16" grade 30 high test self colour 600' /drum
10	600010	Bulk Chain 3/8" grade 30 high test self colour 400' /drum
10	600013	Bulk Chain 1/2" grade 30 high test self colour 250' /drum
10	601027	Bulk Chain 1/4" grade 70 yellow dichromate 800' /drum
10	601028	Bulk Chain 5/16" grade 70 yellow dichromate 550' /drum
10	601029	Bulk Chain 3/8" grade 70 yellow dichromate 400' /drum
10	601030	Bulk Chain 1/2" grade 70 yellow dichromate 98' /drum
10	601032	Bulk Chain 5/8" grade 70 yellow dichromate
10	601088	Chain Assemblies 5/16" grade 70 16' long with 2 grab hooks
10	601089	Chain Assemblies 5/16" grade 70 20' long with 2 grab hooks
10	601090	Chain Assemblies 5/16" grade 70 25' long with 2 grab hooks
10	601105	Chain Assemblies 3/8" grade 70 16' long with 2 grab hooks
10	601114	Chain Assemblies 3/8" grade 70 20' long with 2 grab hooks
10	601113	Chain Assemblies 3/8" grade 70 25' long with 2 grab hooks
10	604102	Clevis Grab Hook 1/4" grade 40 carbon steel
10	604103	Clevis Grab Hook 5/16" grade 40 carbon steel
10	604115	Clevis Grab Hook 3/8" grade 40 carbon steel
10	604116	Clevis Grab Hook 1/2" grade 40 carbon steel
10	604101	Clevis Grab Hook 1/4" grade 70 alloy steel
10	604168	Clevis Grab Hook 5/16" grade 70 alloy steel
10	604110	Clevis Grab Hook 3/8" grade 70 alloy steel
10	604114	Clevis Grab Hook 1/2" grade 70 alloy steel
10	604099	Clevis Slip Hook 1/4" grade 70 alloy steel
10	604169	Clevis Slip Hook 5/16" grade 70 alloy steel
10	604106	Clevis Slip Hook 3/8" grade 70 alloy steel
10	604118	Clevis Slip Hook 1/2" grade 70 alloy steel
10	604060	Clevis Slip Hook 1/4" with latch
10	604062	Clevis Slip Hook 5/16" with latch
10	604064	Clevis Slip Hook 3/8" with latch
10	604066	Clevis Slip Hook 1/2" with latch
10	604012	Clevis Slip Hook 5/8" with latch
10	604305	Double Clevis Link 1/4"- 5/16" grade 70 zinc plated
10	604308	Double Clevis Link 5/16"- 8/8" grade 70 zinc plated
10	604309	Double Clevis Link 3/8"- 1/2" grade 70 zinc plated
10	604306	Mid Link 1/4-5/16 grade 70 zinc plated
10	604310	Mid Link 3/8" grade 70 zinc plated
10	604311	Mid Link 1/2" grade 70 zinc plated
11	604164	Anchor Shackle 3/16" screw pin 1/4"
11	604208	Anchor Shackle 1/4" screw pin 5/16"
11	604214	Anchor Shackle 5/16" screw pin 3/8"
11	604210	Anchor Shackle 3/8" screw pin 7/16"
11	604211	Anchor Shackle 7/16" screw pin 1/2"
11	604213	Anchor Shackle 1/2" screw pin 5/8"
11	604216	Anchor Shackle 5/8" screw pin 3/4"
11	604219	Anchor Shackle 3/4" screw pin 7/8"
11	604220	Anchor Shackle 7/8" screw pin 1"
11	606005	Eye Bolt 1/4 x 2" shoulder type
11	606008	Eye Bolt 5/16 x 2-1/4 shoulder type
11	606014	Eye Bolt 1/2 x 6" shoulder type
11	606015	Eye Bolt 5/8 x 6" shoulder type

**CARGO CONTROL BOOK** SEPTEMBER 2020

PAGE #	ITEM #	DESCRIPTION
11	649500	2" Strap with Ratchet & "E" fittings 12'
11	649501	2" Strap with Ratchet & "E" fittings 16'
11	649502	2" Strap with Ratchet & "E" fittings 20'
11	649750	2" Strap with Ratchet & wire hooks 12'
11	649752	2" Strap with Ratchet & wire hooks 16'
11	649754	2" Strap with Ratchet & wire hooks 20'
11	649546	2" Strap with Ratchet & "F" butterfly fittings 12'
11	649544	2" Strap with Ratchet & "F" butterfly fittings 16'
11	649545	2" Strap with Ratchet & "F" butterfly fittings 20'
11	649510	2" Strap with Cam Buckle & "E" fittings 12'
11	649511	2" Strap with Cam Buckle & "E" fittings 16'
11	649512	2" Strap with Cam Buckle & "E" fittings 20'
11	649566	2" Strap with Cam Buckle & wire hooks 12'
11	649568	2" Strap with Cam Buckle & wire hooks 16'
11	649570	2" Strap with Cam Buckle & wire hooks 20'
11	649560	2" Strap with Cam Buckle & "F" butterfly fittings 12'
11	649562	2" Strap with Cam Buckle & "F" butterfly fittings 16'
11	649564	2" Strap with Cam Buckle & "F" butterfly fittings 20'
11	649520	2" Strap with Over-center Buckle & "E" fittings 12'
11	649521	2" Strap with Over-center Buckle & "E" fittings 16'
11	649522	2" Strap with Over-center Buckle & "E" fittings 20'
11	649770	2" Strap with Over-center Buckle & wire hooks 12'
11	649771	2" Strap with Over-center Buckle & wire hooks 16'
11	649772	2" Strap with Over-center Buckle & wire hooks 20'
12	930029	2" Ratchet Buckle
12	930028	2" Ratchet with short handle
12	649410	2" Ratchet with short wide handle
12	649407	2" Ratchet with wide handle
12	649408	3" Ratchet with long wide handle
12	930030	4" Ratchet with long wide handle
12	649409	1" Ratchet with wide handle
12	930031	1" Cam Buckle
12	930034	2" Cam Buckle
12	930035	2" Over-center Buckle
13	930041	"E" Spring Fitting
13	930050	"F" Butterfly Fitting
13	649540	Rope Tie Off with "E" Fitting with ring
13	649541	"E" spring fitting w/ring
13	930040	Snap Hook 2"
13	930015	J Hook 1"
13	930046	D ring 2"
13	930043	D Ring 1"
13	930022	Wire Hook 5/8" for 3" strap
13	930020	Wire Hook 1/2" for 2" strap
13	930018	Wire Hook 3/8" for 2" strap
13	930017	Wire Hook 1/4" for 2" strap
13	930016	Wire Hook 1/4" for 1" strap
13	930032	Flat Hook for 4" strap
13	930023	Flat Hook for 3" strap
13	930021	Flat Hook for 2" strap
13	930014	Delta Ring for 4" strap
13	930013	Delta Ring for 3" strap
13	930012	Delta Ring for 2" strap
13	930007	Delta Ring 4" with grade 70 Chain End
13	930006	Delta Ring 3" with grade 70 Chain End
13	930005	Delta Ring 2" with grade 70 Chain End

## CARGO CONTROL BOOK SEPTEMBER 2020

Page #	Item #	Description
13	649620	Recessed Floor Anchor Ring 1200#
13 new	649621	Recessed Floor Rope Kit with back plate and bolts - Heavy Duty
13	649554	Door Pull Strap 18"
13	649555	Door Pull Strap 24"
13	649556	Door Pull Strap 36"
13	650613	Floor Chain Tie Down
13	649430	Socket with locking mechanism for Decking Beam
14	649399	Logistic Track Combi E-F
14	649402	Logistic Track series "E" 12 gauge 10' Vertical
14	649406	Logistic Track series "F" 4 gauge 10'
14	649415	Decking Beam
14	930551	Decking Beam Pin
14	930550	Decking Beam Head
14	649427	Cargo Stay aluminum
14	649423	Cargo Stay aluminum
14	649429	Cargo Stay all steel
14	649424	Rack Assembly for cargo stay
14	649422	Foot - large for cargo stay
14	649421	Foot - small for cargo stay
14	649420	Shoring Bar 1" square - series "F"
14	649419	Jack Bar
14	649426	Cargo Hoop Set

## PACKAGED CARGO CONTROL

Page #	Item #	Description
15	650000	4 Pack Combo 2 - 1"x10' Ratchet 2 - 1"x6' Cam
15	650001	4 Pack 4 - 1"x15' Ratchet
15	650002	4 Pack 4 - 1"x6' Cam
15	650003	4 Pack 4 - 1"x10' Ratchet
15	650004	4 Pack 4 - 1"x15' Ratchet with Rubber Handle
15	650005	4 Pack Combo 2 - 1"x6' Cam - Camouflage 2 - 1"x10' Cam - Camouflage
15	650020	2 Pack 2 - 1"x15' Ratchet
15	650021	2 Pack 2 - 1"x6' Cam
15	650022	2 Pack 2 - 1"x10' Ratchet
15	650023	2 Pack 2 - 1.5"x15' Ratchet with Rubber Handle
15	650024	2 Pack 2 - 1"x15' Ratchet with Rubber Handle
15	650025	2 Pack 2 - 1"x15' Ratchet - Rubber Handle - Camouflage
15	650040	Single Pack 1 - 1.5"x15' Ratchet with Rubber Handle
15	650041	Single Pack 1 - 1"x15' Ratchet
15	650042	Single Pack 1 - 1"x10' Cam
15	650051	Single Bag 1 - 2"x 15' Tow Strap
15	650053	10 Pack - 2 ea. 13", 18", 24", 30" 36" Bungee Assortment
15	650054	6 Pack - 2 ea. 9", 15", 21" Rubber Tie Down Assortment
15	930100	DISPLAY STAND complete with hooks for packaged items
15	930096	BROCHURE HOLDER small (1-1/2) pocket for 8.7 x 11 sheets (as shown above)
15	930098	BROCHURE HOLDER deep (2-1/2) pocket for 8.7 x 11 sheets
16	649012	Utility Ratchet Strap 1" x 12' with wire hooks - packaged
16	649016	Utility Ratchet Strap 1" x 16' with wire hooks - packaged
16	649780	Utility Ratchet Strap 1' x 16' with wire hook and D ring
16	649781	Utility Ratchet Strap 1' x 20' with wire hook and D ring
16		Utility Ratchet Strap 1' x 16' with snap hooks
16		Utility Ratchet Strap 1' x 20' with snap hooks
17		See Tire Chain section for pricing



## Components Secured on Display Cards

LIST PRICE EFFECTIVE SEPTEMBER 1, 2020

ITEM #	PACKAGE	SIZE "	DESCRIPTION	
770007	1	1/4	Grab Hook	yellow zinc
770006	1	5/16	Grab Hook	yellow zinc
770008	1	3/8	Grab hook	yellow zinc
<hr/>				
770010	1	1/4	Slip Hook	yellow zinc
770015	1	5/16	Slip Hook	yellow zinc
770009	1	3/8	Slip Hook	yellow zinc
<hr/>				
770022	1	3/8	Double Clevis Link	zinc
770023	1	1/4 - 5/16	Double Clevis Link	zinc

## Components Heat Sealed on Display Cards

ITEM #	PACKAGE	SIZE "	DESCRIPTION	
770017	2 pk.	1/4 x 1	Repair Link	zinc
770018	2 pk.	5/16	Repair Link	zinc
<hr/>				
770030	1	5/16	Quick Link	zinc
770031	1	1/2	Quick Link	zinc
<hr/>				
770014	1	3/16	Anchor Shackle	galvanized
770020	1	1/4	Anchor Shackle	galvanized
770011	1	5/16	Anchor Shackle	galvanized
770019	1	3/8	Anchor Shackle	galvanized
770021	1	1/2	Anchor Shackle	galvanized
<hr/>				
770001	2 pk.	1/8	Wire Rope Clip	zinc
770004	2 pk.	3/16	Wire Rope Clip	zinc
770049	2 pk.	5/16	Wire Rope Clip	zinc
<hr/>				
770003	2 pk.	3/16	Wire Rope Thimble	zinc
770005	2 pk.	1/8	Wire Rope Thimble	zinc
<hr/>				
770048	4 pk.	1/4	Clamp Set	zinc
770002	4 pk.	5/16	Clamp Set	zinc
<hr/>				
770024	2 pk.	1/8	Ferrule & Stop Set	aluminum
770025	2 pk.	3/16	Ferrule & Stop Set	aluminum
770026	2 pk.	1/16	Ferrule & Stop Set	aluminum
770027	2 pk.	3/32	Ferrule & Stop Set	aluminum

## Components Heat Sealed on Display Cards

LIST PRICE EFFECTIVE SEPTEMBER 1, 2020

ITEM #	PACKAGE	SIZE "	DESCRIPTION	
	770034 2 pk.	1 x 3-1/2	Screw Eye	zinc
	770035 2 pk.	3/4 x 3	Screw Eye	zinc
	770028 1	2	Hitching Ring	
	770037 2 pk.	4	Utility Hook	zinc
	770046 1	1/4	Eye & Eye Swivel	galvanized
	770047 1	5/16	Eye & Eye Swivel	galvanized
	770012 1	1 x 4-1/4	Swivel Bolt Snap	nickel
	770013 1	3/8 x 2	Swivel Spring Snap	nickel
	770016 1	3/4 x 3-1/8	Swivel Quick Snap	nickel
	770042 1	1/4 x 2-3/8	Spring Link	zinc
	770043 1	5/16 x 3-1/4	Spring Link	zinc
	770044 1	3/8 x 3-1/2	Spring Link	zinc
	770039 1	1/2 x 5-1/2	Spring Link	zinc
	770040 4 pk.	Asst.	Spring Links	
	770038 1	9/16 x 4	Fixed Snap Hook	zinc
	770029 1	1-1/4	Swivel Pulley	nickel
	770033 1	5-1/8	Rope Hook	zinc

## TRYGG FAST TRAC

TIRE CHAIN  
SOLD / SET

LIST PRICE EFFECTIVE SEPTEMBER 1, 2020

**EXTRA STRONG**  
7mm CHAIN  
for SNOW REMOVAL  
& ROAD WORK



ITEM #	TIRE SIZE	CHAIN SIZE
507161	16.9-38	18.4x30
	480/70-30	18.4x34
	480/70-34	480/70-38
	480/80-30	480/80-38
	520/70-30	520/70-30
507162	540/65-30	540/65-34
	540/65-38	540/70-34
	14.9 x 28	14.9x30
	18.4x26	15.5x38
	380/85-2	380/85-30
507163	385/95-25	420/70-30
	420/85-28	420/70-34
	440/80-26	420/85-30
	480/65-28	420/85-34
	16.9 x 24	420/80-34
	480/70-28	420/70R24
	17.5 x 24	16.9 x 30
	14.9x20	14.9x24
	360/70-24	340/85-28
	360/70-28	360/80-24
507164	365/80-20	365/85-20
	380/70-20	375/75-20
	380/85-24	380/70-24
	405/70-18	380/70-28
	420/65-20	395/80-20
	11.2x28	400/80-24
	13.6x24	405/70-24
	300/70-24	44 x 80 x 20
320/85-24	15 x 19.5	
320/85-28	12.4x24	
340/85-24	12.4x28	
	13.6x28	
	280/85-28	
	320/70-24	
	320/70-28	
	320/85-28	
	340/80-24	

**SUPERB TRACTION**

**SMT**



## TRACTOR TIRE CHAIN - SMT STUDDED

ALL PURPOSE, ALL TERRAIN, STUDDED CHAIN, FOR ALL TIRE SIZES FOR ICE ROCK MUD OR DEEP SNOW

ITEM #	TIRE SIZE	CHAIN SIZE
507200	11.2 X 24	5/16"
507201	11.2 x 28	5/16"
507202	12.4 X 24	3/8"
507203	12.4 X 28	3/8"
507204	13.6 X 24	3/8"
507205	13.6 X 28	3/8"
507206	14.9 X 24	3/8"
507208	16.9 x 24, 14.9 X 28, 420/70R24	3/8
507209	16.9 X 28	3/8"
507210	16.9 X 30	3/8"
507211	18.4 X 30	3/8"
507212	18.4 X 34	3/8"
507213	18.4 x 38	3/8"
507215	20.8 X 38	3/8"

◆◆◆ Other sizes available on request ◆◆◆

## TWINWAY-SIX TRACTOR CHAIN

ITEM #	SIZE	STOCK #
506073	13.6-26, 13.6-28, 14.9-24, 14.9-26	6-9373
506074	14.9-28	6-9374
506076	13.6-36	6-9376
506077	13.6-38	6-9377
506078	14.9-38	6-9378
506087	16.9-24, 17.5L-24	6-9387
506089	16.9-28, 19.5L-24	6-9389
506090	16.9-30, 18.4-26	6-9390
506091	16.9-32, 18.4-28	6-9391
506092	16.9-34, 18.4-30, 15.5-38	6-9392
506094	18.4-34, 16.9-38	6-9394
506095	18.4 x 42	6-9395
506096	18.4-38	6-9396
506097	20.8-34, 23.1-26, 23.1-30	6-9397
506098	23.1-34, 20.8-38	6-9398

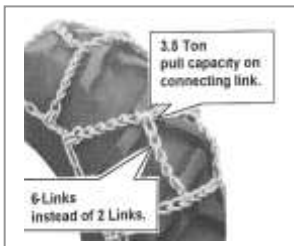

**TWINWAY-SIX STUDED TRACTOR CHAIN**

LIST PRICE EFFECTIVE SEPTEMBER 1, 2020

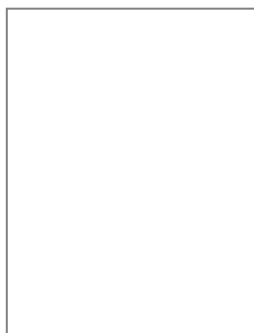

**TWINWAY-SIX  
WITH  
STUDED  
SECTIONS**

ITEM #	TIRE SIZE	STOCK#
506122	11.2-24	
506121	9.5-32, 11.2-28, 12.4-24, 15 x 19.5, 10 x 28	
506120	9.5-40, 11.2-36	
506119	9.5-36, 11.2-32, 12.4-28, 9.5-42, 11.2-38, 11.2-40, 12.4-36, 12.4-38	
506118	13.6x24, 13.6-26, 13.6-28, 14.9-24, 14.9-26,	
506117	14.9-28, 420/70R24	
506116	13.6-36, 14.9x30, 14.9x38	
506115	16.9-24, 17.5L-24	
506114	16.9-28, 18.4-24, 19.5L-24	
506113	16.9-30, 18.4-26, 16.9-32, 18.4-28	
506111	16.9-34, 18.4-30, 15.5-38	
506110	18.4-34, 16.9-38	
506109	18.4-38	

**TWINWAY-TWO TRACTOR CHAIN**TIRE CHAIN  
SOLD / SET

**3/8 CROSS CHAIN**

ITEM #	TIRE SIZE	STOCK#
502036	11.2-24	2-9336
502038	9.5-32, 11.2-28, 12.4-24, 15 x 19.5, 10 x 28	2-9338
502042	9.5-36, 11.2-32, 12.4-28	2-9342
502046	9.5-40, 11.2-36	2-9346
502048	9.5-42, 11.2-38, 11.2-40, 12.4-36, 12.4-38	2-9348
502073	13.6-26, 13.6-28, 14.9-24, 14.9-26	2-9373
502074	14.9-28, 420/70R24	2-9374
502076	13.6-36, 14.9x30	2-9376
502077	13.6-38	2-9377
502079	14.9-38	2-9379
502080	14.9x46	
502087	16.9-24, 17.5L-24	2-9387
502089	16.9-28, 18.4-24, 19.5L-24	2-9389
502090	16.9-30, 18.4-26	2-9390
502091	16.9-32, 18.4-28	2-9391
502092	16.9-34, 18.4-30, 15.5-38	2-9392
502094	18.4-34, 16.9-38	2-9394
502095	18.4 x 42	2-9395
502096	18.4-38	2-9396
502097	20.8-34, 23.1-26, 23.1-30	2-9397
502098	23.1-34, 20.8-38	2-9398

**TWINWAY-TWO  
WITH 3/8 V-BAR  
CROSS CHAIN**



ITEM #	TIRE SIZE	STOCK#
502136	11.2-24	2-9336
502138	9.5-32, 11.2-28, 12.4-24, 15 x 19.5, 10 x 28	2-9338
502142	9.5-36, 11.2-32, 12.4-28	2-9342
502146	9.5-40, 11.2-36	2-9346
502148	9.5-42, 11.2-38, 11.2-40, 12.4-36, 12.4-38	2-9348
502173	13.6-26, 13.6-28, 14.9-24, 14.9-26	2-9373
502174	14.9-28, 420/70R24	2-9374
502176	13.6-36, 14.9x30	2-9376
502177	13.6-38	2-9377
502179	14.9-38	2-9379
502187	16.9-24, 17.5L-24	2-9387
502189	16.9-28, 18.4-24, 19.5L-24	2-9389
502190	16.9-30, 18.4-26	2-9390
502191	16.9-32, 18.4-28	2-9391
502192	16.9-34, 18.4-30, 15.5-38	2-9392
502194	18.4-34, 16.9-38	2-9394
502195	18.4 x 42	2-9395
502196	18.4-38	2-9396
502198	23.1-34, 20.8-38	2-9398

## LAWN & GARDEN TRACTOR CHAIN

LIST PRICE EFFECTIVE SEPTEMBER 1, 2020

### 2-LINK SPACING 7/32"

4 Link Spacing available on request

ITEM #	TIRE SIZE
520101	16 x 6.50 x 8
518127	16 x 7.50 x 8
520100	18 x 6.50 x 8

520098	18 x 7.50 x 8
520102	18 x 8.50 x 8
520103	18 x 9.50 x 8
518214	18 x 8.50 x 10
520129	20 x 8.00 x 8
520105	20 x 10.0 x 8
520106	20 x 10.0 x 10

520181	22 x 11 x 10
520107	20.5 x 8 x 10
520148	21 x 7.00 x 10

520111	22 x 7.50 x 12
520166	22 x 8.00 x 12
520113	22 x 9.00 x 12

520112	23 x 8.50 x 12
520183	22 x 9.50 x 12
520114	23 x 9.50 x 12

520120	23 x 10.5 x 12
520115	23 x 12.50 x 12
520177	24 x 10.50 x 12
520138	24 x 12 x 12

520168	25 x 8.50 x 14
520211	25 x 12 x 9
520154	23 x 8.50 x 14
520122	26 x 12.00 x 12

### 4 LINK SPACING 5/16"

ITEM #	TIRE SIZE	
520201	7 x 16	Case Hardened
520128	8.3 x 16	Case Hardened
520215	800 x 18 Turf	Case Hardened
520147	9.5 x 16	Case Hardened
520301	9.5 x 24	Case Hardened
508027	10R 165	Case H. Also for Fork Lift
520306	12.4 x 16	Case Hardened
508054	12 R x 165	Case Hardened
520212	13.6 x 16	Case Hardened
520308	18.4 x 16.1	Case Hardened
520302	43 x 13.5 22	Case Hardened
520176	44 x 18 x 20	Case Hardened
520219	41 x 14.00 x 20	Case Hardened
520310	355 x 80-D x 20	Case Hardened
520421	43 x 16 x 20	Case Hardened
508459	27 x 10.50x 15	

### 2-LINK SPACING 7/32"

4 Link Spacing available on request

ITEM #	TIRE SIZE
520121	27 x 8.50 x 15
520125	27 x 9.50 x 15

520130	29 x 12.00 x 15
520135	31 x 13.50 x 15

520140	31 x 15.5 x 15
520311	212 x 80-D x 15

520213	33 x 12.50 x 15
520171	41 x 14.00 x 20

520206	25 x 10 x 12
--------	--------------

520205	24 x 8.5 x 12
520131	29 x 12.5 x 15

520141	7 x 16	Case Hardened
520146	8.3 x 16	Case Hardened

520144	9.50 x 16	Case Hardened
508129	12 x 16.5 LT	Case Hardened

520305	12.4 x 16	Case Hardened
520150	13.6 x 16	Case Hardened

520216	35 x 12.00 x 15	Case Hardened
520214	36 x 13.50 x 15	Case Hardened

508430	43 x 13.5 x 22	Case Hardened
520175	44 x 18 x 20	Case Hardened

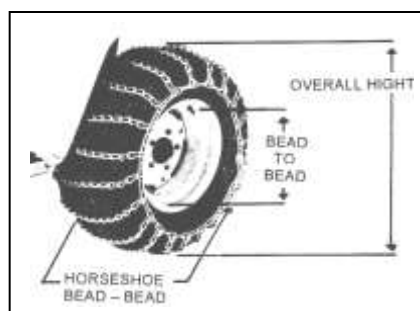

Three dimensions are needed as shown below, if your tire size is not on the price list.



V-Bar Cross Chain available @ extra cost

TIRE CHAIN  
SOLD / SET

**STANDARD TIRE CHAIN**

LIST PRICE EFFECTIVE SEPTEMBER 1, 2020

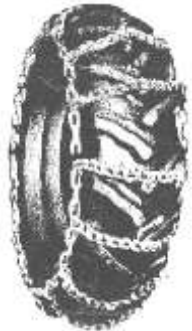
TIRE CHAIN  
SOLD / SET**CASE HARDENED CROSS-CHAIN 4-LINK SPACING****2-LINK SPACING****TIRE SIZE**

11.2-10 X 24
11.2-10 X 28
11.2-10 X 32
11.2-10 X 34
11.2 10 X 36
12.4-11X 24
12.4-11 X 28
12.4-11 X 32
12.4-11 X 36
12.4-11 X 38
13.6-12 X 24
13.6-12 X 28
13.6-12 X 36
13.6-12 X 38
14.9-13 X 24
14.9-13 X 28
14.9-13 X 30
14.9-13 X 38
16.9-14 X 24
16.9-14 X 26
16.9-14 X 28
16.9-14 X 30
16.9-14 X 32
16.9-14 X 34
16.9-14 X 38

**4-LINK SPACING****2-LINK SPACING**

TIRE SIZE	ITEM #	3/8" LIST	ITEM #	7/16" LIST	ITEM #	3/8" LIST	ITEM #	7/16"LIST
18.4-15 X 26	508165		xxxxxx		xxxxxx		xxxxxx	
18.4-15 X 30	508157		508159		xxxxxx		xxxxxx	
18.4-15 X 34	508158		xxxxxx		xxxxxx		xxxxxx	
18.4-15 X 38	508169		xxxxxx		508168		xxxxxx	

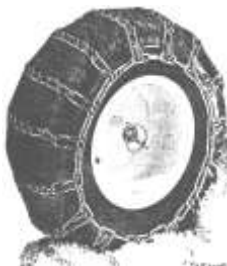
**SNOW BLOWER TIRE CHAIN 4mm 2-LINK SPACING**

ITEM #	TIRE SIZE
518116	10 x 2.75
518104	10.25 x 3.25
518106	12 x 4.00 x 6
518107	12 x 3.50 x 6
520001	4.10 x 3.50 x 4
520005	4.10 x 3.50 x 6
520004	13.00 x 5.00 x 6
518115	5.30 x 4.50 x 6
518118	12.50 x 4.50 x 6
520007	4.80 x 4.00 x 8
520006	13 x 6.50 x 6
520002	15 x 6.00 x 6
520011	13 x 4.00 x 6

**SNOW HOG - ZIG ZAG 4mm**

ITEM #	TIRE SIZE
518120	4.10 x 3.50 x 4
518121	5.3 x 6
518122	4.8 x 4.00 x 8
520012	15.00 x 6 x 6
518123	16 x 6.50 x 8
518124	13.5 x 500 x 6
520013	15 x 5 x 6
518128	4.10 x 6
518132	14 x 4 x 6

**ATV TIRE CHAIN V-Bar**

LIST PRICE EFFECTIVE SEPTEMBER 1, 2020

TIRE CHAIN  
SOLD / SET

ITEM #	TIRE SIZE	
	22 X 8 X 10 / 21 X 7 X 10	
	20 X 11 X 8	
525006	21 x 11 x 8	Ht 20 Rim 9 Hs 21
525001	22 X 11 X 8 / 22 X 12 X 8	14 cross chains
525003	25 x 8 x 12	14 cross chains
525004	25 x 10 x 12	14 cross chains
525015	25 X 12 X 9	
525005	24 x 11 x 10	14 cross chains
525020	25 X 13 X 9	Hr 25 Rim 10 Hs 22
520241	23 x 10.5 x 12	14 cross chains
525010	24 X 9 X 11	
518405	18 x 8.5 x 10	
520182	26 x 12 x 12	
520236	20 x 10 x 8	
520362	22 x 11 x 10	

**FORK-LIFT TIRE CHAIN****CASE HARDENED CROSS-CHAIN, 2-LINK SPACING.**

V-Bar available @ additional cost

ITEM #	TIRE SIZE	
508050	6.50 x 10	7/32"
508074	7.50 x 10	7/32"
508073	900 x 10	7/32"
508004	700 x 12	7/32"
508005	700 x 15	7/32"
508002	750 x 15 x 30 & 32	7/32"
508067	28 x 9 x 15	7/32"
508077	250 x 15	7/32"
508015	7.50 x 15 x 30	5/16"
508039	7 x 12	5/16"
508008	825 x 15	5/16"
508048	750 x 16	5/16"
508047	32 x 12.1 x 15	5/16"
508068	28 x 12.50 x 15	5/16"
508059	28 x 9 x 15	5/16"
508044	31 x 10.50 x 15	5/16"
508090	27 x 10.50 x 15	5/16"

**SKID STEER TIRE CHAIN**

ITEM #	TIRE SIZE	CHAIN SIZE
<b>2-LINK SPACING - CASE HARDENED</b>		
508128	10R 165	5/16"
508040	12R 165	5/16"
508127	14 x 17.5	5/16"
508126	15 x 19.5	5/16"

**4-LINK SPACING - CASE HARDENED**

ITEM #	TIRE SIZE	CHAIN SIZE
508027	10R 165	5/16
508054	12R 165	5/16
508143	14 x 17.5	5/16"
508094	15 x 19.5	5/16



**TIRE CHAIN PARTS & ACCESSORIES**

LIST PRICE EFFECTIVE SEPTEMBER 1, 2020



ITEM #	DESCRIPTION		
500039	5/32" /4mm	Zinc	Cross Chain
500055	7/32"	Zinc	Cross Chain
500053	7/32"	Case Hardened	Cross Chain
500061	1/4"	Case Hardened	Cross Chain
500081	5/16"	Case Hardened	Cross Chain
500096	3/8" /9.5mm	Case Hardened	Cross Chain
505115	7/16"	Case Hardened	Cross Chain
500130	1/2"	Case Hardened	Cross Chain
500205	5.5mm	Case Hardened	Cross Chain Studded
500208	5/16"	Case Hardened	Cross Chain Studded
500210	3/8"	Case Hardened	Cross Chain Studded
500211	7/16"	Case hardened	Cross Chain Studded
500213	1/2"	Case Hardened	Cross Chain Studded
500310	3/8"	Square Link	Cross Chain
500311	7/16"	Square Link	Cross Chain
500406	5.5 mm	Zinc	V-bar cross chain
500407	5/16"	Self colour	V-bar cross chain
501039	5/32 / 4mm	Zinc 30 mm link	Side Chain
501038	5/32 /4mm	Zinc	Side Chain
599999	3/16"	Zinc	Side Chain
501086	5/16"	Regular	Side Chain
501102	3/8"	Regular	Side Chain
501125	7/16"	Regular	Side Chain
501130	1/2"	Regular	Side Chain
505135	<b>Chain Pliers</b> - handle 26" long - overall 33" long		
505134	<b>Chain Pliers</b> for Lawn & Garden - overall length 13"		
503210	10mm	Hardened Connect /S-Link for 5/16 Tryqq cross chain	
503211	11mm	Hardened Connect /S-Link for 11/32 Tryqq cross chain	
503212	12mm	Hardened Connect /S-Link for 3/8 Tryqq cross chain	
503214	14mm	Hardened Connect /S-Link for 7/16 Tryqq cross chain	
505039	4mm	Cross Chain Hook	
505055	7/32"	Cross Chain Hook	
505063	1/4"	Cross Chain Hook	
505080	5/16"	Cross Chain Hook	
505062	3/8"	Cross Chain Hook	
505110	7/16"	Cross Chain Hook	
505130	1/2"	Cross Chain Hook	
503704	3/16"	Repair Link	
503706	1/4"	Repair Link	
503708	5/16"	Repair Link	
503710	3/8"	Repair Link	
503713	1/2"	Repair Link	
503402	1/8"	Quick Link	
503404	3/16"	Quick Link	
503406	1/4"	Quick Link	
503408	5/16"	Quick Link	
503410	3/8"	Quick Link	
503411	1/2"	Quick Link	
503009	#555	1/4" Side Chain Lock	
503015	#889	5/16" Side Chain Lock	
503014	#1011	3/8" Side Chain Lock	
503007	Wire Lock		
503016	#675	NA Lock - 5/16"	
503018	#714	NA Lock - 3/8"	
503004	#543	Lawn and Garden Outside Chain Lock	
503005	#500	Lawn and Garden Inside Lock	
503019	6-7mm	Lawn and Garden Inside Lock	
503008	7-9mm	Lawn and Garden Inside Lock	



**TRUCK TIRE CHAIN**

LIST PRICE EFFECTIVE SEPTEMBER 1, 2020

TIRE CHAIN  
SOLD / SET**SINGLE****TIRE SIZE 4-LINK**

10.00-20, 11-22.5

10-R-20, 11-R-22.5

10.00-22, 11-24.5

10-R-22, 11-R-24.5

11.00-20, 12-22.5

11-R-20, 12-R-22.5

12.00-20, 12-R-20

12-24.5, 11-R-22

11.00-22, 12-R-24.5

445/50R 22.5

11.00-22, 12-R-24.5, 445/50R 22.5 with Cams

**TIRE SIZE 2-LINK**

10 X 20

**ATV STYLE V-BAR** with Cam Tightener**TIRE SIZE 4-LINK**

10x20, 11x22.5

Other Sizes Available with V-Bar Cross Chain

**DUAL****TIRE SIZE 4-LINK**

10.00-20, 11-22.5

10-R-20, 11-R-22.5

10.00-22, 11-24.5

10-R-22, 11-R-24.5

11.00-20, 12-22.5

11-R-20, 12-R-22.5

12.00-20, 12-R-20

12-24.5, 11-R-22

11.00-22, 12-R-24.5

**TRIPLE****TIRE SIZE 4-LINK**

10.00-20, 11-22.5

10-R- 20, 11-R-22.5

10.00-22, 11-24.5

10-R- 22, 11-R-24.5

11.00-20, 12-22.5

11-R- 20, 12-R-22.5

12.00-20, 12-R-20

11.00-22, 12-R-24.5

11-R-22. 12-R-24.5

◆◆◆ OTHER SIZES AVAILABLE ◆◆◆

**CABLE TRUCK CHAINS****ITEM #**

508422

508414



## **TRUCK TIRE CHAIN**

For Radial & Bias Ply Tires

TIRE CHAIN  
SOLD / SET

ITEM #	TIRE SIZE	2-LINK 7/32
	5.6-15, 6.00-15, BR70-13, BR78-14, CR78-14, 175R14, 155R15, 165R15, 185/70R14, 175/70R14, 185/80R14, 185/80R13	
	CR70-13, 175R13, 185R13, 185/10R13, 195/70R13, 175/10R14, 165R14, 175/80R13	
	DR87-14, ER78-14, 185R14, 175R15, 195/70R14, 185/70R15, 205/70R13, 205/70R14, 195/75R14	
508049	205/70R14	
	FR70-14, FR78-14, GR78-14, FR78-15, 195R14, 185R15, 195R15, 215/70R14, 205/70R15, P205/75R14	
508299	GR70-14, HR70-14, GR70-15, HR78-14, GR78-15, HR78-15, 205R15, 225/70R15, 205/75R15, 215/70R15	
	215/75R15	
508081	225R15	
	LR78-15, L84-15, 215R15, 230R15, 225/75R15	
	H78-15, 8.00-R-16.5, 8.00-16.5, G78-G78-15, 225-75R14, 215-75R15	
508022	235-75R15,	
	215-85R16	
	L78-15, 8.75-16.5, 8.75-R-16.5, 235-15, 230-15, J78/JR78-15,	
	8.00-16.5 8.75-16.5	
	9.5-16.5, 7.50-R16-17, 9.50-R16.5, 7.50-16/17 6.00-16, 6.70-15	
	6.50-16, 6.50-R-16	
	7.00-15/16, 7.50-15, 9.50-16.5, 7.17.5, 8-17.5, 700-R-15, 9.50-16.5, 8-R-17.5, 215/85-R-16	
508036	235/85-R-16	
	7.50-16/17, 7.00-17/18, 7.50-18, 7-22.5, 8-19.5, 10-16.5, 7.00-20, 7.50-R-17, 8-R-19.5, 10-R-16.5, 255/85-r-16	
	7.00-20,	
	7.50-20, 8-22.5, 10-17.5 8.25-20, 9-22.5, 255/70-R-22.5, 8.25-R-20, 9-R-20.25	
520370	9.00-20, 10-22.5, 275/80-R-22.5, 9-R-20, 10-R-22.5	

**LOADER & GRADER**

LIST PRICE EFFECTIVE SEPTEMBER 1, 2020

TIRE CHAIN  
SOLD / SET**2-LINK SPACING****4-LINK SPACING****REGULAR LINK CROSS CHAIN** - 2 LINK SPACING (11mm)**TIRE SIZE**

13.00 x 24

14.00 x 24

16.00 x 24

17.5 x 25

20.5 x 25

23.5 x 25

**SQUARE LINK CROSS CHAIN**

2-LINK SPACING FOR BETTER TRACTION AND LONGER LIFE. (11mm)

**TIRE SIZE**

13.00 x 24

14.00 x 24

16.00 x 24

17.5 x 25

20.5 x 25

23.5 x 25

Also available with studded cross chain, and with 4-link spacing.

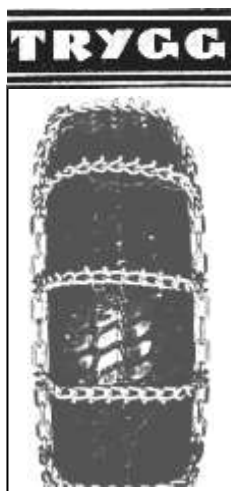
**STUDED CHAIN** FOR TRUCKS AND HEAVY EQUIPMENT**SINGLE - HEAVY DUTY 4-LINK****TIRE SIZE**

10.00x20, 11x22.5

10.00x22

11.00x20

425 x 65

**TRIPLE - HEAVY DUTY 4-LINK****TIRE SIZE**

10.00x20, 11x22.5

10.00x22, 11x24.5

11.00x20, 12x22.5

12 X 24

**SPECIAL ORDERS:** Three measurements are needed to make any size of tire chain

Tire Size appearing on the tire: \_\_\_\_\_

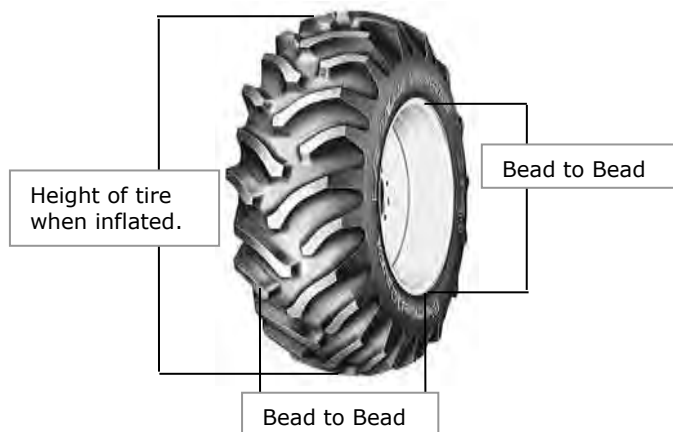
**"Bead to Bead"** - is a U shaped measurement

Start at bead of rim on one side of tire, up the sidewall, across the tread, down the sidewall, to the bead of the other side of tire.

**RING CHAIN**

LIST PRICE EFFECTIVE APRIL 12/21

TIRE CHAIN  
SOLD / SET**FIXED RING**

ITEM #	TIRE SIZE	CHAIN SIZE
530150	16.9 x 30	9/16"
530153	18.4 x 34	5/8"
530154	23.1 x 26	5/8"
530156	24.5 x 32	5/8"
530160	24.5 x 32	3/4"
530162	30.5 x 32	3/4"

**MULTI-RING**

ITEM #	TIRE SIZE	CHAIN SIZE
530165	18.4 x 34	5/8"
530167	23.1 x 26	5/8"
530168	24.5 x 32	5/8"
530177	24.5 x 32	3/4"
530170	30.5 x 32	5/8"
530179	30.5 x 32	3/4"

**STUDED SKIDDER CHAIN****DOUBLE DIAMOND**

ITEM #	TIRE SIZE	CHAIN SIZE
530185	18.4 x 34	5/8"
530186	23.1 x 26	5/8"
530187	24.5 x 32	5/8"
530189	30.5 x 32	5/8"

CHAIN COLOURS MAY NOT BE AS SHOWN



## HITCH ACCESSORIES

PRICE EFFECTIVE SEPTEMBER 1, 2020

### HITCH BALLS FORGED, CHROME PLATED HIGH QUALITY, LOAD RATED

ITEM #	VESC CLASS	MAX. LOAD	BALL SIZE	THREAD DIA.	STUD LENGTH
385401	I	2000	1-7/8	3/4	1-3/4
385402	II	3500	2	3/4	1-3/4
385403	III	5000	2	1	2-1/8
385404	IIII	7500	2-5/16	1-1/4	2-1/8



### ANCHOR POINTS (FOR PICK UP TRUCKS)

ITEM #	TYPE	FINISH
381001	Eyebolt	Zinc Plated
381002	Decorative	Chrome Plated

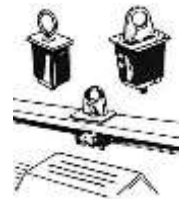

### HITCH PINS (PLASTIC COATED)

ITEM #	DIA.	USABLE LENGTH
384501	1/2	3-5/8
384502	5/8	4
384503	5/8	5-1/2
384504	3/4	4
384505	3/4	6-1/2
384506	7/8	6-1/2
384507	1	7-1/2
384508	1-1/8	8-1/2
384509	1-1/4	8-1/2
384510	1-1/2	8-1/2

Made of high tensile steel.  
One-piece forged pin w/  
extra large head.  
Welded, red plastic-coated handle.



Baked black painted finish on pin.  
Includes pin.  
Heat treated to28 - 35 rockwell.

### HITCH PINS (DROP FORGED)

ITEM #	DIA.	USABLE LENGTH
384604	3/4	4
384607	5/8	6
384608	3/4	6-1/4
384609	7/8	6-1/2
384610	1	6-3/4
384611	1-1/8	7
384612	1-1/4	7

Forged from high tensile steel.  
One piece, drop forged pin  
is painted and baked bright red.



Zinc plated spring wire handle.  
Includes hair pin.  
Heat treated to28 - 35 rockwell

### HITCH PINS (WITH CHAIN)

ITEM # /CLIP	DIA.	USABLE LENGTH	ITEM # /CHAIN
384701	1/2	4-1/4	384801
384702	5/8	4-1/4	384802
384703	5/8	6-1/4	384803
384704	3/4	4-1/4	384804
384705	3/4	6-1/4	
384706	7/8	4-1/4	384806
384707	7/8	6-1/4	384807
384708	1	4-1/4	
384709	1	6-1/4	

Forged from1040 steel.  
Zinc plated, pin  
Spring-wire handle.  
Includes Hair clip cotter pin.



### HITCH PINS WITH LOCK HANDLE

ITEM #	PIN DIA.	COLLAR DIA.	USABLE LENGTH
387120	.50"	1"	4.25"
387121	.62"	1.13"	4.25"
387122	.75"	1.25"	4.25"
387123	.75"	1.25"	6.25"
387124	.87"	1.38"	6.25"
387125	1"	1.50"	6.25"

Made of 1040 Steel  
Zinc plated



### HITCH PINS (BENT)

ITEM #	DIA.	LENGTH
385001	1/2	3
385002	5/8	3
385003	3/4	3-1/2
385011	7/8	4.5

One-piece, high carbon, steel pin.  
Zinc plated. Includes clip.



**LYNCH PINS**

ITEM #	A		B		C	
	IN.	MM.	IN.	MM.	IN.	MM.
385501	3/16	4	1-1/8	28	13/8	35
385502	1/4	6	1-7/16	36.5	1-3/4	44.5
385503	5/16	8	1-7/16	36.5	1-3/4	44.5
385505	3/8				1-3/4	
385507	7/16	11	1-13/32	36	1-3/4	44.5
385508	7/16	11	1/17/16	36.5	2	51
WITH HEAVY DUTY RING						
385510	7/16	11	1-13/32	36	1-3/4	44.5

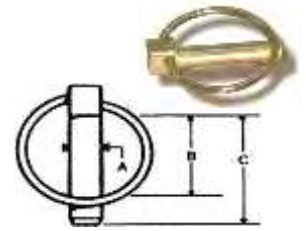
**HAIR CLIP COTTER (MADE OF SPRING STEEL)**

ITEM #	A		PIN SIZE		B	
	in.	mm	in.	mm	in.	mm
383501	5/64	2	1/4-7/16	6-11	1-5/8	42
383502	3/32	2.5	5/16-1/2	8-12	1-11/16	43
383503	1/8	3	3/8-11/16	10-18	2-1/2	64
383504	5/32	4	1/2-7/8	12-22	3	76
383505	11/64	4.5	3/8-11/16	10-18	4-1/8	105
383506	13/64	5	5/8-1-1/16	16-27	4	100
383507	1/4	6	3/4-1-1/4	19-32	4-1/2	110
383508	9/32	7	1-1-1/2	25-28	6	152

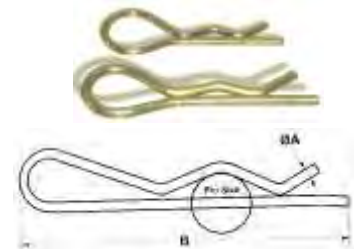
**SAFETY PINS**

ITEM #	LENGHT-A	LENGHT-B	WIDTH -C
387301	1-9/16"	1-5/16"	3/8"
387302	1-3/4"	1-1/16"	3/8"
387303	2-3/4"	1-11/16"	5/8"
387304	4-3/8"	2-13/16"	13/16"
387305	5-3/4"	3-3/4"	1-1/8"

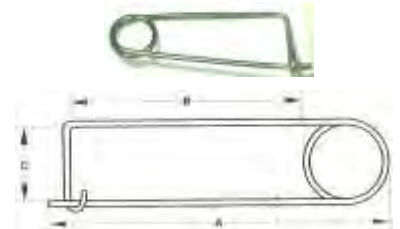
**SNAPPER PINS**

ITEM #	SIZE	SHAPE
387104	1/4 x 1-3/8	Round
387114	1/4 x 2-1/2	Round
387108	5/16 x 2-1/4	Round
387109	5/16 x 2-1/4	Square
387110	3/8 x 2 -1/4	Round
387113	3/8 x 2-1/2	Square
387106	1/4 x 2-3/4	Round
387112	1/4 x 2-3/4	Square
387115	1/4 x 2-1/2	Square

**LIFT ARM PINS**

ITEM #	CAT.	TYPE	USABLE	PIN		THREAD	OVERALL
				DIA.	DIA.		
386001	0	Adj.	Adj.	5/8	5/8		4
386002	1	Adj.	Adj.	7/8	7/8		5-5/16
386003	1	Forged	1-3/4	7/8	7/8		5-1/2
386006	1 to 2	Adj.	Adj.	1-1/8	7/8		5-3/16
386007	1 to 2	Forged	1-3/4	1-1/8	7/8		5-1/4
386009	2 to 1	Forged	1-3/4	7/8	1-1/8		5-3/4
386010	1 & 2	Forged	2-1/16	7/8&1-1/8	1		8
386011	2	Adj.	Adj.	1-1/8	1-1/8		6-1/4
386012	2	Forged	1-3/4	1-1/8	1-1/8		6-1/4
386013	2 to 3	Forged	1-7/8	1-7/16	1-1/8		5-7/8
386014	3	Forged	2	1-7/16	1-3/8		5-7/8
386015	2	Clevis	4-7/16	1-1/8			6-1/2

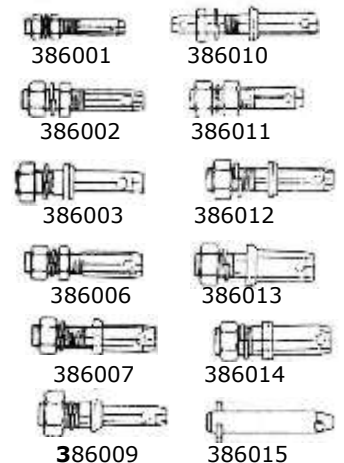

**DRAWBAR (ONE PIECE)**

PRICE EFFECTIVE SEPTEMBER 1, 2020

ITEM #	L CAT.	LIFT ARM		HOLE DIA.	PIN DIA.	THICKNESS	WIDTH
		SPACING	# OF HOLES				
383001	1	20	7	3/4	7/8	1	2-1/2
383002	1	26	11	3/4	7/8	1	2-1/2
383003	2	26	11	3/4	1-1/8	1-1/4	3
383004	2	32	13	3/4	1-1/8	1-1/4	3

**TOP LINKS**

ITEM #	CAT	PIN TYPE	THREAD		ADJUSTMENT		
			HOLES	DIA.	BODY	Hole	Center
387601	0	Std	5/8	3/4	7-1/2	10-3/4	16-3/8
387602	1	Std	3/4	1-1/8	13	17-1/2	26
387603	1	Std	3/4	1-1/8	16	20-1/2	29
387604	1	Std	3/4	1-1/8	20	24-1/2	33
387605	1&2	Std	3/4&1	1-1/8	16	20-3/4	31
387606	1&2	Std	3/4&1	1-1/8	20	24-3/4	35
387608	2	Std	1	1-1/8	16	21	33
387609	2	Std	1	1-1/8	20	25	37
387612	3	HD	1-1/4	1-3/8	19	25-1/2	36-1/2

**TOP LINK PINS**

ITEM #	CAT.	DIA.	USABLE	OVERALL
387501	0	5/8	2-3/4	4-7/16
387502	1	3/4	2-3/4	4-1/2
387503	1	3/4	3-7/8	5-1/2
387504	1	3/4	4-3/4	6-3/8
387505	2	1	3-9/16	5-1/4
387506	2	1	4-5/16	6
387507	3	1-1/4	4-7/16	6-1/2

**REPLACEMENT ENDS (TOP LINKS)**

ITEM #	THREAD	CAT.	PIN		THREAD	
			HOLES	DIA.	DIA.	DIA.
387702	RH	1	3/4	1-1/8	1-1/8	1-1/8
387703	LH	2	1	1-1/8	1-1/8	1-1/8
387704	RH	2	1	1-1/8	1-1/8	1-1/8
387705	LH	2 HD	1	1-1/4	1-1/4	1-1/4
387706	RH	2 HD	1	1-1/4	1-1/4	1-1/4
387707	LH	3 HD	1-1/4	1-3/8	1-3/8	1-3/8
387708	RH	3 HD	1-1/4	1-3/8	1-3/8	1-3/8



387650 Hyd. Top Link Adapter Kit Cat. II

ITEM #	DESCRIPTION	H.P.	SPLINE	SPLINE	PTO	OVERALL
386801	Forged Increaser	70	1-1/8 x 6	1-3/8 x 6	1-1/8	3
386802	Sleeve Increaser Fits all except Ford	70	1-1/8 x 6	1-3/8 x 6	0	2-1/4
386803	Sleeve Increaser	70	1-1/8 x 6	1-3/8 x 6	0	1-7/8
386804	Forged Increaser	70	1-1/8 x 6	1-3/8 x 6	2-1/2	4-5/8
386805	Forged Reducer	70	1-3/8 x 6	1-3/8 x 6	2-3/4	5-3/8
386806	Forged Extender	70	1-3/8 x 6	1-3/8 x 6	3	5-3/8
386808	21 to 6 Splined OR 1000 to 540 RPM	70	1-3/8x21	1-3/8x6	4-1/8	6-3/8
386809	QR 6 Splined Extender	70	1-3/8 x 6	1-3/8 x 6	4-1/8	3-3/8
386810	QR 21 Splined Extender	70	1-3/8 x 21	1-3/8 x 21	4-1/8	5-7/8
386813	20 to 6 Splined H.D. Adaptor	150	1-3/4 x 20	1-3/8 x 6	5	7-7/8
386815	20 to 21 Splined H.D. Adaptor	150	1-3/4 x 20	1-3/8 x 21	5-1/2	7-7/8



PRICE EFFECTIVE SEPTEMBER 1, 2020

**BALL ENDS (LOWER LINK WELD-ON)**

ITEM #	A		B		C		D		E		F	
	in.	mm	in.	mm	in.	mm	in.	mm	in.	mm	in.	mm
381806	2-3/4	70	7/8	22	2-3/8	60	5/8	16	1-3/8	35	2-5/8	66
381807	3-1/8	80	1	25	2-3/4	70	3/4	19	1-1/2	38	3-1/4	82
381808	3-1/8	80	1-1/8	28.5	2-3/4	70	3/4	19	1-1/2	38	3-1/4	82

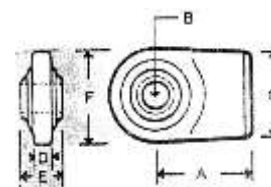
**LIFT ARM SOCKETS (NOT PLATED)**

ITEM #	DESCRIPTION				
387907	H.D. Cat. 1 & 2	.7/8 & 1-1/8"	1-3/4"	1-3/8"	3-1/8"
387911	H.D. Cat. 2.	1-1/8"	1-3/4"	1-3/8"	3-1/8"
387913	Standard Cat. 3	1-7/16"	1-3/4"	1-11/32"	3-1/2"

**TOP LINK SOCKETS (NOT PLATED)**

ITEM #	DESCRIPTION
381501	Cat. 0
381502	Cat. I
381504	Cat. II
381506	Cat. III

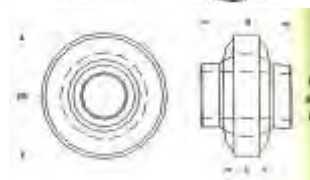
**PIN KIT**

ITEM #	DESCRIPTION	PIN DIA.	USABLE	OVERALL
386502	Pin w/2 Clips	1	2-3/4	3 1/2

**STABILIZER PIN**

ITEM #	PIN DIA.	THREAD DIA.	USABLE	OVERALL
387002	7/8"	5/8"	3/8"	2-5/8"
387020	7/8"	no thread	3/8"	1-1/2

**BUSHINGS (ZINC PLATED)**

ITEM #	TYPE	CATEGORY	I.D.	O.D.	OVERALL
381701	Top Link	1-2	3/4	1	2
381702	Top Link	1-2	3/4	1	1-5/8
381703	Top link	2-3	1	1-1/4	2
381704	Lift Arm	1-2	7/8	1-1/8	1-3/4
381705	Lift Arm	1-2	7/8	1-1/8	1-3/8
381706	Lift Arm	2-3	1-1/8	1-7/16	1-3/4
381707	Lift Arm		1-1/8		2-3/4
381708	Lift Arm	2-3	1-1/8	1-7/16	3-1/4
381709	Lift Arm	2-3	1-1/8	1-7/16	2-1/2

**HITCH BUSHING (ZINC PLATED)**

ITEM #	CATEGORY	I.D.	O.D.
385301	2 to 3	1-1/8	1-7/16

**RATCHET JACK**

ITEM #	DESCRIPTION	THREAD	CLEVIS	ADJ.
		DIA.	PIN DIA.	
386501	Ratchet Jack w/Pins & Handle	1-1/4	1	20 - 28

**TRACTOR DRAWBAR GRAB HOOK**

ITEM #	PIN DIAMETER	W.L.L. LBS.
387801	3/4	9500

**CLEVIS**

ITEM #	TYPE	PIN	BODY	W.L.L.
		SIZE	DIA.	LBS.
382501	Straight	1/2	5/8	7,000
382502	Twist	1/2	5/8	7,000
382503	Straight	5/8	3/4	14,000
382504	Twist	5/8	3/4	14,000
382505	Straight	3/4	7/8	18,000
382506	Twist	3/4	7/8	18,000
382507	Straight	7/8	15/16	22,000
382508	Twist	7/8	15/16	22,000
382509	Straight	1	1	25,000
382510	Twist	1	1	25,000

