

PRORENFORT

Le pro de la distribution

The pro of distribution

Changer l'aspect de vos lumières

Change the look of yours lights



Key Markets Served...



Commercial/Fleets



Trailers

Emergency Vehicles



Marine



Recreational Vehicles

Table of contents

Stop/Tail/Turns	pg 2 - 11
Over 80" ID Bars	pg 12 - 13
Reverse Lamps	pg 14 - 15
License Plate Lights	pg 16 - 17
Sidemarkers, Fender Lights, and Reflectors	pg 18 - 26
Area & Accent Lighting	pg 27 - 45
Emergency Vehicle Exterior Lighting	pg 46 - 51
Accessories	pg 52
Lighting Specifications	pg 53 - 57
Part Number Index	pg 58 - 80

6" Oval LED Stop/Tail/Turn Model T600

Grommet Mount



*Vertical and horizontal styles

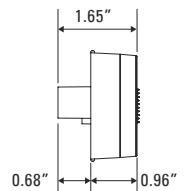
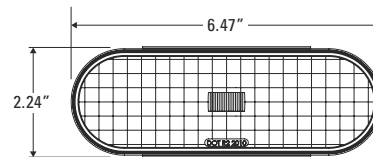
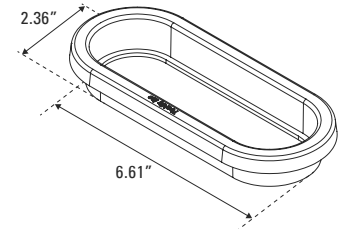

Features



- Fits all industry standard 6" oval grommet mount applications
- TPE grommet, offering superior toughness and chemical resistance
- Can be purchased for horizontal or vertical position mounting - separate part numbers
- TecSeal Urethane Potting - Guaranteed Circuit Board Protection
- IP68 Rated - Dust and water proof with hermetic seal
- Durable impact resistant lens
- Meets all FMVSS 108 requirements for wide and narrow vehicles
- Reliable performance over 100,000 hours
- Also available in T610 surface mount version and T620 flange mount



Part No.	Part Description	Amps	Color	Std Pack
T60-RRHP-1	6" Oval Red STT Horiz. Grommet Mount Red Lens Pig Tail	0.17A - 0.23A		140
T60-RRVP-1	6" Oval Red STT Vertical Grommet Mount Red Lens Pig Tail			140
T60-RCHP-1	6" Oval Red STT Horiz. Grommet Mount Clear Lens Pig Tail	0.10A - 0.14A		140
T60-RCVP-1	6" Oval Red STT Vertical Grommet Mount Clear Lens Pig Tail			140
T60-AAHP-1	6" Oval Amber Turn Horiz. Grommet Mnt Amber Lens Pig Tail	0.17A - 0.23A		140
T60-AAVP-1	6" Oval Amber Turn Vertical Grommet Mnt Amber Lens Pig Tail			140
T60-ACHP-1	6" Oval Amber Turn Horiz. Grommet Mount Clear Lens Pig Tail	0.28A - 0.36A		140
T60-ACVP-1	6" Oval Amber Turn Vertical Grommet Mnt Clear Lens Pig Tail			140
T60-WCHP-1	6" Oval White Light Horiz Grommet Mount Clear Lens Pig Tail	0.21A - 0.27A		140

For full list of part numbers see **pg 77**

6" Oval LED Stop/Tail/Turn Model T610



* Optional chrome trim ring



* Vertical and horizontal styles

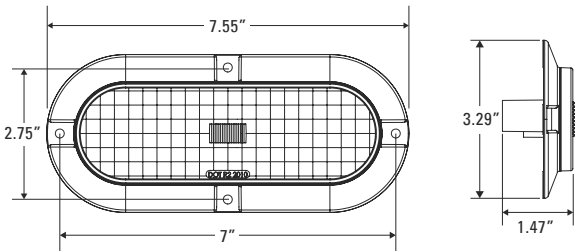

Features



- Surface mount 6" oval - fits all industry standard applications
- Can be purchased for horizontal or vertical position mounting - separate part numbers
- TecSeal Urethane Potting - Guaranteed Circuit Board Protection
- IP68 Rated - Dust and water proof with hermetic seal
- Durable impact resistant lens
- Meets all FMVSS 108 requirements for wide and narrow vehicles
- Reliable performance over 100,000 hours
- Also available in T600 grommet mount version and T620 flange mount

Part No.	Part Description	Amps	Color	Std Pack
T61-RRHP-1	6" Oval Red STT Horiz. Surface Mount Red Lens w/Pig-Tail	0.17A - 0.23A		140
T61-RRVP-1	6" Oval Red STT Vertical Surface Mount Red Lens Pig Tail			140
T61-RCHP-1	6" Oval Red STT Horiz. Surface Mount Clear Lens w/Pig-Tail	0.10A - 0.14A		140
T61-RCVP-1	6" Oval Red STT Vertical Surface Mount Clear Lens Pig Tail			140
T61-AAHP-1	6" Oval Amber Turn Horiz. Surface Mount Amber Lens Pig Tail	0.17A - 0.23A		140
T61-AAVP-1	6" Oval Amber Turn Vertical Surface Mount Amber Lens Pig Tail			140
T61-ACHP-1	6" Oval Amber Turn Horiz. Surface Mount Clear Lens Pig Tail	0.28A - 0.36A		140
T61-ACVP-1	6" Oval Amber Turn Vertical Surface Mnt Clear Lens Pig Tail			140
T61-WCHP-1	6" Oval White Light Surface Mount Pig Tails	0.21A - 0.27A		140

For full list of part numbers see **pg 77**

6" Oval LED Stop/Tail/Turn Model T620

Flange Mount



*Vertical and horizontal styles

Features



- Flange mount 6" oval - fits all industry standard applications
- Can be purchased for horizontal or vertical position mounting - separate part numbers
- TecSeal Urethane Potting - Guaranteed Circuit Board Protection
- IP68 Rated - Dust and water proof with hermetic seal
- Durable impact resistant lens
- Meets all FMVSS 108 requirements for wide and narrow vehicles
- Reliable performance over 100,000 hours
- Also available in T600 grommet mount version and T610 surface mount

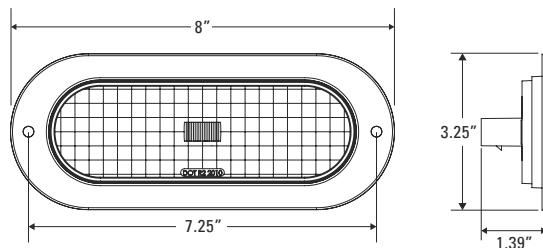

Part No.	Part Description	Amps	Color	Std Pack
T62-RRHA-1	Red Flange Mount Horizontal Oval Tail Red Lens Amp Connector	0.17A - 0.23A		120
T62-RRVA-1	Red Flange Mount Vertical Oval Tail Red Lens Amp Connector			120
T62-RCHA-1	Red Flange Mount Horizontal Oval Tail Clear Lens Amp Connector	0.10A - 0.14A		120
T62-RCVA-1	Red Flange Mount Vertical Oval Tail Clear Lens Amp Connector			120
T62-AAHA-1	Amber Flange Mount Horizontal Oval Amber Lens Amp Connector	0.17A - 0.23A		120

For full list of part numbers see **pg 78**

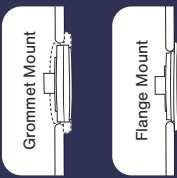

4" Round LED Stop/Tail/Turn Model T400



* Flange Mount



* Flange Mount with SS trim

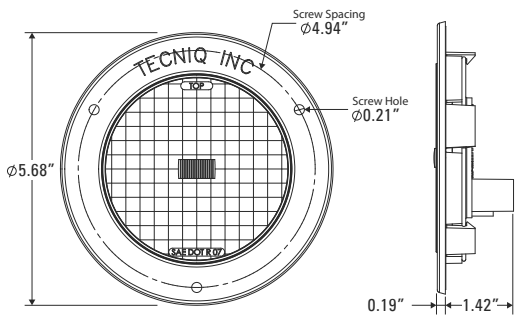
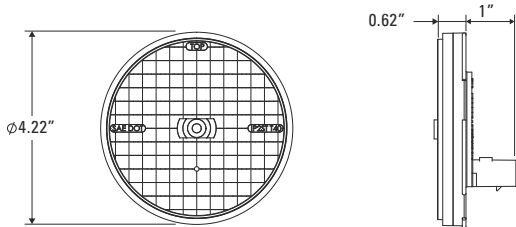
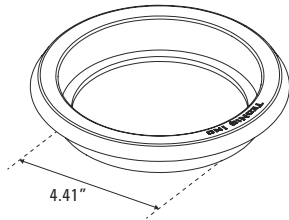

Features



- Industry standard 4" round Stop/Tail/Turn light
- Offered in our grommet or flange mount styles
- TecSeal Urethane Potting - Guaranteed Circuit Board Protection
- IP68 Rated - Dust and water proof with hermetic seal
- Durable impact resistant lens
- Meets all FMVSS 108 requirements for wide and narrow vehicles
- Reliable performance over 100,000 hours

Part No.	Part Description	Amps	Color	Std Pack
T40-RR0P-1	4" Round STT Lamp Red Lens Grommet Mount w/Pig Tail	0.17A - 0.23A		100
T40-RRFP-1	4" Round STT Red Lens Flange Mount w/Pig Tail			100
T40-RC0P-1	4" Round STT Lamp Clear Lens Grommet Mount w/Pig Tail	0.10A - 0.14A		100
T40-RCFP-1	4" Round STT Clear Lens Flange Mount w/Pig Tail			100
T40-AA0P-1	4" Round Amber Turn Lamp Amber Lens Grommet Mount w/Pig Tail	0.17A - 0.23A		100
T40-AAFP-1	4" Round Amber Turn Lamp Amber Lens Flange Mount w/Pig Tail			100
T40-AC0P-1	4" Round Amber Turn Lamp Clear Lens Grommet Mount w/Pig Tail	0.26A - 0.34A		100
T40-ACFP-1	4" Round Amber Turn Lamp Clear Lens Flange Mount w/Pig Tail			100

For full list of part numbers see **pg 75**

6" Oval LED Stop/Tail/Turn Model T660

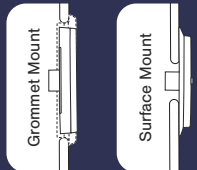

* Can be mounted at any angle



* Surface mount with chrome trim



Features



- Smooth surface, great looking Stop/Tail/Turn Light
- Durable impact resistant lens
- Fits all industry standard 6" oval applications
- Available in grommet, surface, or flange mount
- Can be mounted horizontal, vertical, or at any angle
- TecSeal Urethane Potting - Guaranteed Circuit Board Protection
- Excellent UV Resistance - Automotive exterior lighting grade polycarbonate
- IP68 Rated - Dust and water proof with hermetic seal
- Meets all FMVSS 108 requirements for wide and narrow vehicles
- Reliable performance over 100,000 hours

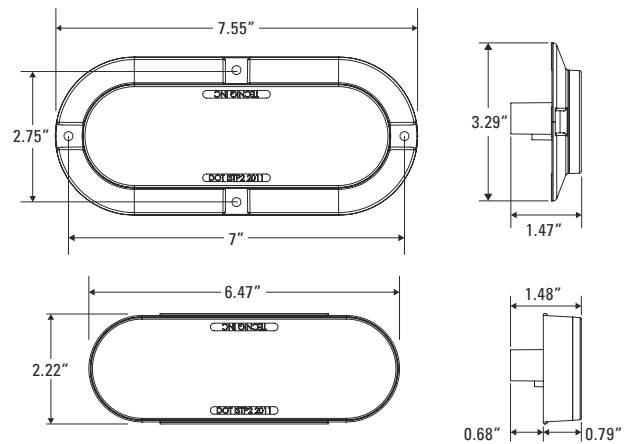
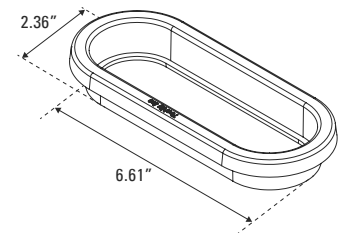

Part No.	Part Description	Amps	Color	Std Pack	
T66-RR0P-1	6" Oval 6 LED STT Grommet Mount Red Lens Pigtail	0.17A - 0.28A			140
T66-RRSP-1	6" Oval 6 LED STT Surface Mount Red Lens Pig Tail				140
T66-RC0P-1	6" Oval 6 LED STT Grommet Mount Clear Lens Pigtail	0.12A - 0.16A			140
T66-RCSP-1	6" Oval 6 LED STT Surface Mount Clear Lens Pigtail				140
T66-AA0P-1	6" Oval 6 LED Turn Dual Intensity Grommet Mount Amber Lens Pigtail	0.17A - 0.28A			140
T66-AASP-1	6" Oval 6 LED Turn Dual Intensity Surface Mount Amber Lens Pigtail				140
T66-AC0P-1	6" Oval 6 LED Turn Dual Intensity Grommet Mount Clear Lens Pigtail	0.12A - 0.16A			140

For full list of part numbers see **pg 78**

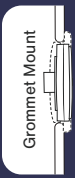

NEW

4" Round Hi Visibility LED STT Model T460

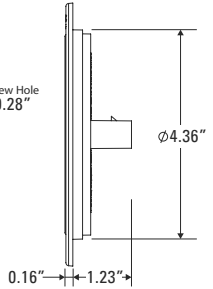
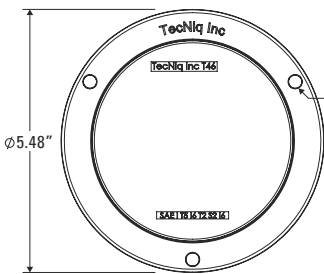
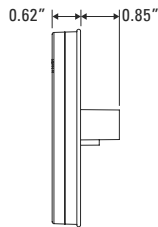
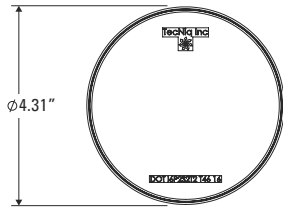
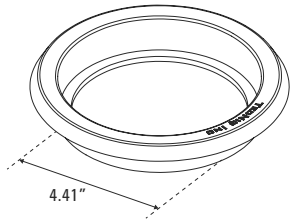

Features



- Smooth surface, great looking Stop/Tail/Turn Light
- Durable impact resistant lens
- Fits all industry standard 4" round applications
- Available in grommet or flange mount
- TecSeal Urethane Potting - Guaranteed Circuit Board Protection
- Excellent UV Resistance - Automotive exterior lighting grade polycarbonate
- IP68 Rated - Dust and water proof with hermetic seal
- Meets all FMVSS 108 requirements for wide and narrow vehicles
- Reliable performance over 100,000 hours
- Lifetime Warranty

Part No.	Part Description	Amps	Color	Std Pack
T46-RR0T-1	Hi Visibility 4" Round STT Red Lens Grommet Mount Tri-Pole	0.11A - 0.15A		100
T46-RRFT-1	Hi Visibility 4" Round STT Red Lens Flange Mount Tri-Pole			100
T46-RC0T-1	Hi Visibility 4" Round STT Clear Lens Grommet Mount Tri-Pole			100
T46-RCFT-1	Hi Visibility 4" Round STT Clear Lens Flange Mount Tri-Pole			100
T46-AA0T-1	Hi Visibility 4" Round Amber Turn Amber Lens Tri Pole Connector	0.14A - 0.18A		100
T46-AC0T-1	Hi Visibility 4" Round Amber Turn Clear Lens Tri Pole Connector			100

For full list of part numbers see **pg 76**

4" Round LED High Visibility STTR Model T450

NEW

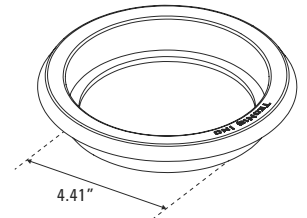

Features



- Save time and money with our new combination Stop/Tail/Turn and Reverse Light
- Fits all standard 4" round applications
- Available in grommet or flange mount
- High intensity function only draws 0.13A at 12VDC
- Reverse function uses an additional 0.3A
- TecSeal Urethane Potting - Guaranteed Circuit Board Protection
- Excellent UV Resistance - Automotive exterior lighting grade polycarbonate
- IP68 Rated - Dust and water proof with hermetic seal
- Meets all FMVSS 108 requirements for wide and narrow vehicles
- Reliable performance over 100,000 hours
- Lifetime Warranty

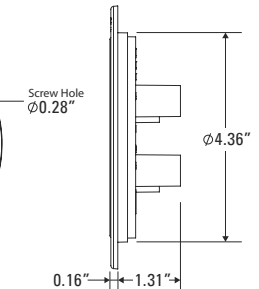
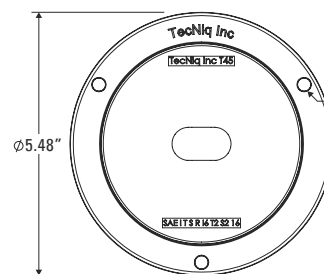
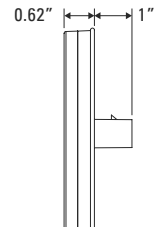
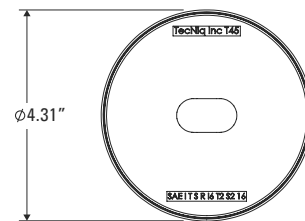

Part No.	Part Description	Amps	Color	Std Pack
T45-RW0P-1	4" Round STTR Red Lens Grommet Mount Pig-Tail	0.11A - 0.15A +0.3A (reverse)		100
T45-RWFP-1	4" Round STTR Red Lens Flange Mount Pig-Tail			100
T45-RC0P-1	4" Round STTR Clear Lens Grommet Mount Pig-Tail			100
T45-RCFP-1	4" Round STTR Clear Lens Flange Mount Pig-Tail			100

For full list of part numbers see **pg 76**

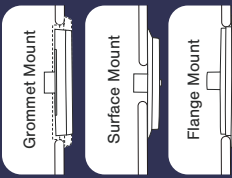

NEW

6" Oval LED High Visibility STTR Model T700



* Available as surface mount



* Can be mounted at any angle

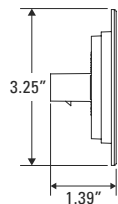
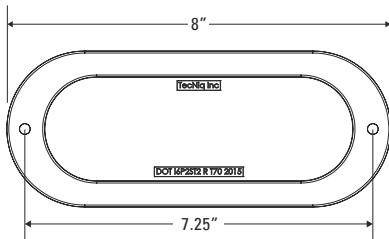
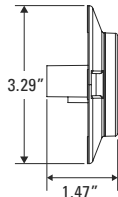
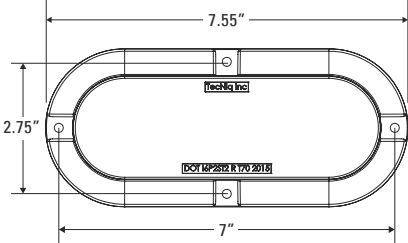
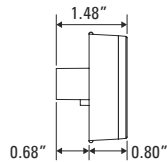
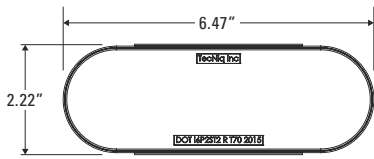
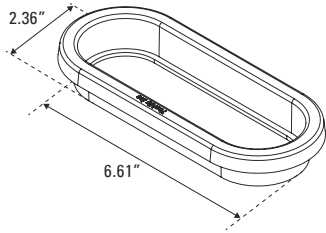

Features



- Save time and money with our new combination Stop/Tail/Turn and Reverse Light
- Fits all standard 6" oval applications
- 360° optics allow lights to be mounted at any angle
- Available in grommet, surface, or flange mount
- High intensity function only draws 0.14A at 12VDC
- Reverse function uses an additional 0.3A
- Lifetime Warranty

Part No.	Part Description	Amps	Color	Std Pack
T70-RW0P-1	6" Oval Stop Tail Turn Reverse Grommet Red Lens 2 Pigtail Connectors	0.41A - 0.50A +0.3A (reverse)		140
T70-RWFP-1	6" Oval Stop Tail Turn Reverse Flange Red Lens 2 Pigtail Connectors			140
T70-RWSP-1	6" Oval Stop Tail Turn Reverse Surface Red Lens 2 Pigtail Connectors			140
T70-RC0P-1	6" Oval Stop Tail Turn Reverse Grommet Clear Lens 2 Pigtail Connectors			140
T70-RCFP-1	6" Oval Stop Tail Turn Reverse Flange Clear Lens 2 Pigtail Connectors			140
T70-RCSP-1	6" Oval Stop Tail Turn Reverse Surface Clear Lens 2 Pigtail Connectors			140

For full list of part numbers see **pg 79**

4" LED Trailer Light Model T850

Features



- Multi-Function 4" box tail light
- TecSeal Urethane Potting - Guaranteed Circuit Board Protection
- IP68 Rated - Dust and water proof with hermetic seal
- Durable impact resistant lens
- Meets all FMVSS 108 requirements for narrow and wide vehicles
- Reliable performance over 100,000 hours
- Fits standard mounting as a direct replacement
- Functions include : Stop • Turn • Tail • Clearance • Side marker • Side Reflector • Rear Reflector • License Plate Light (Left)

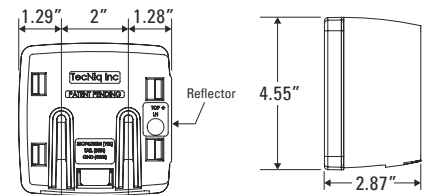

Part No.	Part Description	Amps	Color	Std Pack
T85-RRLP-1	8 Function 4" Box Tail Light Left Side Pig Tail	0.15A - 0.19A	 	32
T85-RRRP-1	7 Function 4" Box Tail Light Right Side Pig Tail	0.05A - 0.09A	 	32

For full list of part numbers see **pg 80**

6" LED Trailer Light Model T860

Features



- Multi-Function 6" box tail light
- TecSeal Urethane Potting - Guaranteed Circuit Board Protection
- IP68 Rated - Dust and water proof with hermetic seal
- Durable impact resistant lens
- Meets all FMVSS 108 requirements for narrow and wide vehicles
- Reliable performance over 100,000 hours
- Fits standard mounting as a direct replacement
- Functions include : Stop • Turn • Tail • Clearance • Side marker • Side Reflector • Rear Reflector • License Plate Light (Left)

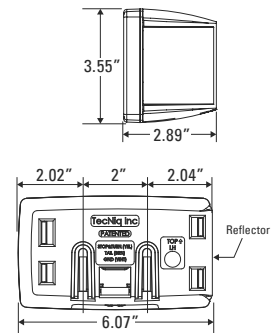

Part No.	Part Description	Amps	Color	Std Pack
T86-RRLP-1	8 Function 6" Box Light Left Side Pig Tail	0.14A - 0.17A	 	32
T86-RRRP-1	7 Function 6" Box Light Right Side Pig Tail	0.06A - 0.08A	 	32

For full list of part numbers see **pg 80**

8" LED Trailer Light Model T800

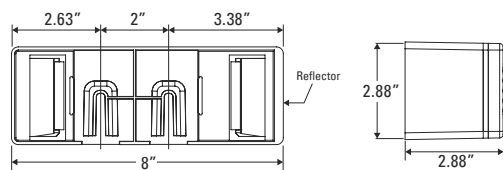

Features



- Multi-Function 8" low profile tail light
- TecSeal Urethane Potting - Guaranteed Circuit Board Protection
- IP68 Rated - Dust and water proof with hermetic seal
- Durable impact resistant lens
- Meets all FMVSS 108 requirements for narrow and wide vehicles
- Reliable performance over 100,000 hours
- Fits standard mounting as a direct replacement
- Functions include : Stop • Turn • Tail • Clearance • Side marker • Side Reflector • Rear Reflector • License Plate Light (Left)

Part No.	Part Description	Amps	Color	Std Pack
T80-RRLP-1	8 Function 8" Box Tail Light Left Side Pig Tail	0.14A - 0.20A	 	32
T80-RRRP-1	7 Function 8" Box Tail Light Right Side Pig Tail	0.06A - 0.09A	 	32

For full list of part numbers see **pg 80**

Stop/Tail/Turn Model T100

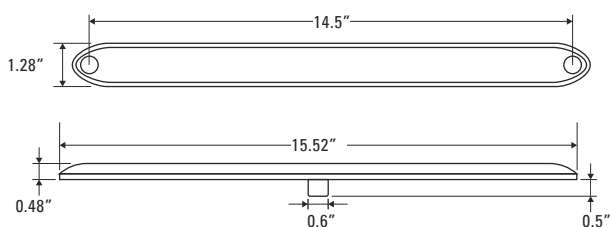
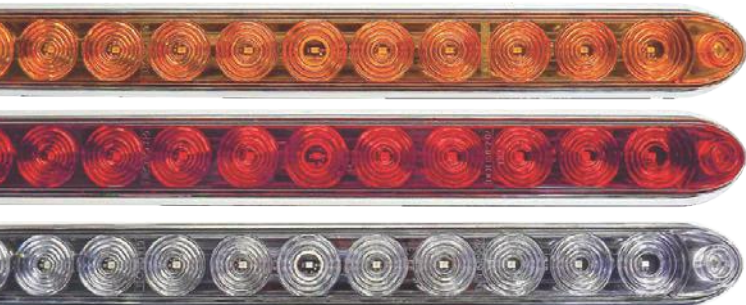











* Optional chrome bezel available

Features



- Meets all FMVSS 108 requirements for wide and narrow vehicles
- IP68 Rated - Dust and water proof with hermetic seal
- TecSeal Urethane Potting - Guaranteed Circuit Board Protection
- Durable impact resistant lens
- Excellent UV Resistance - Automotive exterior lighting grade polycarbonate
- Reliable performance over 100,000 hours
- Can be mounted horizontal, vertical, or at any angle

Part No.	Part Description	Amps	Color	Std Pack
T10-RR00-1	Red Low Profile STT Red Lens	0.22A - 0.29A	 	100
T10-RC00-1	Red Low Profile STT Clear Lens	0.11A - 0.23A	 	100
T10-AA00-1	Amber Low Profile Turn Sidemarker Amber Lens	0.17A - 0.23A	 	100
T10-AC00-1	Amber Low Profile Turn Sidemarker Clear Lens		 	100
T10-LC00-1	Low Profile Auxiliary Light	0.31A - 0.38A	 	100

For full list of part numbers see **pg 74**

Over 80" Identification Bar Model S500

Features



- Fully submersible over 80" ID bar
- Rugged impact resistant design
- Available in colored or clear impact resistant lens
- TecSeal Urethane Potting - Guaranteed Circuit Board Protection
- IP68 rating while exceeding FMVSS 108 standards
- Reliable performance over 100,000 hours

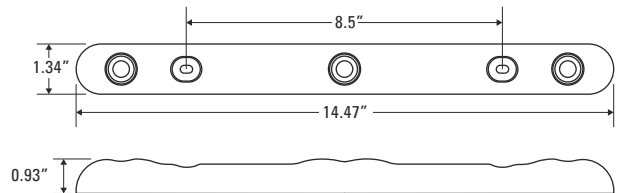

Part No.	Part Description	Amps	Color	Std Pack
S50-RRB0-1	Tri-Bar Red Red Lens Black Body	0.18A - 0.24A		25
S50-RCB0-1	Tri-Bar Red Clear Lens Black Body			25
S50-AAB0-1	Tri-Bar Amber Amber Lens Black Body			25
S50-ACB0-1	Tri-Bar Amber Clear Lens Black Body			25

Over 80" Identification Bar Model S510

Features



- Fully submersible over 80" ID bar
- New sleek design matches S180 side marker
- TecSeal Urethane Potting - Guaranteed Circuit Board Protection
- Durable impact resistant lens
- Available in colored or clear impact resistant lens
- IP68 rating while exceeding FMVSS 108 standards
- Reliable performance over 100,000 hours

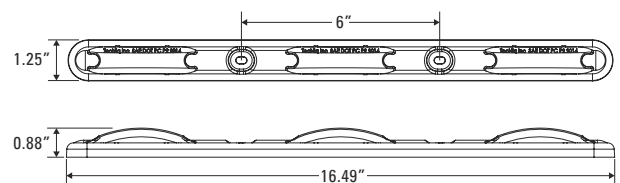

Part No.	Part Description	Amps	Color	Std Pack
S51-RR00-1	Tri-Bar Red LED, Red Lens, Black Body, Pigtail	0.16A - 0.20A		25
S51-RC00-1	Tri-Bar Red LED, Clear Lens, Black Body, Pigtail			25
S51-AA00-1	Tri-Bar Amber LED, Amber Lens, Black Body, Pigtail			25
S51-AC00-1	Tri-Bar Amber LED, Clear Lens, Black Body, Pigtail			25

V-Shaped Over 80" Identification Bar Model S520

NEW



Features



- Fully submersible LED Identification bar
- TecSeal Urethane Potting - Guaranteed Circuit Board Protection
- Durable impact resistant lens
- Available in colored or clear impact resistant lens
- IP68 rating while exceeding FMVSS 108 standards
- Reliable performance over 100,000 hours

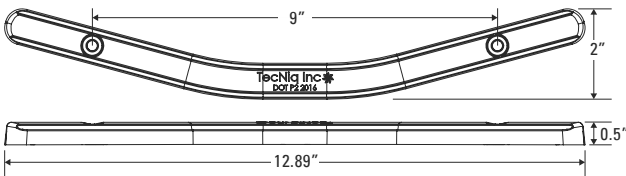

Part No.	Part Description	Amps	Color	Std Pack
S52-RR00-1	V-Shaped Over 80" Tri-Bar Red LED, Red Lens, Pigtail	0.07A - 0.09A		25
S52-RR10-1	V-Shaped Over 80" Tri-Bar Red LED, Red Lens, 58" Pigtail			25
S52-RC00-1	V-Shaped Over 80" Tri-Bar Red LED, Clear Lens, Pigtail			25
S52-RC10-1	V-Shaped Over 80" Tri-Bar Red LED, Clear Lens, 58" Pigtail			25

Over 80" Identification Bar Model T120



* Available with auxiliary white function



* Optional chrome bezel available

Features



- Meets all FMVSS 108 requirements for wide and narrow vehicles
- IP68 Rated - Dust and water proof with hermetic seal
- TecSeal Urethane Potting - Guaranteed Circuit Board Protection
- Durable impact resistant lens
- Excellent UV Resistance - Automotive exterior lighting grade polycarbonate
- Reliable performance over 100,000 hours
- Can be mounted horizontal, vertical, or at any angle

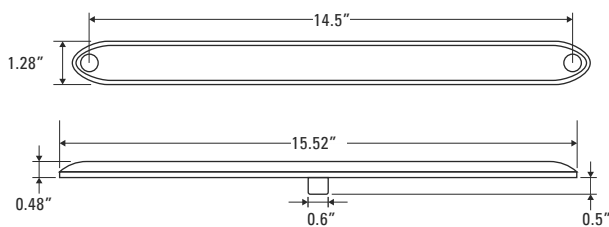

Part No.	Part Description	Amps	Color	Std Pack
T12-RR00-1	Red Low Profile ID Bar Red Lens	0.04A - 0.07A		100
T12-RC00-1	Red Low Profile ID Bar Clear Lens			100
T12-AA00-1	Amber Low Profile ID Bar Amber Lens			100
T12-AC00-1	Amber Low Profile ID Bar Clear Lens			100
T12-RW00-1	Red ID Bar/Load Lamp Clear Lens	0.07A / 0.4A(W)		100

For full list of part numbers see **pg 74**

LED Reverse Lamp Model T410

Grommet Mount

Flange Mount



* Flange Mount with SS trim



* Can also be used anywhere else you need a durable, long-lasting light source

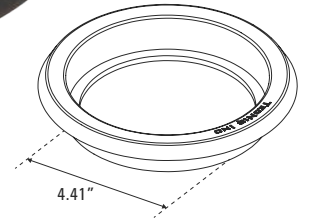

Features



- Bright and durable reverse light
- Fits all industry standard 4" applications
- Lamp is certified for both, one or two backup lamp systems
- TecSeal Urethane Potting - Guaranteed Circuit Board Protection
- Excellent UV Resistance - Automotive exterior lighting grade polycarbonate
- IP68 Rated - Dust and water proof with hermetic seal
- Reliable performance over 50,000 hours
- Mounts with standard grommets or our anti-theft stainless steel trim ring

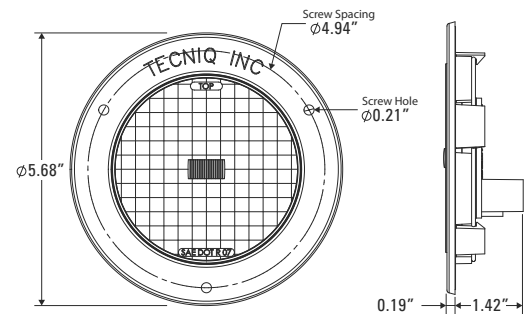
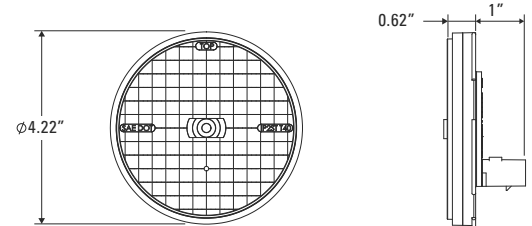

Part No.	Part Description	Amps	Color	Std Pack
T40-0G00-1	4" Round Grommet			100
T41-WC0P-1	4" Round 2x Reverse Lamp Grommet w/Pig Tail	0.26A - 0.34A	<input type="checkbox"/> <input type="checkbox"/>	100
T41-WCFP-1	4" Round 2X Reverse Lamp Clear Lens Flange Mount Pigtail		<input type="checkbox"/> <input type="checkbox"/>	100

For full list of part numbers see **pg 76**

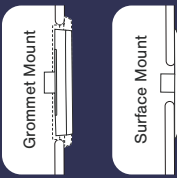

LED Reverse Lamp Model T660



*Surface mount with chrome trim

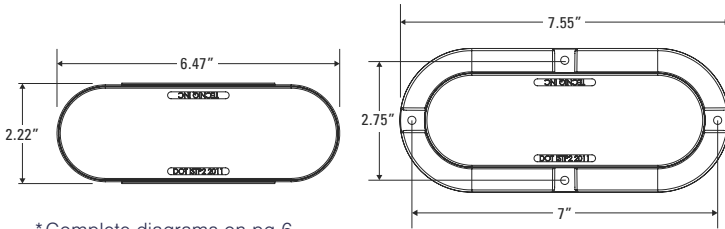

* Complete diagrams on pg 6

Features



- Smooth surface, great looking reverse light
- Durable impact resistant lens
- Fits all industry standard 6" oval applications
- Available in grommet, surface, or flange mount
- Can be mounted horizontal, vertical, or at any angle
- TecSeal Urethane Potting - Guaranteed Circuit Board Protection
- Excellent UV Resistance - Automotive exterior lighting grade polycarbonate
- IP68 Rated - Dust and water proof with hermetic seal
- Meets all FMVSS 108 requirements for wide and narrow vehicles
- Reliable performance over 100,000 hours

Part No.	Part Description	Amps	Color	Std Pack
T66-WCRP-1	6" Oval Reverse 6 LED White Grommet Mount Clear Lens Pigtail	0.21A - 0.27A	<input type="checkbox"/> <input type="radio"/>	140
T66-WCSP-1	6" Oval Reverse 6 LED White Surface Mount Clear Lens Pigtail		<input type="checkbox"/> <input type="radio"/>	140

For full list of part numbers see **pg 78**



LED Reverse Lamp Model T620

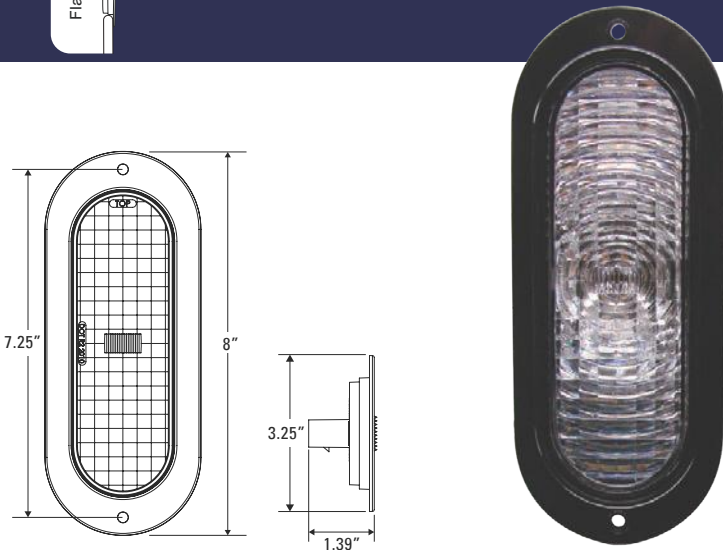

Features



- Flange mount 6" oval reverse light - fits all industry standard applications
- Can be purchased for horizontal or vertical position mounting - separate part numbers
- TecSeal Urethane Potting - Guaranteed Circuit Board Protection
- IP68 Rated - Dust and water proof with hermetic seal
- Durable impact resistant lens
- Meets all FMVSS 108 requirements for wide and narrow vehicles
- Reliable performance over 100,000 hours

Part No.	Part Description	Amps	Color	Std Pack
T62-W0VA-1	Oval Tail Reverse Lamp Flange Vertical Mount Amp Connector	0.31A - 0.39A	<input type="checkbox"/> <input type="radio"/>	120

For full list of part numbers see **pg 78**

2" Vertical Plane License Plate Light Model L100

Features



- SAE DOT rated
- IP68 Rated - Dust and water proof
- TecSeal Urethane Potting - Guaranteed Circuit Board Protection
- Durable impact resistant lens
- Life performance over 50,000 hours
- Easily mounts using just two screws
- Available in our black or chrome finish



* Also available in black

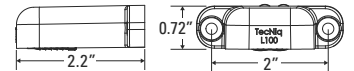

Part No.	Part Description	Amps	Color	Std Pack
L10-WB00-1	Black Base License Lamp Vertical Plane Mount	0.06A - 0.11A	<input type="checkbox"/> <input type="radio"/>	10
L10-WC00-1	Chrome Base License Lamp Vertical Plane Mount		<input type="checkbox"/> <input type="radio"/>	10

For full list of part numbers see **pg 69**

1" Vertical Plane License Plate Light Model L110

Features



- SAE DOT rated
- IP68 Rated - Dust and water proof
- TecSeal Urethane Potting - Guaranteed Circuit Board Protection
- Durable impact resistant lens
- Life performance over 50,000 hours
- Easily mounts using just two screws
- Available in our black or chrome finish



* Also available in black

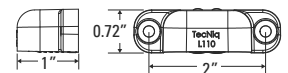

Part No.	Part Description	Amps	Color	Std Pack
L11-WB00-1	Black Base License Lamp Vertical Plane Mount	0.06A - 0.11A	<input type="checkbox"/> <input type="radio"/>	10
L11-WC00-1	Chrome Base License Lamp Vertical Plane Mount		<input type="checkbox"/> <input type="radio"/>	10

For full list of part numbers see **pg 69**

3/4" Horizontal Plane License Plate Light Model L120



* Also available in black

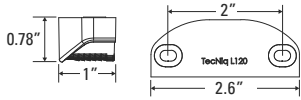

Features



- SAE DOT rated
- IP68 Rated - Dust and water proof
- TecSeal Urethane Potting - Guaranteed Circuit Board Protection
- Durable impact resistant lens
- Life performance over 50,000 hours
- Easily mounts using just two screws
- Available in our black or chrome finish

Part No.	Part Description	Amps	Color	Std Pack
L12-WB00-1	Black Base License Lamp Horizontal Plane Mount	0.06A - 0.11A	<input type="checkbox"/> <input type="checkbox"/>	10
L12-WC00-1	Chrome Base License Lamp Horizontal Plane Mount		<input type="checkbox"/> <input type="checkbox"/>	10

For full list of part numbers see **pg 69**

3/4" Grommet License Plate Light Model L340



*Steel Bracket not included

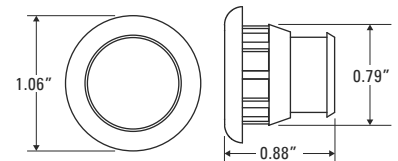

Features



- SAE DOT Rated
- IP68 Rated - Dust and water proof
- TecSeal Urethane Potting - Guaranteed Circuit Board Protection
- Durable impact resistant lens
- Easily mounts into standard 3/4" hole also available with large grommet style (1.19" mounting hole)
- Life performance over 50,000 hours

Part No.	Part Description	Amps	Color	Std Pack
L34-WC9B-1	3/4" Bullet style License Lamp, Large Grommet w/ .180 bullets	0.07A - 0.09A	<input type="checkbox"/> <input type="checkbox"/>	10
L34-WG9B-1	3/4" Bullet Style License Lamp, Standard Grommet w/ .180 bullets		<input type="checkbox"/> <input type="checkbox"/>	10

For full list of part numbers see **pg 69**

Low Profile Sidemarker Model S170

PC/P2
RATED



*Optional chrome mounting bezel

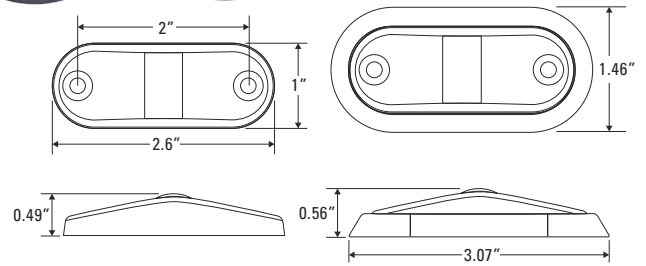
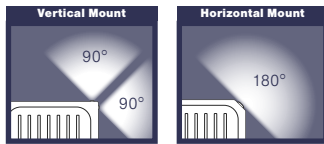

Features

- Surface mounted PC/P2 rated marker light
- Optional chrome bezel, offers premium appearance
- Custom fit TPE gaskets also available
- Automotive exterior lighting grade polycarbonate
- TecSeal Urethane Potting - Guaranteed Circuit Board Protection
- IP68 Rated - Dust and water proof
- Exceeds FMVSS 108 standards
- Reliable performance over 100,000 hours

Part No.	Part Description	Amps	Color	Std Pack
S17-RR0P-1	Model S170 Red P2/PC Sidemarker Red Lens 6" Pigtail	0.07A - 0.09A		100
S17-RC0P-1	Model S170 Red P2/PC Sidemarker Clear Lens 6" Pigtail	0.04A - 0.07A		100
S17-AA0P-1	Model S170 Amber P2/PC Sidemarker Amber Lens 6" Pigtail	0.07A - 0.09A		100
S17-AC0P-1	Model S170 Amber P2/PC Sidemarker Clear Lens 6" Pigtail	0.04A - 0.07A		100

For full list of part numbers see **pg 70**

Low Profile Sidemarker Model S140

PC/P2
RATED

NEW



*Stud mounted

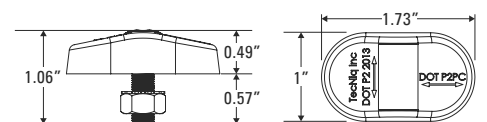
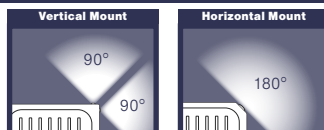

Features

- Brilliant illumination in a compact size
- IP68 Rated - Dust and water proof
- TecSeal Urethane Potting - Guaranteed Circuit Board Protection
- Stud-mounted, no visible fasteners
- Exceeds FMVSS 108 standards
- Reliable performance over 100,000 hours
- Vertical mount position meets P2 specifications, while horizontal mount meets PC specifications.

Part No.	Part Description	Amps	Color	Std Pack
S14-RRS0-1	S14 Red PCP2 Stud Mount Marker Light Red Lens Pigtail	0.04A - 0.07A		100
S14-RCS0-1	S14 Red PCP2 Stud Mount Marker Light Clear Lens Pigtail			100
S14-AAS0-1	S14 Amber PCP2 Stud Mount Marker Light Amber Lens Pigtail			100
S14-ACS0-1	S14 Amber PCP2 Stud Mount Marker Light Clear Lens Pigtail			100

For full list of part numbers see **pg 70**

Surface Mounted Sidemarker Model S180



*White area light version available

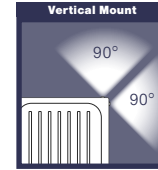

Features



- Great combination of sleek, smooth design that is extremely tough
- Vertical mount position meets P2 specifications, while horizontal mount meets PC specifications.
- Excellent UV Resistance - Automotive exterior lighting grade polycarbonate
- TecSeal Urethane Potting - Guaranteed Circuit Board Protection
- IP68 Rated - Dust and water proof
- Durable impact resistant lens
- Exceeds FMVSS 108 standards
- Reliable life performance over 100,000 hours

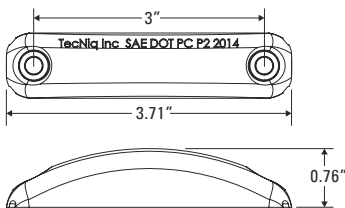

Part No.	Part Description	Amps	Color	Std Pack
S18-RR00-1	3.5"x.75" Surface mount P2/PC rated Red sidemarker Hardwired	0.06A - 0.08A	■ ●	10
S18-RRG0-1	3.5"x.75" Surface mount P2/PC rated Red sidemarker Self Ground		■ ●	10
S18-RC00-1	3.5"x.75" Surface mount P2/PC rated Red/Clear sidemarker Hardwired	0.05A - 0.07A	■ 	10
S18-RCG0-1	3.5"x.75" Surface mount P2/PC rated Red/Clear sidemarker Self Ground		■ 	10
S18-AA00-1	3.5"x.75" Surface mount P2/PC rated Amber sidemarker Hardwired	0.06A - 0.08A	■ ●	10
S18-AAG0-1	3.5"x.75" Surface mount P2/PC rated Amber Sidemarker Self Ground		■ ●	10
S18-AC00-1	3.5"x.75" Surface mount P2/ PC rated Amber/Clr sidemarker Hardwired	0.05A - 0.07A	■ 	10
S18-ACG0-1	3.5"x.75" Surface mount P2/PC rated Amber/Clr sidemarker Self Ground		■ 	10
S18-WC00-1	3.5"x.75" Surface Mount Area Light hardwired	0.10A - 0.15A	 	10

3/4" Grommet Mounted Sidemarker Model S330

**P2
RATED**









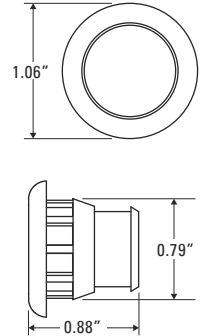

*Optional 316 stainless steel trim ring

Features



- Easily mounts into standard 3/4" hole
- TecSeal Urethane Potting - Guaranteed Circuit Board Protection
- Excellent UV Resistance - Automotive exterior lighting grade polycarbonate
- IP68 Rated - Dust and water proof
- Light output exceeds FMVSS 108 specifications
- 316 stainless steel trim ring available
- Reliable performance over 100,000 hours



Part No.	Part Description	Amps	Color	Std Pack
S33-RR09-1	3/4" Mini P2 Red Sidemarker Red Lens white ground wire	0.05A - 0.07A	 	100
S33-RC09-1	3/4" Mini P2 Red Sidemarker Clear Lens white ground wire		 	100
S33-AA09-1	3/4" Mini P2 Amber Sidemarker Amber Lens, white ground wire		 	100
S33-AC09-1	3/4" Mini P2 Amber Sidemarker Clear Lens, white ground wire		 	100

For full list of part numbers see **pg 72**

3/4" Grommet Mounted Sidemarker Model S340

**PC/P2
RATED**



*Optional 316 stainless steel trim ring

Features









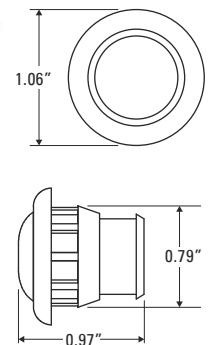





- Easily mounts into standard 3/4" hole, no alignment required
- Excellent UV Resistance - Automotive exterior lighting grade polycarbonate
- TecSeal Urethane Potting - Guaranteed Circuit Board Protection
- IP68 Rated - Dust and water proof
- Durable impact resistant lens
- PC/P2 output exceeds FMVSS 108 specifications
- Reliable performance over 100,000 hours



*Three light model for ID bar



Part No.	Part Description	Amps	Color	Std Pack
S34-RR09-1	Red Mini PC Sidemarker Red Lens white ground wire	0.07A - 0.09A	 	100
S34-RC09-1	Red Mini PC Sidemarker Clear Lens white ground wire	0.06A - 0.08A	 	100
S34-RR30-1	Red Mini 3 Light PC Over 80 ID assembly 12" Lead	0.20A - 0.28A	 	100
S34-RR31-1	Red Mini 3 Light PC Over 80 ID assembly 48" Lead		 	100
S34-AA09-1	Amber Mini PC Sidemarker Amber Lens white ground wire	0.07A - 0.09A	 	100
S34-AC09-1	Amber Mini PC Sidemarker Clear Lens white ground wire	0.03A - 0.06A	 	100

For full list of part numbers see **pg 72**

PC/P2
RATED

NEW

3/4" Mini Grommet Mounted Sidemarker Model S370









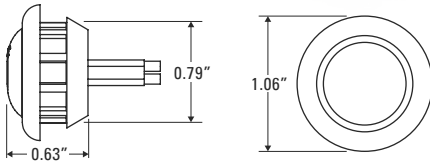

*Optional 316 stainless steel trim ring



Features

- New mini 3/4" grommet mount clearance markers, half the depth allowing for installation in very tight spaces.
- TecSeal Urethane Potting - Guaranteed Circuit Board Protection
- IP68 Rated - Dust and water proof
- 316 stainless steel trim ring available
- PC/P2 output exceeds FMVSS 108 specifications
- Reliable performance over 100,000 hours
- Also available in accent lighting colors (see index)



Part No.	Part Description	Amps	Color	Std Pack
S37-RR09-1	Red Mini Grommet Mount PC Sidemarker Red Lens	0.07A - 0.09A	 	100
S37-RC09-1	Red Mini Grommet Mount PC Sidemarker Clear Lens	0.06A - 0.08A	 	100
S37-AA09-1	Amber Mini Grommet Mount PC Sidemarker Amber Lens	0.07A - 0.09A	 	100
S37-AC09-1	Amber Mini Grommet Mount PC Sidemarker Clear Lens	0.03A - 0.06A	 	100

For full list of part numbers see **pg 73**

PC/P2
RATED

NEW







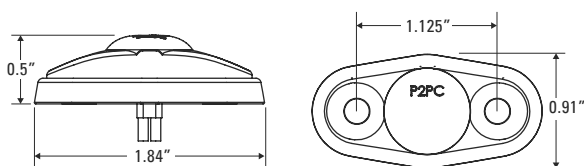

Surface Mounted Sidemarker Model S380



Features

- New surface mounted mini clearance markers, offer a great appearance, easy installation, and can be purchased with available gasket.
- Easily mounts with two screws
- TecSeal Urethane Potting - Guaranteed Circuit Board Protection
- IP68 Rated - Dust and water proof
- PC/P2 output exceeds FMVSS 108 specifications
- Reliable performance over 100,000 hours
- Also available in accent lighting colors (see index)



Part No.	Part Description	Amps	Color	Std Pack
S38-RR09-1	Red Mini Surface Mount PC Sidemarker Red Lens	0.07A - 0.09A	 	100
S38-RC09-1	Red Mini Surface Mount PC Sidemarker Clear Lens	0.06A - 0.08A	 	100
S38-AA09-1	Amber Mini Surface Mount PC Sidemarker Amber Lens	0.07A - 0.09A	 	100
S38-AC09-1	Amber Mini Surface Mount PC Sidemarker Clear Lens	0.03A - 0.06A	 	100

For full list of part numbers see **pg 74**

2" Surface Mounted Sidemarker Model S210

**P2
RATED**

Features



- Another great combination of appealing appearance and extreme durability
- Optional 316 stainless steel cover, hides the fasteners
- Excellent UV Resistance - Automotive exterior lighting grade polycarbonate
- TecSeal Urethane Potting - Guaranteed Circuit Board Protection
- IP68 Rated - Dust and water proof
- Durable impact resistant lens
- Exceeds FMVSS 108 standards
- Reliable performance over 100,000 hours



* Optional stainless steel trim ring

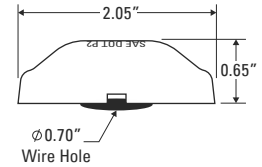
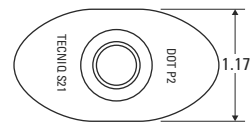

Part No.	Part Description	Amps	Color	Std Pack
S21-RR00-1	2" Oval Red Sidemarker Red Lens Pigtail Connection	0.04A - 0.07A		100
S21-RC00-1	2" Oval Red Sidemarker Clear Lens Pigtail Connection			100
S21-AA00-1	2" Oval Amber Sidemarker Amber Lens Pigtail Connection			100
S21-AC00-1	2" Oval Amber Sidemarker Clear Lens Pigtail Connection			100

For full list of part numbers see **pg 71**

4"x 0.75" Surface Mount Sidemarker Model S360

**PC/P2
RATED**

Features



- Easy installation surface mount design
- P2/PC Rated side marker
- Excellent UV Resistance - Automotive exterior lighting grade polycarbonate
- TecSeal Urethane Potting - Guaranteed Circuit Board Protection
- Uses S99 two pole spade connector (see page 52)
- IP68 Rated - Dust and water proof
- Durable impact resistant lens
- Exceeds FMVSS 108 standards
- Reliable performance over 100,000 hours

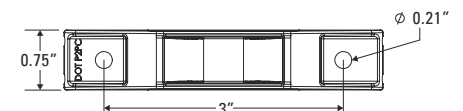
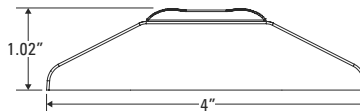

Part No.	Part Description	Amps	Color	Std Pack
S36-RR20-1	S36 Red PC Sidemarker Red Lens	0.05A - 0.07A		100
S36-RC20-1	S36 Red PC Sidemarker Clear Lens			100
S36-AA20-1	S36 Amber PC Sidemarker Amber Lens			100
S36-AC20-1	S36 Amber PC Sidemarker Clear Lens			100

For full list of part numbers see **pg 73**

**P2
RATED**

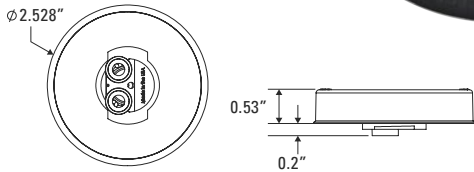

2.5" Round Sidemarker w/ Reflector Model S100



Features



- TecSeal Urethane Potting - Guaranteed Circuit Board Protection
- Excellent UV Resistance - Automotive exterior lighting grade polycarbonate
- IP68 Rated - Dust and water proof with hermetic seal
- Durable impact resistant lens
- Exceeds FMVSS 108 standards
- Reliable performance over 100,000 hours
- Standard non-polarized connector
- Energy efficient: Draws only 0.06A at 12VDC

Part No.	Part Description	Amps	Color	Std Pack
S10-0G00-1	2.5" Round Sidemarker Grommet			150
S10-RR00-1	2.5" Round Red P2 Sidemarker with Reflectivity	0.06A - 0.08A		150
S10-AA00-1	2.5" Round Amber P2 Sidemarker with Reflectivity			150

For full list of part numbers see **pg 70**

**P2
RATED**



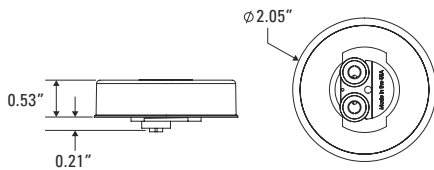

2" Round Sidemarker Model S300



Features



- Grommet mounted industry standard size
- TecSeal Urethane Potting - Guaranteed Circuit Board Protection
- Excellent UV Resistance - Automotive exterior lighting grade polycarbonate
- IP68 Rated - Dust and water proof with hermetic seal
- Durable impact resistant lens
- Exceeds FMVSS 108 standards
- Standard non-polarized connector
- Reliable performance over 100,000 hours

Part No.	Part Description	Amps	Color	Std Pack
S30-0G00-1	2" Round Sidemarker Grommet			125
S30-RR00-1	2" Round Red Sidemarker Red Lens	0.06A - 0.08A		125
S30-RC00-1	2" Round Red Sidemarker Clear Lens			125
S30-AA00-1	2" Round Amber Sidemarker Amber Lens	0.06A - 0.08A		125
S30-AC00-1	2" Round Amber Sidemarker Clear Lens			125

For full list of part numbers see **pg 72**

1"x 2" Surface Mounted Sidemarker Model S150

PC/P2
RATED

Features



- Excellent UV Resistance - Automotive exterior lighting grade polycarbonate
- TecSeal Urethane Potting - Guaranteed Circuit Board Protection
- IP68 Rated - Dust and water proof
- Durable impact resistant lens
- Exceeds FMVSS 108 standards
- Reliable performance over 100,000 hours
- Standard non-polarized connector

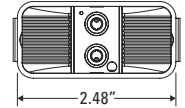
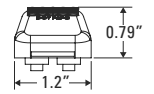

* Requires mounting bases available in chrome or black

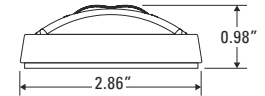
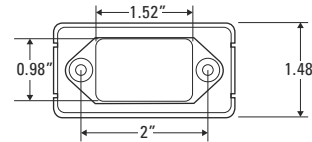

Part No.	Part Description	Amps	Color	Std Pack
S15-0B00-1	Model S150 Base Black			100
S15-0S00-1	Model S150 Base Chrome			100
S15-0G00-1	Model S150 Grommet			100
S15-RR00-1	Model S150 Red PC Sidemarker Red Lens	0.04A - 0.07A		120
S15-RC00-1	Model S150 Red PC Sidemarker Clear Lens			120
S15-RC0P-1	Model S150 Red PC Sidemarker Clear Lens 6' Pigtail			200
S15-AA00-1	Model S150 Amber PC Sidemarker Amber Lens			120
S15-AC00-1	Model S150 Amber PC Sidemarker Clear Lens			120
S15-AC0P-1	Model S150 Amber PC Sidemarker Clear Lens 6' Pigtail			200

For full list of part numbers see **pg 70**

1"x 4" Surface Mounted Sidemarker Model S190

PC/P2
RATED

Features



- Standard non-polarized male connector
- Excellent UV Resistance - Automotive exterior lighting grade polycarbonate
- TecSeal Urethane Potting - Guaranteed Circuit Board Protection
- IP68 Rated - Dust and water proof
- Durable impact resistant lens
- Exceeds FMVSS 108 standards
- Reliable life performance over 100,000 hours

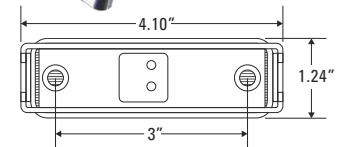
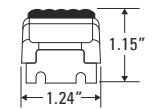

* Requires mounting bases available in chrome or black

Part No.	Part Description	Amps	Color	Std Pack
S19-0B00-1	Black 1" x4" Self Grounding Base			120
S19-0C00-1	Chrome 1" x4" Self Grounding Base			120
S19-RR00-1	1"x4" Red PC Sidemarker Red Lens	0.04A - 0.07A		120
S19-RC00-1	1"x4" Red PC Sidemarker Clear Lens			120
S19-AA00-1	1"x4" Amber PC Sidemarker Amber Lens			120
S19-AC00-1	1"x4" Amber PC Sidemarker Clear Lens			120

For full list of part numbers see **pg 71**

PC/P2
RATED

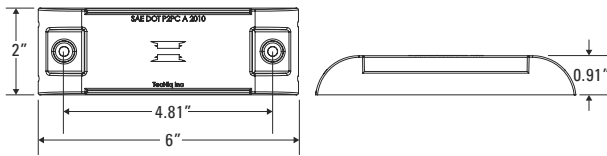

2"x 6" Sidemarker w/ Reflector Model S220



Features



- Integrated retro-reflector, eliminating the need for additional reflectors
- TecSeal Urethane Potting - Guaranteed Circuit Board Protection
- Excellent UV Resistance - Automotive exterior lighting grade polycarbonate
- Uses S99 two pole spade connector (see page 52)
- IP68 Rated - Dust and water proof
- Durable impact resistant lens
- Exceeds FMVSS 108 requirements
- Reliable performance over 100,000 hours

Part No.	Part Description	Amps	Color	Std Pack
S22-RR00-1	Red 2" x 6" PC Sidemarker with reflector	0.04A - 0.07A		100
S22-AA00-1	Amber 2" x 6" PC Sidemarker with reflector			100

For full list of part numbers see **pg 71**

Reflective Conspicuity Tape

NEW



*SAE reflector sticker patterns

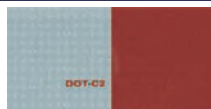

*SAE red/white reflector roll



Features



- Reflexite® Conspicuity Tape by Orafol is now available from TecNiq Inc.
- V82 OEM Grade Microprismatic Conspicuity Tape in 11" Red/ 7" White – 2"x 150' Rolls.
- Amber & Red 3" Round SAE/DOT Reflectors
- Amber & Red 2" x 3.5" Rectangle SAE/DOT Reflectors.
- These products are well known for their high performance polyester film and weather resistance.
- All exceed the FMVSS 108, DOT standards, and will maintain their performance after an impact.
- Please contact your TecNiq Inc. salesperson for ordering information.

Part No.	Part Description	Std Pack
R03-0A00-1	Amber 3" Round SAE Reflector - Roll of 100	1
R03-0R00-1	Red 3" Round SAE Reflector - Roll of 100	1
R05-0A00-1	Amber 2" x 3.5" Rectangular SAE Reflector - Roll of 500	1
R05-0R00-1	Red 2" x 3.5" Rectangular SAE Reflector - Roll of 500	1
R10-0RW0-1	Red 11"x White 7" OEM Grade SAE DOT Stripe Reflector - 150' Roll	1

Rugged Dual LED Fender Light Model S900



*Optional stainless steel trim ring



*S90-OB20-1 (wall cover)



Features



- Completely submersible bi-color red/amber LED fender light
- Low profile design
- TecSeal Urethane Potting - Guaranteed Circuit Board Protection
- Excellent UV Resistance - Automotive exterior lighting grade polycarbonate
- IP68 Rated - Dust and water proof
- Durable impact resistant lens
- Reliable performance over 100,000 hours

* Available with two or four mounting holes

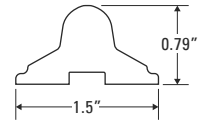
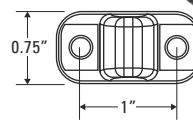

Part No.	Part Description	Amps	Color	Std Pack
S90-0000-1	Fender Sidemarker Light	0.04A - 0.07A		150
S90-0BS0-1	Fender Sidemarker Light Wire Guide 4 Hole Black			150
S90-0CS0-1	Fender Sidemarker Light Wire Guide 4 Hole Chrome			150
S90-0SS0-1	Fender Sidemarker Light SS Stamping			150

For full list of part numbers see **pg 74**

4" Surface Mounted Fender Light Model S910

Features



- New fender light with excellent durability
- Fully submersible bi-color red/amber LED fender light
- Part of the S180 side marker family
- TecSeal Urethane Potting - Guaranteed Circuit Board Protection
- Excellent UV Resistance - Automotive exterior lighting grade polycarbonate
- IP68 Rated - Dust and water proof
- Reliable performance over 100,000 hours
- Low amp draw
- Easily mounts with just two screws

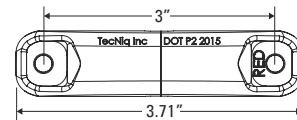

Part No.	Part Description	Amps	Color	Std Pack
S91-AR00-1	Fender Sidemarker Light, Red/Amber Lens Pigtail	0.06A - 0.07A		100
S91-ARC0-1	Fender Sidemarker Light, Clear Lens, Red/Amber LED Pigtail			100

High Output Link Lights Model D210

NEW









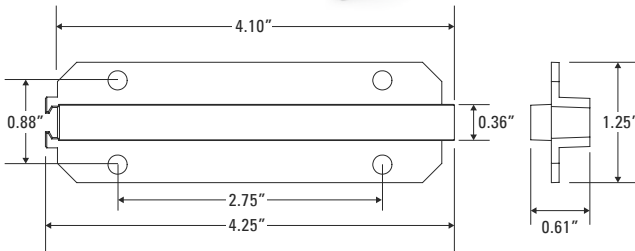



Features



- Innovative Link feature – allowing lights to be easily connected and installed together
- Five bright colors – Amber, Blue, Green, Red, and White
- Guaranteed to be water & shock proof
- Perfect for rub rails, accent lighting, area or deck lighting, high moisture exposure locations
- Can be installed with adhesive tape or mechanical fastener



Part No.	Part Description	Amps	Color	Std Pack
D21-AC00-1	Emergency Accessory Light, Amber LED	0.155A - 0.215A	 	50
D21-BC00-1	Emergency Accessory Light, Blue LED	0.145A - 0.205A	 	50
D21-GC00-1	Emergency Accessory Light, Green LED	0.145A - 0.205A	 	50
D21-RC00-1	Emergency Accessory Light, Red LED	0.155A - 0.215A	 	50
D21-WC00-1	Emergency Accessory Light, White LED	0.145A - 0.205A	 	50

For full list of part numbers see **pg 59**

Nylon Nut Mounted Accent Light Model M900



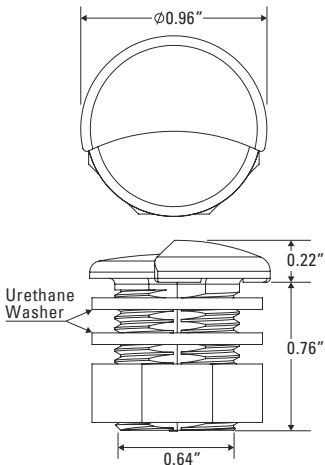





NEW



Features



- Completely waterproof light, perfect for illuminating steps or walk ways
- Easy installation with threaded nylon nut
- Includes two chemical resistant TPE gaskets
- Comes with our corrosion resistant 316 SS polished cover
- IP68 Rated – water & dust proof
- Life performance: 50,000 hours

Part No.	Part Description	Amps	Color	Std Pack
M90-BS00-1	Interior Accent Light, Blue LED, SS Cover	0.03A - 0.04A	 	50
M90-GS00-1	Interior Accent Light, Green LED, SS Cover	0.03A - 0.04A	 	50
M90-RS00-1	Interior Accent Light, Red LED, SS Cover	0.06A - 0.08A	 	50
M90-WS00-1	Interior Accent Light, White LED, SS Cover	0.07A - 0.09A	 	50

For full list of part numbers see **pg 69**

Mini Accent Light Model S330



Features

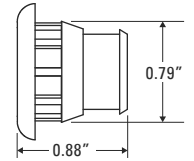
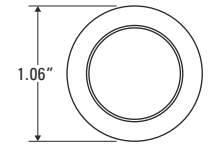

*Stainless steel trim ring optional

- Easily mounts into standard 3/4" hole
- TecSeal Urethane Potting - Guaranteed Circuit Board Protection
- IP68 Rated - Dust and water proof
- Durable impact resistant lens
- 316 stainless steel trim ring available
- Reliable performance over 100,000 hours (color)
50,000 hours (white)

Part No.	Part Description	Amps	Color	Std Pack
S33-AC00-1	3/4" Mini P2 Amber Sidemarker Clear Lens	0.05A - 0.07A		100
S33-BC00-1	3/4" Round Low Profile Blue Indicator	0.02A - 0.03A		100
S33-GC00-1	3/4" Round Low Profile Green Indicator			100
S33-RC00-1	3/4" Mini P2 Red Sidemarker Clear Lens			100
S33-WC00-1	3/4" Round Low Profile White Indicator	0.06A - 0.08A		100

For full list of part numbers see **pg 72**

LED Pod Lighting Model D020

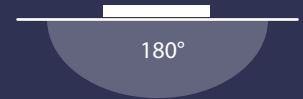

Features



- Provides an impressive 50 lumens per pod (white)
- Sealed light is vibration and water proof
- Up to 100 lamps per string, spaced 14 inches
- Easily installed with **3M** adhesive tape back
- Life performance: 50,000 hours
- Contact your salesperson for ordering information

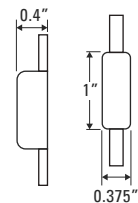

Part No.	Part Description	Amps	Color	Std Pack
D02-A001-1	Ladder Light Amber 1 Section - 14" Section Length	0.06A - 0.08A		Made to Order
D02-B001-1	Ladder Light Blue 1 Sections - 14" Section Length	0.03A - 0.04A		Made to Order
D02-G001-1	Ladder Light Green 1 Section - 14" Section Length			Made to Order
D02-R001-1	Ladder Light Red 1 Section - 14" Section Length			Made to Order
D02-W001-1	Ladder Light White 1 Section - 14" Section Length	0.07A - 0.09A		Made to Order

For full list of part numbers see **pg 58**

LED Strip Lighting Model E410





*Interior and covered applications only

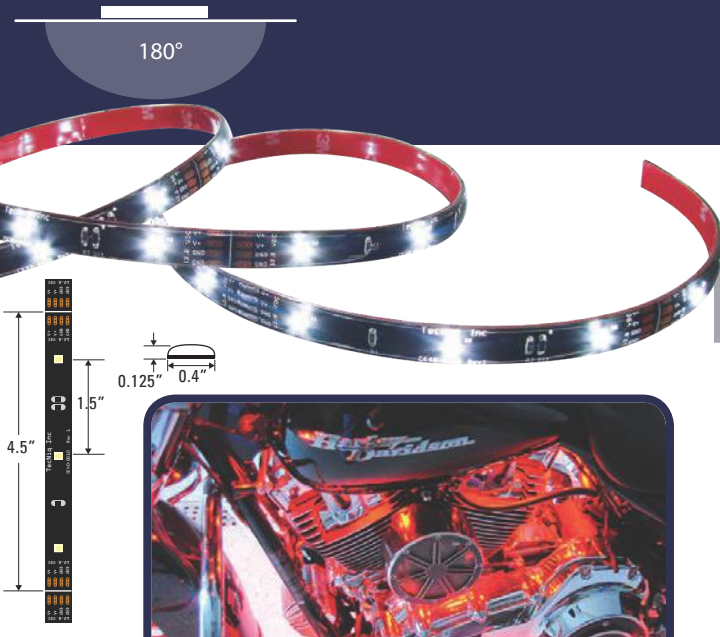

Features

- Produces 100 lumens per 4.5" section (white)
- Available in 4.5" increments up to 16.5'
- Ultra thin 3/16" strips surface mounts easily in tight spaces
- High flexibility conforms to irregular surfaces
- Easily installed with **3M** adhesive tape back
- Life performance: 50,000 hours
- Contact your salesperson for ordering information



Part No.	Part Description	Amps	Color	Std Pack
E41-000V-1	2 wire termination			
E41-304X-1	Flexible LED Light RGB 18" - Dual 4 -Wire Pigtail	Varies	 <input type="radio"/>	-
E41-A010-1	Flexible LED Light Amber 4.5" - No Wire	0.58A-0.70A/6ft	 <input type="radio"/>	Made to Order
E41-B010-1	Flexible LED Light Blue 4.5" - No Wire	0.41A-0.50A/6ft	 <input type="radio"/>	Made to Order
E41-G010-1	Flexible LED Light Green 4.5" - No Wire	0.41A-0.50A/6ft	 <input type="radio"/>	Made to Order
E41-R010-1	Flexible LED Light Red 4.5" - No Wire	0.58A-0.70A/6ft	 <input type="radio"/>	Made to Order
E41-W010-1	Flexible LED Light White 4.5" - No Wire	0.75A-0.91A/6ft	<input type="checkbox"/> <input type="radio"/>	Made to Order

E41 Available in custom lengths from 4.5" – 16.5 ft (4.5" increments)





LED Strip Lighting Model E440

NEW

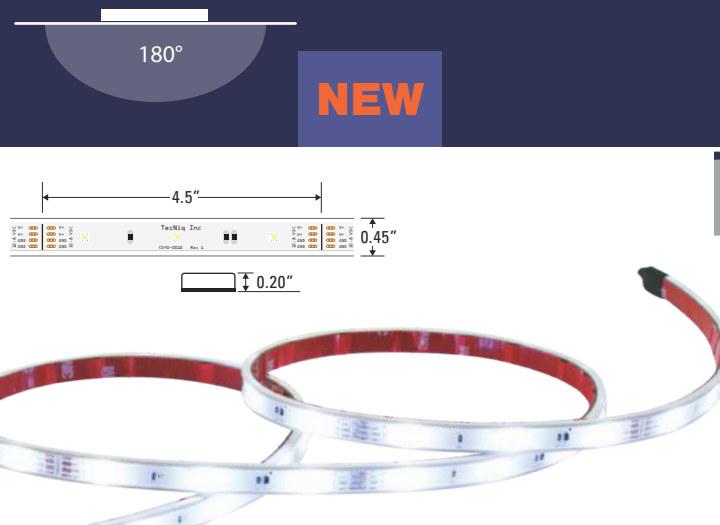
Features

- Produces 100 lumens per 4.5" section (white)
- Available in 4.5" increments up to 16.5'
- Ultra thin 3/16" strips surface mounts easily in tight spaces
- High flexibility conforms to irregular surfaces
- Easily installed with **3M** adhesive tape back
- Life performance: 50,000 hours
- Contact your salesperson for ordering information



Part No.	Part Description	Amps	Color	Std Pack
E44-000V-1	2 wire termination			
E44-304X-1	Flexible LED Light RGB 18" - Dual 4 -Wire Pigtail	Varies	 <input type="radio"/>	-
E44-A010-1	Flexible LED Light Amber 4.5" - No Wire	0.58A-0.70A/6ft	 <input type="radio"/>	Made to Order
E44-B010-1	Flexible LED Light Blue 4.5" - No Wire	0.41A-0.50A/6ft	 <input type="radio"/>	Made to Order
E44-G010-1	Flexible LED Light Green 4.5" - No Wire	0.41A-0.50A/6ft	 <input type="radio"/>	Made to Order
E44-R010-1	Flexible LED Light Red 4.5" - No Wire	0.58A-0.70A/6ft	 <input type="radio"/>	Made to Order
E44-W010-1	Flexible LED Light White 4.5" - No Wire	0.75A-0.91A/6ft	<input type="checkbox"/> <input type="radio"/>	Made to Order

E44 Available in custom lengths from 4.5" – 16.5 ft (4.5" increments)

Eon Lights Model E030



* Vertical Mount



* Horizontal Mount
(Across Surface)

Features



- Completely sealed IP68 rated design
- Easy installation – two #6 screws
- 316 stainless steel cover – horizontal and vertical orientation
- Covers required to install as surface mount – available in black and white powder coat
- Life performance: 50,000 hours
- Produces 150 lumens (white)

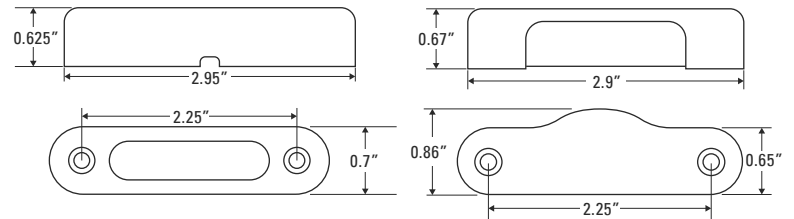

Part No.	Part Description	Amps	Color	Std Pack
E03-0SH0-1	Eon Light Linear Horizontal Case - SS			50
E03-0SV0-1	Eon Light Linear Vertical Case - SS			50
E03-A001-1	Eon Light Linear Body Amber - 36" Wire	0.11A - 0.15A		50
E03-B001-1	Eon Light Linear Body Blue - 36" Wire	0.09A - 0.13A		50
E03-D001-1	Eon Light Linear Body Deep Red - 36" Wire	0.08A - 0.12A		50
E03-G001-1	Eon Light Linear Body Green - 36" Wire	0.09A - 0.13A		50
E03-J001-1	Eon Light Linear Body Jade - 36" Wire	0.11A - 0.15A		50
E03-L000-1	Eon Light Linear Body Neutral White - 9" Wire			50
E03-M000-1	Eon Light Linear Body Warm White - 9" Wire	0.08A - 0.12A		50
E03-N001-1	Eon Light Linear Body Orange - 36" Wire			50
E03-W000-1	Eon Light Linear Body Cool White - 9" Wire			50

For full list of part numbers see **pg 59**



Dragon Lights Model D040/D140



* Vertical Mount



* Horizontal Mount



Features



- Completely sealed IP68 rated design
- Easy installation – two #4 screws
- 316 stainless steel cover
- Linear version requires cover, oval can be mounted by lens
- Cover also available in black and white powder coat
- Life performance: 50,000 hours

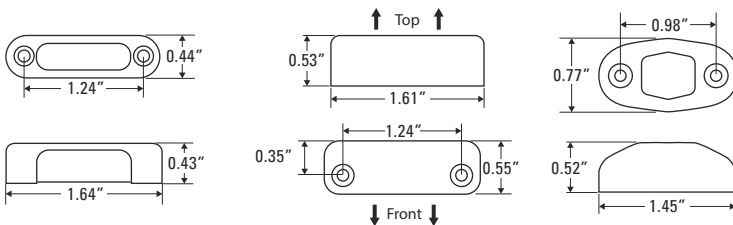

Part No.	Part Description	Amps	Color	Std Pack
D04-0SH0-1	Dragon Light Linear Horizontal Case - SS			50
D04-0SV0-1	Dragon Light Linear Vertical Case - SS			50
D04-A000-1	Dragon Light Linear Body Amber - 9" Wire			50
D04-D000-1	Dragon Light Linear Body Deep Red - 9" Wire	0.08A - 0.12A		50
D04-R000-1	Dragon Light Linear Body Red - 9" Wire			50
D04-B000-1	Dragon Light Linear Body Blue - 9" Wire	0.04A - 0.07A		50
D04-G000-1	Dragon Light Linear Body Green - 9" Wire			50
D04-W000-1	Dragon Light Linear Body White - 9" Wire	0.08A - 0.12A		50
D14-0S00-1	Dragon Light Oval Case - SS			50
D14-A000-1	Dragon Light Oval Body Amber - 9" Wire			50
D14-B000-1	Dragon Light Oval Body Blue - 9" Wire			50
D14-D000-1	Dragon Light Oval Body Deep Red - 9" Wire	0.04A - 0.07A		50
D14-G000-1	Dragon Light Oval Body Green - 9" Wire			50
D14-R000-1	Dragon Light Oval Body Red - 9" Wire			50
D14-U000-1	Dragon Light Oval Body Ultraviolet - 9" Wire	0.03A - 0.05A		50
D14-W000-1	Dragon Light Oval Body White - 9" Wire	0.04A - 0.07A		50

For full list of part numbers see **pg 58**

SteelHead Heavy Duty Work Lights Model P020/P040/P060

NEW



Features



- Designed for the most demanding task illumination applications, in the most extreme environments
- Vibration resistant and 100% water proof
- Models include Flood or Spot light projection
- Available in Black or White Heavy Duty Powder Coating
- Proprietary thermal management provides powerful performance in a small package
- Operating voltage range of 10 – 30 VDC
- IP68 Rated
- Reliable performance over 50,000 hours
- Stainless Steel mounting hardware included

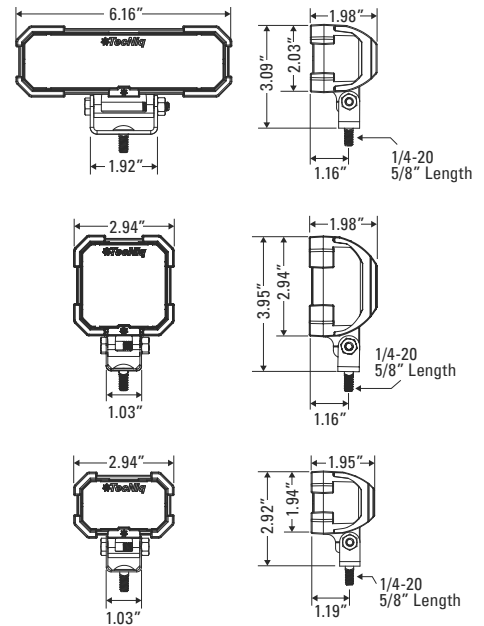

Part No.	Part Description	Lumens	Amps	Color	Std Pack	
P02-WBSP-1	SteelHead Spot Lamp 2 LED Black Finish Pigtail wires	750 Lumens	0.39A - 0.47A	Black Finish	4	
P02-WBFP-1	SteelHead Flood Lamp 2 LED Black Finish Pigtail wires				4	
P04-WBSP-1	SteelHead Spot Lamp 4 LED Black Finish Pigtail wires	1100 Lumens	0.50A - 0.62A		2	
P04-WBFP-1	SteelHead Flood Lamp 4 LED Black Finish Pigtail wires				2	
P06-WBSP-1	SteelHead Spot Lamp 6 LED Black Finish Pigtail wires	1900 Lumens	1.15A - 1.41A		2	
P06-WBFP-1	SteelHead Flood Lamp 6 LED Black Finish Pigtail wires				2	
P02-WWSP-1	SteelHead Spot Lamp 2 LED White Finish Pigtail wires	750 Lumens	0.39A - 0.47A		White Finish	4
P02-WWFP-1	SteelHead Flood Lamp 2 LED White Finish Pigtail wires					4
P04-WWSP-1	SteelHead Spot Lamp 4 LED White Finish Pigtail wires	1100 Lumens	0.50A - 0.62A			2
P04-WWFP-1	SteelHead Flood Lamp 4 LED White Finish Pigtail wires					2
P06-WWSP-1	SteelHead Spot Lamp 6 LED White Finish Pigtail wires	1900 Lumens	1.15A - 1.41A	2		
P06-WWFP-1	SteelHead Flood Lamp 6 LED White Finish Pigtail wires			2		

Custom connectors available upon request - For full list of part numbers see **pg 69**

Flush Mounted Spreader Light Model P100

NEW

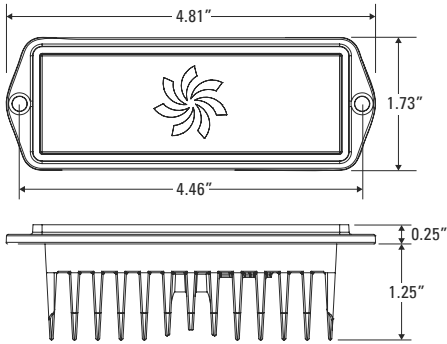

Features



- Designed for the most demanding task illumination applications, in the most extreme environments
- Vibration resistant and 100% water proof
- Built with anodized and white powder coated aluminum bodies with impact-resistant polycarbonate flood projection lenses for exceptional durability
- Available with four high-performance white LEDs, or two white and two night-vision friendly red.
- Proprietary thermal management provides powerful performance in a small package
- Operating voltage range of 9 – 30 VDC
- Completely waterproof and sealed to IP68 standards.

Part No.	Part Description	Lumens	Amps	Color	Std Pack
P10-WWFP-1	Spreader Light, White LED, White Finish, Pigtail Wires	1300 Lumens	1.08A - 1.32A	<input type="checkbox"/> <input type="radio"/>	2
P10-WRFP-1	Spreader Light, White & Red LED, White Finish, Pigtail Wires	700 Lumens	0.6A +0.15A red	<input type="checkbox"/> <input type="radio"/>	2

Custom connectors available upon request

Surface Mounted Spreader Light Model P110

NEW

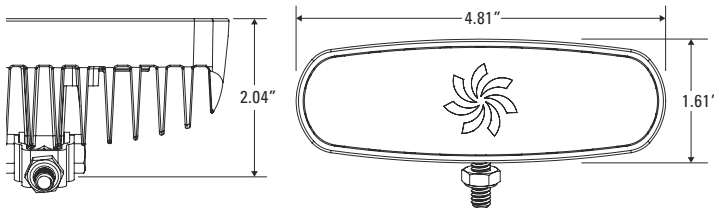

Features



- Designed for the most demanding task illumination applications, in the most extreme environments
- Vibration resistant and 100% water proof
- Built with anodized and white powder coated aluminum bodies with impact-resistant polycarbonate flood projection lenses for exceptional durability
- Available with four high-performance white LEDs, or two white and two night-vision friendly red.
- Proprietary thermal management provides powerful performance in a small package
- Operating voltage range of 9 – 30 VDC
- Completely waterproof and sealed to IP68 standards.
- Stainless Steel mounting hardware included

Part No.	Part Description	Lumens	Amps	Color	Std Pack
P11-WWFP-1	Spreader Light, White LED, White Finish, Pigtail Wires	1450 Lumens	1.44A - 1.76A	<input type="checkbox"/> <input type="radio"/>	2
P11-WRFP-1	Spreader Light, White & Red LED, White Finish, Pigtail Wires	825 Lumens	0.8A +0.3A red	<input type="checkbox"/> <input type="radio"/>	2

Custom connectors available upon request

Orion 6" LED Dome Light Model E200

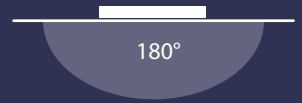

* White/red combo model

Features

- Ultra thin surface mount light
- Easy installation with two screws hidden under lens
- High performance - 720 Lumens
- Moisture resistant
- Available in bright or satin finished light body
- Night Vision – red/white LED combination also available

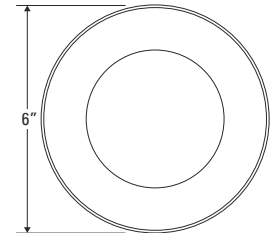
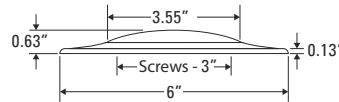

Part No.	Part Description	Amps	Color	Std Pack
E20-LA00-1	6" Interior Light Neutral White - Satin Trim Ring	0.50A - 0.70A	<input type="checkbox"/> <input type="radio"/>	5
E20-LC00-1	6" Interior Light Neutral White - Chrome Trim Ring		<input type="checkbox"/> <input type="radio"/>	5
E20-MA00-1	6" Interior Light Warm White - Satin Trim Ring		<input type="checkbox"/> <input type="radio"/>	5
E20-MC00-1	6" Interior Light Warm White - Chrome Trim Ring		<input type="checkbox"/> <input type="radio"/>	5
E20-WC00-1	6" Interior Light Cool White - Chrome Trim Ring		<input type="checkbox"/> <input type="radio"/>	5

For full list of part numbers see **pg 62**

Silho-X LED Area Lighting Model E060/E130/E110

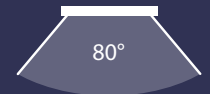

Features

- Shock proof, moisture-resistant design
- Reliable performance over 50,000 hours
- Extremely bright: produces
 - 380 lumens (4.00" model)
 - 190 lumens (2.75" model)
 - 65 lumens (1.50" model)
- Quickly mounts using
 - two #4 screws (1.50" & 2.75" models)
 - two #6 screws (4.00" models)
- High-polished stainless steel trim with other finishes available



* 4" and 2.75" models also available in white/red combination model

Part No.	Part Description	Amps	Color	Std Pack
E06-LS00-1	Silho-X 4" Round Neutral White Light SS Trim Ring	0.22A - 0.26A	<input type="checkbox"/> <input type="radio"/>	10
E06-MS00-1	Silho-X 4" Round Warm White Light SS Trim Ring		<input type="checkbox"/> <input type="radio"/>	10
E06-WS00-1	Silho-X 4" Round Cool White Light SS Trim Ring		<input type="checkbox"/> <input type="radio"/>	10
E13-LS00-1	Silho-X 2.75" Round Neutral White Light - SS Trim Ring	0.08A - 0.11A	<input type="checkbox"/> <input type="radio"/>	20
E13-MS00-1	Silho-X 2.75" Round Warm White Light - SS Trim Ring		<input type="checkbox"/> <input type="radio"/>	20
E13-WS00-1	Silho-X 2.75" Round Cool White Light - SS Trim Ring		<input type="checkbox"/> <input type="radio"/>	20
E11-LS00-1	Silho-X 1.5" Round Neutral White light - SS Trim Ring	0.07A - 0.09A	<input type="checkbox"/> <input type="radio"/>	10
E11-MS00-1	Silho-X 1.5" Round Warm White Light - SS Trim Ring		<input type="checkbox"/> <input type="radio"/>	10
E11-WS00-1	Silho-X 1.5" Round Cool White Light - SS Trim Ring		<input type="checkbox"/> <input type="radio"/>	10

For full list of part numbers see **pg 60**

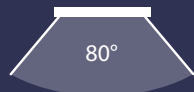

Silho-X LED Accent Lighting Model E130

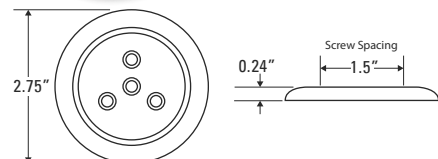

Features

- Extremely bright: produces 70 lumens per light
- Available in Black or White colored light body
- Shock proof and moisture-resistant design
- Reliable performance over 100,000 hours (color)
50,000 hours (white)
- Easy installation using just two #4 screws, neatly hidden behind lens

Part No.	Part Description	Amps	Color	Std Pack
E13-AB10-1	Silho-X 2.75" Round LP Amber Light - Black Trim Ring	0.03A - 0.05A		20
E13-BB10-1	Silho-X 2.75" Round LP Blue Light - Black Trim Ring	0.02A - 0.03A		20
E13-GB10-1	Silho-X 2.75" Round LP Green Light - Black Trim Ring	0.03A - 0.05A		20
E13-RB10-1	Silho-X 2.75" Round LP Red Light - Black Trim Ring	0.03A - 0.05A		20
E13-WB10-1	Silho-X 2.75" Round Cool White Light - Black Trim Ring	0.03A - 0.06A		20

For full list of part numbers see **pg 61**



3/4" Grommet Mount Accent Light Model E340

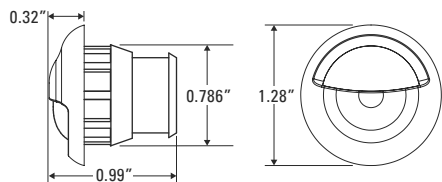
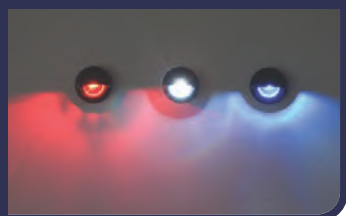

Features



- Light provides downward accent light
- Perfect for steps or walkways
- Water proof
- Easily mounts into a 3/4" hole
- Completely sealed IP68 rated design
- Include chemical resistant TPE grommet

Part No.	Part Description	Amps	Color	Std Pack
E34-BB00-1	E34 Step Light Grommet Mounted Blue W/ Black Cover	0.02A - 0.04A		100
E34-BC00-1	E34 Step Light Grommet Mounted Blue W/ Chrome Cover	0.06A - 0.08A		100
E34-RB00-1	E34 Step Light Grommet Mounted Red W/ Black Cover	0.07A - 0.09A		100
E34-RC00-1	E34 Step Light Grommet Mounted Red W/ Chrome Cover			100
E34-WB00-1	E34 Step Light Grommet Mounted White W/ Black Cover			100
E34-WC00-1	E34 Step Light Grommet Mounted White W/ Chrome Cover			100

For full list of part numbers see **pg 63**

Spring Mounted Dome Light Models E250/E260

NEW



* Available in 3" Model (E25)
and 4.5" Model (E26)

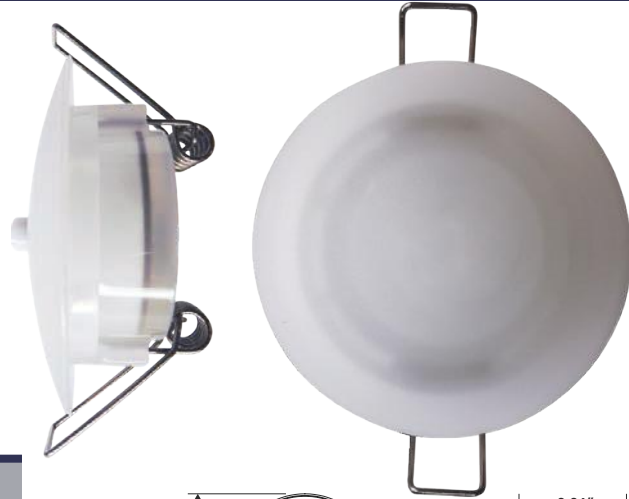

Features

- New spring mounted design comes in 3" and 4.5" sizes
- Moisture resistant and vibration proof
- Bright: 150 Lumens (3.0" model)
300 Lumens (4.5" model)
460 Lumens (4.5" premium model)
- Features diffused lens, clean low profile appearance
- Available with or without ON/OFF push button switch
- Reliable performance over 50,000 hours

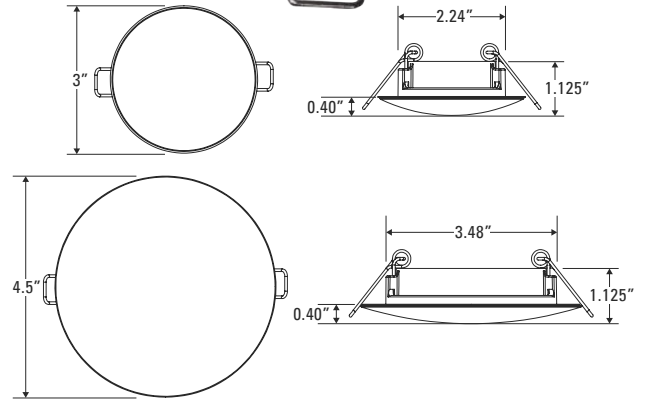

Part No.	Part Description	Amps	Color	Std Pack
E25-L000-1	3" Spring Mounted Dome Light, Neutral White	0.13A - 0.15A	<input type="checkbox"/> <input type="checkbox"/>	10
E25-L0S0-1	3" Spring Mounted Dome Light, Neutral White, w/Switch		<input type="checkbox"/> <input type="checkbox"/>	10
E25-M000-1	3" Spring Mounted Dome Light, Warm White		<input type="checkbox"/> <input type="checkbox"/>	10
E25-M0S0-1	3" Spring Mounted Dome Light, Warm White, w/Switch		<input type="checkbox"/> <input type="checkbox"/>	10
E25-W000-1	3" Spring Mounted Dome Light, Cool White		<input type="checkbox"/> <input type="checkbox"/>	10
E25-W0S0-1	3" Spring Mounted Dome Light, Cool White, w/Switch		<input type="checkbox"/> <input type="checkbox"/>	10
E26-L000-1	4.5" Spring Mounted Dome Light, Neutral White	0.25A - 0.31A	<input type="checkbox"/> <input type="checkbox"/>	10
E26-L0S0-1	4.5" Spring Mounted Dome Light, Neutral White, w/Switch		<input type="checkbox"/> <input type="checkbox"/>	10
E26-LP00-1	4.5" Spring Mounted Premium Dome Light, Neutral White	0.38A - 0.46A	<input type="checkbox"/> <input type="checkbox"/>	10
E26-LPS0-1	4.5" Spring Mounted Premium Dome Light, Neutral White, w/Switch		<input type="checkbox"/> <input type="checkbox"/>	10
E26-M000-1	4.5" Spring Mounted Dome Light, Warm White	0.25A - 0.31A	<input type="checkbox"/> <input type="checkbox"/>	10
E26-M0S0-1	4.5" Spring Mounted Dome Light, Warm White, w/Switch		<input type="checkbox"/> <input type="checkbox"/>	10
E26-MP00-1	4.5" Spring Mounted Premium Dome Light, Warm White	0.38A - 0.46A	<input type="checkbox"/> <input type="checkbox"/>	10
E26-MPS0-1	4.5" Spring Mounted Premium Dome Light, Warm White, w/Switch		<input type="checkbox"/> <input type="checkbox"/>	10
E26-W000-1	4.5" Spring Mounted Dome Light, Cool White	0.25A - 0.31A	<input type="checkbox"/> <input type="checkbox"/>	10
E26-W0S0-1	4.5" Spring Mounted Dome Light, Cool White, w/Switch		<input type="checkbox"/> <input type="checkbox"/>	10
E26-WP00-1	4.5" Spring Mounted Premium Dome Light, Cool White	0.38A - 0.46A	<input type="checkbox"/> <input type="checkbox"/>	10
E26-WPS0-1	4.5" Spring Mounted Premium Dome Light, Cool White, w/Switch		<input type="checkbox"/> <input type="checkbox"/>	10

For full list of part numbers see **pg 62**

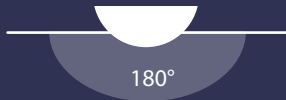
NEW

Surface Mounted Dome Light Models E270/E280



* Available in 3" Model (E27)
and 4.5" Model (E28)

Features

- Surface mounted for easy installation – requires 3/8" wire hole
- 4.5" Premium model available
- Bright: 175 Lumens (3.0" model)
350 Lumens (4.5" model)
525 Lumens (4.5" premium model)
- 4.5" model available with or without ON/OFF push button switch
- Three mounting screws concealed by trim ring.
- Reliable performance over 50,000 hours

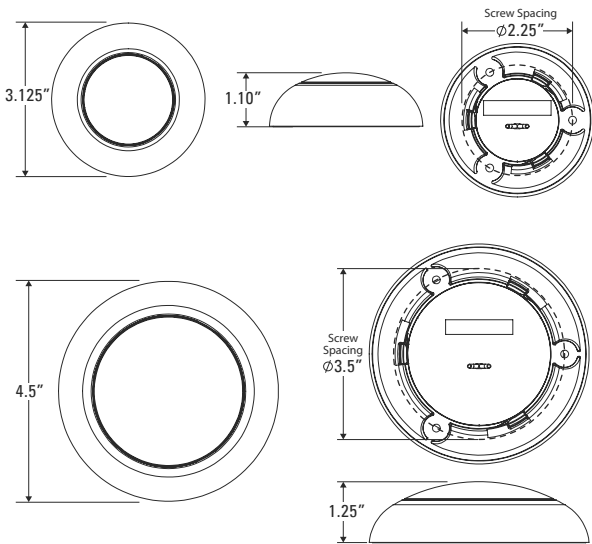

Part No.	Part Description	Amps	Color	Std Pack
E27-L000-1	3" Surface Mounted Dome Light, Neutral White		<input type="checkbox"/> <input type="checkbox"/>	10
E27-M000-1	3" Surface Mounted Dome Light, Warm White	0.13A - 0.15A	<input type="checkbox"/> <input type="checkbox"/>	10
E27-W000-1	3" Surface Mounted Dome Light, Cool White		<input type="checkbox"/> <input type="checkbox"/>	10
E28-L000-1	4.5" Surface Mounted Dome Light, Neutral White		<input type="checkbox"/> <input type="checkbox"/>	10
E28-L0S0-1	4.5" Surface Mounted Dome Light, Neutral White, w/Switch	0.25A - 0.31A	<input type="checkbox"/> <input type="checkbox"/>	10
E28-LP00-1	4.5" Surface Mounted Premium Dome Light, Neutral White		<input type="checkbox"/> <input type="checkbox"/>	10
E28-LPS0-1	4.5" Surface Mounted Premium Dome Light, Neutral White, w/Switch	0.38A - 0.46A	<input type="checkbox"/> <input type="checkbox"/>	10
E28-M000-1	4.5" Surface Mounted Dome Light, Warm White		<input type="checkbox"/> <input type="checkbox"/>	10
E28-M0S0-1	4.5" Surface Mounted Dome Light, Warm White, w/Switch	0.25A - 0.31A	<input type="checkbox"/> <input type="checkbox"/>	10
E28-MP00-1	4.5" Surface Mounted Premium Dome Light, Warm White		<input type="checkbox"/> <input type="checkbox"/>	10
E28-MPS0-1	4.5" Surface Mounted Premium Dome Light, Warm White, w/Switch	0.38A - 0.46A	<input type="checkbox"/> <input type="checkbox"/>	10
E28-W000-1	4.5" Surface Mounted Dome Light, Cool White		<input type="checkbox"/> <input type="checkbox"/>	10
E28-W0S0-1	4.5" Surface Mounted Dome Light, Cool White, w/Switch	0.25A - 0.31A	<input type="checkbox"/> <input type="checkbox"/>	10
E28-WP00-1	4.5" Surface Mounted Premium Dome Light, Cool White		<input type="checkbox"/> <input type="checkbox"/>	10
E28-WPS0-1	4.5" Surface Mounted Premium Dome Light, Cool White, w/Switch	0.38A - 0.46A	<input type="checkbox"/> <input type="checkbox"/>	10

For full list of part numbers see **pg 63**

Recessed High Output Dome Light Model E300

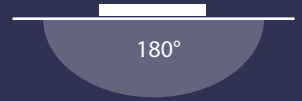

* Pictured with rocker switch

Features



- Powerful 1050-2100 lumen output
- Available with 21 or 42 LEDs that minimize bright spots and reduce shadows
- Excellent replacement for fluorescent light fixtures
- Red/white combination lamps are available for tactical vision applications
- Moisture-resistant, vibration proof light design
- NFPA and Triple K compliant
- White powder coated finish
- Hi/Low illumination output

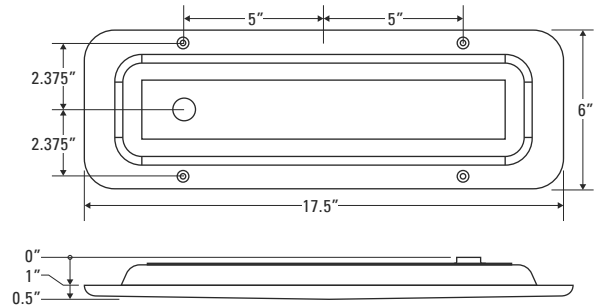

Part No.	Part Description	Amps	Color	Std Pack
E30-L000-1	Recessed 4K White 42 LED Light 6"x17.5"	1.30A - 1.90A	<input type="checkbox"/> <input type="checkbox"/>	12
E30-L00R-1	Recessed 4K White/Red 42/16 LED Light 6"x17.5"	1.90A / 0.8A(Red)	<input checked="" type="checkbox"/> <input type="checkbox"/>	12
E30-L0S0-1	Recessed 4K White 42 LED Light 6"x17.5" Switched	1.30A - 1.90A	<input type="checkbox"/> <input type="checkbox"/>	12
E30-L0SR-1	Recessed 4K White/Red 42/16 LED Light 6"x17.5" Switched	1.90A / 0.8A(Red)	<input checked="" type="checkbox"/> <input type="checkbox"/>	12

For full list of part numbers see **pg 63**



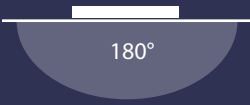

Recessed High Output Dome Light Model E310



*Pictured with motion detector

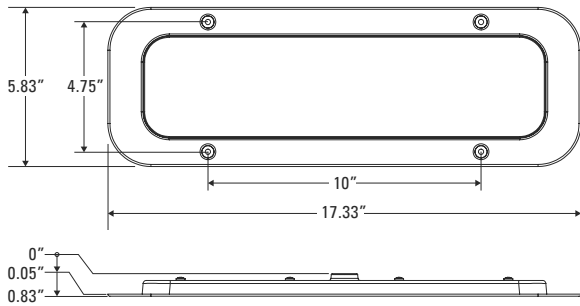

Features



- New easy Installation Design
- Available light options include: Motion Detection Sensor, Integrated ON/OFF switch
- Moisture-resistant, vibration proof design
- NFPA and Triple K compliant
- Powerful 2100 lumen output
- Excellent replacement for fluorescent light fixtures
- White powder coated finish
- Hi/Low illumination output

Part No.	Part Description	Amps	Color	Std Pack
E31-LOMB-1	Recessed 4K White 32 LED Light 6"x17.5" w/Motion Detection .180 Bullet	1.49 - 1.82A	<input type="checkbox"/> <input type="checkbox"/>	12
E31-L00B-1	Recessed 4K White 32 LED Light 6"x17.5" .180 Bullet Connectors		<input type="checkbox"/> <input type="checkbox"/>	12



Surface Mount Linear LED Light Model E350/E360/E380



Features

- Slim light design, perfect for under counter applications
- Reliable performance over 50,000 hours
- At 12V produces
 - 750 lumens (13")
 - 1500 lumens (20")
 - 3000 lumens (35")
- Shock proof and moisture-resistant construction
- Easy replacement for fluorescent light fixtures
- 180° wide light-beam illuminates large area
- Quick and easy mounting with two screws

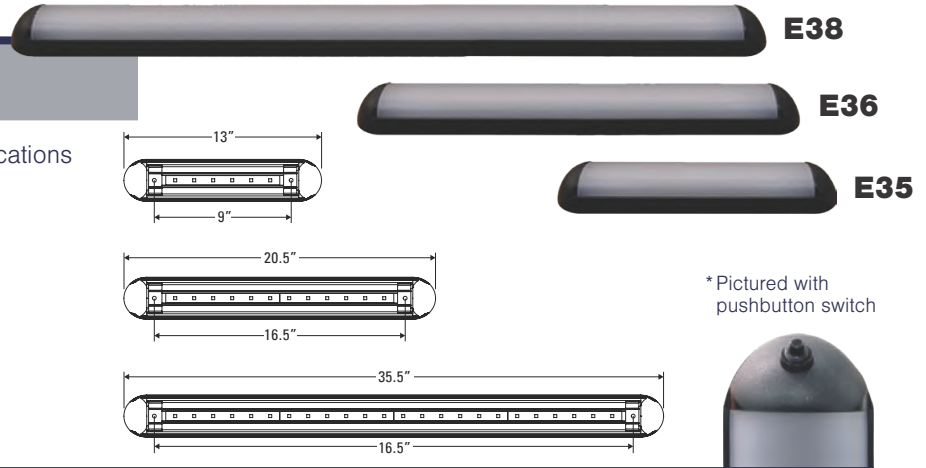

Part No.	Part Description	Amps	Color	Std Pack
E35-LB00-1	Linear LED SM Light Neutral White Black Body 9W		<input type="checkbox"/> <input type="checkbox"/>	10
E35-MB00-1	Linear LED SM Light Warm White Black Body 9W	0.51A - 0.62A	<input type="checkbox"/> <input type="checkbox"/>	10
E35-WB00-1	Linear LED SM Light Cool White Black Body 9W		<input type="checkbox"/> <input type="checkbox"/>	10
E36-LB00-1	Linear LED SM Light Neutral White Black Body 18W		<input type="checkbox"/> <input type="checkbox"/>	10
E36-MB00-1	Linear LED SM Light Warm White Black Body 18W	1.05A - 1.28A	<input type="checkbox"/> <input type="checkbox"/>	10
E36-WB00-1	Linear LED SM Light Cool White Black Body 18W		<input type="checkbox"/> <input type="checkbox"/>	10
E38-LB00-1	Linear LED SM Light Neutral White Black Body 36W		<input type="checkbox"/> <input type="checkbox"/>	10
E38-MB00-1	Linear LED SM Light Warm White Black Body 36W	1.88A - 2.29A	<input type="checkbox"/> <input type="checkbox"/>	10
E38-WB00-1	Linear LED SM Light Cool White Black Body 36W		<input type="checkbox"/> <input type="checkbox"/>	10

For full list of part numbers see **pg 64**

Fluorescent Light LED Conversion Kit Model E390



*White/red combination available

* Easy-to-install adhesive backing



Features

- Winner of the 2015 EMS World Innovation Award
- LED replacement for fluorescent lighting fixture
- Long lasting: 50,000 hour service life
- Extremely bright: produces
 - 700 lumens (12")
 - 1400 lumens (18")

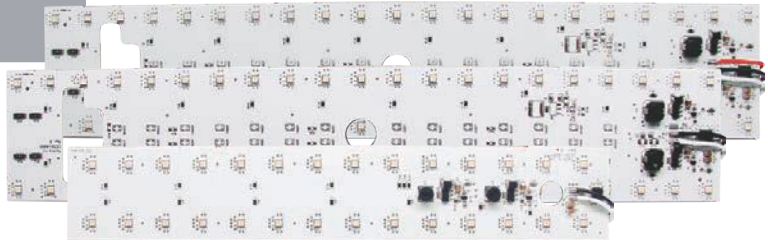

Part No.	Part Description	Amps	Color	Std Pack
E39-L000-1	LED Neutral White Light Replacement Kit for P716 & P718	2.0A - 2.68A	<input type="checkbox"/> <input type="checkbox"/>	10
E39-L00R-1	LED Neutral White/Red Combo Light Repl Kit for P716 & P718	2.68A / 0.42A(Red)	<input type="checkbox"/> <input type="checkbox"/>	10
E39-L010-1	LED Neutral White Light Replacement Kit for 712XL	1.37A - 1.86A	<input type="checkbox"/> <input type="checkbox"/>	10

8" Recessed Interior Light Model E070

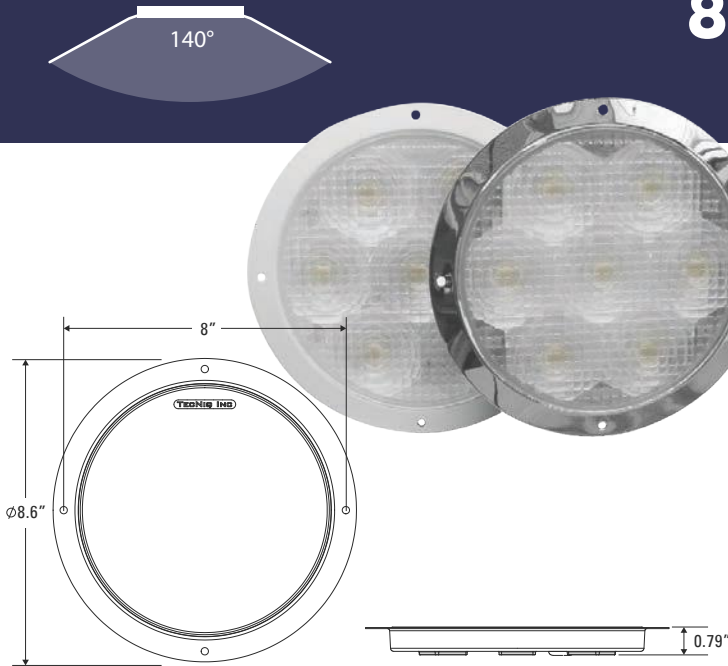

Features

- Excellent interior illumination
- Vibration proof, moisture resistant design
- Exceeds Triple K requirements
- Reliable performance over 50,000 hours
- Produces 840 lumens
- High quality LEDs that won't change color over time

Part No.	Part Description	Amps	Color	Std Pack
E07-WC00-1	8" EV Recessed Cool White LED w/ Chrome Trim Ring	1.00A - 1.35A	 	10

For full list of part numbers see **pg 60**



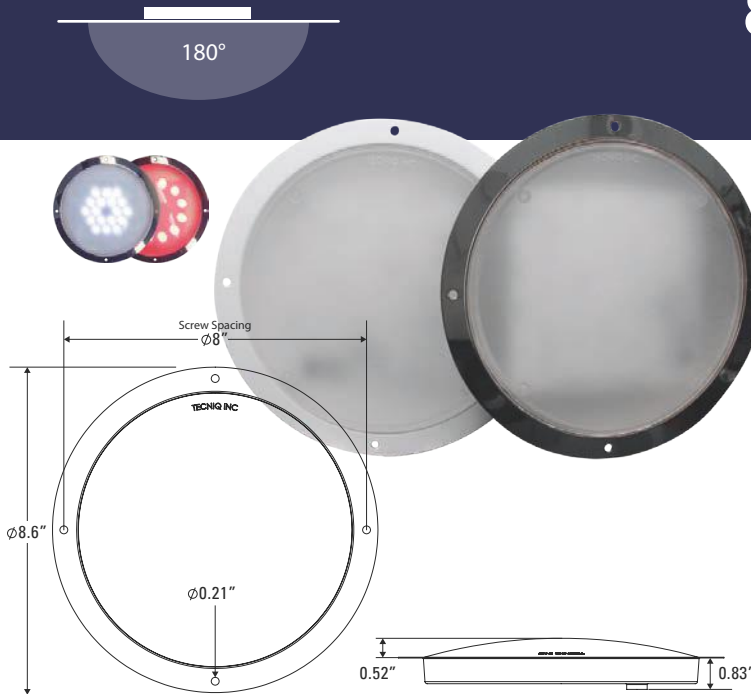

8" Recessed Dome Light Model E080



Features



- Excellent interior illumination
- Vibration proof, moisture resistant design
- NFPA and Triple K compliant
- Reliable performance over 50,000 hours
- Powerful output of 1000 (18 LED) or 1500 (31 LED) lumens illuminates a wide area
- 12VDC and 24VDC
- AccuColor LEDs provide superior color rendering for more natural skin tones to facilitate a more accurate diagnosis in medical lighting situations
- Smooth lens is easy to wipe clean

Part No.	Part Description	Amps	Color	Std Pack
E08-LC00-1	8" EV Neutral White Interior Light Chrome Trim - 31 LEDs	1.12A - 1.52A	 	10
E08-LCR0-1	8" EV Neutral White/Red Interior Light Chrome Trim - 18/12 LED	1.52A / 0.4A(Red)	 	10
E08-WC00-1	8" EV Cool White Interior Light Chrome Trim - 31 LEDs	1.12A - 1.52A	 	10
E08-WCR0-1	8" EV Cool White/Red Interior Light Chrome Trim - 18/12 LED	1.52A / 0.4A(Red)	 	10

For full list of part numbers see **pg 60**

Surface-Mounted Dome Light Model E160

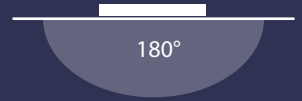

Features



- Lamp features six high efficiency LEDs, providing
- Over 300 lumens
- Sleek and stylish surface mount design
- Available with or without integrated on/off switch
- Installs with just 4 screws hidden behind lens
- White or black base available

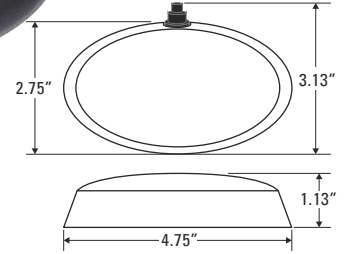

* Available with or without integrated power switch

Part No.	Part Description	Amps	Color	Std Pack
E16-LW00-1	E16 Interior SM Neutral White Oval Light White Base	0.18A - 0.23A	<input type="checkbox"/> <input type="radio"/>	20
E16-LWS0-1	E16 Interior SM Neutral White Oval Light White Base w/Switch		<input type="checkbox"/> <input type="radio"/>	20
E16-MW00-1	E16 Interior SM Warm White Oval Light White Base		<input type="checkbox"/> <input type="radio"/>	20
E16-MWS0-1	E16 Interior SM Warm White Oval Light White Base w/Switch		<input type="checkbox"/> <input type="radio"/>	20
E16-WW00-1	E16 Interior SM Cool White Oval Light White Base		<input type="checkbox"/> <input type="radio"/>	20
E16-WWS0-1	E16 Interior SM Cool White Oval Light White Base w/Switch		<input type="checkbox"/> <input type="radio"/>	20

For full list of part numbers see **pg 61**

4.5" LED Utility Light Model E180

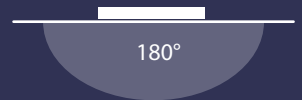

Features

- Surface mounted for ease of installation – requires one 3/8" wire hole
- Vibration proof, moisture-resistant design
- Reliable performance over 50,000 hours
- Lamp output of 800 lumens
- Made with high grade polycarbonate, for excellent optic quality and impact resistance



* Available with or without integrated power switch

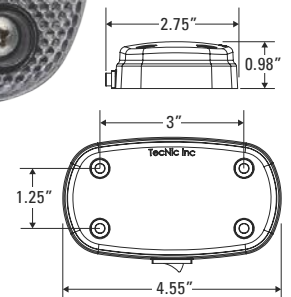

Part No.	Part Description	Amps	Color	Std Pack
E18-LC00-1	Surface mount 4.5"x2.5" Neutral White 12 LED Dome light	0.54A - 0.66A	<input type="checkbox"/> <input type="radio"/>	10
E18-LCS0-1	Surface mount 4.5"x2.5" Neutral White 12 LED Dome light w/ Switch		<input type="checkbox"/> <input type="radio"/>	10
E18-WC00-1	Surface mount 4.5"x2.5" Cool White 12 LED Dome light		<input type="checkbox"/> <input type="radio"/>	10
E18-WCS0-1	Surface mount 4.5"x2.5" Cool White 12 LED Dome light w/ Switch		<input type="checkbox"/> <input type="radio"/>	10

For full list of part numbers see **pg 62**

NEW

Surface Mount Area Light Model E050



*White Cover

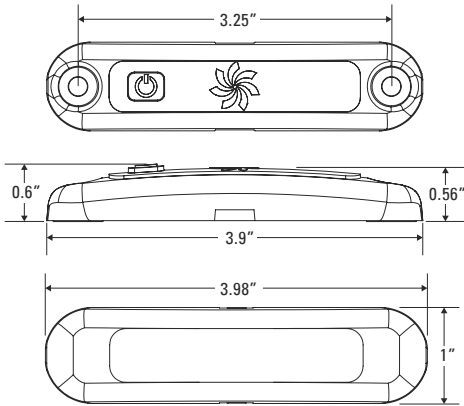

*Cover Dimensions

Features



- Integrated On/Off Switch
- Available with 316 stainless steel or high-impact molded in color covers
- Great appearance with hidden fasteners
- Provides 220 lumens of brightness
- Can be mounted on flat or 1" round bar surfaces (w/ available adapter)

Part No.	Part Description	Amps	Color	Std Pack
E05-WSS0-1	Interior Area Light, Surface Mt.,White LED, SS Cover	0.13A - 0.18A	<input type="checkbox"/> <input type="checkbox"/>	10
E05-WBS0-1	Interior Area Light, Surface Mt.,White LED, Black Cover		<input type="checkbox"/> <input type="checkbox"/>	10
E05-WWS0-1	Interior Area Light, Surface Mt.,White LED, White Cover		<input type="checkbox"/> <input type="checkbox"/>	10
E05-0B00-1	Interior Area Light - 1" Round Bar Mt. Adapter			10

For full list of part numbers see **pg 59**

4" Round Dome Light Model T440

180°

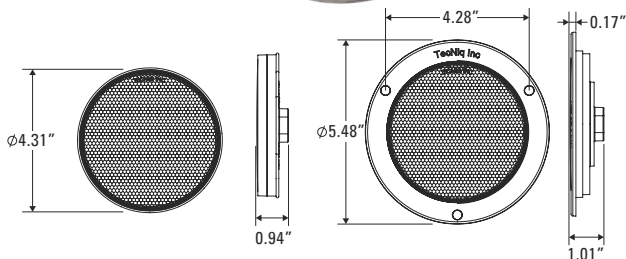

Features



- High output dome light - 480 lumens
- Low amp draw - 0.25A at 12VDC
- Guaranteed waterproof, sealed body that is immune to shock and vibration
- Reliable performance over 50,000 hours
- Produces 480 lumens
- Standard grommet or flange mount models

Part No.	Part Description	Amps	Color	Std Pack
T44-WD0B-1	4" Round 8 LED Grommet Mount Dome Light w/ .180 Bullets	0.35A - 0.48A	<input type="checkbox"/> <input type="checkbox"/>	100
T44-WDFB-1	4" Round 8 LED Flange Mount Dome Light w/ .180 Bullets		<input type="checkbox"/> <input type="checkbox"/>	100

LED Spot/Flood Light Model E600

NEW

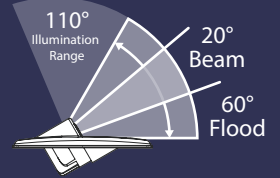

Features



- Combines great appearance with powerful performance of 2000 lumens each
- Waterproof design, made with our TecSeal Urethane potting
- Anodized cast aluminum heatsink
- 316 Stainless steel cover
- Form fitting TPE gasket to protect the boat finish

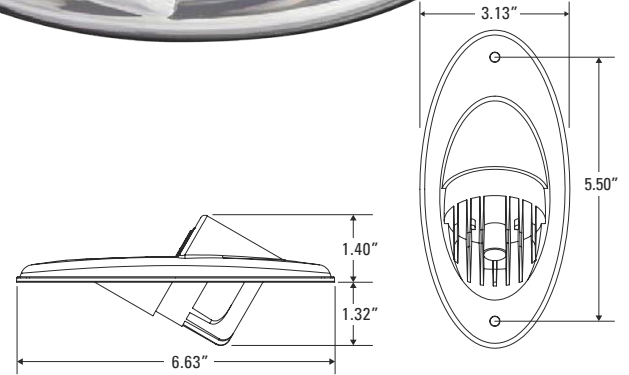

Part No.	Part Description	Amps	Color	Std Pack
E60-WS20-1	Recessed Mount LED Docking Light, Pair	1.25A - 1.75A	<input type="checkbox"/> <input type="radio"/>	6

LED Spot/Flood Light Model E610

NEW

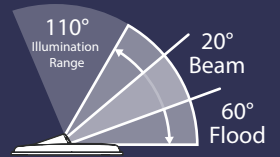

Features



- Surface mount design is perfect for pontoons and fishing boats
- 1400 Lumen output per light
- Waterproof design, made with our TecSeal Urethane potting
- Anodized cast aluminum heatsink
- 316 Stainless steel cover
- Form fitting TPE gasket to protect the boat finish
- Excellent forward to side of boat illumination

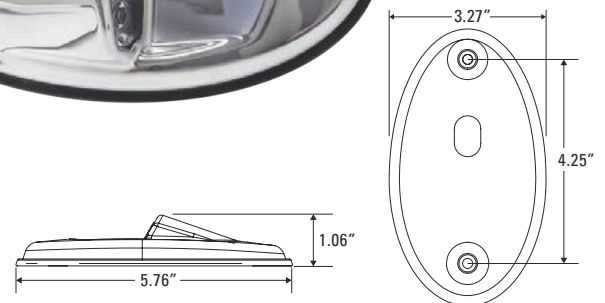

Part No.	Part Description	Amps	Color	Std Pack
E61-WS00-1	Surface Mount LED Docking Light, Pair	0.85A - 1.15A	<input type="checkbox"/> <input type="radio"/>	6

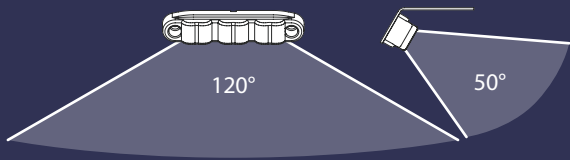

6.5" LED Floodlight Model E100

* Bracket sits at a 120° angle

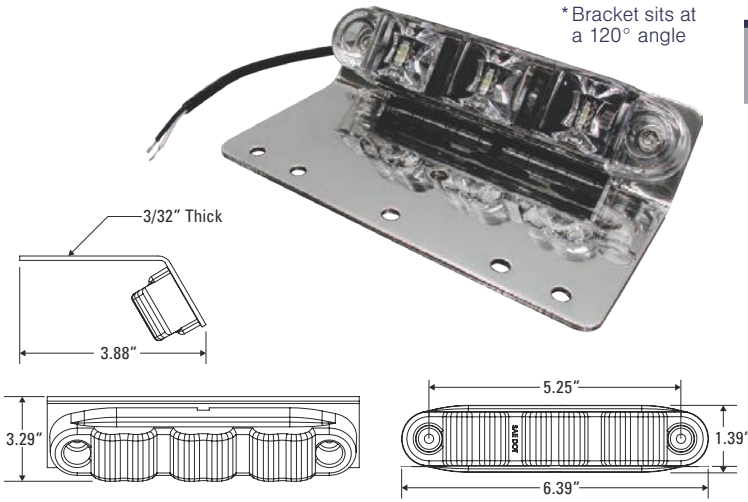

Features

- Extra wide area of illumination (120° x 50°) covers many applications: task lighting, load lamp, ground lighting, panel lighting, and more
- TecSeal Urethane Potting - Guaranteed Circuit Board Protection
- Waterproof light that is immune to vibration
- Reliable performance over 50,000 hours
- Powerful multi-chip LEDs create 675 lumens
- Durable construction that can withstand the harshest conditions
- Available with or without the stainless steel mounting bracket

Part No.	Part Description	Amps	Color	Std Pack
E10-W000-1	EV Ground/Pump Panel Light	0.36A - 0.44A	<input type="checkbox"/> <input type="checkbox"/>	10
E10-WS00-1	EV Ground/Pump Panel Light with SS Bracket		<input type="checkbox"/> <input type="checkbox"/>	10

For full list of part numbers see **pg 60**

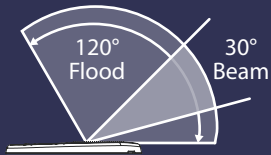

LED Spot/Flood Light Model E960

* Pictured on Ambulance as supplemental reverse light



Features

- Surface mount design increases your mounting options and eliminates large oval holes in your hull
- Produces 900 lumens per light
- Waterproof design, made with our TecSeal Urethane potting
- 316 Stainless Steel Covers
- Anodized, die-cast, marine-grade, aluminum body
- Primary spot output is 30° from mounting surface
- Secondary rectangular flood output used for area illumination

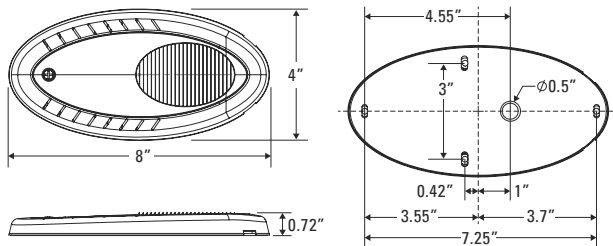

Part No.	Part Description	Amps	Color	Std Pack
E96-WS00-1	Docking Light TecNiq, Pair	0.45A - 0.55A	<input type="checkbox"/> <input type="checkbox"/>	12

For full list of part numbers see **pg 65**

5" x 3.3" Emergency Flasher Model K400



Features



- Powerful 5" x 3.3" warning lamp fits standard mounting holes
- Patent-pending AutoSync technology means all TecNiq flashers are synchronized without requiring a separate control box
- Steady burn model also available for all colors
- TecSeal Urethane Potting - Guaranteed Circuit Board Protection
- Durable impact resistant lens
- Excellent UV Resistance - Automotive exterior lighting grade polycarbonate
- IP68 Rated for long-term dust and water-intrusion proof
- Meets all NFPA 1901 and Triple K specifications, including upcoming regulations

* Chrome or black bezel and gasket kit sold separately

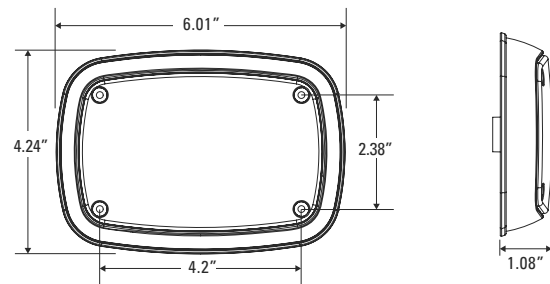

Part No.	Part Description	Amps	Color	Std Pack
K40-0100-1	K40 K50 Anchor/Screw Kit			1
K40-1B00-1	K40 Black Trim Ring and Gasket			1
K40-1C00-1	K40 Chrome Trim Ring and Gasket			1
K40-AA00-1	K40 AutoSync Amber Flasher Lamp Amber Lens	2.20A - (1.10A avg)		1
K40-BB00-1	K40 AutoSync Blue Flasher Lamp Blue Lens			1
K40-GG00-1	K40 AutoSync Green Flasher Lamp Green Lens			1
K40-RR00-1	K40 AutoSync Red Flasher Lamp Red Lens			1
K40-WC00-1	K40 AutoSync White Flasher Lamp Clear Lens			1
K40-AAS0-1	K40 Steady Amber Flasher Lamp Amber Lens	2.20A		1
K40-BBS0-1	K40 Steady Blue Flasher Lamp Blue Lens			1
K40-GGS0-1	K40 Steady Green Flasher Lamp Green Lens			1
K40-RRS0-1	K40 Steady Red Flasher Lamp Red Lens			1
K40-WCS0-1	K40 Steady White Flasher Lamp Clear Lens			1
K40-AR00-1	K40 AutoSync Amber Red Combo Flasher Lamp Clear Lens	1.10A alternating between colors		1
K40-BR00-1	K40 AutoSync Blue Red Combo Flasher Lamp Clear Lens			1
K40-WA00-1	K40 AutoSync White Amber Combo Flasher Lamp Clear Lens			1
K40-WB00-1	K40 AutoSync White Blue Combo Flasher Lamp Clear Lens			1
K40-WR00-1	K40 AutoSync White Red Combo Flasher Lamp Clear Lens			1

For full list of part numbers see **pg 65**

5" x 2" Emergency Flasher Model K500





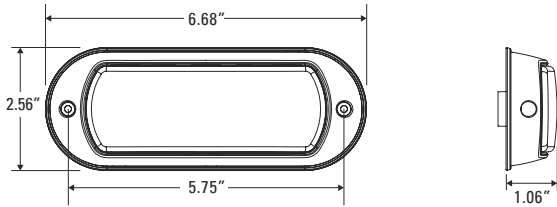

























* Chrome or black bezel and gasket kit sold separately



Features



- Powerful 5"x 2" warning lamp fits standard mounting holes
- Patent-pending AutoSync technology means all TecNiq flashers are synchronized without requiring a separate control box
- Steady burn model also available for all colors
- TecSeal Urethane Potting - Guaranteed Circuit Board Protection
- Durable impact resistant lens
- Excellent UV Resistance - Automotive exterior lighting grade polycarbonate
- IP68 Rated for long-term dust and water-intrusion proof
- Meets all NFPA 1901 and Triple K specifications, including upcoming regulations

Part No.	Part Description	Amps	Color	Std Pack
K40-0100-1	K40 K50 Anchor/Screw Kit			1
K50-1B00-1	K50 Black Trim and Gasket Kit			1
K50-1C00-1	K50 Chrome Trim and Gasket Kit			1
K50-AA00-1	K50 AutoSync Amber Flasher Lamp Amber Lens	1.80A - (0.90A avg)	 	1
K50-BB00-1	K50 AutoSync Blue Flasher Lamp Blue Lens		 	1
K50-GG00-1	K50 AutoSync Green Flasher Lamp Green Lens		 	1
K50-RR00-1	K50 AutoSync Red Flasher Lamp Red Lens		 	1
K50-WC00-1	K50 AutoSync White Flasher Lamp Clear Lens		 	1
K50-AAS0-1	K50 Steady Amber Flasher Lamp Amber Lens	1.80A	 	1
K50-BBS0-1	K50 Steady Blue Flasher Lamp Blue Lens		 	1
K50-GGS0-1	K50 Steady Green Flasher Lamp Green Lens		 	1
K50-RRS0-1	K50 Steady Red Flasher Lamp Red Lens		 	1
K50-WCS0-1	K50 Steady White Flasher Lamp Clear Lens		 	1
K50-AR00-1	K50 AutoSync Amber Red Combo Flasher Lamp Clear Lens	0.90A alternating between colors	 	1
K50-BR00-1	K50 AutoSync Blue Red Combo Flasher Lamp Clear Lens		 	1
K50-WB00-1	K50 AutoSync White Blue Combo Flasher Lamp Clear Lens		 	1
K50-WR00-1	K50 AutoSync White Red Combo Flasher Lamp Clear Lens		 	1

For full list of part numbers see **pg 66**

6" x 4" Emergency Flasher Model K600

Features









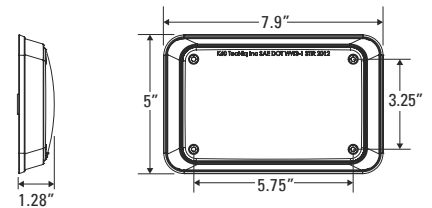























- Powerful 6" x 4" warning lamp fits standard mounting holes
- Patent-pending AutoSync technology means all TecNiq flashers are synchronized without requiring a separate control box
- Steady burn model also available for all colors
- Sequential arrow pattern available
- TecSeal Urethane Potting - Guaranteed Circuit Board Protection
- Durable impact resistant lens
- Excellent UV Resistance - Automotive exterior lighting grade polycarbonate
- IP68 Rated for long-term dust and water-intrusion proof
- Meets all NFPA 1901 and Triple K specifications, including upcoming regulations
- DOT stop/tail/turn reverse lamp compliance mode available on all lamps



* Chrome or black bezel and gasket kit sold separately



Part No.	Part Description	Amps	Color	Std Pack
K70-0100-1	K60 K70 Anchor/Screw Kit			1
K60-1B00-1	K60 Black Trim and Gasket Kit			1
K60-1C00-1	K60 Chrome Trim and Gasket Kit			1
K60-AA00-1	K60 AutoSync Amber Flasher Lamp Amber Lens	2.50A – (1.25A avg)	 	1
K60-BB00-1	K60 AutoSync Blue Flasher Lamp Blue Lens		 	1
K60-GG00-1	K60 AutoSync Green Flasher Lamp Green Lens		 	1
K60-RR00-1	K60 AutoSync Red Flasher Lamp Red Lens		 	1
K60-WC00-1	K60 AutoSync White Flasher Lamp		 	1
K60-AAS0-1	K60 Steady Amber Flasher Amber Lens	2.50A	 	1
K60-BBS0-1	K60 Steady Blue Flasher Blue Lens		 	1
K60-GGS0-1	K60 Steady Green Flasher Green Lens		 	1
K60-RRS0-1	K60 Steady Red Flasher Red Lens		 	1
K60-WCS0-1	K60 Steady White Flasher Clear Lens		 	1
K60-AAA0-1	K60 AutoSync Amber Flasher Lamp Amber Lens Arrow Mask	0.33A	 	1
K60-A3S0-1	K60 Steady Burn Amber LEDs, Amber turn, Arrow Mask		 	1
K60-AAT0-1	K60 Steady Amber Turn Amber Lens		 	1
K60-WBU0-1	K60 White Backup Lamp	0.27A	 	1
K60-STR0-1	K60 Steady Red STT Red Lens	0.33A	 	1

For full list of part numbers see **pg 66**

7" x 3" Emergency Flasher Model K700



* Chrome or black bezel and gasket kit sold separately

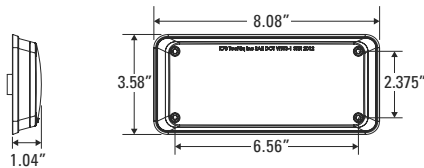

Features



- Powerful 7" x 3" warning lamp fits standard mounting holes
- Patent-pending AutoSync technology means all TecNiq flashers are synchronized without requiring a separate control box
- Steady burn model also available for all colors
- TecSeal Urethane Potting - Guaranteed Circuit Board Protection
- Durable impact resistant lens
- Excellent UV Resistance - Automotive exterior lighting grade polycarbonate
- IP68 Rated for long-term dust and water-intrusion proof
- Meets all NFPA 1901 and Triple K specifications, including upcoming regulations
- DOT stop/tail/turn/reverse lamp compliance mode available on all lamps

Part No.	Part Description	Amps	Color	Std Pack
K70-0100-1	K60 K70 Anchor/Screw Kit			1
K70-1B00-1	K70 Black Trim and Gasket Kit			1
K70-1C00-1	K70 Chrome Trim and Gasket Kit			1
K70-AA00-1	K70 AutoSync Amber Flasher Lamp Amber Lens	2.50A - (1.25A avg)		1
K70-BB00-1	K70 AutoSync Blue Flasher Lamp Blue Lens			1
K70-GG00-1	K70 AutoSync Green Flasher Green Lens			1
K70-RR00-1	K70 AutoSync Red Flasher Lamp Red Lens			1
K70-WC00-1	K70 AutoSync White Flasher Lamp			1
K70-AAS0-1	K70 Steady Amber Flasher Amber Lens	2.50A		1
K70-BBS0-1	K70 Steady Blue Flasher Lamp Blue Lens			1
K70-GGS0-1	K70 Steady Green Flasher Green Lens			1
K70-RRS0-1	K70 Steady Red Flasher Red Lens			1
K70-WCS0-1	K70 Steady White Flasher Clear Lens			1
K70-AAT0-1	K70 Steady Amber Turn Amber Lens	0.22A		1
K70-WBU0-1	K70 White Backup Lamp	0.14A		1
K70-STR0-1	K70 Steady Red STT Red Lens	0.23A		1

For full list of part numbers see **pg 67**

9" x 7" Emergency Flasher Model K900

Features



- Powerful 9" x 7" warning lamp fits standard mounting holes
- K900 can be purchased as Flasher/Scene Light combination
- Patent-pending AutoSync technology means all TecNiq flashers are synchronized without requiring a separate control box
- TecSeal Urethane Potting - Guaranteed Circuit Board Protection
- Durable impact resistant lens
- Excellent UV Resistance - Automotive exterior lighting grade polycarbonate
- IP68 Rated for long-term dust and water-intrusion proof
- Meets all NFPA 1901 and Triple K specifications, including upcoming regulations
- DOT stop/tail/turn/reverse lamp compliance mode available on all lamps



* Chrome or black bezel and gasket kit sold separately

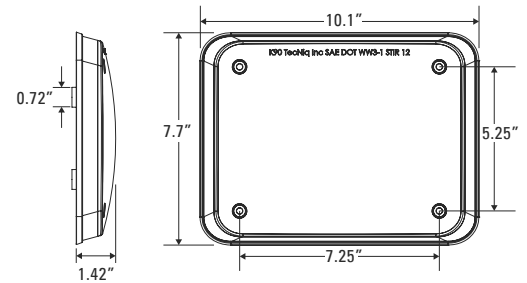

Part No.	Part Description	Amps	Color	Std Pack
K90-0100-1	K90 Anchor/Screw Kit			1
K90-1B00-1	K90 Black Trim and Gasket Kit			1
K90-1C00-1	K90 Chrome Trim and Gasket Kit			1
K90-AA00-1	K90 AutoSync Amber Flasher Lamp Amber Lens	5.00A – (2.50A avg)		1
K90-BB00-1	K90 AutoSync Blue Flasher Lamp Blue Lens			1
K90-GG00-1	K90 AutoSync Green Flasher Lamp Green Lens			1
K90-RR00-1	K90 AutoSync Red Flasher Lamp Red Lens			1
K90-WC00-1	K90 AutoSync White Flasher Lamp Clear Lens			1
K90-RA00-1	K90 AutoSync Red Amber Flasher Lamp Clear Lens	2.50A each side		1
K90-RB00-1	K90 AutoSync Red Blue Flasher Lamp Clear Lens			1
K90-RW00-1	K90 AutoSync Red White Flasher Lamp Clear Lens			1
K90-WB00-1	K90 AutoSync White Blue Flasher Lamp Clear Lens			1
K90-AAS0-1	K90 Steady Amber Flasher Lamp Amber Lens	5.00A		1
K90-BBS0-1	K90 Steady Blue Flasher Lamp Blue Lens			1
K90-GGS0-1	K90 Steady Green Flasher Lamp Green Lens			1
K90-RRS0-1	K90 Steady Red Flasher Lamp Red Lens			1
K90-WCS0-1	K90 Steady White Flasher Lamp Clear Lens			1
K90-RAS0-1	K90 Steady Red Amber Flasher Lamp Clear Lens	2.50A each side		1
K90-RBS0-1	K90 Steady Red Blue Flasher Lamp Clear Lens			1
K90-RWS0-1	K90 Steady Red White Flasher Lamp Clear Lens			1
K90-WBS0-1	K90 Steady White Blue Flasher Lamp Clear Lens			1
K90-WBU0-1	K90 White Backup Lamp	0.28A		1
K90-AAT0-1	K90 Steady Amber Turn Amber Lens	0.44A		1
K90-STRO-1	K90 Steady Red STT Lamp Red Lens	0.46A		1

For full list of part numbers see **pg 68**

Emergency Scene Lighting Model K900/K700/K600

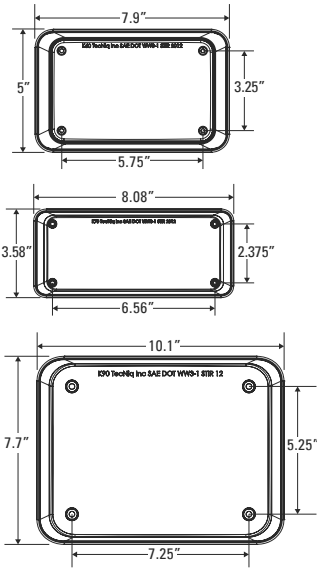

*K900 style output beam exceeds all ground specifications on small vehicles with a single lamp

Features



- Light beam from horizontal to the base of the vehicle ensures continual ground coverage
- 5000K LEDs provide natural color balance
- K900 can be purchased as Flasher/Scene Light combination
- IP68 Rated for long-term dust and water-intrusion proof
- Meets all NFPA 1901 and Triple K specifications, including upcoming regulations
- Powerful TecNiq scene lighting fits standard mounting holes for easy upgrade

Part No.	Part Description	Amps	Color	Std Pack
K60-SW00-1	K60 High Output Scene Light	1.10A - 1.30A	<input type="checkbox"/> <input type="radio"/>	1
K70-SW00-1	K70 High Output Scene Light	1.40A - 1.80A	<input type="checkbox"/> <input type="radio"/>	1
K90-SW00-1	K90 High Output Scene Light	2.90A - 3.50A	<input type="checkbox"/> <input type="radio"/>	1
K90-RS00-1	K90 AutoSync Red Flasher White Scene Clear Lens	1.6A / 1.3 avg(Red)	<input checked="" type="checkbox"/> <input type="radio"/>	1
K90-ST00-1	K90 Steady Red STT Bottom Scene Clear Lens	1.6A / 0.23A(Red)	<input checked="" type="checkbox"/> <input type="radio"/>	1

AutoSync Technology

TecNiq AutoSync uses a high accuracy internal timer (patent pending) to synchronize light modules over a wide temperature range and many hours of continuous use. These lamps do not require an external circuit to provide a synchronization signal, the moment of power-on is all that is required to guarantee properly synchronized flashing for hours of continuous operation. Lamps are re-synchronized each time power is applied.

Changing Flash Patterns

Each time the white wire is connected to the 12V power supply, the lamp will restart counting from pattern 1. To select flash pattern, tap white wire on 12V power supply the number of times corresponding to the desired flash pattern. (see list below)

Allow flasher to complete 5 cycles and watch for a single long, low-intensity flash, to confirm pattern has been saved.

To set flasher to opposite phase (wig-wag), set flasher to desired pattern (see above), and connect blue striped wire to power supply. Flasher will flash exactly opposite of selected pattern.

Flash patterns

- | | |
|------------------------------|-------------------------|
| 1) Single Flash 75/min (KKK) | 10) Nova Flash 75/min |
| 2) Double Flash 75/min | 11) Power Flash 75/min |
| 3) Triple Flash 75/min | 12) Power Flash 150/min |
| 4) Quad Flash 75/min | 13) Dual Bright 75/min |
| 5) Single Flash 150/min | 14) Ramp Flash 75/min |
| 6) Double Flash 150/min | 15) Ramp Flash 150/min |
| 7) Triple Flash 150/min | 16) Action Ramp 75/150 |
| 8) Quad Flash 150/min | |
| 9) Active Flash 75/150 | |

	AutoSync	Steady On
Red	12 Volt Power	
Black	Ground	
Yellow (Night Mode)	Connect to 12V for low intensity night mode	Dual function wire; accepts 12V power or 12V low current signal
White	Connect momentarily to 12V for pattern change	
Blue/White Stripe	Connect to 12V power for alternate phase flash	

TecNiq Inc Lighting Displays



**Interior Lighting Display Kit
(P01-INT0-1)**



**Ambulance Lighting Display Kit
(P01-AMB0-1)**



**Emergency Vehicle Display Kit
(P01-EVM0-1)**



**DOT Lighting Display Kit
(P01-DOT0-1)**

Wires, Connectors, and Accessories

For full list of
part numbers
see pg 80



**Slide Dimmer
(E99-D002-1)**



**Rotary Dimmer
(E99-D001-1)**



**S35 Right Angle
2 Pole (spade)
(S99-0035-1)**

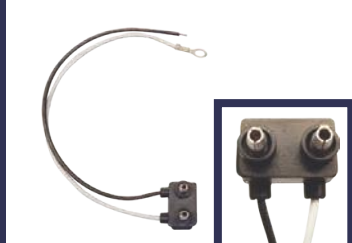

**.156" Bullet Right Angle
2 Pole
(S99-0010-1)**



**Straight Tri-pole
(T99-0010-1)**



**Right Angle Tri-pole
(T99-0020-1)**



**Straight
Amp Connection
(T99-0040-1)**



**Straight Amp/
Straight Tri-pole
(T99-0050-1)**

NFPA 1901 Exterior Warning Lighting Minimum Requirements

The warning lights have two separate operating modes with two corresponding specifications.

1. Calling for the right of way (Responding)
2. Blocking the right of way (At the Scene)
3. Flasher Color Specifications

Function	Red	Blue	Amber	White
RESPONDING	Any Zone		Any Zone except A	Any Zone except C
AT THE SCENE	Any Zone			Not Permitted

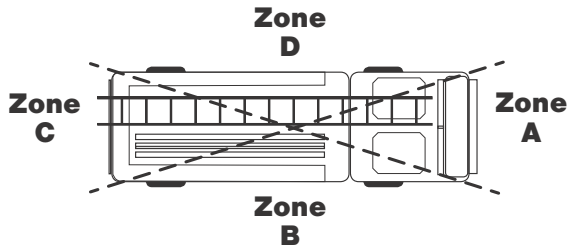

Small Apparatus - Less than 25'

Responding	Zone A	Zone B	Zone C	Zone D
	Upper & Lower Combined			
H	1,000,000	200,000	400,000	200,000
ANY H POINT	10,000	8,000	10,000	8,000
+/- 5° ANY H	3,500	3,500	3,500	3,500

At The Scene	Zone A	Zone B	Zone C	Zone D
	Upper & Lower Combined			
H	1,000,000	200,000	400,000	200,000
ANY H POINT	10,000	8,000	10,000	8,000
+/- 5° ANY H	3,500	3,500	3,500	3,500

NOTE: All values are in candela-seconds/minute.
H = Horizontal plane passing through the optical center

A small apparatus is categorized as a vehicle with a bumper to bumper length of less than twenty-five (25) feet. They have four (4) separate zones. The specifications for each zone include both upper and lower lights. Refer to the NFPA 1901 Standard for Automotive Fire Apparatus, Chapter 13 Low Voltage Electrical Systems and Warning Devices.

Large Apparatus - Greater than 25'

Responding	Zone A		Zone B		Zone C		Zone D	
	Upper	Lower	Upper	Lower	Upper	Lower	Upper	Lower
H	1,000,000	150,000	400,000	150,000	400,000	150,000	400,000	150,000
ANY H POINT	10,000	3,750	10,000	3,750	10,000	3,750	10,000	3,750
+/- 5° ANY H	3,500	1,300	3,500	1,300	3,500	1,300	3,500	1,300

At The Scene	Zone A		Zone B		Zone C		Zone D	
	Upper	Lower	Upper	Lower	Upper	Lower	Upper	Lower
H	400,000	150,000	400,000	150,000	800,000	150,000	400,000	150,000
ANY H POINT	10,000	3,750	10,000	3,750	10,000	3,750	10,000	3,750
+/- 5° ANY H	3,500	1,300	3,500	1,300	3,500	1,300	3,500	1,300

NOTE: All values are in candela-seconds/minute. H= Horizontal plane passing through the optical center

A large apparatus is categorized as a vehicle with a length of greater than twenty-five (25) feet. They are divided into four (4) separate zones, each divided into upper and lower.

For lower levels of Zones B & D, distances between optical warning devices may not exceed twenty five (25) feet. Additional mid-ship devices are required.

Basic Equipment Required on All Trucks, Buses, & MPVs

	DESCRIPTION				MANDATORY REQUIREMENTS		
	Equipment	(SAE Lens Coding)	Functional Purpose	QTY	Color	Location	Height (in.) From Ground
1	Headlamps - Lower Beam -US requires "DOT" lettering on lens -US & Canada require light source code on lens	(H, HR)	Forward road illumination	Min 2	White	On front - symmetrical - as far apart as practicable - 4 lamp system - outboard or above upper beams	22"- 54"
	Headlamps - Upper Beam -US requires "DOT" lettering on lens -US & Canada require light source code on lens	(H, HR)	Forward road illumination	Min 2	White	On front - symmetrical - 4 lamp system - inboard or below lower beams	22"- 54"
	Parking Lamps -Vehicles less than 80" wide	(P)	Indicate parked vehicle	Min 2	White/Amber	On the front - symmetrical - as far apart as practicable	15"- 72"
	Daytime Running Lamps -US - Optional - requires "DRL" lettering if not headlamp -Canada - Required	(Y2)	Indicate in use vehicle	Min 2	White/Amber		15" minimum *Max depends on type
	Front Turn Signal/ Hazard Warning Lamps	(I)	Indicates direction of turn/identify disabled vehicle	Min 2	Amber	On the front - symmetrical - as far apart as practicable	15"- 83"
2 Front Clearance Lamps -Vehicles 80" wide or wider	(P2, PC* or P3, PC2*)	Show vehicle's width	Min 2	Amber	At widest point - symmetrical - as far forward as practicable - facing forward	As high as practicable	
3 Front Identification Lamps (ID) -Vehicles 80" wide or wider	(P2 or P3)	Indicate presence of a wide vehicle	Exactly 3	Amber	On the front - center - horizontally spaced 6"- 12" apart	As high as practicable or on top of the cab	
4a Front Side Marker Lamps	(P2, PC* or P3, PC2*)	Indicate vehicle presence & length	Min 2	Amber	Each side at front - as far forward as practicable	15" minimum	
4b Front Side Reflex Reflectors	(A)		Min 2	Amber	Each side at front - as far forward as practicable facing sideward	15"- 60"	
5a Rear Side Marker Lamps	(P2, PC* or P3, PC2*)	Indicate vehicle presence & length	Min 2	Red	Each side at rear - as far back as practicable	15" minimum	
5b Rear Side Reflex Reflectors	(A)		Min 2	Red	Each side at rear - as far back as practicable facing sideward	15"- 60"	
6 Rear Clearance Lamps -Vehicles 80" wide or wider -Not required on truck tractors	(P2, PC* or P3, PC2*)	Show's veh. width- MAY NOT be combined with tail lamps	Min 2	Red	At widest point - symmetrical - on the rear or near the rear - facing Rearward	15" minimum	
7 Rear Identification Lamps -Vehicles 80" wide or wider -Not required on truck tractors	(P2 or P3)	Indicate Presence of Long Vehicle	Exactly 3	Red	On the rear - center, facing rearward - horizontally spaced 6"- 12" apart	15"- 60"	
8	Tail Lamps	(T)	Indicate vehicle's presence and width	Min 2	Red	On the rear - symmetrical as far apart as practicable	15"- 72"
	Stop Lamps	(S)	Indicate Braking	Min 2	Red		
	Rear Turn Signal/ Hazard Warning Lamps	(I)	Indicate direction of turn/ identify disabled vehicle	Min 2	Red/Amber		15"- 83"
	Rear Reflex Reflectors	(A)	Show vehicle's presence and width	Min 2	Red		15"- 60"
9 Backup Lamp	(R)	Illuminates ground behind the vehicle and alert road users	Min 1	White	Rear	No requirement	
10 License Plate Lamp(s)	(L)	Illuminates license plate	Min 1	White	On the rear - above or at the sides of license plate	No requirement	
11 Center High Mounted Stop Lamp	(U3)	Indicates Braking	Min 1	Red	On the rear - centerline of the vehicle	34" minimum	

*Photometrically certified at installation angle

Length - 30' or longer

	DESCRIPTION				MANDATORY REQUIREMENTS		
	Equipment	(SAE Lens Coding)	Functional Purpose	QTY	Color	Location	Height (in.) From Ground
12a	Intermediate Side Marker Lamps	(P2 or P3)	Indicate presence of long vehicle	Min 2	Amber	Each side near center	15" minimum
12b	Intermediate Side Reflex Reflectors	(A)	Indicate presence of long vehicle	Min 2	Amber	Each side near center - Facing Sideward	15"- 60"

Truck Tractors

	DESCRIPTION				MANDATORY REQUIREMENTS		
	Conspicuity Treatment	DOT Coding	QTY	Color	Location	Height (in.) From Ground	Options
9	Rear Upper Body Marking	DOT-C, DOT-C2, DOT-C3, DOT-C4	Exactly 2 pairs of 300mm (11.8") long strips	White	On the rear upper corners of cab - facing rearward	At the top	Rear lower body and side conspicuity treatment may also be solid white, solid amber, or white and amber.
11	Rear Marking		Exactly 2 sections of min 600mm (24") long strips	Red/White	Rear - facing rearward - on fenders, on mud flap brackets, or within 300mm below top of mudflaps	As horizontal and as close to the range of 15"- 60" from ground as practicable	

Truck, Bus, & MPV Requirements

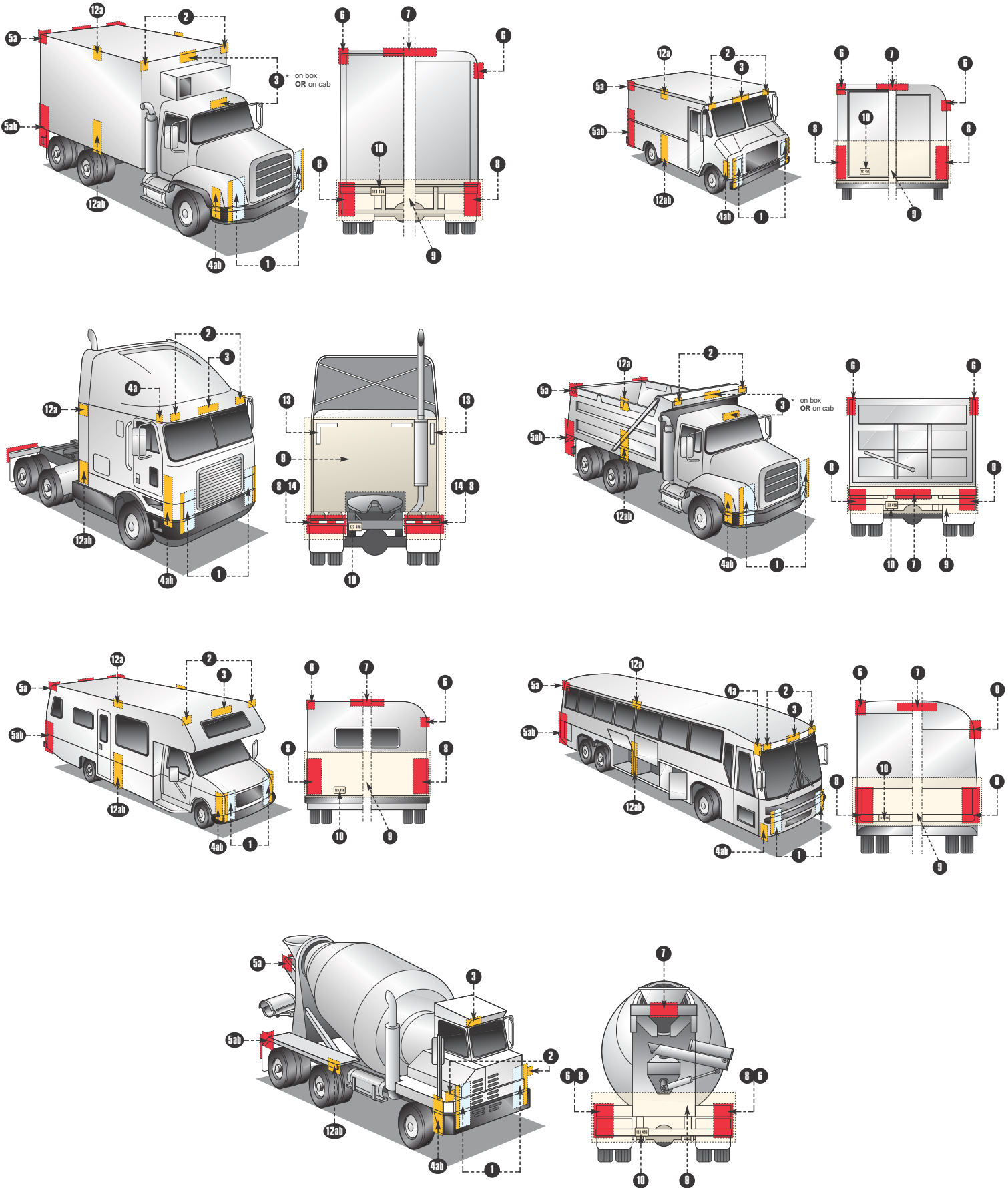

Basic Equipment Required on All Trailers

	DESCRIPTION				MANDATORY REQUIREMENTS		
	Equipment	(SAE Lens Coding)	Functional Purpose	QTY	Color	Location	Height (in.) From Ground
1	Tail Lamps	(T)	Indicate vehicle presence & width	Min 2	Red	On the rear - symmetrical - as far apart as practicable	15"- 72"
	Stop Lamps	(S)	Indicate braking	Min 2	Red		15"- 72"
	Rear Turn Signal Lamps	(I)	Indicate direction of turn	Min 2	Red/ Amber		15"- 83"
	Rear Reflex Reflectors	(A)	Indicate vehicle presence & width	Min 2	Red		15"- 60"
2	License Plate Lamps	(L)	Illuminate license plate	Min 1	White	On the rear - above or at the sides of license plate	No requirement
3	Rear Side Marker Lamps	(P2, PC* or P3, PC2*)	Indicate vehicle presence & length	Min 2	Red	Each side at rear - as far back as practicable	15"- 60" (no max. for vehicles under 80" wide)
	Rear Side Reflex Reflectors	(A)		Min 2	Red	Each side at rear - as far back as practicable facing sideward	15"- 60"
4a	Front Side Marker Lamps	(P2, PC* or P3, PC2*)	Indicate vehicle presence & length	Min 2	Amber	Each side at front - as far forward as practicable	15" minimum
4b	Front Side Reflex Reflectors	(A)		Min 2	Amber	Each side at front - as far forward as practicable facing sideward	15"- 60"

*Photometrically certified at installation angle

Length - 30' or longer

	DESCRIPTION				MANDATORY REQUIREMENTS		
	Equipment	(SAE Lens Coding)	Functional Purpose	QTY	Color	Location	Height (in.) From Ground
5a	Intermediate Side Marker Lamps	(P2 or P3)	Indicate presence of long vehicle	Min 2	Amber	Each side near center - Facing Sideward	15" minimum
5b	Intermediate Side Reflex Reflectors	(A)	Indicate presence of long vehicle	Min 2	Amber		15"- 60"

Width - 80" or wider

	DESCRIPTION				MANDATORY REQUIREMENTS		
	Equipment	(SAE Lens Coding)	Functional Purpose	QTY	Color	Location	Height (in.) From Ground
6	Rear Clearance Lamps	(P2, PC* or P3, PC2*)	Shows veh. width- MAY NOT be combined with tail lamps	Min 2	Red	At widest point - symmetrical - on or near the rear - facing Rearward	15" minimum
7	Rear Identification Lamps	(P2 or P3)	Indicate Presence of Long Vehicle	Exactly 3	Red	On the rear - center, facing rearward - horizontally spaced 6"- 12" apart	15"- 60"
8	Front Clearance Lamps	(P2, PC* or P3, PC2*)	Show Vehicle's Width	Min 2	Amber	At widest point - symmetrical - as far forward as practicable - facing forward	As high as practicable

*Photometrically certified at installation angle

Width - 80" or wider AND GVWR of 10,000 lbs or MORE







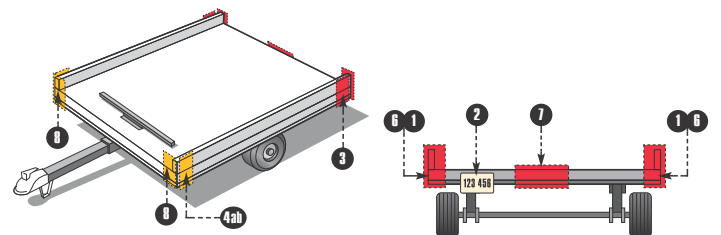
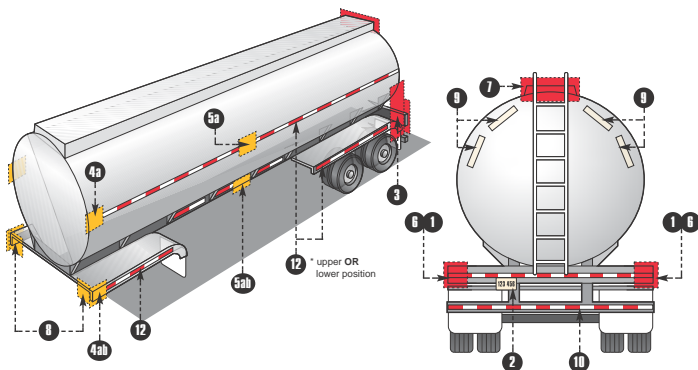
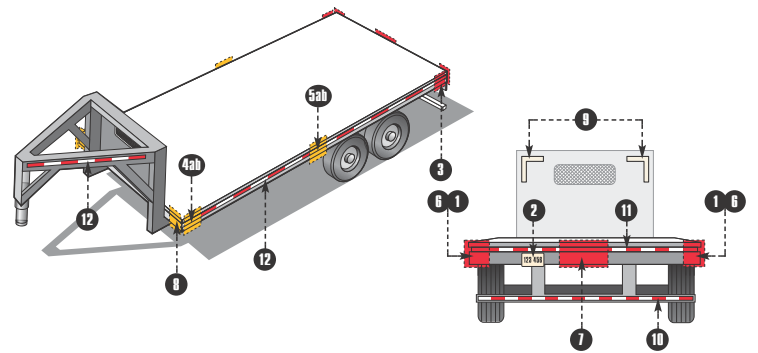
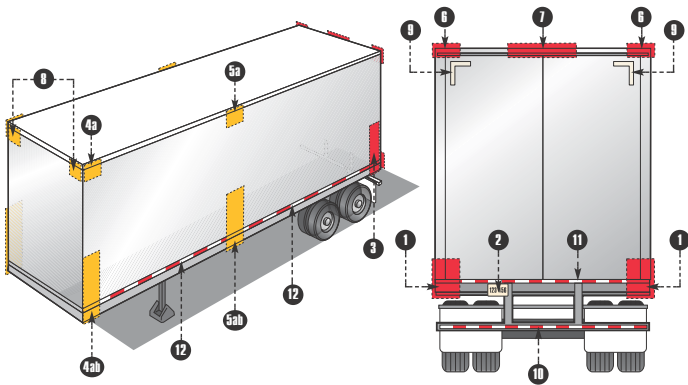
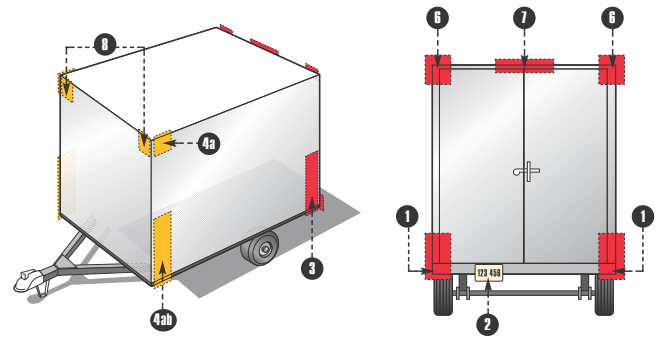
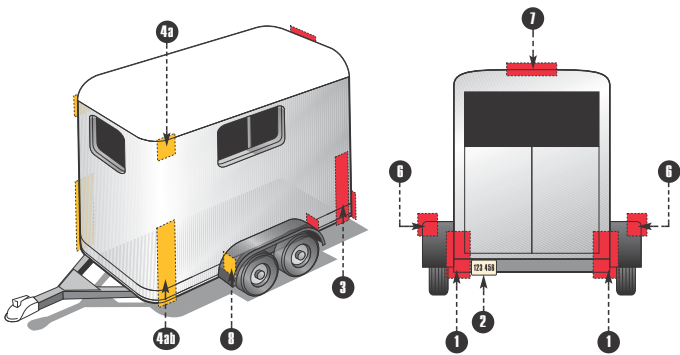
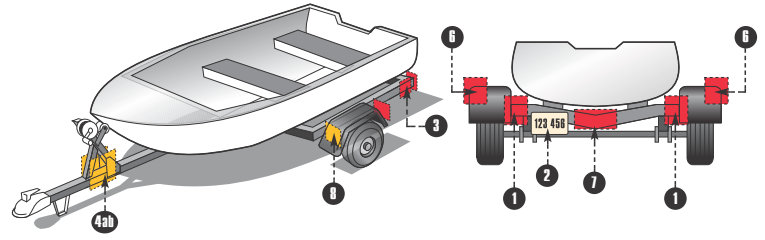
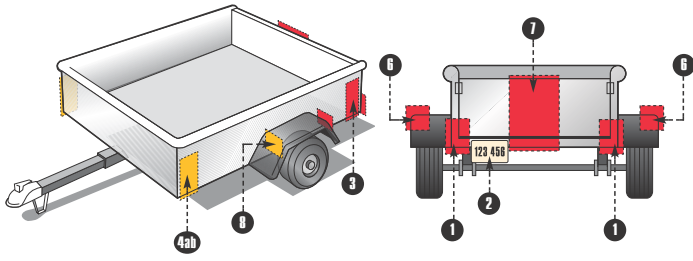



	DESCRIPTION			MANDATORY REQUIREMENTS			
	Conspicuity Treatment	DOT Coding	QTY	Color	Location	Height (in.) From Ground	Options
9	Rear Upper Body Marking	DOT-C, DOT-C2, DOT-C3, DOT-C4	Exactly 2 pairs of 300mm (11.8") long strips	White	On the rear upper corners - facing rearward	At the top	Rear lower body and side conspicuity treatment may also be solid white, solid amber, or white and amber.
10	Bumper Bar Marking		Continuous	Red/White	On the rear bumper bar's horizontal element - full width - facing rearward	No requirement	
11	Rear Lower Body Marking		Continuous	Red/White (see options)	On the rear - full width of the vehicle - facing rearward	As horizontal and as close to the range of 15"- 60" from ground as practicable	
12	Side Marking		see location	Red/White (see options)	Each side - facing sideward - continuous, or evenly spaced over minimum of 50% of length, starts and ends as close to the front and rear of vehicle as practicable		

- Reflex reflectors may not be required if they are replaced, in their required location, with conspicuity treatment (Optional in Canada).

































Trailer Requirements



D02 - Ladder Lights**Pg 28**































































D02-A001-1	Ladder Light Amber 1 Section - 14" Section Length	 	Made to Order
D02-B001-1	Ladder Light Blue 1 Sections - 14" Section Length	 	Made to Order
D02-G001-1	Ladder Light Green 1 Section - 14" Section Length	 	Made to Order
D02-R001-1	Ladder Light Red 1 Section - 14" Section Length	 	Made to Order
D02-W001-1	Ladder Light White 1 Section - 14" Section Length	 	Made to Order





















D04 - Dragon Light - Linear Series**Pg 31**

D04-0BH0-1	Dragon Light Linear Horizontal Case - Black		50	-
D04-0BV0-1	Dragon Light Linear Vertical Case - Black		50	-
D04-0SH0-1	Dragon Light Linear Horizontal Case - SS		50	-
D04-0SV0-1	Dragon Light Linear Vertical Case - SS		50	-
D04-0WH0-1	Dragon Light Linear Horizontal Case - White		50	-
D04-0WV0-1	Dragon Light Linear Vertical Case - White		50	-
D04-A000-1	Dragon Light Linear Body Amber - 9" Wire	 	50	Pigtail (9")
D04-A001-1	Dragon Light Linear Body Amber - 36" Wire	 	50	Pigtail (36")
D04-B000-1	Dragon Light Linear Body Blue - 9" Wire	 	50	Pigtail (9")
D04-B001-1	Dragon Light Linear Body Blue - 36" Wire	 	50	Pigtail (36")
D04-D000-1	Dragon Light Linear Body Deep Red - 9" Wire	 	50	Pigtail (9")
D04-D001-1	Dragon Light Linear Body Deep Red - 36" Wire	 	50	Pigtail (36")
D04-G000-1	Dragon Light Linear Body Green - 9" Wire	 	50	Pigtail (9")
D04-G001-1	Dragon Light Linear Body Green - 36" Wire	 	50	Pigtail (36")
D04-J001-1	Dragon Light Linear Body Jade - 36" Wire	 	50	Pigtail (9")
D04-N001-1	Dragon Light Linear Body Orange - 36" Wire	 	50	Pigtail (36")
D04-R000-1	Dragon Light Linear Body Red - 9" Wire	 	50	Pigtail (9")
D04-R001-1	Dragon Light Linear Body Red - 36" Wire	 	50	Pigtail (36")
D04-U001-1	Dragon Light Linear Body Ultraviolet - 36" Wire	 	50	Pigtail (36")
D04-W000-1	Dragon Light Linear Body White - 9" Wire	 	50	Pigtail (9")
D04-W001-1	Dragon Light Linear Body White - 36" Wire	 	50	Pigtail (36")
D04-W00F-1	Dragon Light Linear Body White Flood - 9" Wire	 	50	Pigtail (9")

D14 - Dragon Light - Oval Series**Pg 31**

D14-0B00-1	Dragon Light Oval Case - Black		50	-
D14-0S00-1	Dragon Light Oval Case - SS		50	-
D14-0W00-1	Dragon Light Oval Case - White		50	-
D14-A000-1	Dragon Light Oval Body Amber - 9" Wire	 	50	Pigtail (9")
D14-A001-1	Dragon Light Oval Body Amber - 36" Wire	 	50	Pigtail (36")
D14-B000-1	Dragon Light Oval Body Blue - 9" Wire	 	50	Pigtail (9")
D14-B001-1	Dragon Light Oval Body Blue - 36" Wire	 	50	Pigtail (36")
D14-D000-1	Dragon Light Oval Body Deep Red - 9" Wire	 	50	Pigtail (9")
D14-D001-1	Dragon Light Oval Body Deep Red - 36" Wire	 	50	Pigtail (36")
D14-G000-1	Dragon Light Oval Body Green - 9" Wire	 	50	Pigtail (9")
D14-G001-1	Dragon Light Oval Body Green - 36" Wire	 	50	Pigtail (36")



Part No.	Part Description	Color	STD Pack	Connector
D14-J001-1	Dragon Light Oval Body Jade - 36" Wire	 	50	Pigtail (36")
D14-N001-1	Dragon Light Oval Body Orange - 36" Wire	 	50	Pigtail (36")
D14-R000-1	Dragon Light Oval Body Red - 9" Wire	 	50	Pigtail (9")
D14-R001-1	Dragon Light Oval Body Red - 36" Wire	 	50	Pigtail (36")
D14-U000-1	Dragon Light Oval Body Ultraviolet - 9" Wire	 	50	Pigtail (9")
D14-U001-1	Dragon Light Oval Body Ultraviolet - 36" Wire	 	50	Pigtail (36")
D14-W000-1	Dragon Light Oval Body White - 9" Wire	 	50	Pigtail (9")
D14-W001-1	Dragon Light Oval Body White - 36" Wire	 	50	Pigtail (36")
D14-W00F-1	Dragon Light Oval Body White Flood - 9" Wire	 	50	Pigtail (9")
D21 - Link Lights				Pg 27
D21-AC00-1	Emergency Accessory Light, Amber LED	 	50	Pigtail (4.5")
D21-BC00-1	Emergency Accessory Light, Blue LED	 	50	Pigtail (4.5")
D21-GC00-1	Emergency Accessory Light, Green LED	 	50	Pigtail (4.5")
D21-RC00-1	Emergency Accessory Light, Red LED	 	50	Pigtail (4.5")
D21-WC00-1	Emergency Accessory Light, White LED	 	50	Pigtail (4.5")
E03 - Eon Series Light				Pg 30
E03-000G-1	Eon Light Linear Vertical Case Gasket		50	-
E03-00HG-1	Eon Light Linear Horizontal Case Gasket		50	-
E03-0BH0-1	Eon Light Linear Horizontal Case - Black		50	-
E03-0BV0-1	Eon Light Linear Vertical Case - Black		50	-
E03-0SH0-1	Eon Light Linear Horizontal Case - SS		50	-
E03-0SV0-1	Eon Light Linear Vertical Case - SS		50	-
E03-A001-1	Eon Light Linear Body Amber - 36" Wire	 	50	Pigtail (36")
E03-A003-1	Eon Light Linear Body Amber Dual Intensity - 9" Wire	 	50	Pigtail (9")
E03-B001-1	Eon Light Linear Body Blue - 36" Wire	 	50	Pigtail (36")
E03-D001-1	Eon Light Linear Body Deep Red - 36" Wire	 	50	Pigtail (36")
E03-D003-1	Eon Light Linear Body Deep Red Dual Intensity - 9" Wire	 	50	Pigtail (9")
E03-G001-1	Eon Light Linear Body Green - 36" Wire	 	50	Pigtail (36")
E03-J001-1	Eon Light Linear Body Jade - 36" Wire	 	50	Pigtail (36")
E03-L000-1	Eon Light Linear Body Neutral White - 9" Wire	 	50	Pigtail (9")
E03-M000-1	Eon Light Linear Body Warm White - 9" Wire	 	50	Pigtail (9")
E03-N001-1	Eon Light Linear Body Orange - 36" Wire	 	50	Pigtail (36")
E03-RGB1-1	Eon Light Linear Body RGB - 82" Wire	 	50	Sheathed Pigtail (82")
E03-W000-1	Eon Light Linear Body Cool White - 9" Wire	 	50	Pigtail (9")
E03-W001-1	Eon Light Linear Body Cool White - 36" Wire	 	50	Pigtail (36")
E03-W00F-1	Eon Light Linear Body Cool White - Flood Lens - 9" Wire	 	50	Pigtail (9")
E05 - Interior Area Light				Pg 43
E05-WBS0-1	Interior Area Light, Surface Mt.,White LED, Black Cover	 	10	Sheathed Pigtail (6")
E05-WSS0-1	Interior Area Light, Surface Mt.,White LED, SS Cover	 	10	Sheathed Pigtail (6")
E05-WWS0-1	Interior Area Light, Surface Mt.,White LED, White Cover	 	10	Sheathed Pigtail (6")

Part No.	Part Description	Color	STD Pack	Connector
E05-0B00-1	Interior Area Light - 1" Round Bar Mt. Adapter		10	Sheathed Pigtail (6")
E06 - Silho-X 4" Series				Pg 34
E06-LS00-1	Silho-X 4" Round Neutral White Light SS Trim Ring	 	10	Pigtail (9")
E06-LS0R-1	Silho-X 4" Round Neutral White/Red Light SS Trim Ring	 	10	Pigtail (9")
E06-LSB0-1	Silho-X 4" Round Neutral White/Blue Combo Light SS Trim Ring	 	10	Pigtail (9")
E06-MS00-1	Silho-X 4" Round Warm White Light SS Trim Ring	 	10	Pigtail (9")
E06-MS0F-1	Silho-X 4" Round Warm White Light Diffuse Lens SS Trim Ring	 	10	Pigtail (9")
E06-MS0R-1	Silho-X 4" Round Warm White/Red Combo Lt SS Trim Ring	 	10	Pigtail (9")
E06-RS00-1	Silho-X 4" Round Red Light SS Trim Ring	 	10	Pigtail (9")
E06-WB00-1	Silho-X 4" Round Cool White Light Black Powder Coat Trim Ring	 	10	Pigtail (9")
E06-WS00-1	Silho-X 4" Round Cool White Light SS Trim Ring	 	10	Pigtail (9")
E06-WS0B-1	Silho-X 4" Round Cool White/Blue Combo Light SS Trim Ring	 	10	Pigtail (9")
E06-WS0F-1	Silho-X 4" Round Cool White Light Diffuse Lens SS Trim Ring	 	10	Pigtail (9")
E06-WS0R-1	Silho-X 4" Round Cool White/Red Combo Light SS Trim Ring	 	10	Pigtail (9")
E06-WSRF-1	Silho-X 4" Round Cool White/Red Combo Lt Diffuse Lens SS Trim Ring	 	10	Pigtail (9")
E07 - Emergency Vehicle Interior Light				Pg 41
E07-WC00-1	8" EV Recessed Cool White LED w/ Chrome Trim Ring	 	10	Pigtail (9")
E07-WW00-1	8" EV Recessed Cool White LED w/ White Powder Coat Trim Ring	 	10	Pigtail (9")
E08 - Emergency Vehicle Interior Light				Pg 41
E08-LC00-1	8" EV Neutral White Interior Light Chrome Trim - 31 LEDs	 	10	Pigtail (9")
E08-LC10-1	8" EV Neutral White Interior Light Chrome Trim - 18 LEDs	 	10	Pigtail (9")
E08-LC20-1	8" EV White Interior Light Chrome Trim - 18 LED's MRI	 	10	Pigtail (9")
E08-LCR0-1	8" EV Neutral White/Red Interior Light Chrome Trim - 18/12 LED	 	10	Pigtail (9")
E08-LW00-1	8" EV Neutral White Interior Light White Trim - 31 LEDs	 	10	Pigtail (9")
E08-LW10-1	8" EV Neutral White Interior Light White Trim - 18 LEDs	 	10	Pigtail (9")
E08-LWR0-1	8" EV Neutral White/Red Interior Light White Trim - 18/12 LED	 	10	Pigtail (9")
E08-WC00-1	8" EV Cool White Interior Light Chrome Trim - 31 LEDs	 	10	Pigtail (9")
E08-WC10-1	8" EV Cool White Interior Light Chrome Trim - 18 LEDs	 	10	Pigtail (9")
E08-WCR0-1	8" EV Cool White/Red Interior Light Chrome Trim - 18/12 LED	 	10	Pigtail (9")
E08-WW00-1	8" EV Cool White Interior Light White Trim - 31 LEDs	 	10	Pigtail (9")
E08-WW10-1	8" EV Cool White Interior Light White Trim - 18 LEDs	 	10	Pigtail (9")
E08-WW20-1	8" EV Cool White Interior Light White Trim - 18 LED's MRI	 	10	Pigtail (9")
E08-WWR0-1	8" EV Cool White/Red Interior Light White Trim - 18/12 LED	 	10	Pigtail (9")
E10 - Ground/Pump Panel Light				Pg 45
E10-W000-1	EV Ground/Pump Panel Light	 	10	Sheathed Pigtail
E10-WS00-1	EV Ground/Pump Panel Light with SS Bracket	 	10	Sheathed Pigtail
E11 - Silho-X 1.5" Series				Pg 34
E11-AS01-1	Silho-X 1.5" Round Amber Light - SS Trim Ring - 36" Wire	 	10	Pigtail (36")
E11-BS01-1	Silho-X 1.5" Round Blue Light - SS Trim Ring - 36" Wire	 	10	Pigtail (36")
E11-DS01-1	Silho-X 1.5" Round Deep Red Light - SS Trim Ring - 36" Wire	 	10	Pigtail (36")

Part No.	Part Description	Color	STD Pack	Connector
E11-GS01-1	Silho-X 1.5" Round Green Light - SS Trim Ring - 36" Wire	 	10	Pigtail (36")
E11-JS01-1	Silho-X 1.5" Round Jade Light - SS Trim Ring - 36" Wire	 	10	Pigtail (36")
E11-LS00-1	Silho-X 1.5" Round Neutral White light - SS Trim Ring	 	10	Pigtail (9")
E11-MS00-1	Silho-X 1.5" Round Warm White Light - SS Trim Ring	 	10	Pigtail (9")
E11-MS0F-1	Silho-X 1.5" Round Warm White Light Diffuse Lens - SS Trim Ring	 	10	Pigtail (9")
E11-NS01-1	Silho-X 1.5" Round Orange Light - SS Trim Ring - 36" Wire	 	10	Pigtail (36")
E11-RS00-1	Silho-X 1.5" Round Red Light - SS Trim Ring	 	10	Pigtail (9")
E11-WS00-1	Silho-X 1.5" Round Cool White Light - SS Trim Ring	 	10	Pigtail (9")
E11-WS01-1	Silho-X 1.5" Round Cool White Light - SS Trim Ring - 36" Wire	 	10	Pigtail (36")
E11-WS0F-1	Silho-X 1.5" Round Cool White Light Diffuse Lens - SS Trim Ring	 	10	Pigtail (9")

E13 - Silho-X 2.75" Series

Pg 34-35





































































E13-AB10-1	Silho-X 2.75" Round LP Amber Light - Black Trim Ring	 	20	Pigtail (9")
E13-AW10-1	Silho-X 2.75" Round LP Amber Light - White Trim Ring	 	20	Pigtail (9")
E13-BB10-1	Silho-X 2.75" Round LP Blue Light - Black Trim Ring	 	20	Pigtail (9")
E13-BW10-1	Silho-X 2.75" Round LP Blue Light - White Trim Ring	 	20	Pigtail (9")
E13-GB10-1	Silho-X 2.75" Round LP Green Light - Black Trim Ring	 	20	Pigtail (9")
E13-GW10-1	Silho-X 2.75" Round LP Green Light - White Trim Ring	 	20	Pigtail (9")
E13-LS00-1	Silho-X 2.75" Round Neutral White Light - SS Trim Ring	 	20	Pigtail (9")
E13-LS0R-1	Silho-X 2.75" Round Neutral White/Red Light - SS Trim Ring	 	20	Pigtail (9")
E13-MS00-1	Silho-X 2.75" Round Warm White Light - SS Trim Ring	 	20	Pigtail (9")
E13-MS0F-1	Silho-X 2.75" Round Warm White Light Diffuse Ln - SS Trim Ring	 	20	Pigtail (9")
E13-MS0R-1	Silho-X 2.75" Round Warm White/Red Combo Light - SS Trim Ring	 	20	Pigtail (9")
E13-RB10-1	Silho-X 2.75" Round LP Red Light - Black Trim Ring	 	20	Pigtail (9")
E13-RS00-1	Silho-X 2.75" Round Red Light SS Trim Ring	 	20	Pigtail (9")
E13-RW10-1	Silho-X 2.75" Round LP Red Light - White Trim Ring	 	20	Pigtail (9")
E13-WB10-1	Silho-X 2.75" Round Cool White Light - Black Trim Ring	 	20	Pigtail (9")
E13-WS00-1	Silho-X 2.75" Round Cool White Light - SS Trim Ring	 	20	Pigtail (9")
E13-WS0F-1	Silho-X 2.75" Round Cool White Light Diffuse Lens - SS Trim Ring	 	20	Pigtail (9")
E13-WS0R-1	Silho-X 2.75" Round Cool White/Red Combo Light - SS Trim Ring	 	20	Pigtail (9")
E13-WW10-1	Silho-X 2.75" Round LP Cool White Light - White Trim Ring	 	20	Pigtail (9")









































E16 - High Output Dome Light

Pg 42

E16-LW00-1	E16 Interior SM Neutral White Oval Light White Base	 	20	Sheathed Pigtail
E16-LWS0-1	E16 Interior SM Neutral White Oval Light White Base w/Switch	 	20	Sheathed Pigtail
E16-LB00-1	E16 Interior SM Neutral White Oval Light Black Base	 	20	Sheathed Pigtail
E16-LBS0-1	E16 Interior SM Neutral White Oval Light Black Base w/Switch	 	20	Sheathed Pigtail
E16-MW00-1	E16 Interior SM Warm White Oval Light White Base	 	20	Sheathed Pigtail
E16-MWS0-1	E16 Interior SM Warm White Oval Light White Base w/Switch	 	20	Sheathed Pigtail
E16-MB00-1	E16 Interior SM Warm White Oval Light Black Base	 	20	Sheathed Pigtail
E16-MBS0-1	E16 Interior SM Warm White Oval Light Black Base w/Switch	 	20	Sheathed Pigtail
E16-WW00-1	E16 Interior SM Cool White Oval Light White Base	 	20	Sheathed Pigtail







Part No.	Part Description	Color	STD Pack	Connector
E16-WWS0-1	E16 Interior SM Cool White Oval Light White Base w/Switch		20	Sheathed Pigtail
E16-WB00-1	E16 Interior SM Cool White Oval Light Black Base		20	Sheathed Pigtail
E16-WBS0-1	E16 Interior SM Cool White Oval Light Black Base w/Switch		20	Sheathed Pigtail
E18 - 4.5" Utility Light				Pg 42
E18-LC00-1	Surface mount 4.5"x2.5" Neutral White 12 LED Dome light		10	Sheathed Pigtail
E18-LCS0-1	Surface mount 4.5"x2.5" Neutral White 12 LED Dome light w/ Switch		10	Sheathed Pigtail
E18-WC00-1	Surface mount 4.5"x2.5" Cool White 12 LED Dome light		10	Sheathed Pigtail
E18-WCS0-1	Surface mount 4.5"x2.5" Cool White 12 LED Dome light w/ Switch		10	Sheathed Pigtail
E20 - Orion Series Surface Mount Dome Light				Pg 34
E20-LA00-1	6" Interior Light Neutral White - Satin Trim Ring		5	Pigtail (15")
E20-LA0R-1	6" Interior Light Neutral White/Red - Satin Trim Ring		5	Pigtail (15")
E20-LC00-1	6" Interior Light Neutral White - Chrome Trim Ring		5	Pigtail (15")
E20-LC0R-1	6" Interior Light Neutral White/Red - Chrome Trim Ring		5	Pigtail (15")
E20-MA00-1	6" Interior Light Warm White - Satin Trim Ring		5	Pigtail (15")
E20-MA03-1	6" Interior Light Warm White Tri-Level Intensity - Satin Trim Ring		5	Pigtail (15")
E20-MA0R-1	6" Interior Light Warm White/Red Combo - Satin Trim Ring		5	Pigtail (15")
E20-MC00-1	6" Interior Light Warm White - Chrome Trim Ring		5	Pigtail (15")
E20-WC00-1	6" Interior Light Cool White - Chrome Trim Ring		5	Pigtail (15")
E20-WC0R-1	6" Interior Light Cool White/Red Combo - Chrome Trim Ring		5	Pigtail (15")
E20-WCB0-1	6" Interior Light Cool White/Blue Combo - Chrome Trim Ring		5	Pigtail (15")
E25 - 3" Spring Mounted Dome Light				Pg 36
E25-L000-1	3" Spring Mounted Dome Light, Neutral White		10	Sheathed Pigtail
E25-L0S0-1	3" Spring Mounted Dome Light, Neutral White, w/Switch		10	Sheathed Pigtail
E25-M000-1	3" Spring Mounted Dome Light, Warm White		10	Sheathed Pigtail
E25-M0S0-1	3" Spring Mounted Dome Light, Warm White, w/Switch		10	Sheathed Pigtail
E25-W000-1	3" Spring Mounted Dome Light, Cool White		10	Sheathed Pigtail
E25-W0S0-1	3" Spring Mounted Dome Light, Cool White, w/Switch		10	Sheathed Pigtail
E26 - 4.5" Spring Mounted Dome Light				Pg 36
E26-L000-1	4.5" Spring Mounted Dome Light, Neutral White		10	Sheathed Pigtail
E26-L0S0-1	4.5" Spring Mounted Dome Light, Neutral White, w/Switch		10	Sheathed Pigtail
E26-LP00-1	4.5" Spring Mounted Premium Dome Light, Neutral White		10	Sheathed Pigtail
E26-LPS0-1	4.5" Spring Mounted Premium Dome Light, Neutral White, w/Switch		10	Sheathed Pigtail
E26-M000-1	4.5" Spring Mounted Dome Light, Warm White		10	Sheathed Pigtail
E26-M0S0-1	4.5" Spring Mounted Dome Light, Warm White, w/Switch		10	Sheathed Pigtail
E26-MP00-1	4.5" Spring Mounted Premium Dome Light, Warm White		10	Sheathed Pigtail
E26-MPS0-1	4.5" Spring Mounted Premium Dome Light, Warm White, w/Switch		10	Sheathed Pigtail
E26-W000-1	4.5" Spring Mounted Dome Light, Cool White		10	Sheathed Pigtail
E26-W0S0-1	4.5" Spring Mounted Dome Light, Cool White, w/Switch		10	Sheathed Pigtail
E26-WP00-1	4.5" Spring Mounted Premium Dome Light, Cool White		10	Sheathed Pigtail

Part No.	Part Description	Color	STD Pack	Connector
E26-WPS0-1	4.5" Spring Mounted Premium Dome Light, Cool White, w/Switch	 	10	Sheathed Pigtail
E27 - 3" Surface Mounted Dome Light				Pg 37
E27-L000-1	3" Surface Mounted Dome Light, Neutral White	 	10	Sheathed Pigtail
E27-M000-1	3" Surface Mounted Dome Light, Warm White	 	10	Sheathed Pigtail
E27-W000-1	3" Surface Mounted Dome Light, Cool White	 	10	Sheathed Pigtail
E28 - 4.5" Surface Mounted Dome Light				Pg 37
E28-L000-1	4.5" Surface Mounted Dome Light, Neutral White	 	10	Sheathed Pigtail
E28-LOS0-1	4.5" Surface Mounted Dome Light, Neutral White, w/Switch	 	10	Sheathed Pigtail
E28-LP00-1	4.5" Surface Mounted Premium Dome Light, Neutral White	 	10	Sheathed Pigtail
E28-LPS0-1	4.5" Surface Mounted Premium Dome Light, Neutral White, w/Switch	 	10	Sheathed Pigtail
E28-LPW00-1	4.5" Surface Mounted Premium Dome Light, Neutral White White Trim	 	10	Sheathed Pigtail
E28-M000-1	4.5" Surface Mounted Dome Light, Warm White	 	10	Sheathed Pigtail
E28-M0S0-1	4.5" Surface Mounted Dome Light, Warm White, w/Switch	 	10	Sheathed Pigtail
E28-MP00-1	4.5" Surface Mounted Premium Dome Light, Warm White	 	10	Sheathed Pigtail
E28-MPS0-1	4.5" Surface Mounted Premium Dome Light, Warm White, w/Switch	 	10	Sheathed Pigtail
E28-W000-1	4.5" Surface Mounted Dome Light, Cool White	 	10	Sheathed Pigtail
E28-W0S0-1	4.5" Surface Mounted Dome Light, Cool White, w/Switch	 	10	Sheathed Pigtail
E28-WP00-1	4.5" Surface Mounted Premium Dome Light, Cool White	 	10	Sheathed Pigtail
E28-WPS0-1	4.5" Surface Mounted Premium Dome Light, Cool White, w/Switch	 	10	Sheathed Pigtail
E30 - High Performance Recessed Ceiling Light				Pg 38
E30-L000-1	Recessed 4K White 42 LED Light 6"x17.5"	 	12	Pigtail (12")
E30-L00M-1	Recessed 4K White 42 LED Light 6"x17.5" w/Motion Detection	 	12	Pigtail (12")
E30-L00R-1	Recessed 4K White/Red 42/16 LED Light 6"x17.5"	 	12	Pigtail (12")
E30-L010-1	Recessed 4K White 21 LED Light 6"x17.5"	 	12	Pigtail (12")
E30-L01R-1	Recessed 4K White/Red 21/16 LED Light 6"x17.5"	 	12	Pigtail (12")
E30-L0S0-1	Recessed 4K White 42 LED Light 6"x17.5" Switched	 	12	Pigtail (12")
E30-L0SR-1	Recessed 4K White/Red 42/16 LED Light 6"x17.5" Switched	 	12	Pigtail (12")
E30-L1S0-1	Recessed 4K White 21 LED Light 6"x17.5" Switched	 	12	Pigtail (12")
E30-L1SR-1	Recessed 4K White/Red 21/16 LED Light 6"x17.5" Switched	 	12	Pigtail (12")
E31 - High Performance Recessed Ceiling Light				Pg 39
E31-L0MB-1	Recessed 4K White 32 LED Light 6"x17.5" w/Motion Detection .180 Bullet	 	12	Pigtail (12")
E31-L00B-1	Recessed 4K White 32 LED Light 6"x17.5" .180 Bullet Connectors	 	12	Pigtail (12")
E34 - 3/4" Grommet Mount Step Accent Lights				Pg 35
E34-BB00-1	E34 Step Light Grommet Mounted Blue W/ Black Cover	 	100	Sheathed Pigtail
E34-BC00-1	E34 Step Light Grommet Mounted Blue W/ Chrome Cover	 	100	Sheathed Pigtail
E34-RB00-1	E34 Step Light Grommet Mounted Red W/ Black Cover	 	100	Sheathed Pigtail
E34-RC00-1	E34 Step Light Grommet Mounted Red W/ Chrome Cover	 	100	Sheathed Pigtail
E34-WB00-1	E34 Step Light Grommet Mounted White W/ Black Cover	 	100	Sheathed Pigtail
E34-WC00-1	E34 Step Light Grommet Mounted White W/ Chrome Cover	 	100	Sheathed Pigtail
E35/E36/E38 - Linear Area Light				Pg 40

Part No.	Part Description	Color	STD Pack	Connector
E35-LB00-1	Linear LED SM Light Neutral White Black Body 9W	 	10	Sheathed Pigtail
E35-LB0S-1	Linear LED SM Light Neutral White Black Body w/ Switch	 	10	Sheathed Pigtail
E35-MB00-1	Linear LED SM Light Warm White Black Body 9W	 	10	Sheathed Pigtail
E35-WB00-1	Linear LED SM Light Cool White Black Body 9W	 	10	Sheathed Pigtail
E35-WB0S-1	Linear LED SM Light Cool White Black Body 9W w/Switch	 	10	Sheathed Pigtail
E35-WB24-1	Linear LED SM Light Cool White Black Body 9W 24V	 	10	Sheathed Pigtail
E36-LB00-1	Linear LED SM Light Neutral White Black Body 18W	 	10	Sheathed Pigtail
E36-LB0S-1	Linear LED SM Light Neutral White Black Body 18W w/ Switch	 	10	Sheathed Pigtail
E36-LB24-1	Linear LED SM Light Neutral White Black Body 18W 24V	 	10	Sheathed Pigtail
E36-MB00-1	Linear LED SM Light Warm White Black Body 18W	 	10	Sheathed Pigtail
E36-WB00-1	Linear LED SM Light Cool White Black Body 18W	 	10	Sheathed Pigtail
E36-WB0S-1	Linear LED SM Light Cool White Black Body 18W w/Switch	 	10	Sheathed Pigtail
E36-WB24-1	Linear LED SM Cool Light White Black Body 18W 24V	 	10	Sheathed Pigtail
E38-LB00-1	Linear LED SM Light Neutral White Black Body 36W	 	10	Sheathed Pigtail
E38-LB0S-1	Linear LED SM Light Neutral White Black Body 36W w/ Switch	 	10	Sheathed Pigtail
E38-LB24-1	Linear LED SM Light Neutral White Black Body 36W 24V	 	10	Sheathed Pigtail
E38-MB00-1	Linear LED SM Light Warm White Black Body 36W	 	10	Sheathed Pigtail
E38-WB00-1	Linear LED SM Light Cool White Black Body 36W	 	10	Sheathed Pigtail
E38-WB0S-1	Linear LED SM Light Cool White Black Body 36W w/Switch	 	10	Sheathed Pigtail
E38-WB24-1	Linear LED SM Light Cool White Black Body 36W 24V	 	10	Sheathed Pigtail









E39 - Fluorescent Replacement Kit

Pg 40

E39-L000-1	LED Neutral White Light Replacement Kit for P716 & P718	 	10	Pigtail
E39-L00R-1	LED Neutral White/Red Combo Light Repl Kit for P716 & P718	 	10	Pigtail
E39-L010-1	LED Neutral White Light Replacement Kit for 712XL	 	10	Pigtail

E41 - Flexible Weather Resistant Lighting Strips









Pg 29























































E41-000V-1	2 wire termination			
E41-304X-1	Flexible LED Light RGB 18" - Dual 4 -Wire Pigtail	 	-	Sheathed Pigtail (18") 2-sided
E41-A010-1	Flexible LED Light Amber 4.5" - No Wire	 		Made to Order
E41-B010-1	Flexible LED Light Blue 4.5" - No Wire	 		Made to Order
E41-G010-1	Flexible LED Light Green 4.5" - No Wire	 		Made to Order
E41-R010-1	Flexible LED Light Red 4.5" - No Wire	 		Made to Order
E41-W010-1	Flexible LED Light White 4.5" - No Wire	 		Made to Order























Available in custom length sections from 4.5" – 16.5'
*4.5" Increments only

E41 - Flexible Weather Resistant Lighting Strips

Pg 29







E44-000V-1	2 wire termination			
E44-304X-1	Flexible LED Light RGB 18" - Dual 4 -Wire Pigtail	 	-	Sheathed Pigtail (18") 2-sided
E44-A010-1	Flexible LED Light Amber 4.5" - No Wire	 		Made to Order
E44-B010-1	Flexible LED Light Blue 4.5" - No Wire	 		Made to Order
E44-G010-1	Flexible LED Light Green 4.5" - No Wire	 		Made to Order
E44-R010-1	Flexible LED Light Red 4.5" - No Wire	 		Made to Order















Part No.	Part Description	Color	STD Pack	Connector
E44-W010-1	Flexible LED Light White 4.5" - No Wire	 		Made to Order
Available in custom length sections from 4.5" – 16.5' *4.5" Increments only				
E60 - Trailer/Marine LED Recessed Mount Spotlight - One Pair				Pg 44
E60-WS20-1	Recessed Mount LED Docking Light, Pair	 	6	Sheathed Pigtail (12")
E61 - Trailer/Marine LED Surface Mount Spotlight - One Pair				Pg 44
E61-WS00-1	Surface Mount LED Docking Light, Pair	 	6	Sheathed Pigtail (12")
E96 - Trailer/Marine LED Surface Mount Spotlight - One Pair				Pg 45
E96-WS00-1	Docking Light TecNiq, Pair	 	12	9" Pigtail
E99 - Dimmer Switches				Pg 52
E99-D001-1	Dimmer Rotary		1	-
E99-D002-1	Dimmer Slide		1	-
K40 5"x 3.3" Emergency Flasher				Pg 46
K40-0100-1	K40 K50 Anchor/Screw Kit		1	-
K40-1B00-1	K40 Black Trim Ring and Gasket		1	-
K40-1C00-1	K40 Chrome Trim Ring and Gasket		1	-
K40-AA00-1	K40 AutoSync Amber Flasher Lamp Amber Lens	 	1	Pigtail
K40-AAS0-1	K40 Steady Amber Flasher Lamp Amber Lens	 	1	Pigtail
K40-AC00-1	K40 AutoSync Amber Flasher Lamp Clear Lens	 	1	Pigtail
K40-ACS0-1	K40 Steady Amber Flasher Lamp Clear Lens	 	1	Pigtail
K40-AR00-1	K40 AutoSync Amber Red Combo Flasher Lamp Clear Lens	 	1	Pigtail
K40-BB00-1	K40 AutoSync Blue Flasher Lamp Blue Lens	 	1	Pigtail
K40-BBS0-1	K40 Steady Blue Flasher Lamp Blue Lens	 	1	Pigtail
K40-BC00-1	K40 AutoSync Blue Flasher Lamp Clear Lens	 	1	Pigtail
K40-BCS0-1	K40 Steady Blue Flasher Lamp Clear Lens	 	1	Pigtail
K40-BR00-1	K40 AutoSync Blue Red Combo Flasher Lamp Clear Lens	 	1	Pigtail
K40-GG00-1	K40 AutoSync Green Flasher Lamp Green Lens	 	1	Pigtail
K40-GGS0-1	K40 Steady Green Flasher Lamp Green Lens	 	1	Pigtail
K40-GC00-1	K40 AutoSync Green Flasher Lamp Clear Lens	 	1	Pigtail
K40-GCS0-1	K40 Steady Green Flasher Lamp Clear Lens	 	1	Pigtail
K40-RC00-1	K40 AutoSync Red Flasher Lamp Clear Lens	 	1	Pigtail
K40-RCS0-1	K40 Steady Red Flasher Lamp Clear Lens	 	1	Pigtail
K40-RR00-1	K40 AutoSync Red Flasher Lamp Red Lens	 	1	Pigtail
K40-RRS0-1	K40 Steady Red Flasher Lamp Red Lens	 	1	Pigtail
K40-WA00-1	K40 AutoSync White Amber Combo Flasher Lamp Clear Lens	 	1	Pigtail
K40-WB00-1	K40 AutoSync White Blue Combo Flasher Lamp Clear Lens	 	1	Pigtail
K40-WC00-1	K40 AutoSync White Flasher Lamp Clear Lens	 	1	Pigtail
K40-WCS0-1	K40 Steady White Flasher Lamp Clear Lens	 	1	Pigtail
K40-WR00-1	K40 AutoSync White Red Combo Flasher Lamp Clear Lens	 	1	Pigtail
K50 5"x 2" Emergency Flasher				Pg 47

Part No.	Part Description	Color	STD Pack	Connector
K50-1B00-1	K50 Black Trim and Gasket Kit		1	-
K50-1C00-1	K50 Chrome Trim and Gasket Kit		1	-
K50-AA00-1	K50 AutoSync Amber Flasher Lamp Amber Lens		1	Pigtail
K50-AAS0-1	K50 Steady Amber Flasher Lamp Amber Lens		1	Pigtail
K50-AC00-1	K50 AutoSync Amber Flasher Lamp Clear Lens		1	Pigtail
K50-ACS0-1	K50 Steady Amber Flasher Lamp Clear Lens		1	Pigtail
K50-AR00-1	K50 AutoSync Amber Red Combo Flasher Lamp Clear Lens		1	Pigtail
K50-BB00-1	K50 AutoSync Blue Flasher Lamp Blue Lens		1	Pigtail
K50-BBS0-1	K50 Steady Blue Flasher Lamp Blue Lens		1	Pigtail
K50-BC00-1	K50 AutoSync Blue Flasher Lamp Clear Lens		1	Pigtail
K50-BCS0-1	K50 Steady Blue Flasher Lamp Clear Lens		1	Pigtail
K50-BR00-1	K50 AutoSync Blue Red Combo Flasher Lamp Clear Lens		1	Pigtail
K50-GG00-1	K50 AutoSync Green Flasher Lamp Green Lens		1	Pigtail
K50-GGS0-1	K50 Steady Green Flasher Lamp Green Lens		1	Pigtail
K50-GC00-1	K50 AutoSync Green Flasher Lamp Clear Lens		1	Pigtail
K50-GCS0-1	K50 Steady Green Flasher Lamp Clear Lens		1	Pigtail
K50-RC00-1	K50 AutoSync Red Flasher Lamp Clear Lens		1	Pigtail
K50-RCS0-1	K50 Steady Red Flasher Lamp Clear Lens		1	Pigtail
K50-RR00-1	K50 AutoSync Red Flasher Lamp Red Lens		1	Pigtail
K50-RRS0-1	K50 Steady Red Flasher Lamp Red Lens		1	Pigtail
K50-WA00-1	K50 AutoSync White & Amber Flasher Clear Lens		1	Pigtail
K50-WB00-1	K50 AutoSync White Blue Combo Flasher Lamp Clear Lens		1	Pigtail
K50-WC00-1	K50 AutoSync White Flasher Lamp Clear Lens		1	Pigtail
K50-WCS0-1	K50 Steady White Flasher Lamp Clear Lens		1	Pigtail
K50-WR00-1	K50 AutoSync White Red Combo Flasher Lamp Clear Lens		1	Pigtail

K60 6"x 4" Emergency Flasher





















Pg 48









































































K60-1B00-1	K60 Black Trim and Gasket Kit		1	-
K60-1C00-1	K60 Chrome Trim and Gasket Kit		1	-
K60-A3S0-1	K60 Steady Burn Amber LEDs, Amber turn, Arrow Mask		1	Pigtail
K60-AA00-1	K60 AutoSync Amber Flasher Lamp Amber Lens		1	Pigtail
K60-AAA0-1	K60 AutoSync Amber Flasher Lamp Amber Lens Arrow Mask		1	Pigtail
K60-AAS0-1	K60 Steady Amber Flasher Amber Lens		1	Pigtail
K60-AAT0-1	K60 Steady Amber Turn Amber Lens		1	Pigtail
K60-AC00-1	K60 AutoSync Amber Flasher Lamp Clear Lens		1	Pigtail
K60-ACA0-1	K60 AutoSync Amber Flasher Lamp Clear Lens Arrow Mask		1	Pigtail
K60-ACS0-1	K60 Steady Amber Flasher Clear Lens		1	Pigtail
K60-ACT0-1	K60 Steady Amber Turn Clear Lens		1	Pigtail
K60-BB00-1	K60 AutoSync Blue Flasher Lamp Blue Lens		1	Pigtail
K60-BBS0-1	K60 Steady Blue Flasher Blue Lens		1	Pigtail
K60-BC00-1	K60 AutoSync Blue Flasher Lamp Clear Lens		1	Pigtail

Part No.	Part Description	Color	STD Pack	Connector
K60-BCS0-1	K60 Steady Blue Flasher Clear Lens		1	Pigtail
K60-GG00-1	K60 AutoSync Green Flasher Lamp Green Lens		1	Pigtail
K60-GGS0-1	K60 Steady Green Flasher Green Lens		1	Pigtail
K60-GC00-1	K60 AutoSync Green Flasher Lamp Clear Lens		1	Pigtail
K60-GCS0-1	K60 Steady Green Flasher Clear Lens		1	Pigtail
K60-RC00-1	K60 AutoSync Red Flasher Lamp Clear Lens		1	Pigtail
K60-RCS0-1	K60 Steady Red Flasher Clear Lens		1	Pigtail
K60-RR00-1	K60 AutoSync Red Flasher Lamp Red Lens		1	Pigtail
K60-RRS0-1	K60 Steady Red Flasher Red Lens		1	Pigtail
K60-STC0-1	K60 Steady Red STT Clear Lens		1	Pigtail
K60-STR0-1	K60 Steady Red STT Red Lens		1	Pigtail
K60-WBU0-1	K60 White Backup Lamp		1	Pigtail
K60-WC00-1	K60 AutoSync White Flasher Lamp		1	Pigtail
K60-WCS0-1	K60 Steady White Flasher Clear Lens		1	Pigtail
K60-SW00-1	K60 High Output Scene Light		1	Pigtail

K70 7"x 3" Emergency Flasher













Pg 49





K70-0100-1	K60 K70 Anchor/Screw Kit		1	-
K70-1B00-1	K70 Black Trim and Gasket Kit		1	-
K70-1C00-1	K70 Chrome Trim and Gasket Kit		1	-
K70-AA00-1	K70 AutoSync Amber Flasher Lamp Amber Lens		1	Pigtail
K70-AAS0-1	K70 Steady Amber Flasher Amber Lens		1	Pigtail
K70-AAT0-1	K70 Steady Amber Turn Amber Lens		1	Pigtail
K70-AC00-1	K70 AutoSync Amber Flasher Lamp Clear Lens		1	Pigtail
K70-ACS0-1	K70 Steady Amber Flasher Clear Lens		1	Pigtail
K70-ACT0-1	K70 Steady Amber Turn Clear Lens		1	Pigtail
K70-BB00-1	K70 AutoSync Blue Flasher Lamp Blue Lens		1	Pigtail
K70-BBS0-1	K70 Steady Blue Flasher Lamp Blue Lens		1	Pigtail
K70-BC00-1	K70 AutoSync Blue Flasher Lamp Clear Lens		1	Pigtail
K70-BCS0-1	K70 Steady Blue Flasher Clear Lens		1	Pigtail
K70-GG00-1	K70 AutoSync Green Flasher Green Lens		1	Pigtail
K70-GGS0-1	K70 Steady Green Flasher Green Lens		1	Pigtail
K70-GC00-1	K70 AutoSync Green Flasher Clear Lens		1	Pigtail
K70-GCS0-1	K70 Steady Green Flasher Clear Lens		1	Pigtail
K70-RC00-1	K70 AutoSync Red Flasher Lamp Clear Lens		1	Pigtail
K70-RCS0-1	K70 Steady Red Flasher Clear Lens		1	Pigtail
K70-RR00-1	K70 AutoSync Red Flasher Lamp Red Lens		1	Pigtail
K70-RRS0-1	K70 Steady Red Flasher Red Lens		1	Pigtail
K70-STC0-1	K70 Steady Red STT Clear Lens		1	Pigtail
K70-STR0-1	K70 Steady Red STT Red Lens		1	Pigtail
K70-SW00-1	K70 High Output Scene Light		1	Pigtail

Part No.	Part Description	Color	STD Pack	Connector
K70-WBU0-1	K70 White Backup Lamp	 	1	Pigtail
K70-WC00-1	K70 AutoSync White Flasher Lamp	 	1	Pigtail
K70-WCS0-1	K70 Steady White Flasher Clear Lens	 	1	Pigtail
K90 9"x 7" Emergency Flasher				Pg 50
K90-0100-1	K90 Anchor/Screw Kit		1	-
K90-1B00-1	K90 Black Trim and Gasket Kit		1	-
K90-1C00-1	K90 Chrome Trim and Gasket Kit		1	-
K90-AA00-1	K90 AutoSync Amber Flasher Lamp Amber Lens	 	1	Pigtail
K90-AAT0-1	K90 Steady Amber Turn Amber Lens	 	1	Pigtail
K90-AAS0-1	K90 Steady Amber Flasher Lamp Amber Lens	 	1	Pigtail
K90-AC00-1	K90 AutoSync Amber Flasher Lamp Clear Lens	 	1	Pigtail
K90-ACS0-1	K90 Steady Amber Flasher Lamp Clear Lens	 	1	Pigtail
K90-ACT0-1	K90 Steady Amber Amber Flasher Lamp Clear Lens	 	1	Pigtail
K90-AS00-1	K90 AutoSync Amber Flasher White Scene Clear Lens	 	1	Pigtail
K90-BB00-1	K90 AutoSync Blue Flasher Lamp Blue Lens	 	1	Pigtail
K90-BBS0-1	K90 Steady Blue Flasher Lamp Blue Lens	 	1	Pigtail
K90-BBU0-1	K90 Steady Blue Flasher Back Up Clear Lens	 	1	Pigtail
K90-BC00-1	K90 AutoSync Blue Flasher Lamp Clear Lens	 	1	Pigtail
K90-BCS0-1	K90 Steady Blue Flasher Lamp Clear Lens	 	1	Pigtail
K90-BS00-1	K90 AutoSync Blue Flasher White Scene Clear Lens	 	1	Pigtail
K90-GC00-1	K90 AutoSync Green Flasher Lamp Clear Lens	 	1	Pigtail
K90-GG00-1	K90 AutoSync Green Flasher Lamp Green Lens	 	1	Pigtail
K90-GCS0-1	K90 Steady Green Flasher Lamp Clear Lens	 	1	Pigtail
K90-GGS0-1	K90 Steady Green Flasher Lamp Green Lens	 	1	Pigtail
K90-RA00-1	K90 AutoSync Red Amber Flasher Lamp Clear Lens	 	1	Pigtail
K90-RAS0-1	K90 Steady Red Amber Flasher Lamp Clear Lens	 	1	Pigtail
K90-RB00-1	K90 AutoSync Red Blue Flasher Lamp Clear Lens	 	1	Pigtail
K90-RBS0-1	K90 Steady Red Blue Flasher Lamp Clear Lens	 	1	Pigtail
K90-RC00-1	K90 AutoSync Red Red Flasher Lamp Clear Lens	 	1	Pigtail
K90-RCS0-1	K90 Steady Red Flasher Lamp Clear Lens	 	1	Pigtail
K90-RR00-1	K90 AutoSync Red Flasher Lamp Red Lens	 	1	Pigtail
K90-RRS0-1	K90 Steady Red Flasher Lamp Red Lens	 	1	Pigtail
K90-RS00-1	K90 AutoSync Red Flasher White Scene Clear Lens	 	1	Pigtail
K90-RW00-1	K90 AutoSync Red White Flasher Lamp Clear Lens	 	1	Pigtail
K90-RWS0-1	K90 Steady Red White Flasher Lamp Clear Lens	 	1	Pigtail
K90-STAA0-1	K90 Steady Red STT Top Amber Autosync Bottom Clear Lens	 	1	Pigtail
K90-STC0-1	K90 Steady Red STT Lamp Clear Lens	 	1	Pigtail
K90-STR0-1	K90 Steady Red STT Lamp Red Lens	 	1	Pigtail
K90-STSO-1	K90 Steady Red STT Bottom Scene Clear Lens	 	1	Pigtail
K90-SW00-1	K90 High Output Scene Light	 	1	Pigtail

Part No.	Part Description	Color	STD Pack	Connector
K90-WB00-1	K90 AutoSync White Blue Flasher Lamp Clear Lens		1	Pigtail
K90-WBS0-1	K90 Steady White Blue Flasher Lamp Clear Lens		1	Pigtail
K90-WBU0-1	K90 White Backup Lamp		1	Pigtail
K90-WC00-1	K90 AutoSync White Flasher Lamp Clear Lens		1	Pigtail
K90-WCS0-1	K90 Steady White Flasher Lamp Clear Lens		1	Pigtail





















Other Combinations Available. Call for Details





























































Lxx - License Plate Lamp				Pg 16-17
L10-WB00-1	Black Base License Lamp Vertical Plane Mount		10	Sheathed Pigtail
L10-WB9B-1	Black Base License Lamp Vertical Plane Mount w/.180 Bullet		10	0.180" Bullets
L10-WC00-1	Chrome Base License Lamp Vertical Plane Mount		10	Sheathed Pigtail
L11-WB00-1	Black Base License Lamp Vertical Plane Mount		10	Sheathed Pigtail
L11-WB9B-1	Black Base License Lamp Vertical Plane Mount w/.180" Bullets		10	0.180" Bullets
L11-WB9N-1	Black Base License Lamp Vertical Plane Mount w/.156" Barrels		10	0.156" Barrels
L11-WC00-1	Chrome Base License Lamp Vertical Plane Mount		10	Sheathed Pigtail
L11-WC9N-1	Chrome Base License Lamp Vertical Plane Mount / .156 Barrel		10	0.156" Barrels
L12-WB00-1	Black Base License Lamp Horizontal Plane Mount		10	Sheathed Pigtail
L12-WB5B-1	Black Base License Lamp Horizontal Plane Mount w/.180" Bullets		10	0.180" Bullets
L12-WC00-1	Chrome Base License Lamp Horizontal Plane Mount		10	Sheathed Pigtail
L34-WC9B-1	3/4" Bullet style License Lamp, Large Grommet w/ .180 bullets		10	0.180" Bullets
L34-WG9B-1	3/4" Bullet Style License Lamp, Standard Grommet w/ .180 bullets		10	0.180" Bullets
L95-0B00-1	License Plate Bracket, Black			















M90 - Interior Accent Light				Pg 27
M90-BS00-1	Interior Accent Light, Blue LED, SS Cover		50	Sheathed Pigtail (9")
M90-GS00-1	Interior Accent Light, Green LED, SS Cover		50	Sheathed Pigtail (9")
M90-RS00-1	Interior Accent Light, Red LED, SS Cover		50	Sheathed Pigtail (9")
M90-WS00-1	Interior Accent Light, White LED, SS Cover		50	Sheathed Pigtail (9")

P0x - SteelHead Work Lights				Pg 32
P02-WBSP-1	SteelHead Spot Lamp 2 LED Black Finish Pigtail wires		4	Sheathed Pigtail
P02-WBFP-1	SteelHead Flood Lamp 2 LED Black Finish Pigtail wires		4	Sheathed Pigtail
P04-WBSP-1	SteelHead Spot Lamp 4 LED Black Finish Pigtail wires		2	Sheathed Pigtail
P04-WBFP-1	SteelHead Flood Lamp 4 LED Black Finish Pigtail wires		2	Sheathed Pigtail
P06-WBSP-1	SteelHead Spot Lamp 6 LED Black Finish Pigtail wires		2	Sheathed Pigtail
P06-WBFP-1	SteelHead Flood Lamp 6 LED Black Finish Pigtail wires		2	Sheathed Pigtail
P02-WWSP-1	SteelHead Spot Lamp 2 LED White Finish Pigtail wires		4	Sheathed Pigtail
P02-WWFP-1	SteelHead Flood Lamp 2 LED White Finish Pigtail wires		4	Sheathed Pigtail
P04-WWSP-1	SteelHead Spot Lamp 4 LED White Finish Pigtail wires		2	Sheathed Pigtail
P04-WWFP-1	SteelHead Flood Lamp 4 LED White Finish Pigtail wires		2	Sheathed Pigtail
P06-WWSP-1	SteelHead Spot Lamp 6 LED White Finish Pigtail wires		2	Sheathed Pigtail
P06-WWFP-1	SteelHead Flood Lamp 6 LED White Finish Pigtail wires		2	Sheathed Pigtail

P10 - Flush Mount Spreader Light				Pg 33
----------------------------------	--	--	--	-------





































Part No.	Part Description	Color	STD Pack	Connector
P10-WWFP-1	Spreader Light, White LED, White Finish, Pigtail Wires		2	Sheathed Pigtail (9")
P10-WRFP-1	Spreader Light, White & Red LED, White Finish, Pigtail Wires		2	Sheathed Pigtail (9")
P11 - Surface Mount Spreader Light				Pg 33
P11-WWFP-1	Spreader Light, White LED, White Finish, Pigtail Wires		2	Sheathed Pigtail (9")
P11-WRFP-1	Spreader Light, White & Red LED, White Finish, Pigtail Wires		2	Sheathed Pigtail (9")
Rxx - Conspicuity Reflectors				Pg 25
R03-0A00-1	Amber 3" Round SAE Reflector - Roll of 100		1	
R03-0R00-1	Red 3" Round SAE Reflector - Roll of 100		1	
R05-0A00-1	Amber 2" x 3.5" Rectangular SAE Reflector - Roll of 500		1	
R05-0R00-1	Red 2" x 3.5" Rectangular SAE Reflector - Roll of 500		1	
R10-0RW0-1	Red 11"x White 7" OEM Grade SAE DOT Stripe Reflector - 150' Roll		1	
S10 - 2.5" Round P2 Rated Sidemarker				Pg 23
S10-0G00-1	2.5" Round Sidemarker Grommet		150	-
S10-AA00-1	2.5" Round Amber P2 Sidemarker with Reflectivity		150	Fem 2 Pole
S10-RR00-1	2.5" Round Red P2 Sidemarker with Reflectivity		150	Fem 2 Pole
S14 - PC/P2 Rated Sidemarker				Pg 18
S14-AAS0-1	S14 Amber PCP2 Stud Mount Marker Light Amber Lens Pigtail		100	Pigtail
S14-AAS1-1	S14 Amber PCP2 Stud Mount Marker Light Amber Lens 10" Pigtail		100	Pigtail
S14-ACS0-1	S14 Amber PCP2 Stud Mount Marker Light Clear Lens Pigtail		100	Pigtail
S14-RCS0-1	S14 Red PCP2 Stud Mount Marker Light Clear Lens Pigtail		100	Pigtail
S14-RRS0-1	S14 Red PCP2 Stud Mount Marker Light Red Lens Pigtail		100	Pigtail
S14-RRS1-1	S14 Red PCP2 Stud Mount Marker Light Red Lens 10" Pigtail		100	Pigtail
S15 - PC Rated Sidemarker				Pg 24
S15-0B00-1	Model S150 Base Black		100	-
S15-0S00-1	Model S150 Base Chrome		100	-
S15-0G00-1	Model S150 Grommet		100	-
S15-AA00-1	Model S150 Amber PC Sidemarker Amber Lens		120	Fem 2 Pole
S15-AC00-1	Model S150 Amber PC Sidemarker Clear Lens		120	Fem 2 Pole
S15-AC0P-1	Model S150 Amber PC Sidemarker Clear Lens 6" Pigtail		200	Pigtail
S15-RC00-1	Model S150 Red PC Sidemarker Clear Lens		120	Fem 2 Pole
S15-RC0P-1	Model S150 Red PC Sidemarker Clear Lens 6" Pigtail		200	Pigtail
S15-RR00-1	Model S150 Red PC Sidemarker Red Lens		120	Fem 2 Pole
S17 - PC/P2 Rated Sidemarker				Pg 18
S17-0B00-1	Model S170 Black Base		100	-
S17-0G00-1	Model S170 Gasket - Small		100	-
S17-0C00-1	Model S170 Chrome Base		100	-
S17-0GC0-1	Model S170 Chrome Base & Gasket - Large		100	-
S17-AA0P-1	Model S170 Amber P2/PC Sidemarker Amber Lens 6" Pigtail		100	Pigtail
S17-AAG0-1	Model S170 Amber P2/PC Sidemarker Amber Lens Self Ground		100	Pigtail / Self grounded
S17-AC0P-1	Model S170 Amber P2/PC Sidemarker Clear Lens 6" Pigtail		100	Pigtail

Part No.	Part Description	Color	STD Pack	Connector
S17-ACG0-1	Model S170 Amber P2/PC Sidemarker Clear Lens Self Ground	 	100	Pigtail / Self grounded
S17-AC0M-1	Model S170 Amber P2/PC Sidemarker Clear Lens .156 Bullet	 	100	0.156" Bullets
S17-RC0P-1	Model S170 Red P2/PC Sidemarker Clear Lens 6" Pigtail	 	100	Pigtail
S17-RCG0-1	Model S170 Red P2/PC Sidemarker Clear Lens Self Ground	 	100	Pigtail / Self grounded
S17-RC0M-1	Model S170 Red P2/PC Sidemarker Clear Lens w/ .156 Bullets	 	100	0.156" Bullets
S17-RR0P-1	Model S170 Red P2/PC Sidemarker Red Lens 6" Pigtail	 	100	Pigtail
S17-RRG0-1	Model S170 Red P2/PC Sidemarker Red Lens Self Ground	 	100	Pigtail / Self grounded
S18 - PC/P2 Rated Sidemarker				Pg 19
S18-AA00-1	3.5"x.75" Surface mount P2/PC rated Amber sidemarker Hardwired	 	100	Pigtail
S18-AAG0-1	3.5"x.75" Surface mount P2/PC rated Amber Sidemarker Self Ground	 	100	Pigtail / Self grounded
S18-AC00-1	3.5"x.75" Surface mountP2/ PC rated Amber/Clr sidemarker Hardwired	 	100	Pigtail
S18-ACG0-1	3.5"x.75" Surface mount P2/PC rated Amber/Clr sidemarker Self Ground	 	100	Pigtail / Self grounded
S18-RC00-1	3.5"x.75" Surface mount P2/PC rated Red/Clear sidemarker Hardwired	 	100	Pigtail
S18-RCG0-1	3.5"x.75" Surface mount P2/PC rated Red/Clear sidemarker Self Ground	 	100	Pigtail / Self grounded
S18-RR00-1	3.5"x.75" Surface mount P2/PC rated Red sidemarker Hardwired	 	100	Pigtail
S18-RRG0-1	3.5"x.75" Surface mount P2/PC rated Red sidemarker Self Ground	 	100	Pigtail / Self grounded
S18-WC00-1	3.5"x.75" Surface Mount Area Light hardwired	 	100	Pigtail
S19 - PC Rated Sidemarker				Pg 24
S19-0B00-1	Black 1" x4" Self Grounding Base		120	-
S19-0C00-1	Chrome 1" x4" Self Grounding Base		120	-
S19-AA00-1	1"x4" Amber PC Sidemarker Amber Lens	 	120	Self-grounding base
S19-AC00-1	1"x4" Amber PC Sidemarker Clear Lens	 	120	Self-grounding base
S19-RC00-1	1"x4" Red PC Sidemarker Clear Lens	 	120	Self-grounding base
S19-RR00-1	1"x4" Red PC Sidemarker Red Lens	 	120	Self-grounding base
S21 - P2 Rated Sidemarker				Pg 22
S21-0G00-1	Sidemarker Gasket		100	-
S21-0G20-1	Sidemarker Molded Rubber Gasket		100	-
S21-0S00-1	2" Oval Sidemarker SS Trim Ring		100	-
S21-AA00-1	2" Oval Amber Sidemarker Amber Lens Pigtail Connection	 	100	Sheathed Pigtail
S21-AAG0-1	2" Oval Amber Sidemarker Amber Lens Self Grounding	 	100	Pigtail / Self grounded
S21-AC00-1	2" Oval Amber Sidemarker Clear Lens Pigtail Connection	 	100	Sheathed Pigtail
S21-ACG0-1	2" Oval Amber Sidemarker Clear Lens Self Grounding	 	100	Pigtail / Self grounded
S21-RC00-1	2" Oval Red Sidemarker Clear Lens Pigtail Connection	 	100	Sheathed Pigtail
S21-RCG0-1	2" Oval Red Sidemarker Clear Lens Self Grounding	 	100	Pigtail / Self grounded
S21-RR00-1	2" Oval Red Sidemarker Red Lens Pigtail Connection	 	100	Sheathed Pigtail
S21-RRG0-1	2" Oval Red Sidemarker Red Lens Self Grounding	 	100	Pigtail / Self grounded
S22 - 2"x 6" PC Sidemarker				Pg 25
S22-AA00-1	Amber 2" x 6" PC Sidemarker with reflector	 	100	Two Pole (spade)
S22-RR00-1	Red 2" x 6" PC Sidemarker with reflector	 	100	Two Pole (spade)
S30 - 2" round P2 Rated Sidemarker				Pg 23

Part No.	Part Description	Color	STD Pack	Connector
S30-0G00-1	2" Round Sidemarker Grommet		125	-
S30-AA00-1	2" Round Amber Sidemarker Amber Lens	 	125	Fem 2 Pole
S30-AA0P-1	2" Round Amber Sidemarker Amber Lens w/ Pig Tail	 	125	Pigtail
S30-AC00-1	2" Round Amber Sidemarker Clear Lens	 	125	Fem 2 Pole
S30-RC00-1	2" Round Red Sidemarker Clear Lens	 	125	Fem 2 Pole
S30-RC0P-1	2" Round Red Sidemarker Clear Lens w/ Pig Tail	 	125	Pigtail
S30-RR00-1	2" Round Red Sidemarker Red Lens	 	125	Fem 2 Pole
S30-RR0P-1	2" Round Red Sidemarker Red Lens w/ Pig Tail	 	125	Pigtail











S33 - P2 Rated Sidemarker









































Pg 20/28

S33-0S00-1	Stainless Steel Trim Ring for S33 and S34		100	-
S33-AA00-1	3/4" Mini P2 Amber Sidemarker Amber Lens	 	100	Sheathed Pigtail
S33-AA09-1	3/4" Mini P2 Amber Sidemarker Amber Lens, white ground wire	 	100	Sheathed Pigtail
S33-AA9B-1	3/4" Mini P2 Amber Sidemarker Amber Lens w/.180 Bullet	 	100	0.180" Bullets
S33-AA9H-1	Amber Mini P2 Sidemarker Amber Lens 18" Black Positive	 	100	Sheathed Pigtail (18")
S33-AAFB-1	3/4" Mini P2 Amber Sidemarker Amber Lens 18" wire w/.180 Bul	 	100	0.180" Bullets (18")
S33-AC00-1	3/4" Mini P2 Amber Sidemarker Clear Lens	 	100	Sheathed Pigtail
S33-AC09-1	3/4" Mini P2 Amber Sidemarker Clear Lens, white ground wire	 	100	Sheathed Pigtail
S33-AC9B-1	3/4" Mini P2 Amber Sidemarker Clear Lens w/.180 Bullet	 	100	0.180" Bullets
S33-AC9H-1	Amber Mini P2 Sidemarker Clear Lens 18" Black Positive	 	100	Sheathed Pigtail (18")
S33-ACFB-1	3/4" Mini P2 Amber Sidemarker Clear Lens 18" wire w/.180 Bul	 	100	0.180" Bullets (18")
S33-BC00-1	3/4" Round Low Profile Blue Indicator	 	100	Sheathed Pigtail
S33-GC00-1	3/4" Round Low Profile Green Indicator	 	100	Sheathed Pigtail
S33-RC00-1	3/4" Mini P2 Red Sidemarker Clear Lens	 	100	Sheathed Pigtail
S33-RC09-1	3/4" Mini P2 Red Sidemarker Clear Lens white ground wire	 	100	Sheathed Pigtail
S33-RC9B-1	3/4" Mini P2 Red Sidemarker Clear Lens w/.180 Bullet	 	100	0.180" Bullets
S33-RC9H-1	Red P2 Sidemarker Clear Lens 18" White Ground	 	100	Sheathed Pigtail (18")
S33-RCFB-1	3/4" Mini P2 Red Sidemarker Clear Lens 18" wire w/.180 Bulle	 	100	0.180" Bullets (18")
S33-RR00-1	3/4" Mini P2 Red Sidemarker Red Lens	 	100	Sheathed Pigtail
S33-RR09-1	3/4" Mini P2 Red Sidemarker Red Lens white ground wire	 	100	Sheathed Pigtail
S33-RR9B-1	3/4" Mini P2 Red Sidemarker Red Lens w/.180 Bullet	 	100	0.180" Bullets
S33-RR9H-1	Red P2 Sidemarker Clear Lens 18" Black Positive	 	100	Sheathed Pigtail (18")
S33-RRFB-1	3/4" Mini P2 Red Sidemarker Red Lens 18" wire w/.180 Bullet	 	100	0.180" Bullets (18")
S33-WC00-1	3/4" Round Low Profile White Indicator	 	100	Sheathed Pigtail
S33-WC0B-1	3/4" Round Low Profile White Indicator w/ .180" Bullets	 	100	0.180" Bullets

S34 - PC Rated Sidemarker

Pg 20

S34-AA00-1	Amber Mini PC Sidemarker Amber Lens	 	100	Sheathed Pigtail
S34-AA09-1	Amber Mini PC Sidemarker Amber Lens white ground wire	 	100	Sheathed Pigtail
S34-AA9B-1	Amber Mini PC Sidemarker Amber Lens w/.180 Bullet	 	100	0.180" Bullets
S34-AA9H-1	Amber Mini PC Sidemarker Amber Lens 18" Lead Black Positive	 	100	Sheathed Pigtail (18")
S34-AA20-1	Amber Mini PC Sidemarker Amber Lens Dual Intensity Pigtail	 	100	Sheathed Pigtail

Part No.	Part Description	Color	STD Pack	Connector
S34-AC00-1	Amber Mini PC Sidemarker Clear Lens	 	100	Sheathed Pigtail
S34-AC09-1	Amber Mini PC Sidemarker Clear Lens white ground wire	 	100	Sheathed Pigtail
S34-AC9B-1	Amber Mini PC Sidemarker Clear Lens w/.180 Bullet	 	100	0.180" Bullets
S34-AC9H-1	Amber Mini PC Sidemarker Clear Lens 18" Lead Black Positive	 	100	Sheathed Pigtail (18")
S34-BC00-1	Blue Mini PC Sidemarker Clear Lens	 	100	Sheathed Pigtail
S34-BC0M-1	Blue Mini PC Sidemarker Clear Lens w/ .156 Bullet	 	100	0.156" Bullets
S34-GC0M-1	Green Mini PC Sidemarker Clear Lens w/ .156 Bullet	 	100	0.156" Bullets
S34-RC00-1	Red Mini PC Sidemarker Clear Lens	 	100	Sheathed Pigtail
S34-RC09-1	Red Mini PC Sidemarker Clear Lens white ground wire	 	100	Sheathed Pigtail
S34-RC9B-1	Red Mini PC Sidemarker Clear Lens w/.180 Bullet	 	100	0.180" Bullets
S34-RC9H-1	Red Mini PC Sidemarker Clear Lens 18" Lead Black Positive	 	100	Sheathed Pigtail (18")
S34-RR00-1	Red Mini PC Sidemarker Red Lens	 	100	Sheathed Pigtail
S34-RR09-1	Red Mini PC Sidemarker Red Lens white ground wire	 	100	Sheathed Pigtail
S34-RR20-1	Red Mini PC Sidemarker Red Lens Dual Intensity Pigtail	 	100	Sheathed Pigtail
S34-RR30-1	Red Mini 3 Light PC Over 80 ID assembly 12" Lead	 	100	Sheathed Pigtail
S34-RR9B-1	Red Mini PC Sidemarker Red Lens w/.180 Bullet	 	100	0.180" Bullets
S34-RR9H-1	Red Mini PC Sidemarker Red Lens 18" Lead Black Positive	 	100	Sheathed Pigtail (18")
S34-RR31-1	Red Mini 3 Light PC Over 80 ID assembly 48" Lead	 	100	Sheathed Pigtail
S34-WC00-1	White Mini PC Sidemarker Clear Lens	 	100	Sheathed Pigtail
S34-WC0M-1	White Mini PC Sidemarker Clear Lens w/ .156 Bullet	 	100	0.156" Bullets



S36 - Sidemarker

Pg 22

S36-AA10-1	S36 Amber P2 Sidemarker Amber Lens	 	100	Two Pole (spade)
S36-AA20-1	S36 Amber PC Sidemarker Amber Lens	 	100	Two Pole (spade)
S36-AC10-1	S36 Amber P2 Sidemarker Clear Lens	 	100	Two Pole (spade)
S36-AC20-1	S36 Amber PC Sidemarker Clear Lens	 	100	Two Pole (spade)
S36-RC20-1	S36 Red PC Sidemarker Clear Lens	 	100	Two Pole (spade)
S36-RC10-1	S36 Red P2 Sidemarker Clear Lens	 	100	Two Pole (spade)
S36-RR10-1	S36 Red P2 Sidemarker Red Lens	 	100	Two Pole (spade)
S36-RR20-1	S36 Red PC Sidemarker Red Lens	 	100	Two Pole (spade)

















































S37 - Sidemarker

































Pg 21

S37-AA09-1	Amber Mini Grommet Mount PC Sidemarker Amber Lens	 	100	Sheathed Pigtail
S37-AC09-1	Amber Mini Grommet Mount PC Sidemarker Clear Lens	 	100	Sheathed Pigtail
S37-BC09-1	Blue Mini Grommet Mount Accent Light Clear Lens	 	100	Sheathed Pigtail
S37-GC09-1	Green Mini Grommet Mount Accent Light Clear Lens	 	100	Sheathed Pigtail
S37-RC09-1	Red Mini Grommet Mount PC Sidemarker Clear Lens	 	100	Sheathed Pigtail
S37-RR09-1	Red Mini Grommet Mount PC Sidemarker Red Lens	 	100	Sheathed Pigtail
S37-WC09-1	White Mini Grommet Mount Accent Light Clear Lens	 	100	Sheathed Pigtail

S38 - Sidemarker









































Pg 21





































Part No.	Part Description	Color	STD Pack	Connector
S38-AA09-1	Amber Mini Surface Mount PC Sidemarker Amber Lens	 	100	Sheathed Pigtail
S38-AC09-1	Amber Mini Surface Mount PC Sidemarker Clear Lens	 	100	Sheathed Pigtail
S38-BC09-1	Blue Mini Surface Mount Accent Light Clear Lens	 	100	Sheathed Pigtail
S38-GC09-1	Green Mini Surface Mount Accent Light Clear Lens	 	100	Sheathed Pigtail
S38-RC09-1	Red Mini Surface Mount PC Sidemarker Clear Lens	 	100	Sheathed Pigtail
S38-RR09-1	Red Mini Surface Mount PC Sidemarker Red Lens	 	100	Sheathed Pigtail
S38-WC09-1	White Mini Surface Mount Accent Light Clear Lens	 	100	Sheathed Pigtail
S50 - Heavy Duty ID Bar				Pg 12
S50-AAB0-1	Tri-Bar Amber Amber Lens Black Body	 	25	Sheathed Pigtail
S50-ACB0-1	Tri-Bar Amber Clear Lens Black Body	 	25	Sheathed Pigtail
S50-RCB0-1	Tri-Bar Red Clear Lens Black Body	 	25	Sheathed Pigtail
S50-RRB0-1	Tri-Bar Red Red Lens Black Body	 	25	Sheathed Pigtail
S51 - Heavy Duty ID Bar				Pg 12
S51-AA00-1	Tri-Bar Amber LED, Amber Lens, Black Body, Pigtail	 	25	Sheathed Pigtail
S51-AC00-1	Tri-Bar Amber LED, Clear Lens, Black Body, Pigtail	 	25	Sheathed Pigtail
S51-RC00-1	Tri-Bar Red LED, Clear Lens, Black Body, Pigtail	 	25	Sheathed Pigtail
S51-RR00-1	Tri-Bar Red LED, Red Lens, Black Body, Pigtail	 	25	Sheathed Pigtail
S52 - V-shaped ID Bar				Pg 13
S52-RC00-1	V-Shaped Over 80" Tri-Bar Red LED, Clear Lens, Pigtail	 	25	Sheathed Pigtail
S52-RC10-1	V-Shaped Over 80" Tri-Bar Red LED, Clear Lens, 58" Pigtail	 	25	58" Sheathed Pigtail
S52-RR00-1	V-Shaped Over 80" Tri-Bar Red LED, Red Lens, Pigtail	 	25	Sheathed Pigtail
S52-RR10-1	V-Shaped Over 80" Tri-Bar Red LED, Red Lens, 58" Pigtail	 	25	58" Sheathed Pigtail
S90 - Heavy Duty Miniature Bi-color Fender Light				Pg 26
S90-0000-1	Fender Sidemarker Light	 	150	Pigtail
S90-000M-1	Fender Sidemarker Light w/ .156 Bullet	 	150	0.156" Bullet
S90-002B-1	Fender Sidemarker Light w/20" Wire #10 GND Ring .180 Bullet	 	150	0.180" Bullet/ GND Ring
S90-00G0-1	Fender Sidemarker Light with Grounding Ring		150	-
S90-0B00-1	Fender Sidemarker Light Wire Guide Black		150	-
S90-0B20-1	Fender Sidemarker Light Wall Cover Black		150	-
S90-0BS0-1	Fender Sidemarker Light Wire Guide 4 Hole Black		150	-
S90-0C00-1	Fender Sidemarker Light Wire Guide Chrome		150	-
S90-0C20-1	Fender Sidemarker Light Wall Cover Chrome		150	-
S90-0CS0-1	Fender Sidemarker Light Wire Guide 4 Hole Chrome		150	-
S90-0SS0-1	Fender Sidemarker Light SS Stamping		150	-
S91 - Heavy Duty Miniature Bi-color Fender Light				Pg 26
S91-AR00-1	Fender Sidemarker Light, Red/Amber Lens Pigtail	 	100	100
S91-ARC0-1	Fender Sidemarker Light, Clear Lens, Red/Amber LED Pigtail	 	100	100
T1x - Low Profile Tail Light/ID Bar				Pg 11/13
T10-0B00-1	Black Bezel		100	-
T10-0C00-1	Chrome Bezel		100	-

Part No.	Part Description	Color	STD Pack	Connector
T10-AA00-1	Amber Low Profile Turn Sidemarker Amber Lens	 	100	Pigtail
T10-AC00-1	Amber Low Profile Turn Sidemarker Clear Lens	 	100	Pigtail
T10-LC00-1	Low Profile Auxiliary Light	 	100	Pigtail
T10-LC0M-1	Low Profile Auxiliary Light w/ .156 bullets (black wire is ground)	 	100	0.156" Bullets
T10-LC9M-1	Low Profile Auxiliary Light w/ .156 bullets (black wire is positive)	 	100	0.156" Bullets
T10-RC00-1	Red Low Profile STT Clear Lens	 	100	Pigtail
T10-RC0M-1	Red Low Profile STT Clear Lens w/ .156 bullets	 	100	0.156" Bullets
T10-RR00-1	Red Low Profile STT Red Lens	 	100	Pigtail
T10-RR0B-1	Red Low Profile STT Red Lens Pigtail w/ 0.180" M. Bullets	 	100	0.180" Bullets
T10-RR0M-1	Red Low Profile STT Red Lens Pigtail w/ 0.156 Bullets	 	100	0.156" Bullets
T12-AA00-1	Amber Low Profile ID Bar Amber Lens	 	100	Pigtail
T12-AC00-1	Amber Low Profile ID Bar Clear Lens	 	100	Pigtail
T12-RC00-1	Red Low Profile ID Bar Clear Lens	 	100	Pigtail
T12-RR00-1	Red Low Profile ID Bar Red Lens	 	100	Pigtail
T12-RR0B-1	Red Low Profile ID Bar Red Lens PigTail w/.180" Bullets	 	100	0.180" Bullets
T12-RW00-1	Red ID Bar/Load Lamp Clear Lens	 	100	Pigtail

T40 - 4" Round Stop-Turn-Tail

Pg 5

T40-0G00-1	4" Round Grommet		100	-
T40-0G20-1	4" Round Grommet High Grip		100	-
T40-0S00-1	4" Round Trim Ring SS		100	-
T40-AA0A-1	4" Round Amber Turn Lamp Amber Lens Grommet Mount Amp Connector	 	100	Amp
T40-AA0P-1	4" Round Amber Turn Lamp Amber Lens Grommet Mount w/Pig Tail	 	100	Pigtail
T40-AA0T-1	4" Round Amber Turn Lamp Amber Lens Grommet Mount 3 Pole	 	100	Tri Pole
T40-AAFA-1	4" Round Amber Turn Lamp Amber Lens Flange Mount Amp Connector	 	100	Amp
T40-AAFB-1	4" Round Amber Turn Lamp Amber Lens Flange 0.180 Bullet	 	100	0.180" Bullets
T40-AAFP-1	4" Round Amber Turn Lamp Amber Lens Flange Mount w/Pig Tail	 	100	Pigtail
T40-AAFT-1	4" Round Amber Turn Lamp Amber Lens Flange Mount 3 Pole	 	100	Tri Pole
T40-AC0A-1	4" Round Amber Turn Lamp Clear Lens Grommet Mount Amp Connector	 	100	Amp
T40-AC0P-1	4" Round Amber Turn Lamp Clear Lens Grommet Mount w/Pig Tail	 	100	Pigtail
T40-AC0T-1	4" Round Amber Turn Lamp Clear Lens Grommet Mount 3 Pole	 	100	Tri Pole
T40-ACFA-1	4" Round Amber Turn Lamp Clear Lens Flange Mount Amp Connector	 	100	Amp
T40-ACFP-1	4" Round Amber Turn Lamp Clear Lens Flange Mount w/Pig Tail	 	100	Pigtail
T40-ACFT-1	4" Round Amber Turn Lamp Clear Lens Flange Mount 3 Pole	 	100	Tri Pole
T40-RC0A-1	4" Round STT Lamp Clear Lens Grommet Mount Amp Connector	 	100	Amp
T40-RC0P-1	4" Round STT Lamp Clear Lens Grommet Mount w/Pig Tail	 	100	Pigtail
T40-RC0T-1	4" Round STT Lamp Clear Lens Grommet Mount 3 Pole	 	100	Tri Pole
T40-RCFA-1	4" Round STT Lamp Clear Lens Flange Mount Amp Connector	 	100	Amp
T40-RCFP-1	4" Round STT Clear Lens Flange Mount w/Pig Tail	 	100	Pigtail
T40-RCFT-1	4" Round STT Lamp Clear Lens Flange Mount 3 Pole	 	100	Tri Pole
T40-RR0A-1	4" Round STT Lamp Red Lens Grommet Mount Amp Connector	 	100	Amp

Part No.	Part Description	Color	STD Pack	Connector
T40-RR0B-1	4" Round STT Lamp Red Lens Grommet Mount Pig Tail w/.180 Bullet		100	0.180" Bullets
T40-RR0P-1	4" Round STT Lamp Red Lens Grommet Mount w/Pig Tail		100	Pigtail
T40-RR0T-1	4" Round STT Lamp Red Lens Grommet Mount 3 Pole		100	Tri Pole
T40-RRFA-1	4" Round STT Red Lens Flange Mount Amp Connector		100	Amp
T40-RRFB-1	4" Round STT Red Lamp Red Lens Pig Tail w/.180 Bullet		100	0.180" Bullets
T40-RRFP-1	4" Round STT Red Lens Flange Mount w/Pig Tail		100	Pigtail
T40-RRFT-1	4" Round STT Red Lens Flange Mount 3 Pole		100	Tri Pole
T41 - 4" Round Reverse Lamp				Pg 14
T41-WC0A-1	4" Round 2x Reverse Lamp Grommet Amp		100	Amp
T41-WC0B-1	4" Round 2X Reverse Lamp Grommet .180 Bullet		100	0.180" Bullets
T41-WC0P-1	4" Round 2x Reverse Lamp Grommet w/Pig Tail		100	Pigtail
T41-WC0T-1	4" Round 2x Reverse Lamp Grommet 3 Pole		100	Tri Pole
T41-WCFA-1	4" Round 2X Reverse Lamp Clear Lens Flange Mount Amp		100	Amp
T41-WCFP-1	4" Round 2X Reverse Lamp Clear Lens Flange Mount Pigtail		100	Pigtail
T41-WCFT-1	4" Round 2X Reverse Lamp Clear Lens Flange Mount 3 Pole		100	Tri Pole
T44 - 4" Interior Dome Light				Pg 43
T44-WD0B-1	4" Round 8 LED Grommet Mount Dome Light w/ .180 Bullets		100	0.180" Bullets
T44-WDFB-1	4" Round 8 LED Flange Mount Dome Light w/ .180 Bullets		100	0.180" Bullets
T45 - 4" Round Hi Visibility Stop/Turn/Tail/Reverse Combo Light				Pg 8
T45-RC0A-1	4" Round STTR Clear Lens Grommet Mount Amp		100	Amp
T45-RC0P-1	4" Round STTR Clear Lens Grommet Mount Pig-Tail		100	Pigtail
T45-RC0T-1	4" Round STTR Clear Lens Grommet Mount Tri-Pole		100	Tri Pole
T45-RCFA-1	4" Round STTR Clear Lens Flange Mount Amp		100	Amp
T45-RCFP-1	4" Round STTR Clear Lens Flange Mount Pig-Tail		100	Pigtail
T45-RCFT-1	4" Round STTR Clear Lens Flange Mount Tri-Pole		100	Tri Pole
T45-RW0A-1	4" Round STTR Red Lens Grommet Mount Amp		100	Amp
T45-RW0P-1	4" Round STTR Red Lens Grommet Mount Pig-Tail		100	Pigtail
T45-RW0T-1	4" Round STTR Red Lens Grommet Mount Tri-Pole		100	Tri Pole
T45-RWFA-1	4" Round STTR Red Lens Flange Mount Amp		100	Amp
T45-RWFP-1	4" Round STTR Red Lens Flange Mount Pig-Tail		100	Pigtail
T45-RWFT-1	4" Round STTR Red Lens Flange Mount Tri-Pole		100	Tri Pole
T46 - 4" Round Hi Visibility Stop/Turn/Tail				Pg 7
T46-AA0A-1	Hi Visibility 4"Round Amber Turn Amber Lens Amp Connector		100	Amp
T46-AA0P-1	Hi Visibility 4" Round Amber Turn Amber Lens Pig Tail		100	Pigtail
T46-AA0T-1	Hi Visibility 4" Round Amber Turn Amber Lens Tri Pole Connector		100	Tri Pole
T46-AC0A-1	Hi Visibility 4" Round Amber Turn Clear Lens Amp Connector		100	Amp
T46-AC0P-1	Hi Visibility 4" Round Amber Turn Clear Lens Pig Tail		100	Pigtail
T46-AC0T-1	Hi Visibility 4" Round Amber Turn Clear Lens Tri Pole Connector		100	Tri Pole
T46-RC0A-1	Hi Visibility 4" Round STT Clear Lens Grommet Mount Amp		100	Amp
T46-RC0T-1	Hi Visibility 4" Round STT Clear Lens Grommet Mount Tri-Pole		100	Tri Pole

Part No.	Part Description	Color	STD Pack	Connector
T46-RCFA-1	Hi Visibility 4" Round STT Clear Lens Flange Mount Amp		100	Amp
T46-RCFT-1	Hi Visibility 4" Round STT Clear Lens Flange Mount Tri-Pole		100	Tri Pole
T46-RR0A-1	Hi Visibility 4" Round STT Red Lens Grommet Mount Amp		100	Amp
T46-RR0T-1	Hi Visibility 4" Round STT Red Lens Grommet Mount Tri-Pole		100	Tri Pole
T46-RRFA-1	Hi Visibility 4" Round STT Red Lens Flange Mount Amp		100	Amp
T46-RRFT-1	Hi Visibility 4" Round STT Red Lens Flange Mount Tri-Pole		100	Tri Pole

T60 - 6" Grommet Mount Oval Stop-Turn-Tail



















































Pg 2

T60-0G00-1	6" Oval Grommet		-	-
T60-AAHA-1	6" Oval Amber Turn Horiz. Grommet Mt Amber Lens Amp Connector		100	Amp
T60-AAHP-1	6" Oval Amber Turn Horiz. Grommet Mnt Amber Lens Pig Tail		140	Pigtail
T60-AAHT-1	6" Oval Amber Turn Horiz. Grommet Mnt Amber Lens 3 Pole		100	Tri Pole
T60-AAVA-1	6" Oval Amber Turn Vertical Grommet Mnt Amber Lens Amp Connector		100	Amp
T60-AAVP-1	6" Oval Amber Turn Vertical Grommet Mnt Amber Lens Pig Tail		140	Pigtail
T60-AAVT-1	6" Oval Amber Turn Vertical Grommet Mnt Amber Lens 3 Pole		100	Tri Pole
T60-ACHA-1	6" Oval Amber Turn Horiz. Grommet Mnt Clear Lens Amp Connector		100	Amp
T60-ACHP-1	6" Oval Amber Turn Horiz. Grommet Mount Clear Lens Pig Tail		140	Pigtail
T60-ACHT-1	6" Oval Amber Turn Horiz. Grommet Mount Clear Lens 3 Pole		100	Tri Pole
T60-ACVA-1	6" Oval Amber Turn Vertical Grommet Mount Clear Lens Amp Connector		100	Amp
T60-ACVP-1	6" Oval Amber Turn Vertical Grommet Mnt Clear Lens Pig Tail		140	Pigtail
T60-ACVT-1	6" Oval Amber Turn Vertical Grommet Mnt Clear Lens 3 Pole		100	Tri Pole
T60-RCHA-1	6" Oval Red STT Horiz. Grommet Mount Clear Lens Amp		100	Amp
T60-RCHP-1	6" Oval Red STT Horiz. Grommet Mount Clear Lens Pig Tail		140	Pigtail
T60-RCHT-1	6" Oval Red STT Horiz. Grommet Mount Clear Lens 3 Pole		100	Tri Pole
T60-RCVA-1	6" Oval Red STT Vertical Grommet Mount Clear Lens Amp		100	Amp
T60-RCVP-1	6" Oval Red STT Vertical Grommet Mount Clear Lens Pig Tail		140	Pigtail
T60-RCVT-1	6" Oval Red STT Vertical Grommet Mount Clear Lens 3 Pole		100	Tri Pole
T60-RRHA-1	6" Oval Red STT Horiz. Grommet Mount Red Lens Amp		100	Amp
T60-RRHB-1	6" Oval Red STT Horiz. Grommet Mount Red Lens w/.180" Bullet		140	0.180" Bullets
T60-RRHP-1	6" Oval Red STT Horiz. Grommet Mount Red Lens Pig Tail		140	Pigtail
T60-RRHT-1	6" Oval Red STT Horiz. Grommet Mount Red Lens 3 Pole		100	Tri Pole
T60-RRVA-1	6" Oval Red STT Vertical Grommet Mount Red Lens Amp		100	Amp
T60-RRVP-1	6" Oval Red STT Vertical Grommet Mount Red Lens Pig Tail		140	Pigtail
T60-RRVT-1	6" Oval Red STT Vertical Grommet Mount Red Lens 3 Pole		100	Tri Pole
T60-WCHP-1	6" Oval White Light Horiz Grommet Mount Clear Lens Pig Tail		140	Pigtail
T60-WCVA-1	6" Oval White Vertical Grommet Mount Clear Lens Amp		100	Amp

T61 - Surface mount Oval Stop-Turn-Tail

Pg 3

T61-0B00-1	6" Oval Surface Mount Trim Ring Black		-	
T61-0C00-1	6" Oval Surface Mount Trim Ring Chrome		-	
T61-0G00-1	6" Oval Surface Mount Gasket		-	
T61-AAHA-1	6" Oval Amber Turn Horiz. Surface Mount Amber Lens Amp		120	Amp

Part No.	Part Description	Color	STD Pack	Connector
T61-AAHP-1	6" Oval Amber Turn Horiz. Surface Mount Amber Lens Pig Tail	 	140	Pigtail
T61-AAHT-1	6" Oval Amber Turn Horiz. Surface Mount Amber Lens 3 Pole	 	120	Tri Pole
T61-AAVA-1	6" Oval Amber Turn Vert. Surface Mount Amber Lens Amp Connector	 	120	Amp
T61-AAVP-1	6" Oval Amber Turn Vertical Surface Mount Amber Lens Pig Tail	 	140	Pigtail
T61-AAVT-1	6" Oval Amber Turn Vertical Surface Mount Amber Lens 3 Pole	 	120	Tri Pole
T61-ACHA-1	6" Oval Amber Turn Horiz. Surface Mount Clear Lens Amp Connector	 	120	Amp
T61-ACHP-1	6" Oval Amber Turn Horiz. Surface Mount Clear Lens Pig Tail	 	140	Pigtail
T61-ACHT-1	6" Oval Amber Turn Horiz. Surface Mount Clear Lens 3 Pole	 	120	Tri Pole
T61-ACVA-1	6" Oval Amber Turn Vert. Surface Mount Clear Lens Amp connector	 	120	Amp
T61-ACVP-1	6" Oval Amber Turn Vertical Surface Mnt Clear Lens Pig Tail	 	140	Pigtail
T61-ACVT-1	6" Oval Amber Turn Vertical Surface Mnt Clear Lens 3 Pole	 	120	Tri Pole
T61-RCHA-1	6" Oval Red STT Horiz. Surface Mount Clear Lens Amp	 	120	Amp
T61-RCHP-1	6" Oval Red STT Horiz. Surface Mount Clear Lens w/Pig-Tail	 	140	Pigtail
T61-RCHT-1	6" Oval Red STT Horiz. Surface Mount Clear Lens 3 Pole	 	120	Tri Pole
T61-RCVA-1	6" Oval Red STT Vertical Surface Mount Clear Lens Amp	 	120	Amp
T61-RCVP-1	6" Oval Red STT Vertical Surface Mount Clear Lens Pig Tail	 	140	Pigtail
T61-RCVT-1	6" Oval Red STT Vertical Surface Mount Clear Lens 3 Pole	 	120	Tri Pole
T61-RRHA-1	6" Oval Red STT Horiz. Surface Mount Red Lens Amp	 	120	Amp
T61-RRHB-1	6" Oval Red STT Horiz Surf Mnt Red Lens Pigtail w/.180" Bullet	 	140	0.180" Bullets
T61-RRHP-1	6" Oval Red STT Horiz. Surface Mount Red Lens w/Pig-Tail	 	140	Pigtail
T61-RRHT-1	6" Oval Red STT Horiz. Surface Mount Red Lens 3 Pole	 	120	Tri Pole
T61-RRVA-1	6" Oval Red STT Vertical Surface Mount Red Lens Amp	 	120	Amp
T61-RRVP-1	6" Oval Red STT Vertical Surface Mount Red Lens Pig Tail	 	140	Pigtail
T61-RRVT-1	6" Oval Red STT Vertical Surface Mount Red Lens 3 Pole	 	120	Tri Pole
T61-WCHP-1	6" Oval White Light Surface Mount Pig Tails	 	140	Pigtail















T62 - Flush Mount Oval Tail

Pg 4

T62-AAHA-1	Amber Flange Mount Horizontal Oval Amber Lens Amp Connector	 	120	Amp
T62-RCHA-1	Red Flange Mount Horizontal Oval Tail Clear Lens Amp Connector	 	120	Amp
T62-RCVA-1	Red Flange Mount Vertical Oval Tail Clear Lens Amp Connector	 	120	Amp
T62-RRHA-1	Red Flange Mount Horizontal Oval Tail Red Lens Amp Connector	 	120	Amp
T62-RRVA-1	Red Flange Mount Vertical Oval Tail Red Lens Amp Connector	 	120	Amp
T62-W0VA-1	Oval Tail Reverse Lamp Flange Vertical Mount Amp Connector	 	120	Amp

T66 - Universal Mount Oval Stop-Turn-Tail

Pg 6

T66-AA0A-1	6" Oval 6 LED Turn Dual Intensity Grommet Mount Amber Lens Amp Con	 	120	Amp
T66-AA0P-1	6" Oval 6 LED Turn Dual Intensity Grommet Mount Amber Lens Pigtail	 	140	Pigtail
T66-AA0T-1	6" Oval 6 LED Turn Dual Intensity Grommet Mount Amber Lens 3 Pole	 	120	Tri Pole
T66-AASA-1	6" Oval 6 LED Turn Dual Intensity Surface Mount Amber Lens Amp Con	 	120	Amp
T66-AASP-1	6" Oval 6 LED Turn Dual Intensity Surface Mount Amber Lens Pigtail	 	140	Pigtail
T66-AAST-1	6" Oval 6 LED Turn Dual Intensity Surface Mount Amber Lens Three Pole	 	120	Tri Pole
T66-AC0A-1	6" Oval 6 LED Turn Dual Intensity Grommet Mount Clear Lens Amp Con	 	120	Amp

Part No.	Part Description	Color	STD Pack	Connector
T66-AC0P-1	6" Oval 6 LED Turn Dual Intensity Grommet Mount Clear Lens Pigtail		140	Pigtail
T66-AC0T-1	6" Oval 6 LED Turn Dual Intensity Grommet Mount Clear Lens T style		120	Tri Pole
T66-RC0A-1	6" Oval 6 LED STT Grommet Mount Clear Lens Amp Con		120	Amp
T66-RC0P-1	6" Oval 6 LED STT Grommet Mount Clear Lens Pigtail		140	Pigtail
T66-RC0T-1	6" Oval STT 6 LED Grommet Mount Clear Lens T Style		120	Tri Pole
T66-RCSP-1	6" Oval 6 LED STT Surface Mount Clear Lens Pigtail		140	Pigtail
T66-RCST-1	6" Oval 6 LED STT Surface Mount Clear Lens Tri Pole		140	Tri Pole
T66-RRST-1	6" Oval 6 LED STT Surface Mount Red Lens Three Pole		120	Tri Pole
T66-RR0A-1	6" Oval STT 6 LED Grommet Mount Red Lens Amp Con		120	Amp
T66-RR0P-1	6" Oval 6 LED STT Grommet Mount Red Lens Pigtail		140	Pigtail
T66-RR0T-1	6" Oval 6 LED STT Grommet Mount Red Lens 3 Pole		120	Tri Pole
T66-RRSP-1	6" Oval 6 LED STT Surface Mount Red Lens Pig Tail		140	Pigtail
T66-WC0T-1	6" Oval 6 LED White Grommet Mount Clear Lens Three Pole		120	Tri Pole
T66-WCRB-1	6" Oval 6 LED White Grommet Mount Clear Lens .180" Bullets		140	0.180" Bullets
T66-WCRP-1	6" Oval Reverse 6 LED White Grommet Mount Clear Lens Pigtail		140	Pigtail
T66-WCRT-1	6" Oval Reverse 6 LED White Grommet Mount Clear Lens 3 Pole		120	Tri Pole
T66-WCSP-1	6" Oval Reverse 6 LED White Surface Mount Clear Lens Pigtail		140	Pigtail
T66-WCST-1	6" Oval Reverse 6 LED White Surface Mount Clear Lens Tri Pole Connector		120	Tri Pole













T70 - Combination Oval Stop-Turn-Tail-Reverse

Pg 9

T70-RW0A-1	6" Oval Stop Tail Turn Reverse Grommet Red Lens 2 Amp Connectors		100	Amp
T70-RW0P-1	6" Oval Stop Tail Turn Reverse Grommet Red Lens 2 Pigtail Connectors		140	Pigtail
T70-RW0T-1	6" Oval Stop Tail Turn Reverse Grommet Red Lens 2 Tri Pole Connectors		100	Tri Pole
T70-RWFA-1	6" Oval Stop Tail Turn Reverse Flange Red Lens 2 Amp Connectors		120	Amp
T70-RWFP-1	6" Oval Stop Tail Turn Reverse Flange Red Lens 2 Pigtail Connectors		140	Pigtail
T70-RWSA-1	6" Oval Stop Tail Turn Reverse Surface Red Lens 2 Amp Connectors		120	Amp
T70-RWSP-1	6" Oval Stop Tail Turn Reverse Surface Red Lens 2 Pigtail Connectors		140	Pigtail
T70-RWST-1	6" Oval Stop Tail Turn Reverse Surface Red Lens 2 Tri Pole Connectors		120	Tri Pole
T70-RC0A-1	6" Oval Stop Tail Turn Reverse Grommet Clear Lens 2 Amp Connectors		100	Amp
T70-RC0P-1	6" Oval Stop Tail Turn Reverse Grommet Clear Lens 2 Pigtail Connectors		140	Pigtail
T70-RC0T-1	6" Oval Stop Tail Turn Reverse Grommet Clear Lens 2 Tri Pole Connectors		100	Tri Pole
T70-RCFA-1	6" Oval Stop Tail Turn Reverse Flange Clear Lens 2 Amp Connectors		120	Amp
T70-RCFP-1	6" Oval Stop Tail Turn Reverse Flange Clear Lens 2 Pigtail Connectors		140	Pigtail
T70-RCSA-1	6" Oval Stop Tail Turn Reverse Surface Clear Lens 2 Amp Connectors		120	Amp
T70-RCSP-1	6" Oval Stop Tail Turn Reverse Surface Clear Lens 2 Pigtail Connectors		140	Pigtail
T70-RCST-1	6" Oval Stop Tail Turn Reverse Surface Clear Lens 2 Tri Pole Connectors		120	Tri Pole

T80 - 8" Multifunction Box Tail Light

Pg 11

Part No.	Part Description	Color	STD Pack	Connector
T80-RRLG-1	8 Function 8" Box Tail Light Left Side Pig Tail w/ Ground Ring		32	Pigtail / Self grounded
T80-RRLP-1	8 Function 8" Box Tail Light Left Side Pig Tail		32	Pigtail
T80-RRRG-1	7 Function 8" Box Tail Light Right Side Pig Tail w/ Ground Ring		32	Pigtail / Self grounded
T80-RRRP-1	7 Function 8" Box Tail Light Right Side Pig Tail		32	Pigtail
T85 - 4" Multifunction Box Tail Light				Pg 10
T85-RRLG-1	8 Function 4" Box Tail Light Left Side Pig Tail w/ Ground Ring		32	Pigtail / Self grounded
T85-RRLP-1	8 Function 4" Box Tail Light Left Side Pig Tail		32	Pigtail
T85-RRRG-1	7 Function 4" Box Tail Light Right Side Pig Tail w/ Ground Ring		32	Pigtail / Self grounded
T85-RRRP-1	7 Function 4" Box Tail Light Right Side Pig Tail		32	Pigtail
T86 - 6" Multifunction Box Tail Light				Pg 10
T86-RRLG-1	8 Function 6" Box Light Left Side Pig Tail w/ Ground Ring		32	Pigtail / Self grounded
T86-RRLP-1	8 Function 6" Box Light Left Side Pig Tail		32	Pigtail
T86-RRRG-1	7 Function 6" Box Light Right Side Pig Tail w/ Ground Ring		32	Pigtail / Self grounded
T86-RRRP-1	7 Function 6" Box Light Right Side Pig Tail		32	Pigtail
Wires & Connectors				Pg 52
S99-0010-1	6" 2-Pole .156" Bullet with #6 GND Lug		–	Male 2 Pole
S99-0035-1	S35 2-Pole Sure-Seal w/.180" Bullet and #6 GND Lug 90 deg.		–	Two Pole (spade)
S99-0A35-1	S35 2-Pole Sure-Seal w/.180" Bullet and 1" #10 GND Lug		–	Two Pole (spade)
S99-1A35-1	S35 2-Pole Sure-Seal 8" Leads		–	Two Pole (spade)
S99-3600-1	2 Pole Connector W/Bullet Ends		–	Two Pole (spade)
S99-3610-1	2 Pole Connector W/Bullet Ends and Grommet		–	Two Pole (spade)
T99-0010-1	12" 3-Pole .156" Bullet w/#6 GND Lug - Straight		–	Tri Pole
T99-0020-1	12" 3-Pole .156" Bullet w/#6 GND Lug - 90 degree		–	Tri Pole
T99-0040-1	Amp - Pigtail Wire Adapter		–	Amp
T99-0050-1	Amp - Tri pole Adapter		–	Amp - Tri Pole
T99-0060-1	3 Pole Style plug with 6" wires		–	Tri Pole