

# PRORENFORT

Le pro de la distribution  
The pro of distribution

Produits marin  
Marine Products

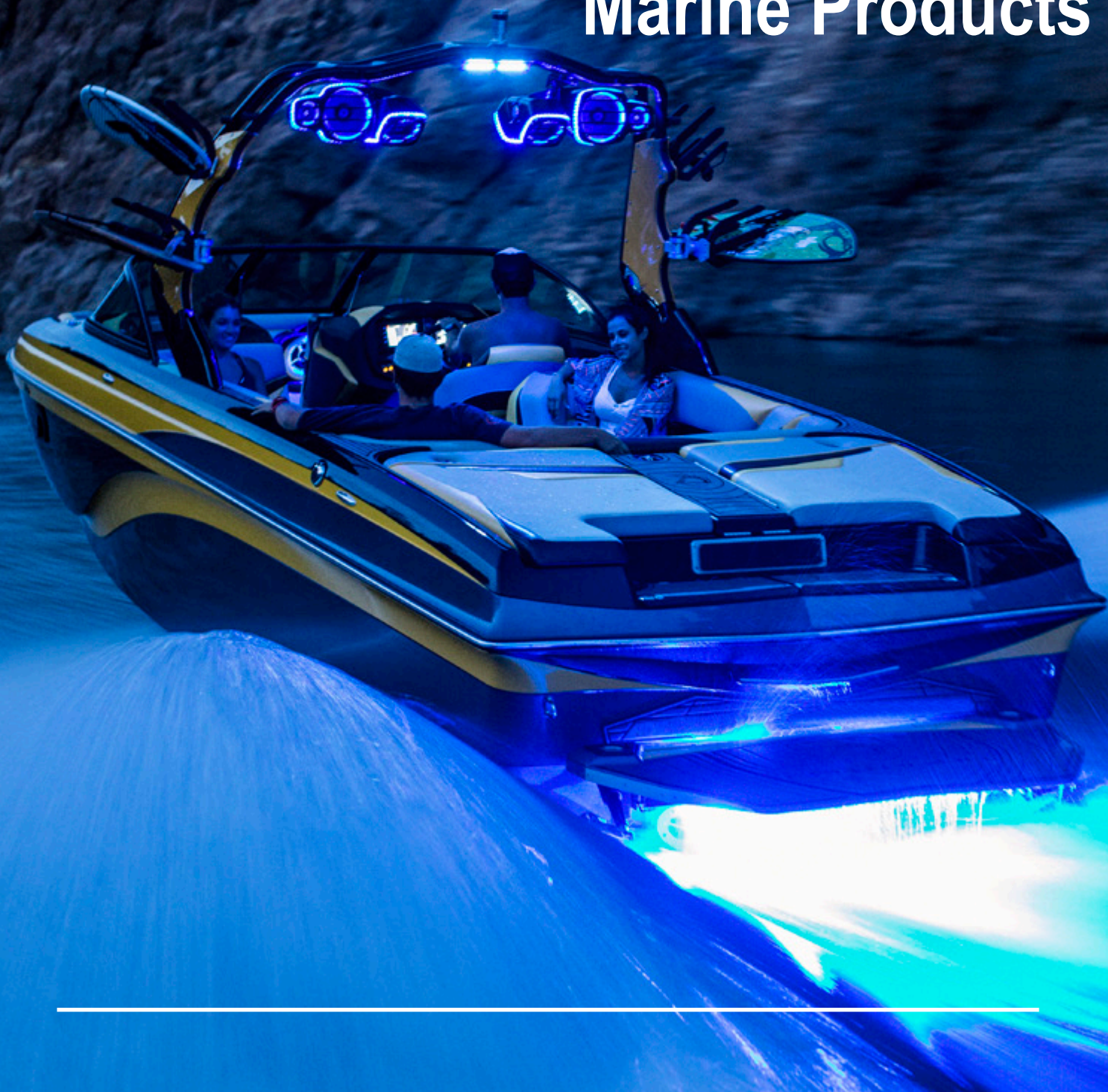



## Table of contents

|   |            |
|---|------------|
| Colored Accent Lighting . . . . .               | pg 2 - 4   |
| Interior Area Lighting . . . . .                | pg 5 - 9   |
| Exterior Area Lighting . . . . .                | pg 10 - 15 |
| Trailer Tail Lights . . . . .                   | pg 16 - 23 |
| Over 80" ID Bars . . . . .                      | pg 24 - 25 |
| License Plate Lighting . . . . .                | pg 26 - 27 |
| Trailer Sidemarkers and Fender Lights . . . . . | pg 28 - 35 |
| Trailer DOT Requirements . . . . .              | pg 36 - 37 |

# Dragon Lights Model D140









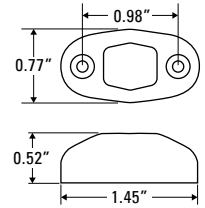









## Features



- Excellent interior accent light
- Guaranteed water proof
- Easy installation – two #4 screws
- 316 stainless steel cover
- Cover also available in black and white powder coat
- Life performance: 50,000 hours



| Part Number | Description                                  | Amps          | Color   | Std Qty   |
|-------------|--|---------------|---|---|
| D14-0B00-1  | Dragon Light Oval Case - Black               |               |   | 50  |
| D14-0S00-1  | Dragon Light Oval Case - SS                  |               |   | 50  |
| D14-0W00-1  | Dragon Light Oval Case - White               |               |   | 50  |
| D14-A000-1  | Dragon Light Oval Body Amber - 9" Wire       | 0.04A - 0.07A |       | 50  |
| D14-B000-1  | Dragon Light Oval Body Blue - 9" Wire        |               |       | 50  |
| D14-D000-1  | Dragon Light Oval Body Deep Red - 9" Wire    |               |       | 50  |
| D14-G000-1  | Dragon Light Oval Body Green - 9" Wire       |               |       | 50  |
| D14-R000-1  | Dragon Light Oval Body Red - 9" Wire         |               |       | 50  |
| D14-U000-1  | Dragon Light Oval Body Ultraviolet - 9" Wire |               | 0.03A - 0.05A   |   |
| D14-W000-1  | Dragon Light Oval Body White - 9" Wire       | 0.04A - 0.07A |     | 50  |
| D14-W00F-1  | Dragon Light Oval Body White Flood - 9" Wire |               |   | 50  |

\*Custom connectors available upon request



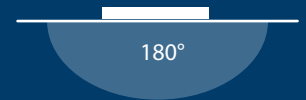





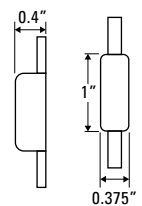

# LED Pod Lighting Model D020



## Features

- Provides an impressive 50 lumens per pod (white)
- Sealed light is vibration and water proof
- Up to 100 lamps per string, spaced 14 inches
- Easily installed with **3M** adhesive tape back of lamp
- Life performance: 50,000 hours



| Part Number | Description                                       | Amps          | Color   | Std Qty       |
|-------------|---|---------------|---|---------------|
| D02-A001-1  | Ladder Light Amber 1 Section - 14" Section Length | 0.06A - 0.08A |   | Made to Order |
| D02-B001-1  | Ladder Light Blue 1 Sections - 14" Section Length | 0.03A - 0.04A |   | Made to Order |
| D02-G001-1  | Ladder Light Green 1 Section - 14" Section Length |               |   | Made to Order |
| D02-R001-1  | Ladder Light Red 1 Section - 14" Section Length   | 0.06A - 0.08A |   | Made to Order |
| D02-W001-1  | Ladder Light White 1 Section - 14" Section Length | 0.07A - 0.09A |   | Made to Order |

\*Ctom connectors available upon request



# Mini Accent Light Model S340

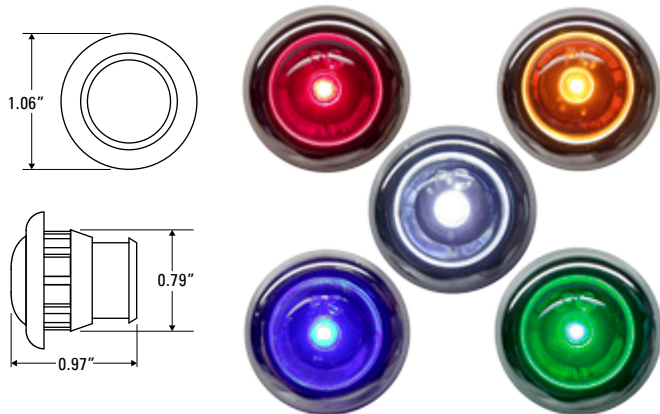

## Features



- Our most popular light
- Completely water proof
- Easily mounts into standard 3/4" hole
- TecSeal Urethane Potting - Guaranteed Circuit Board Protection
- IP68 Rated - Dust and water proof
- Durable impact resistant lens
- 316 stainless steel trim ring available
- Includes chemical resistant TPE grommet

| Part Number | Description                               | Amps          | Color | Std Qty |
|-------------|---|---------------|-------|---------|
| S33-OS00-1  | Stainless Steel Trim Ring for S33 and S34 |               |       | 100     |
| S34-AA00-1  | Amber Mini PC Sidemarker Amber Lens       | 0.07A - 0.09A |       | 100     |
| S34-AC00-1  | Amber Mini PC Sidemarker Clear Lens       | 0.03A - 0.06A |       | 100     |
| S34-BC00-1  | Blue Mini PC Sidemarker Clear Lens        | 0.03A - 0.04A |       | 100     |
| S34-GC00-1  | Green Mini PC Sidemarker Clear Lens       |               |       | 100     |
| S34-RR00-1  | Red Mini PC Sidemarker Red Lens           | 0.07A - 0.09A |       | 100     |
| S34-RC00-1  | Red Mini PC Sidemarker Clear Lens         | 0.06A - 0.08A |       | 100     |
| S34-WC00-1  | White Mini PC Sidemarker Clear Lens       | 0.07A - 0.09A |       | 100     |

\*Custom connectors available upon request



# 3/4" Grommet Mount Accent Light Model E340

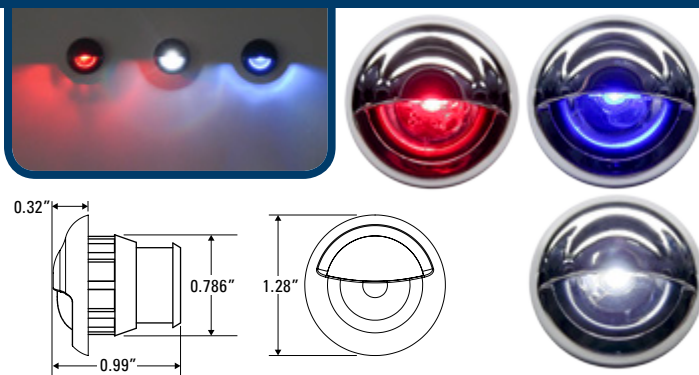

## Features



- Light provides downward accent light
- Perfect for steps or walkways
- Guaranteed water proof
- Easily mounts into a 3/4" hole
- Includes chemical resistant TPE grommet

| Part Number | Description  | Amps          | Color | Std Qty |
|-------------|--|---------------|-------|---------|
| E34-BB00-1  | E34 Step Light Grommet Mounted Blue W/ Black Cover   | 0.02A - 0.04A |       | 10      |
| E34-BC00-1  | E34 Step Light Grommet Mounted Blue W/ Chrome Cover  |               |       | 10      |
| E34-RB00-1  | E34 Step Light Grommet Mounted Red W/ Black Cover    | 0.06A - 0.08A |       | 10      |
| E34-RC00-1  | E34 Step Light Grommet Mounted Red W/ Chrome Cover   |               |       | 10      |
| E34-WB00-1  | E34 Step Light Grommet Mounted White W/ Black Cover  | 0.07A - 0.09A |       | 10      |
| E34-WC00-1  | E34 Step Light Grommet Mounted White W/ Chrome Cover |               |       | 10      |

\*Custom connectors available upon request

# Nylon Nut Mounted Livewell Light Model M900

NEW

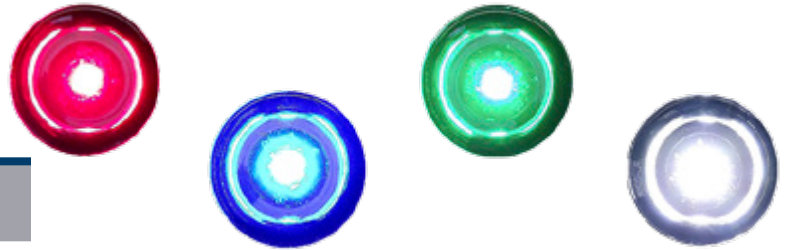







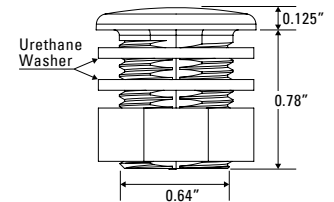
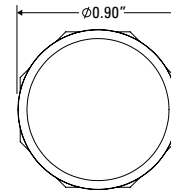

## Features



- Illuminates your livewell for the life of your boat.
- Smooth lens surface, blends into well wall nicely
- Available in four colors, Red, Green, Blue, and White
- Includes (2) chemical resistant TPE gaskets, and one nylon nut
- Vibration and shock proof
- IP68 Rated
- Life performance: 50,000 hours



| Part Number | Description                                   | Amps          | Color   | Std Qty |
|-------------|---|---------------|---|---------|
| M90-BC00-1  | Live Well Light, Blue, TPU Gasket, Nylon Nut  | 0.03A - 0.04A |   | 50      |
| M90-GC00-1  | Live Well Light, Green, TPU Gasket, Nylon Nut |               |   | 50      |
| M90-RC00-1  | Live Well Light, Red, TPU Gasket, Nylon Nut   | 0.06A - 0.08A |   | 50      |
| M90-WC00-1  | Live Well Light, White, TPU Gasket, Nylon Nut | 0.07A - 0.09A |   | 50      |

\*Custom connectors available upon request

# Nylon Nut Mounted Accent Light Model M900

NEW

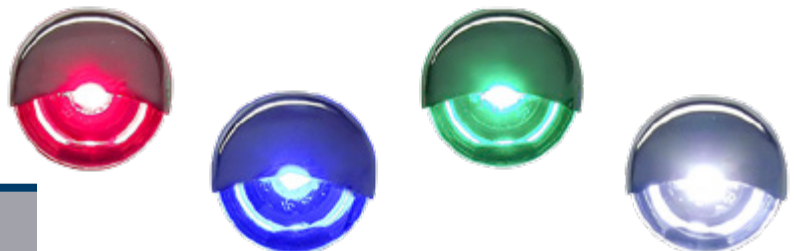







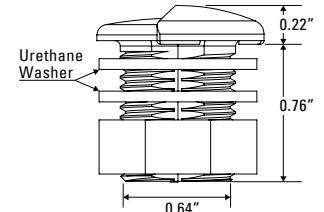
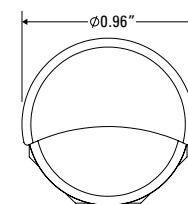

## Features



- Completely waterproof light, perfect for illuminating steps or walk ways
- Easy installation with threaded nylon nut
- Includes two chemical resistant TPE gaskets
- Comes with our corrosion resistant 316 SS polished cover
- IP68 Rated – water & dust proof
- Life performance: 50,000 hours



| Part Number | Description                                | Amps          | Color   | Std Qty |
|-------------|--|---------------|---|---------|
| M90-BS00-1  | Interior Accent Light, Blue LED, SS Cover  | 0.03A - 0.04A |   | 50      |
| M90-GS00-1  | Interior Accent Light, Green LED, SS Cover |               |   | 50      |
| M90-RS00-1  | Interior Accent Light, Red LED, SS Cover   | 0.06A - 0.08A |   | 50      |
| M90-WS00-1  | Interior Accent Light, White LED, SS Cover | 0.07A - 0.09A |   | 50      |

\*Custom connectors available upon request

180°

# Orion 6" LED Dome Light Model E200



\* White/red combo model

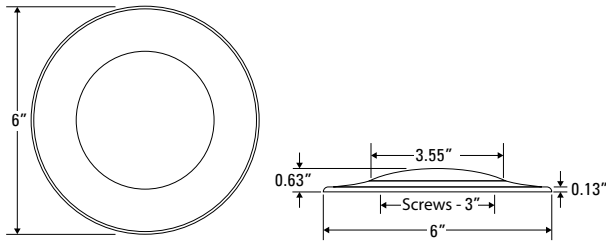

## Features

- Ultra thin surface mount light
- Easy installation with two screws hidden under lens
- High performance - 720 lumens
- Moisture resistant
- Available in bright or satin finished light body
- Night Vision – red/white LED combination also available

| Part Number | Description  | Amps                    | Color   | Std Qty |
|-------------|--|-------------------------|---|---------|
| E20-LA00-1  | 6" Interior Light Neutral White - Satin Trim Ring          | 0.50A - 0.70A           | <input type="checkbox"/> <input type="checkbox"/> | 5       |
| E20-LC00-1  | 6" Interior Light Neutral White - Chrome Trim Ring         |                         | <input type="checkbox"/> <input type="checkbox"/> | 5       |
| E20-WC00-1  | 6" Interior Light Cool White - Chrome Trim Ring            |                         | <input type="checkbox"/> <input type="checkbox"/> | 5       |
| E20-LA0R-1  | 6" Interior Light Neutral White/Red - Satin Trim Ring      | +0.32A - 0.44A<br>(red) | <input type="checkbox"/> <input type="checkbox"/> | 5       |
| E20-LC0R-1  | 6" Interior Light Neutral White/Red - Chrome Trim Ring     |                         | <input type="checkbox"/> <input type="checkbox"/> | 5       |
| E20-WC0R-1  | 6" Interior Light Cool White/Red Combo - Chrome Trim Ring  |                         | <input type="checkbox"/> <input type="checkbox"/> | 5       |
| E20-WCB0-1  | 6" Interior Light Cool White/Blue Combo - Chrome Trim Ring | +0.55A - 0.74A (blue)   | <input type="checkbox"/> <input type="checkbox"/> | 5       |

\*Custom connectors available upon request



# LED Strip Lighting Model E410

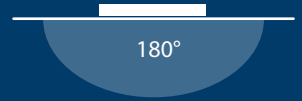

## Features

- Produces 100 lumens per 4.5" section (white)
- Available in 4.5" increments up to 16.5'
- Ultra thin 3/16" strips surface mounts easily in tight spaces
- High flexibility conforms to irregular surfaces
- Easily installed with **3M** adhesive tape back
- Life performance: 50,000 hours
- Contact your salesperson for ordering information

\*Interior and covered applications only

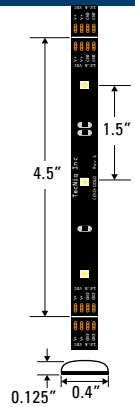

| Part Number | Description                                       | Amps                | Color | Std Qty       |
|-------------|---|---------------------|-------|---------------|
| E41-000V-1  | 2 wire termination                                |                     |       |               |
| E41-304X-1  | Flexible LED Light RGB 18" - Dual 4 -Wire Pigtail | Varies              |       | -             |
| E41-A010-1  | Flexible LED Light Amber 4.5" - No Wire           | 0.58A - 0.70A / 6ft |       | Made to Order |
| E41-B010-1  | Flexible LED Light Blue 4.5" - No Wire            | 0.41A - 0.50A / 6ft |       | Made to Order |
| E41-G010-1  | Flexible LED Light Green 4.5" - No Wire           | 0.41A - 0.50A / 6ft |       | Made to Order |
| E41-R010-1  | Flexible LED Light Red 4.5" - No Wire             | 0.58A - 0.70A / 6ft |       | Made to Order |
| E41-W010-1  | Flexible LED Light White 4.5" - No Wire           | 0.75A - 0.91A / 6ft |       | Made to Order |

E41 Available in custom lengths from 4.5" – 16.5 ft (4.5" increments)

\*Custom connectors available upon request

# LED Waterproof Strip Lighting Model E440

**NEW**

## Features

- Produces 100 lumens per 4.5" section (white)
- Available in 4.5" increments up to 16.5'
- Ultra thin 3/16" strips surface mounts easily in tight spaces
- High flexibility conforms to irregular surfaces
- Easily installed with **3M** adhesive tape back
- Life performance: 50,000 hours
- Contact your salesperson for ordering information

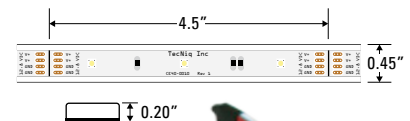

| Part Number | Description                                       | Amps                | Color | Std Qty       |
|-------------|---|---------------------|-------|---------------|
| E44-000V-1  | 2 wire termination                                |                     |       |               |
| E44-304X-1  | Flexible LED Light RGB 18" - Dual 4 -Wire Pigtail | Varies              |       | -             |
| E44-A010-1  | Flexible LED Light Amber 4.5" - No Wire           | 0.58A - 0.70A / 6ft |       | Made to Order |
| E44-B010-1  | Flexible LED Light Blue 4.5" - No Wire            | 0.41A - 0.50A / 6ft |       | Made to Order |
| E44-G010-1  | Flexible LED Light Green 4.5" - No Wire           | 0.41A - 0.50A / 6ft |       | Made to Order |
| E44-R010-1  | Flexible LED Light Red 4.5" - No Wire             | 0.58A - 0.70A / 6ft |       | Made to Order |
| E44-W010-1  | Flexible LED Light White 4.5" - No Wire           | 0.75A - 0.91A / 6ft |       | Made to Order |

E44 Available in custom lengths from 4.5" – 16.5 ft (4.5" increments)

\*Custom connectors available upon request

# Surface-Mounted Interior Light Model E160

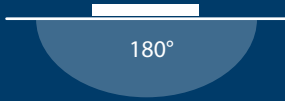

\* Available with or without integrated power switch



## Features



- Lamp features six high efficiency LEDs, providing over 300 lumens
- Sleek and stylish surface mount design
- Installs with just 4 screws hidden behind lens
- White or black base available

| Part Number | Description  | Amps          | Color  | Std Qty |
|-------------|--|---------------|--|---------|
| E16-LW00-1  | E16 Interior SM Neutral White Oval Light White Base          | 0.18A - 0.23A | <input type="checkbox"/> <input type="radio"/> | 20      |
| E16-LWS0-1  | E16 Interior SM Neutral White Oval Light White Base w/Switch |               | <input type="checkbox"/> <input type="radio"/> | 20      |
| E16-LB00-1  | E16 Interior SM Neutral White Oval Light Black Base          |               | <input type="checkbox"/> <input type="radio"/> | 20      |
| E16-LBS0-1  | E16 Interior SM Neutral White Oval Light Black Base w/Switch |               | <input type="checkbox"/> <input type="radio"/> | 20      |
| E16-WW00-1  | E16 Interior SM Cool White Oval Light White Base             |               | <input type="checkbox"/> <input type="radio"/> | 20      |
| E16-WWS0-1  | E16 Interior SM Cool White Oval Light White Base w/Switch    |               | <input type="checkbox"/> <input type="radio"/> | 20      |
| E16-WB00-1  | E16 Interior SM Cool White Oval Light Black Base             |               | <input type="checkbox"/> <input type="radio"/> | 20      |
| E16-WBS0-1  | E16 Interior SM Cool White Oval Light Black Base w/Switch    |               | <input type="checkbox"/> <input type="radio"/> | 20      |

\*Custom connectors available upon request

# Surface-Mounted Interior Light Model E180

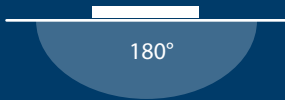

\* Available with or without integrated power switch

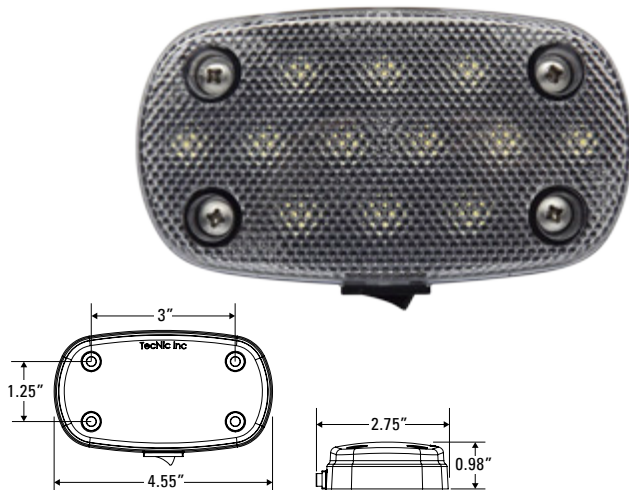

## Features

- Surface mounted for ease of installation – requires one 3/8" wire hole
- Vibration proof, moisture-resistant design
- Reliable performance over 50,000 hours
- Lamp output of 800 lumens
- Excellent optic quality and impact resistance

| Part Number | Description   | Amps          | Color  | Std Qty |
|-------------|---|---------------|--|---------|
| E18-LC00-1  | Surface mount 4.5"x2.5" Neutral White 12 LED Dome light           | 0.54A - 0.66A | <input type="checkbox"/> <input type="radio"/> | 10      |
| E18-LCS0-1  | Surface mount 4.5"x2.5" Neutral White 12 LED Dome light w/ Switch |               | <input type="checkbox"/> <input type="radio"/> | 10      |
| E18-WC00-1  | Surface mount 4.5"x2.5" Cool White 12 LED Dome light              |               | <input type="checkbox"/> <input type="radio"/> | 10      |
| E18-WCS0-1  | Surface mount 4.5"x2.5" Cool White 12 LED Dome light w/ Switch    |               | <input type="checkbox"/> <input type="radio"/> | 10      |

\*Custom connectors available upon request



# Spring Mounted Dome Light Models E250/E260

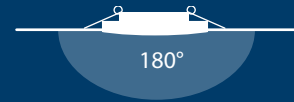

\* Available in 3" Model (E25)  
and 4.5" Model (E26)

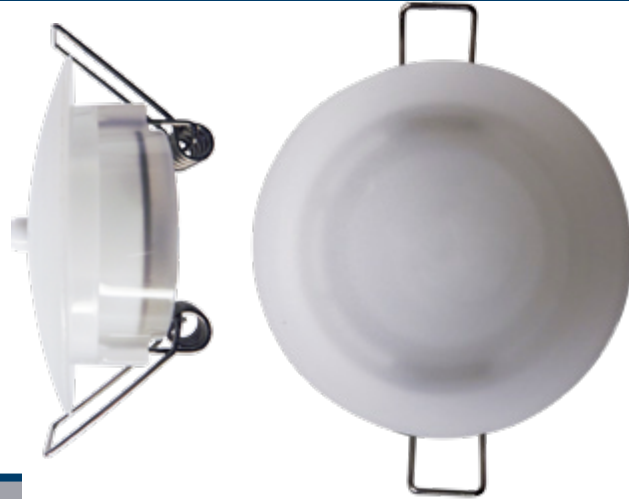

## Features

- New spring mounted design comes in 3" and 4.5" sizes
- Moisture resistant and vibration proof
- Bright: 150 lumens (3.0" model)  
300 lumens (4.5" model)  
460 lumens (4.5" premium model)
- Features diffused lens, clean low profile appearance
- Available with or without ON/OFF push button switch
- Reliable performance over 50,000 hours

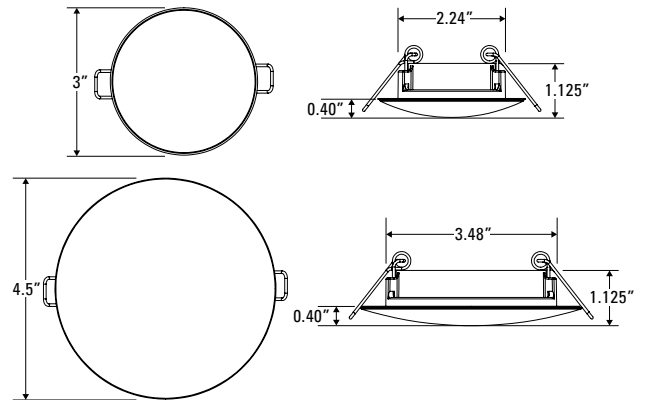

| Part Number | Description   | Amps          | Color   | Std Qty |
|-------------|---|---------------|---|---------|
| E25-L000-1  | 3" Spring Mounted Dome Light, Neutral White                     | 0.13A - 0.15A | <input type="checkbox"/> <input type="checkbox"/> | 10      |
| E25-L0S0-1  | 3" Spring Mounted Dome Light, Neutral White, w/Switch           |               | <input type="checkbox"/> <input type="checkbox"/> | 10      |
| E25-W000-1  | 3" Spring Mounted Dome Light, Cool White                        |               | <input type="checkbox"/> <input type="checkbox"/> | 10      |
| E25-W0S0-1  | 3" Spring Mounted Dome Light, Cool White, w/Switch              |               | <input type="checkbox"/> <input type="checkbox"/> | 10      |
| E26-L000-1  | 4.5" Spring Mounted Dome Light, Neutral White                   | 0.25A - 0.31A | <input type="checkbox"/> <input type="checkbox"/> | 10      |
| E26-L0S0-1  | 4.5" Spring Mounted Dome Light, Neutral White, w/Switch         |               | <input type="checkbox"/> <input type="checkbox"/> | 10      |
| E26-W000-1  | 4.5" Spring Mounted Dome Light, Cool White                      |               | <input type="checkbox"/> <input type="checkbox"/> | 10      |
| E26-W0S0-1  | 4.5" Spring Mounted Dome Light, Cool White, w/Switch            |               | <input type="checkbox"/> <input type="checkbox"/> | 10      |
| E26-LP00-1  | 4.5" Spring Mounted Premium Dome Light, Neutral White           | 0.38A - 0.46A | <input type="checkbox"/> <input type="checkbox"/> | 10      |
| E26-LPS0-1  | 4.5" Spring Mounted Premium Dome Light, Neutral White, w/Switch |               | <input type="checkbox"/> <input type="checkbox"/> | 10      |
| E26-WP00-1  | 4.5" Spring Mounted Premium Dome Light, Cool White              |               | <input type="checkbox"/> <input type="checkbox"/> | 10      |
| E26-WPS0-1  | 4.5" Spring Mounted Premium Dome Light, Cool White, w/Switch    |               | <input type="checkbox"/> <input type="checkbox"/> | 10      |

\*Custom connectors available upon request



# Surface Mounted Dome Light Models E270/E280



\*Available in 3" Model (E27) and 4.5" Model (E28)

## Features

- New surface mounted dome light - easy installation, requires 3/8" wire hole
- Moisture resistant and vibration proof
- 4.5" Premium model available
- Bright: 175 lumens (3.0" model)  
350 lumens (4.5" model)  
525 lumens (4.5" premium model)
- 4.5" model available with or without ON/OFF push button switch
- Three mounting screws concealed by trim ring.
- Reliable performance over 50,000 hours

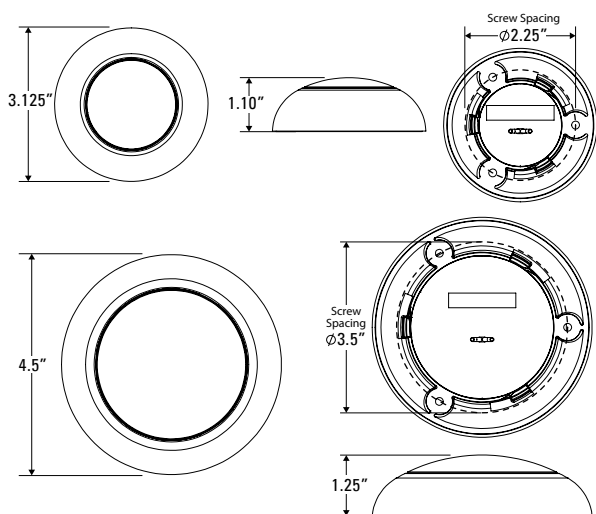

| Part Number | Description   | Amps          | Color   | Std Qty |
|-------------|---|---------------|---|---------|
| E27-L000-1  | 3" Surface Mounted Dome Light, Neutral White                      | 0.13A - 0.15A | <input type="checkbox"/> <input type="checkbox"/> | 10      |
| E27-W000-1  | 3" Surface Mounted Dome Light, Cool White                         |               | <input type="checkbox"/> <input type="checkbox"/> | 10      |
| E28-L000-1  | 4.5" Surface Mounted Dome Light, Neutral White                    | 0.25A - 0.31A | <input type="checkbox"/> <input type="checkbox"/> | 10      |
| E28-L0S0-1  | 4.5" Surface Mounted Dome Light, Neutral White, w/Switch          |               | <input type="checkbox"/> <input type="checkbox"/> | 10      |
| E28-W000-1  | 4.5" Surface Mounted Dome Light, Cool White                       |               | <input type="checkbox"/> <input type="checkbox"/> | 10      |
| E28-W0S0-1  | 4.5" Surface Mounted Dome Light, Cool White, w/Switch             | 0.38A - 0.46A | <input type="checkbox"/> <input type="checkbox"/> | 10      |
| E28-LP00-1  | 4.5" Surface Mounted Premium Dome Light, Neutral White            |               | <input type="checkbox"/> <input type="checkbox"/> | 10      |
| E28-LPS0-1  | 4.5" Surface Mounted Premium Dome Light, Neutral White, w/Switch  |               | <input type="checkbox"/> <input type="checkbox"/> | 10      |
| E28-LPW00-1 | 4.5" Surface Mounted Premium Dome Light, Neutral White White Trim |               | <input type="checkbox"/> <input type="checkbox"/> | 10      |
| E28-WP00-1  | 4.5" Surface Mounted Premium Dome Light, Cool White               |               | <input type="checkbox"/> <input type="checkbox"/> | 10      |
| E28-WPS0-1  | 4.5" Surface Mounted Premium Dome Light, Cool White, w/Switch     |               | <input type="checkbox"/> <input type="checkbox"/> | 10      |

\*Custom connectors available upon request

# All-Round Navigation Light Model M100



\*360° light output exceeds 2 nautical miles

## Features



- Great looking light, designed to provide years of safe boating
- Twist-lock base provides easy installation and hidden fasteners
- TecSeal Urethane Potting - Guaranteed Circuit Board Protection
- Excellent UV Resistance
- Meets ABYC A-16 and USCG 2NM
- 360 degree visibility
- 100mA power draw
- IP68 Rated – water & dust proof
- Includes TPE mounting gasket

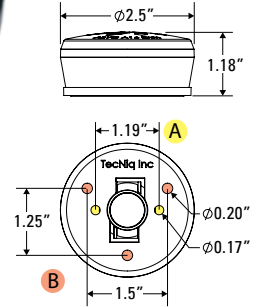

\*Two different mounting screw patterns (A & B)

| Part Number | Description  | Amps          | Color   | Std Qty |
|-------------|--|---------------|---|---------|
| M10-WB00-1  | Waketower All-Round Navigation Light, White LED, 2NM | 0.09A - 0.11A | <input type="checkbox"/> <input type="checkbox"/> | 12      |

\*Custom connectors available upon request

# Surface Mount Area Light Model E050



\*White Cover

## Features



- Integrated On/Off Switch
- Available with 316 stainless steel or high-impact molded in color covers
- Great appearance with hidden fasteners
- Provides 220 lumens of brightness
- Sealed light is vibration and water proof
- Can be mounted on flat or 1" round bar surfaces (w/ available adapter)

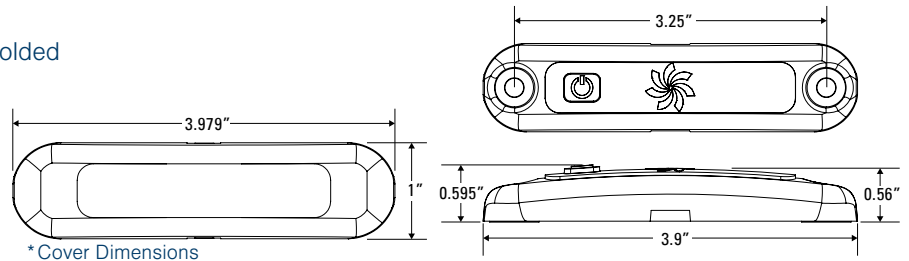

\*Cover Dimensions

| Part Number | Description   | Amps          | Color   | Std Qty |
|-------------|---|---------------|---|---------|
| E05-WSS0-1  | Interior Area Light, Surface Mt.,White LED, SS Cover    | 0.13A - 0.18A | <input type="checkbox"/> <input type="checkbox"/> | 10      |
| E05-WBS0-1  | Interior Area Light, Surface Mt.,White LED, Black Cover |               | <input type="checkbox"/> <input type="checkbox"/> | 10      |
| E05-WWS0-1  | Interior Area Light, Surface Mt.,White LED, White Cover |               | <input type="checkbox"/> <input type="checkbox"/> | 10      |
| E05-0B00-1  | Interior Area Light - 1" Round Bar Mt. Adapter          |               |   |         |

\*Custom connectors available upon request

# Water Dragon Underwater Lighting Model M500



\*M51 standard model

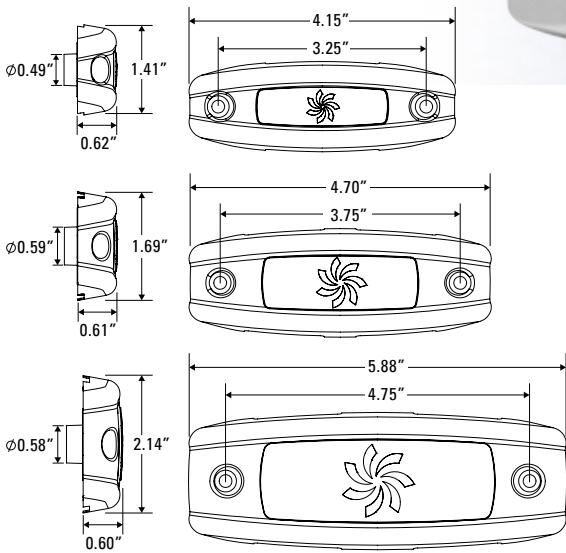

## Features



- The brightest surface mounted under water lights available
- 3 LED Model - 375 lumens each
- 3 LED Model - 1500 lumens each
- 6 LED Model - 2700 lumens each
- 12 Led Model - 5500 lumens each
- Available in three vibrant colors, White, Blue & Green
- Includes 316 polished stainless steel covers
- Anodized die-cast aluminum body
- Thermal overheat protection
- TecSeal Urethane Potting - Guaranteed Circuit Board Protection
- Surface mount design is a snap to install, no large holes to seal

| Part Number | Description  | Amps          | Color  | Std Qty |
|-------------|--|---------------|--|---------|
| M50-WS03-1  | Water Dragon Underwater Light, White, 3 LED, 1500 Lumens         | 1.08A - 1.32A | <input type="checkbox"/> <input type="radio"/> | 10      |
| M50-BS03-1  | Water Dragon Underwater Light, Blue, 3 LED                       | 0.6A - 0.73A  | <input type="checkbox"/> <input type="radio"/> | 10      |
| M50-GS03-1  | Water Dragon Underwater Light, Green, 3 LED                      |               | <input type="checkbox"/> <input type="radio"/> | 10      |
| M50-WS06-1  | Water Dragon Underwater Light, White, 6 LED, 2700 Lumens         | 1.98A - 2.42A | <input type="checkbox"/> <input type="radio"/> | 10      |
| M50-BS06-1  | Water Dragon Underwater Light, Blue, 6 LED                       | 1.13A - 1.38A | <input type="checkbox"/> <input type="radio"/> | 10      |
| M50-GS06-1  | Water Dragon Underwater Light, Green, 6 LED                      |               | <input type="checkbox"/> <input type="radio"/> | 10      |
| M50-WS12-1  | Water Dragon Underwater Light, White, 12 LED, 5500 Lumens        | 3.96A - 4.84A | <input type="checkbox"/> <input type="radio"/> | 10      |
| M50-BS12-1  | Water Dragon Underwater Light, Blue, 12 LED                      | 2.25A - 2.75A | <input type="checkbox"/> <input type="radio"/> | 10      |
| M50-GS12-1  | Water Dragon Underwater Light, Green, 12 LED                     |               | <input type="checkbox"/> <input type="radio"/> | 10      |
| M51-WB03-1  | Water Dragon Standard Underwater Light, White, 3 LED, 375 lumens | 0.27A - 0.33A | <input type="checkbox"/> <input type="radio"/> | 10      |
| M51-BB03-1  | Water Dragon Standard Underwater Light, Blue, 3 LED              |               | <input type="checkbox"/> <input type="radio"/> | 10      |
| M51-GB03-1  | Water Dragon Standard Underwater Light, Green, 3 LED             |               | <input type="checkbox"/> <input type="radio"/> | 10      |

\*Custom connectors available upon request

# Flush Mount Docking Light Model E600

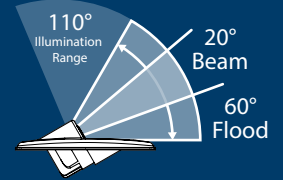

## Features

- Combines great appearance with powerful performance of 2000 lumens each
- Waterproof design, made with our TecSeal Urethane potting
- Anodized cast aluminum heatsink
- 316 Stainless steel cover
- Form fitting TPE gasket to protect the boat finish

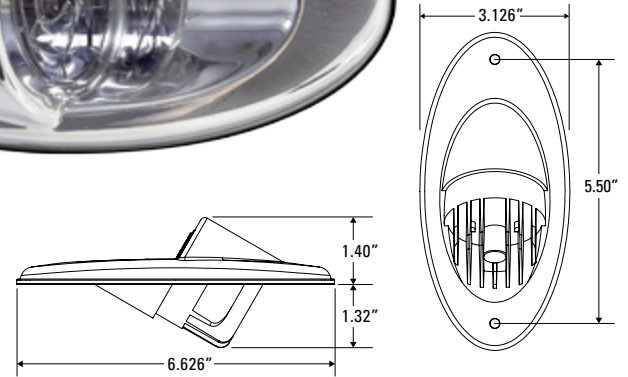

| Part Number | Description                            | Amps          | Color  | Std Qty |
|-------------|--|---------------|--|---------|
| E60-WS20-1  | Recessed Mount LED Docking Light, Pair | 1.25A - 1.75A | <input type="checkbox"/> <input type="radio"/> | 6       |

\*Custom connectors available upon request

# Surface Mount Docking Light Model E610

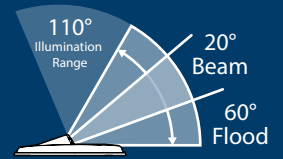

## Features

- Surface mount design is perfect for pontoons and fishing boats
- 1400 Lumen output per light
- Waterproof design, made with our TecSeal Urethane potting
- Anodized cast aluminum heatsink
- 316 Stainless steel cover
- Form fitting TPE gasket to protect the boat finish
- Excellent forward to side of boat illumination

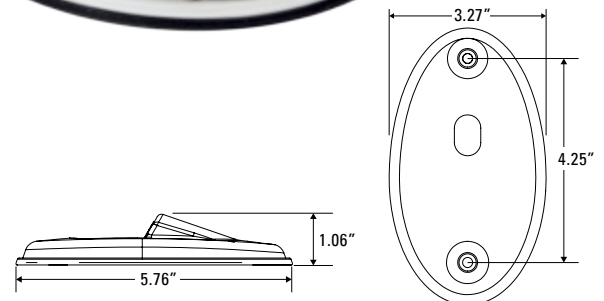

| Part Number | Description                           | Amps          | Color  | Std Qty |
|-------------|---------------------------------------|---------------|--|---------|
| E61-WS00-1  | Surface Mount LED Docking Light, Pair | 0.85A - 1.15A | <input type="checkbox"/> <input type="radio"/> | 6       |

\*Custom connectors available upon request

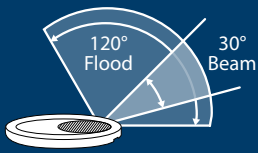

# LED Spot/Flood Light Model E960



## Features

- Surface mount design increases your mounting options and eliminates large oval holes in your hull
- Produces 900 lumens per light
- 316 Stainless Steel Covers
- Waterproof design, made with our TecSeal Urethane potting
- Anodized, die-cast, marine-grade, aluminum body
- Primary spot output is 30° from mounting surface
- Secondary rectangular flood output used for area illumination

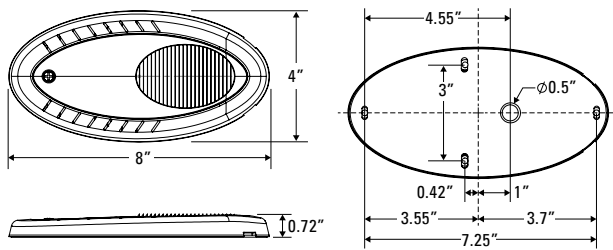

| Part Number | Description                | Amps          | Color   | Std Qty |
|-------------|----------------------------|---------------|---|---------|
| E96-WS00-1  | Docking Light TecNiq, Pair | 0.45A - 0.55A | <input type="checkbox"/> <input type="checkbox"/> | 12      |

\*Custom connectors available upon request

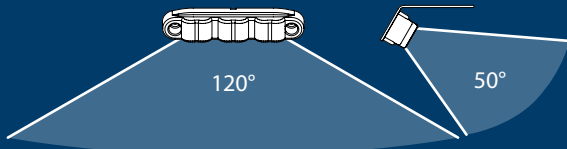

# 6.5" LED Floodlight Model E100

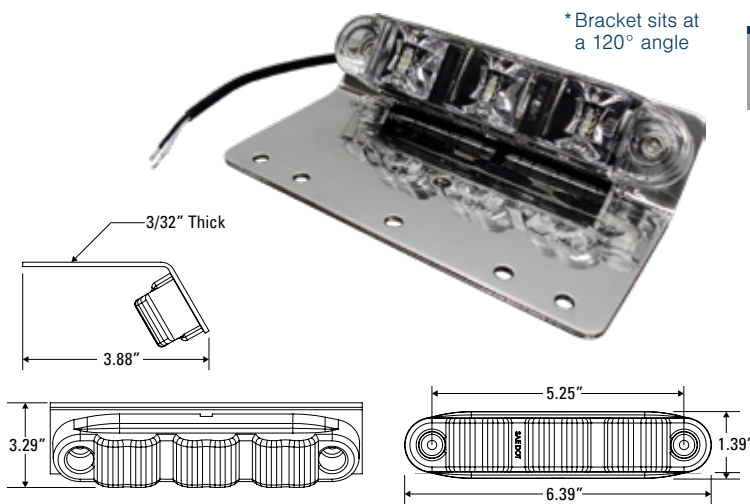

## Features



- Extra wide area of illumination (120° x 50°) covers many applications: task lighting, load lamp, ground lighting, panel lighting, and more
- TecSeal Urethane Potting - Guaranteed Circuit Board Protection
- Waterproof light that is immune to vibration
- Reliable performance over 50,000 hours
- Powerful multi-chip LEDs create 675 lumens
- Durable construction that can withstand the harshest conditions
- Available with or without the stainless steel mounting bracket

| Part Number | Description                                | Amps          | Color   | Std Qty |
|-------------|--|---------------|---|---------|
| E10-W000-1  | EV Ground/Pump Panel Light                 | 0.36A - 0.44A | <input type="checkbox"/> <input type="checkbox"/> | 10      |
| E10-WS00-1  | EV Ground/Pump Panel Light with SS Bracket |               | <input type="checkbox"/> <input type="checkbox"/> | 10      |

\*Custom connectors available upon request

# Flush Mounted Spreader Light Model P100

NEW

## Features



- Designed for the most demanding task illumination applications, in the most extreme environments
- Vibration resistant and 100% water proof
- Built with anodized and white powder coated aluminum bodies with impact-resistant polycarbonate flood projection lenses for exceptional durability
- Available with four high-performance white LEDs, or two white and two night-vision friendly red.
- Proprietary thermal management provides powerful performance in a small package
- Operating voltage range of 9 – 30 VDC
- Completely waterproof and sealed to IP68 standards.

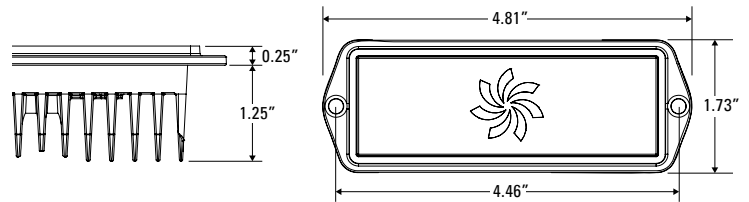

| Part Number | Description  | Lumens      | Amps               | Color   | Std Qty |
|-------------|--|-------------|--------------------|---|---------|
| P10-WWFP-1  | Spreader Light, White LED, White Finish, Pigtail Wires       | 1300 Lumens | 1.08A - 1.32A      | <input type="checkbox"/> <input type="radio"/>            | 2       |
| P10-WRFP-1  | Spreader Light, White & Red LED, White Finish, Pigtail Wires | 700 Lumens  | 0.6A<br>+0.15A red | <input checked="" type="checkbox"/> <input type="radio"/> | 2       |

\*Custom connectors available upon request

# Surface Mounted Spreader Light Model P110

NEW

## Features



- Designed for the most demanding task illumination applications, in the most extreme environments
- Vibration resistant and 100% water proof
- Built with anodized and white powder coated aluminum bodies with impact-resistant polycarbonate flood projection lenses for exceptional durability
- Available with four high-performance white LEDs, or two white and two night-vision friendly red.
- Proprietary thermal management provides powerful performance in a small package
- Operating voltage range of 9 – 30 VDC
- Completely waterproof and sealed to IP68 standards.
- Stainless Steel mounting hardware included

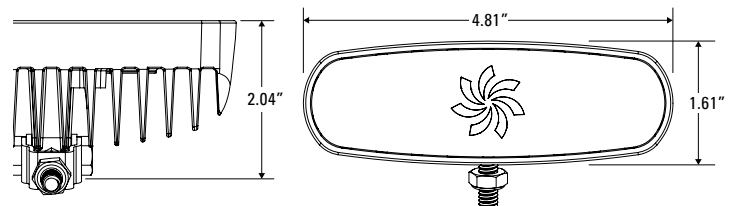

| Part Number | Description  | Lumens      | Amps              | Color   | Std Qty |
|-------------|--|-------------|-------------------|---|---------|
| P11-WWFP-1  | Spreader Light, White LED, White Finish, Pigtail Wires       | 1450 Lumens | 1.44A - 1.76A     | <input type="checkbox"/> <input type="radio"/>            | 2       |
| P11-WRFP-1  | Spreader Light, White & Red LED, White Finish, Pigtail Wires | 825 Lumens  | 0.8A<br>+0.3A red | <input checked="" type="checkbox"/> <input type="radio"/> | 2       |

\*Custom connectors available upon request

# SteelHead Heavy Duty Work Lights Model P020/P040/P060

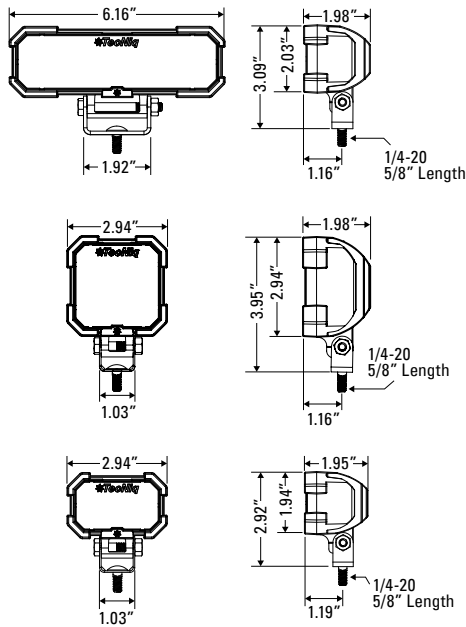
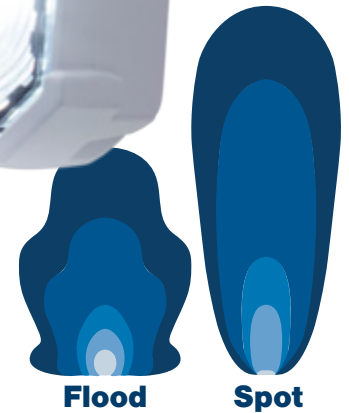

## Features



- Designed for the most demanding task illumination applications, in the most extreme environments
- Vibration resistant and 100% water proof
- Models include Flood or Spot light projection
- Available in Black or White Heavy Duty Powder Coating
- Proprietary thermal management provides powerful performance in a small package
- Operating voltage range of 10 – 30 VDC
- Guaranteed water proof
- Reliable performance over 50,000 hours
- Stainless Steel mounting hardware included

| Part Number | Description   | Lumens      | Amps          | Color        | Std Qty      |   |
|-------------|---|-------------|---------------|--------------|--------------|---|
| P02-WBSP-1  | SteelHead Spot Lamp 2 LED Black Finish Pigtail wires  | 750 Lumens  | 0.39A - 0.47A | Black Finish | 4            |   |
| P02-WBFP-1  | SteelHead Flood Lamp 2 LED Black Finish Pigtail wires |             |               |              | 4            |   |
| P04-WBSP-1  | SteelHead Spot Lamp 4 LED Black Finish Pigtail wires  | 1100 Lumens | 0.50A - 0.62A |              | 2            |   |
| P04-WBFP-1  | SteelHead Flood Lamp 4 LED Black Finish Pigtail wires |             |               |              | 2            |   |
| P06-WBSP-1  | SteelHead Spot Lamp 6 LED Black Finish Pigtail wires  | 1900 Lumens | 1.15A - 1.41A | White Finish | 2            |   |
| P06-WBFP-1  | SteelHead Flood Lamp 6 LED Black Finish Pigtail wires |             |               |              | 2            |   |
| P02-WWSP-1  | SteelHead Spot Lamp 2 LED White Finish Pigtail wires  | 750 Lumens  | 0.39A - 0.47A |              | White Finish | 4 |
| P02-WWFP-1  | SteelHead Flood Lamp 2 LED White Finish Pigtail wires |             |               |              |              | 4 |
| P04-WWSP-1  | SteelHead Spot Lamp 4 LED White Finish Pigtail wires  | 1100 Lumens | 0.50A - 0.62A |              |              | 2 |
| P04-WWFP-1  | SteelHead Flood Lamp 4 LED White Finish Pigtail wires |             |               |              |              | 2 |
| P06-WWSP-1  | SteelHead Spot Lamp 6 LED White Finish Pigtail wires  | 1900 Lumens | 1.15A - 1.41A | 2            |              |   |
| P06-WWFP-1  | SteelHead Flood Lamp 6 LED White Finish Pigtail wires |             |               | 2            |              |   |

\*Custom connectors available upon request



# 6" Oval LED Stop/Tail/Turn Model T660

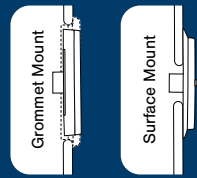

\* Can be mounted at any angle



\* Surface mount with chrome trim



## Features



- Smooth surface, great looking Stop/Tail/Turn Light
- Durable impact resistant lens
- Fit all industry standard 6" oval applications
- Available in grommet, surface, or flange mount
- Can be mounted horizontal, vertical, or at any angle
- TecSeal Urethane Potting - Guaranteed Circuit Board Protection
- Excellent UV Resistance - Automotive exterior lighting grade polycarbonate
- IP68 Rated - Dust and water proof with hermetic seal
- Meets all FMVSS 108 requirements for wide and narrow vehicles
- Reliable performance over 100,000 hours

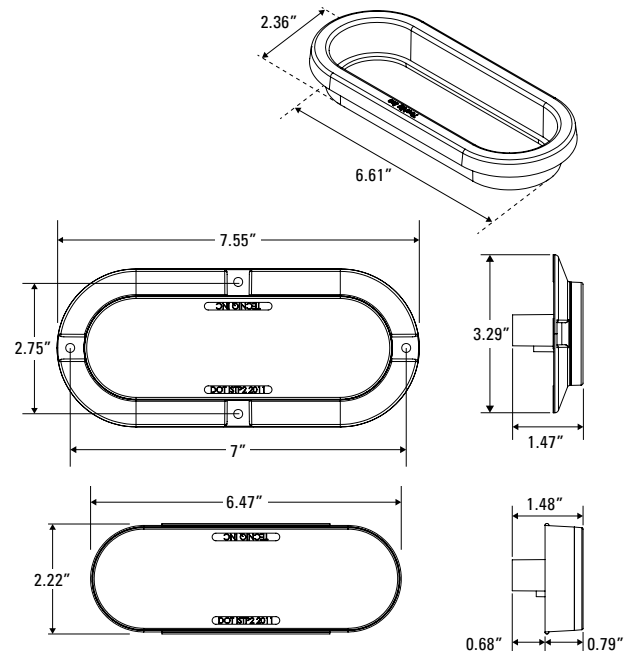

| Part Number | Description  | Amps          | Color              | Std Qty |
|-------------|--|---------------|--------------------|---------|
| T60-0G00-1  | 6" Oval Grommet  |               |                    | -       |
| T61-0B00-1  | 6" Oval Surface Mount Trim Ring Black                              |               |                    | -       |
| T61-0C00-1  | 6" Oval Surface Mount Trim Ring Chrome                             |               |                    | -       |
| T61-0G00-1  | 6" Oval Surface Mount Gasket                                       |               |                    | -       |
| T66-RR0P-1  | 6" Oval 6 LED STT Grommet Mount Red Lens Pigtail                   | 0.17A - 0.28A | Red Lens Pigtail   | 140     |
| T66-RRSP-1  | 6" Oval 6 LED STT Surface Mount Red Lens Pig Tail                  |               | Red Lens Pig Tail  | 140     |
| T66-RC0P-1  | 6" Oval 6 LED STT Grommet Mount Clear Lens Pigtail                 | 0.12A - 0.16A | Clear Lens Pigtail | 140     |
| T66-RCSP-1  | 6" Oval 6 LED STT Surface Mount Clear Lens Pigtail                 |               | Clear Lens Pigtail | 140     |
| T66-AA0P-1  | 6" Oval 6 LED Turn Dual Intensity Grommet Mount Amber Lens Pigtail | 0.17A - 0.28A | Amber Lens Pigtail | 140     |
| T66-AASP-1  | 6" Oval 6 LED Turn Dual Intensity Surface Mount Amber Lens Pigtail |               | Amber Lens Pigtail | 140     |
| T66-AC0P-1  | 6" Oval 6 LED Turn Dual Intensity Grommet Mount Clear Lens Pigtail | 0.12A - 0.16A | Clear Lens Pigtail | 140     |
| T66-WCRP-1  | 6" Oval Reverse 6 LED White Grommet Mount Clear Lens Pigtail       | 0.21A - 0.27A | White Lens Pigtail | 140     |
| T66-WCSP-1  | 6" Oval Reverse 6 LED White Surface Mount Clear Lens Pigtail       |               | White Lens Pigtail | 140     |

\*Custom connectors available upon request



**NEW**

# 4" Round Hi Visibility LED STT Model T460

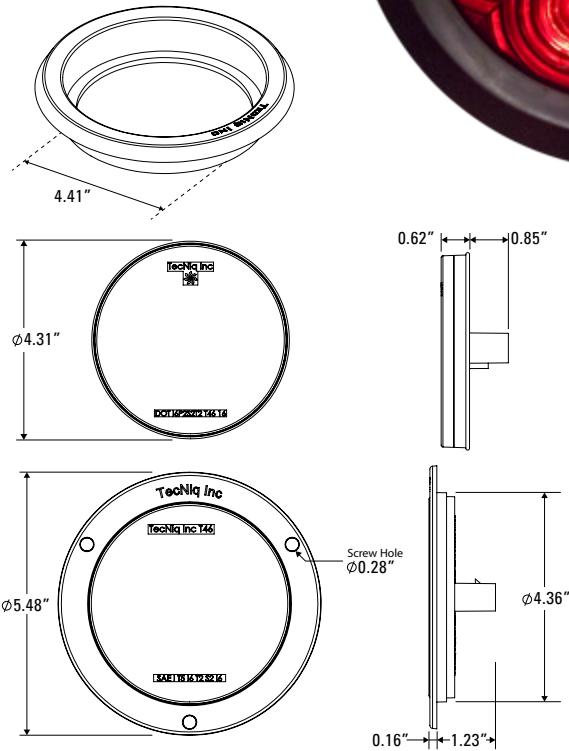

## Features



- Smooth surface, great looking Stop/Tail/Turn Light
- Durable impact resistant lens
- Fit all industry standard 4" round applications
- Available in grommet or flange mount
- TecSeal Urethane Potting - Guaranteed Circuit Board Protection
- Excellent UV Resistance - Automotive exterior lighting grade polycarbonate
- IP68 Rated - Dust and water proof with hermetic seal
- Meets all FMVSS 108 requirements for wide and narrow vehicles
- Reliable performance over 100,000 hours
- Lifetime Warranty

| Part Number | Description   | Amps          | Color      | Std Qty |
|-------------|---|---------------|------------|---------|
| T46-RR0A-1  | Hi Visibility 4" Round STT Red Lens Grommet Mount Amp           | 0.11A - 0.15A | Red Lens   | 100     |
| T46-RR0T-1  | Hi Visibility 4" Round STT Red Lens Grommet Mount Tri-Pole      |               | Red Lens   | 100     |
| T46-RRFA-1  | Hi Visibility 4" Round STT Red Lens Flange Mount Amp            |               | Red Lens   | 100     |
| T46-RRFT-1  | Hi Visibility 4" Round STT Red Lens Flange Mount Tri-Pole       |               | Red Lens   | 100     |
| T46-RC0A-1  | Hi Visibility 4" Round STT Clear Lens Grommet Mount Amp         |               | Clear Lens | 100     |
| T46-RC0T-1  | Hi Visibility 4" Round STT Clear Lens Grommet Mount Tri-Pole    |               | Clear Lens | 100     |
| T46-RCFA-1  | Hi Visibility 4" Round STT Clear Lens Flange Mount Amp          |               | Clear Lens | 100     |
| T46-RCFT-1  | Hi Visibility 4" Round STT Clear Lens Flange Mount Tri-Pole     |               | Clear Lens | 100     |
| T46-AA0A-1  | Hi Visibility 4" Round Amber Turn Amber Lens Amp Connector      | 0.14A - 0.18A | Amber Lens | 100     |
| T46-AA0P-1  | Hi Visibility 4" Round Amber Turn Amber Lens Pig Tail           |               | Amber Lens | 100     |
| T46-AA0T-1  | Hi Visibility 4" Round Amber Turn Amber Lens Tri Pole Connector |               | Amber Lens | 100     |
| T46-AC0A-1  | Hi Visibility 4" Round Amber Turn Clear Lens Amp Connector      |               | Clear Lens | 100     |
| T46-AC0P-1  | Hi Visibility 4" Round Amber Turn Clear Lens Pig Tail           |               | Clear Lens | 100     |
| T46-AC0T-1  | Hi Visibility 4" Round Amber Turn Clear Lens Tri Pole Connector |               | Clear Lens | 100     |

\*Custom connectors available upon request

# 4" Round LED High Visibility STTR Model T450

**NEW**

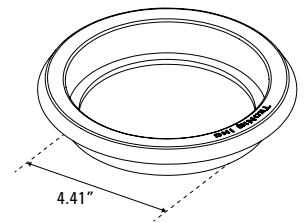

## Features



- Save time and money with our new combination Stop/Tail/Turn and Reverse Light
- Fits all standard 4" round applications
- Available in grommet or flange mount
- High intensity function only draws 0.13A at 12VDC
- Reverse function uses an additional 0.3A
- TecSeal Urethane Potting - Guaranteed Circuit Board Protection
- Excellent UV Resistance - Automotive exterior lighting grade polycarbonate
- IP68 Rated - Dust and water proof with hermetic seal
- Meets all FMVSS 108 requirements for wide and narrow vehicles
- Reliable performance over 100,000 hours
- Lifetime Warranty

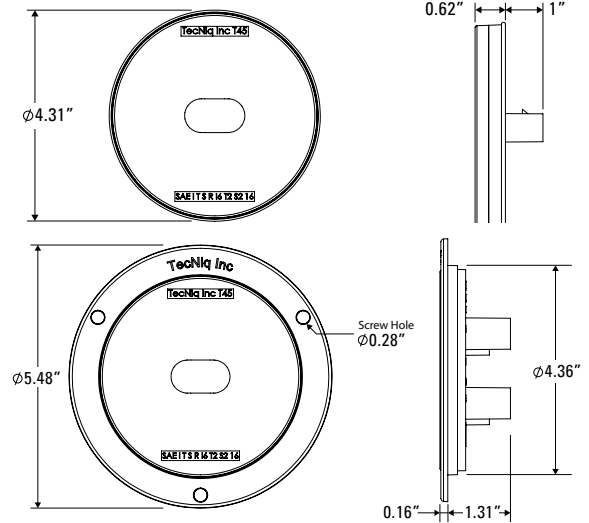

| Part Number | Description                                     | Amps                             | Color | Std Qty |
|-------------|---|----------------------------------|-------|---------|
| T45-RW0A-1  | 4" Round STTR Red Lens Grommet Mount Amp        | 0.11A - 0.15A<br>+0.3A (reverse) |       | 100     |
| T45-RW0P-1  | 4" Round STTR Red Lens Grommet Mount Pig-Tail   |                                  |       | 100     |
| T45-RW0T-1  | 4" Round STTR Red Lens Grommet Mount Tri-Pole   |                                  |       | 100     |
| T45-RWFA-1  | 4" Round STTR Red Lens Flange Mount Amp         |                                  |       | 100     |
| T45-RWFP-1  | 4" Round STTR Red Lens Flange Mount Pig-Tail    |                                  |       | 100     |
| T45-RWFT-1  | 4" Round STTR Red Lens Flange Mount Tri-Pole    |                                  |       | 100     |
| T45-RC0A-1  | 4" Round STTR Clear Lens Grommet Mount Amp      |                                  |       | 100     |
| T45-RC0P-1  | 4" Round STTR Clear Lens Grommet Mount Pig-Tail |                                  |       | 100     |
| T45-RC0T-1  | 4" Round STTR Clear Lens Grommet Mount Tri-Pole |                                  |       | 100     |
| T45-RCFA-1  | 4" Round STTR Clear Lens Flange Mount Amp       |                                  |       | 100     |
| T45-RCFP-1  | 4" Round STTR Clear Lens Flange Mount Pig-Tail  |                                  |       | 100     |
| T45-RCFT-1  | 4" Round STTR Clear Lens Flange Mount Tri-Pole  |                                  |       | 100     |

\*Custom connectors available upon request

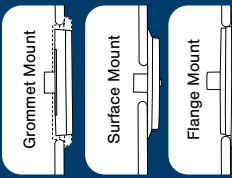

**NEW**

# 6" Oval LED High Visibility STTR Model T700



\*Available as surface mount



\*Can be mounted at any angle

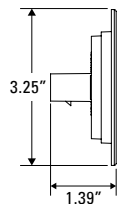
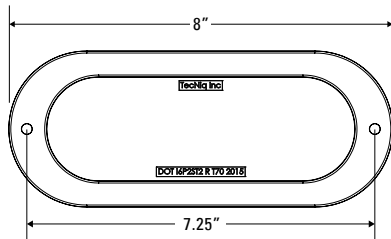
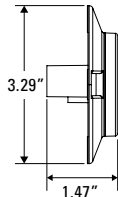
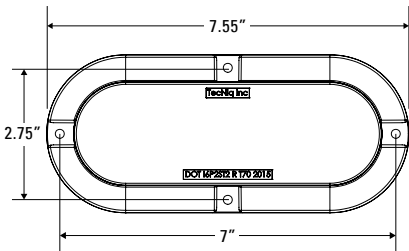
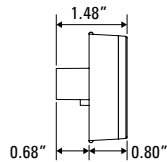
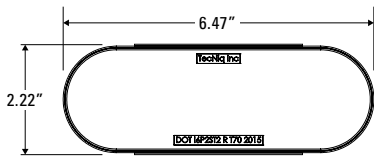
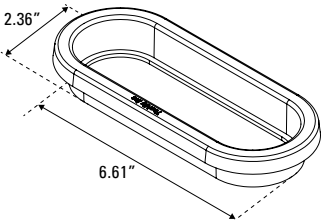

## Features



- Save time and money with our new combination Stop/Tail/Turn and Reverse Light
- Fits all standard 6" oval applications
- 360° optics allow lights to be mounted at any angle
- Available in grommet, surface, or flange mount
- High intensity function only draws 0.14A at 12VDC
- Reverse function uses an additional 0.3A
- IP68 rating while exceeding FMVSS 108 standards
- Lifetime Warranty

| Part Number | Description  | Amps                             | Color | Std Qty |
|-------------|--|----------------------------------|-------|---------|
| T70-RW0P-1  | 6" Oval Stop Tail Turn Reverse Grommet Red Lens 2 Pigtail Connectors   | 0.41A - 0.50A<br>+0.3A (reverse) |       | 140     |
| T70-RWFP-1  | 6" Oval Stop Tail Turn Reverse Flange Red Lens 2 Pigtail Connectors    |                                  |       | 140     |
| T70-RWSP-1  | 6" Oval Stop Tail Turn Reverse Surface Red Lens 2 Pigtail Connectors   |                                  |       | 140     |
| T70-RC0P-1  | 6" Oval Stop Tail Turn Reverse Grommet Clear Lens 2 Pigtail Connectors |                                  |       | 140     |
| T70-RCFP-1  | 6" Oval Stop Tail Turn Reverse Flange Clear Lens 2 Pigtail Connectors  |                                  |       | 140     |
| T70-RCSP-1  | 6" Oval Stop Tail Turn Reverse Surface Clear Lens 2 Pigtail Connectors |                                  |       | 140     |

\*Custom connectors available upon request

# 6" Oval LED Stop/Tail/Turn Model T600



\*Vertical and horizontal styles

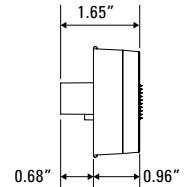
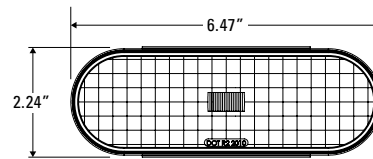
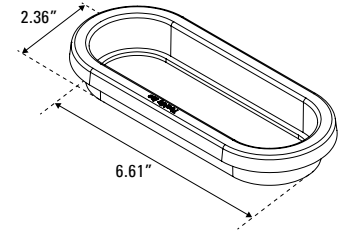

## Features



- Fit all industry standard 6" oval grommet mount applications
- Includes our TPE grommet, offering superior toughness and chemical resistance
- Can be purchased for horizontal or vertical position mounting - separate part numbers
- TecSeal Urethane Potting - Guaranteed Circuit Board Protection
- IP68 Rated - Dust and water proof with hermetic seal
- Durable impact resistant lens
- Meets all FMVSS 108 requirements for wide and narrow vehicles
- Reliable performance over 100,000 hours
- Also available in T610 surface mount version



| Part Number | Description   | Amps          | Color | Std Qty |
|-------------|---|---------------|-------|---------|
| T60-0G00-1  | 6" Oval Grommet   |               |       | -       |
| T60-RRHP-1  | 6" Oval Red STT Horiz. Grommet Mount Red Lens Pig Tail      | 0.17A - 0.23A |       | 140     |
| T60-RRVP-1  | 6" Oval Red STT Vertical Grommet Mount Red Lens Pig Tail    |               |       | 140     |
| T60-RCHP-1  | 6" Oval Red STT Horiz. Grommet Mount Clear Lens Pig Tail    | 0.10A - 0.14A |       | 140     |
| T60-RCVP-1  | 6" Oval Red STT Vertical Grommet Mount Clear Lens Pig Tail  |               |       | 140     |
| T60-AAHP-1  | 6" Oval Amber Turn Horiz. Grommet Mnt Amber Lens Pig Tail   | 0.17A - 0.23A |       | 140     |
| T60-AAVP-1  | 6" Oval Amber Turn Vertical Grommet Mnt Amber Lens Pig Tail |               |       | 140     |
| T60-ACHP-1  | 6" Oval Amber Turn Horiz. Grommet Mount Clear Lens Pig Tail | 0.28A - 0.36A |       | 140     |
| T60-ACVP-1  | 6" Oval Amber Turn Vertical Grommet Mnt Clear Lens Pig Tail |               |       | 140     |
| T60-WCHP-1  | 6" Oval White Light Horiz Grommet Mount Clear Lens Pig Tail | 0.21A - 0.27A |       | 140     |

\*Custom connectors available upon request

# 6" Oval LED Stop/Tail/Turn Model T610



\* Optional chrome trim ring



\* Vertical and horizontal styles

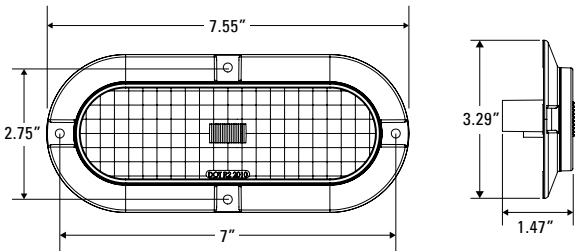

## Features



- Surface mount 6" oval - fits all industry standard applications
- Can be purchased for horizontal or vertical position mounting - separate part numbers
- TecSeal Urethane Potting - Guaranteed Circuit Board Protection
- IP68 Rated - Dust and water proof with hermetic seal
- Durable impact resistant lens
- Meets all FMVSS 108 requirements for wide and narrow vehicles
- Reliable performance over 100,000 hours
- Also available in T600 grommet mount version

| Part Number | Description   | Amps          | Color                      | Std Qty |
|-------------|---|---------------|----------------------------|---------|
| T61-0B00-1  | 6" Oval Surface Mount Trim Ring Black                         |               |                            | -       |
| T61-0C00-1  | 6" Oval Surface Mount Trim Ring Chrome                        |               |                            | -       |
| T61-0G00-1  | 6" Oval Surface Mount Gasket                                  |               |                            | -       |
| T61-RRHP-1  | 6" Oval Red STT Horiz. Surface Mount Red Lens w/Pig-Tail      | 0.17A - 0.23A | Red Lens, Red Pig Tail     | 140     |
| T61-RRVP-1  | 6" Oval Red STT Vertical Surface Mount Red Lens Pig Tail      |               | Red Lens, Red Pig Tail     | 140     |
| T61-RCHP-1  | 6" Oval Red STT Horiz. Surface Mount Clear Lens w/Pig-Tail    | 0.10A - 0.14A | Red Lens, Clear Pig Tail   | 140     |
| T61-RCVP-1  | 6" Oval Red STT Vertical Surface Mount Clear Lens Pig Tail    |               | Red Lens, Clear Pig Tail   | 140     |
| T61-AAHP-1  | 6" Oval Amber Turn Horiz. Surface Mount Amber Lens Pig Tail   | 0.17A - 0.23A | Amber Lens, Amber Pig Tail | 140     |
| T61-AAVP-1  | 6" Oval Amber Turn Vertical Surface Mount Amber Lens Pig Tail |               | Amber Lens, Amber Pig Tail | 140     |
| T61-ACHP-1  | 6" Oval Amber Turn Horiz. Surface Mount Clear Lens Pig Tail   | 0.28A - 0.36A | Amber Lens, Clear Pig Tail | 140     |
| T61-ACVP-1  | 6" Oval Amber Turn Vertical Surface Mnt Clear Lens Pig Tail   |               | Amber Lens, Clear Pig Tail | 140     |
| T61-WCHP-1  | 6" Oval White Light Surface Mount Pig Tails                   | 0.21A - 0.27A | White Lens, White Pig Tail | 140     |

\*Custom connectors available upon request







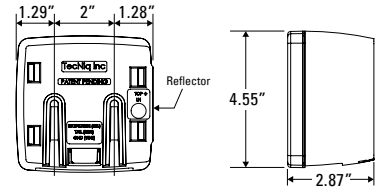

# 4" LED Trailer Light Model T850

## Features



- Multi-Function 4" box tail light
- TecSeal Urethane Potting - Guaranteed Circuit Board Protection
- IP68 Rated - Dust and water proof with hermetic seal
- Durable impact resistant lens
- Meets all FMVSS 108 requirements for narrow and wide vehicles
- Reliable performance over 100,000 hours
- Fits standard mounting as a direct replacement
- Functions include : Stop • Turn • Tail • Clearance • Side marker • Side Reflector • Rear Reflector • License Plate Light (Left)



| Part Number | Description   | Amps                            | Color   | Std Qty |
|-------------|---|---------------------------------|---|---------|
| T85-RRLG-1  | 8 Function 4" Box Tail Light Left Side Pig Tail w/ Ground Ring  | 0.15A - 0.19A<br>+0.15A (brake) |     | 32      |
| T85-RRLP-1  | 8 Function 4" Box Tail Light Left Side Pig Tail                 |                                 |     | 32      |
| T85-RRRG-1  | 7 Function 4" Box Tail Light Right Side Pig Tail w/ Ground Ring | 0.05A - 0.09A<br>+0.15A (brake) |     | 32      |
| T85-RRRP-1  | 7 Function 4" Box Tail Light Right Side Pig Tail                |                                 |   | 32      |

\*Custom connectors available upon request

# 6" LED Trailer Light Model T860

## Features



- Multi-Function 6" box tail light
- TecSeal Urethane Potting - Guaranteed Circuit Board Protection
- IP68 Rated - Dust and water proof with hermetic seal
- Durable impact resistant lens
- Meets all FMVSS 108 requirements for narrow and wide vehicles
- Reliable performance over 100,000 hours
- Fits standard mounting as a direct replacement
- Functions include : Stop • Turn • Tail • Clearance • Side marker • Side Reflector • Rear Reflector • License Plate Light (Left)

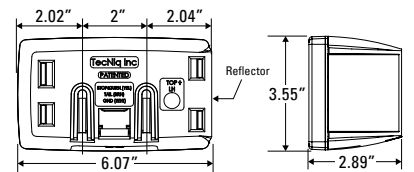
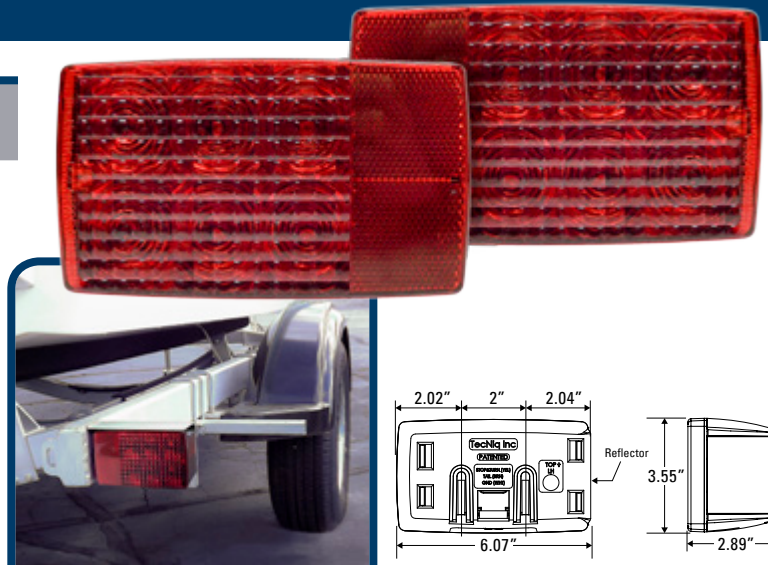

| Part Number | Description  | Amps                            | Color   | Std Qty |
|-------------|--|---------------------------------|---|---------|
| T86-RRLG-1  | 8 Function 6" Box Light Left Side Pig Tail w/ Ground Ring  | 0.14A - 0.17A<br>+0.15A (brake) |   | 32      |
| T86-RRLP-1  | 8 Function 6" Box Light Left Side Pig Tail                 |                                 |   | 32      |
| T86-RRRG-1  | 7 Function 6" Box Light Right Side Pig Tail w/ Ground Ring | 0.06A - 0.08A<br>+0.15A (brake) |   | 32      |
| T86-RRRP-1  | 7 Function 6" Box Light Right Side Pig Tail                |                                 |   | 32      |

\*Custom connectors available upon request



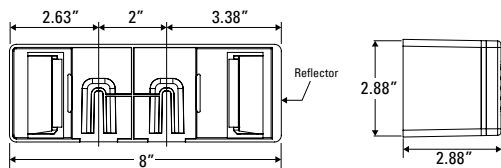





# 8" LED Trailer Light Model T800



## Features



- Multi-Function 8" low profile tail light
- TecSeal Urethane Potting - Guaranteed Circuit Board Protection
- IP68 Rated - Dust and water proof with hermetic seal
- Durable impact resistant lens
- Meets all FMVSS 108 requirements for narrow and wide vehicles
- Reliable performance over 100,000 hours
- Fits standard mounting as a direct replacement
- Functions include : Stop • Turn • Tail • Clearance • Side marker • Side Reflector • Rear Reflector • License Plate Light (Left)

| Part Number | Description   | Amps                            | Color   | Std Qty |
|-------------|---|---------------------------------|---|---------|
| T80-RRLG-1  | 8 Function 8" Box Tail Light Left Side Pig Tail w/ Ground Ring  | 0.14A - 0.20A<br>+0.15A (brake) |   | 32      |
| T80-RRLP-1  | 8 Function 8" Box Tail Light Left Side Pig Tail                 |                                 |   | 32      |
| T80-RRRG-1  | 7 Function 8" Box Tail Light Right Side Pig Tail w/ Ground Ring | 0.06A - 0.09A<br>+0.15A (brake) |   | 32      |
| T80-RRRP-1  | 7 Function 8" Box Tail Light Right Side Pig Tail                |                                 |   | 32      |

\*Custom connectors available upon request



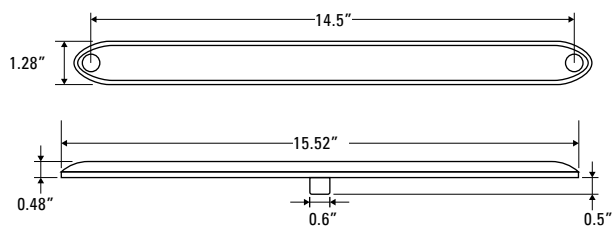
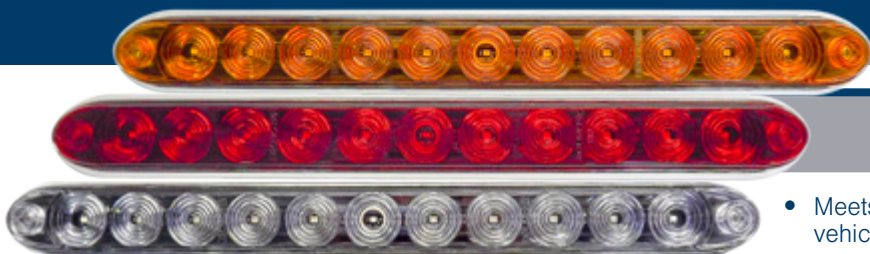







# Stop/Tail/Turn Model T100



## Features



- Meets all FMVSS 108 requirements for wide and narrow vehicles
- IP68 Rated - Dust and water proof with hermetic seal
- TecSeal Urethane Potting - Guaranteed Circuit Board Protection
- Durable impact resistant lens
- Excellent UV Resistance - Automotive exterior lighting grade polycarbonate
- Reliable performance over 100,000 hours
- Can be mounted horizontal, vertical, or at any angle

| Part Number | Description                                  | Amps          | Color   | Std Qty |
|-------------|--|---------------|---|---------|
| T10-0B00-1  | Black Bezel                                  |               |   | 100     |
| T10-0C00-1  | Chrome Bezel                                 |               |   | 100     |
| T10-RR00-1  | Red Low Profile STT Red Lens                 | 0.22A - 0.29A |   | 100     |
| T10-RC00-1  | Red Low Profile STT Clear Lens               | 0.11A - 0.23A |   | 100     |
| T10-AA00-1  | Amber Low Profile Turn Sidemarker Amber Lens | 0.17A - 0.23A |   | 100     |
| T10-AC00-1  | Amber Low Profile Turn Sidemarker Clear Lens |               |   | 100     |
| T10-LC00-1  | Low Profile Auxiliary Light                  | 0.31A - 0.38A |   | 100     |

\*Custom connectors available upon request



# Over 80" Identification Bar Model T120

## Features



- Meets all FMVSS 108 requirements for wide and narrow vehicles
- IP68 Rated - Dust and water proof with hermetic seal
- TecSeal Urethane Potting - Guaranteed Circuit Board Protection
- Durable impact resistant lens
- Excellent UV Resistance - Automotive exterior lighting grade polycarbonate
- Reliable performance over 100,000 hours
- Can be mounted horizontal, vertical, or at any angle

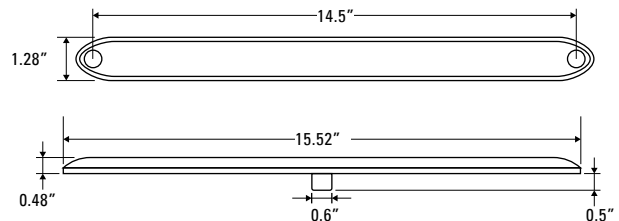

| Part Number | Description                         | Amps          | Color | Std Qty |
|-------------|-------------------------------------|---------------|-------|---------|
| T12-RR00-1  | Red Low Profile ID Bar Red Lens     | 0.04A - 0.07A |       | 100     |
| T12-RC00-1  | Red Low Profile ID Bar Clear Lens   |               |       | 100     |
| T12-AA00-1  | Amber Low Profile ID Bar Amber Lens |               |       | 100     |
| T12-AC00-1  | Amber Low Profile ID Bar Clear Lens |               |       | 100     |
| T12-RW00-1  | Red ID Bar/Load Lamp Clear Lens     | 0.33A - 0.40A |       | 100     |

\*Custom connectors available upon request

# V-Shaped Over 80" Identification Bar Model S520

**NEW**



## Features



- Fully submersible LED Identification bar
- TecSeal Urethane Potting - Guaranteed Circuit Board Protection
- Durable impact resistant lens
- Available in colored or clear impact resistant lens
- IP68 rating while exceeding FMVSS 108 standards
- Reliable performance over 100,000 hours

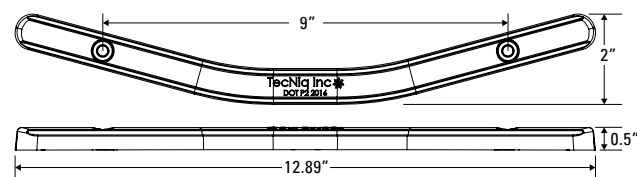

| Part Number | Description  | Amps          | Color | Std Qty |
|-------------|--|---------------|-------|---------|
| S52-RR00-1  | V-Shaped Over 80" Tri-Bar Red LED, Red Lens, Pigtail       | 0.07A - 0.09A |       | 25      |
| S52-RR10-1  | V-Shaped Over 80" Tri-Bar Red LED, Red Lens, 58" Pigtail   |               |       | 25      |
| S52-RC00-1  | V-Shaped Over 80" Tri-Bar Red LED, Clear Lens, Pigtail     |               |       | 25      |
| S52-RC10-1  | V-Shaped Over 80" Tri-Bar Red LED, Clear Lens, 58" Pigtail |               |       | 25      |

\*Custom connectors available upon request



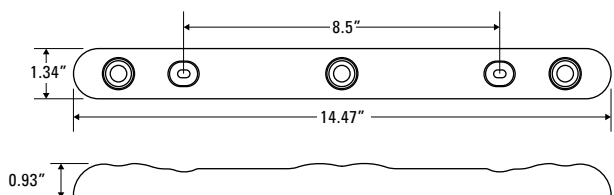





# Over 80" Identification Bar Model S500



## Features



- Fully submersible over 80" ID bar
- Rugged impact resistant design
- Available in colored or clear impact resistant lens
- TecSeal Urethane Potting - Guaranteed Circuit Board Protection
- IP68 rating while exceeding FMVSS 108 standards
- Reliable performance over 100,000 hours

| Part Number | Description                         | Amps          | Color   | Std Qty |
|-------------|-------------------------------------|---------------|---|---------|
| S50-RRB0-1  | Tri-Bar Red Red Lens Black Body     | 0.18A - 0.24A |     | 25      |
| S50-RCB0-1  | Tri-Bar Red Clear Lens Black Body   |               |     | 25      |
| S50-AAB0-1  | Tri-Bar Amber Amber Lens Black Body |               |     | 25      |
| S50-ACB0-1  | Tri-Bar Amber Clear Lens Black Body |               |   | 25      |

\*Custom connectors available upon request



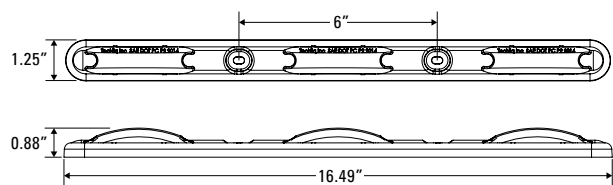





# Over 80" Identification Bar Model S510



## Features



- Fully submersible over 80" ID bar
- New sleek design matches S180 side marker
- TecSeal Urethane Potting - Guaranteed Circuit Board Protection
- Durable impact resistant lens
- Available in colored or clear impact resistant lens
- IP68 rating while exceeding FMVSS 108 standards
- Reliable performance over 100,000 hours

| Part Number | Description  | Amps          | Color   | Std Qty |
|-------------|--|---------------|---|---------|
| S51-RR00-1  | Tri-Bar Red LED, Red Lens, Black Body, Pigtail     | 0.16A - 0.20A |   | 25      |
| S51-RC00-1  | Tri-Bar Red LED, Clear Lens, Black Body, Pigtail   |               |   | 25      |
| S51-AA00-1  | Tri-Bar Amber LED, Amber Lens, Black Body, Pigtail |               |   | 25      |
| S51-AC00-1  | Tri-Bar Amber LED, Clear Lens, Black Body, Pigtail |               |   | 25      |

\*Custom connectors available upon request

# 2" Vertical Plane License Plate Light Model L100

## Features



- SAE DOT rated
- IP68 Rated - Dust and water proof
- TecSeal Urethane Potting - Guaranteed Circuit Board Protection
- Durable impact resistant lens
- Life performance over 50,000 hours
- Easily mounts using just two screws
- Available in our black or chrome finish



\*Also available in black

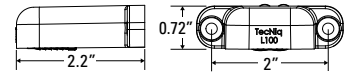

| Part Number | Description                                   | Amps          | Color   | Std Qty |
|-------------|---|---------------|---|---------|
| L95-0B00-1  | License Plate Bracket, Black                  |               |   | -       |
| L10-WB00-1  | Black Base License Lamp Vertical Plane Mount  | 0.06A - 0.11A | <input type="checkbox"/> <input type="checkbox"/> | 10      |
| L10-WC00-1  | Chrome Base License Lamp Vertical Plane Mount |               | <input type="checkbox"/> <input type="checkbox"/> | 10      |

\*Custom connectors available upon request

# 1" Vertical Plane License Plate Light Model L110

## Features



- SAE DOT rated
- IP68 Rated - Dust and water proof
- TecSeal Urethane Potting - Guaranteed Circuit Board Protection
- Durable impact resistant lens
- Life performance over 50,000 hours
- Easily mounts using just two screws
- Available in our black or chrome finish



\*Also available in black

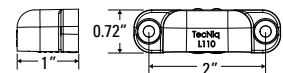

| Part Number | Description                                   | Amps          | Color   | Std Qty |
|-------------|---|---------------|---|---------|
| L95-0B00-1  | License Plate Bracket, Black                  |               |   | -       |
| L11-WB00-1  | Black Base License Lamp Vertical Plane Mount  | 0.06A - 0.11A | <input type="checkbox"/> <input type="checkbox"/> | 10      |
| L11-WC00-1  | Chrome Base License Lamp Vertical Plane Mount |               | <input type="checkbox"/> <input type="checkbox"/> | 10      |

\*Custom connectors available upon request

# 3/4" Horizontal Plane License Plate Light Model L120



\* Also available in black

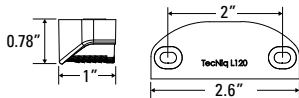

## Features



- SAE DOT rated
- IP68 Rated - Dust and water proof
- TecSeal Urethane Potting - Guaranteed Circuit Board Protection
- Durable impact resistant lens
- Life performance over 50,000 hours
- Easily mounts using just two screws
- Available in our black or chrome finish

| Part Number | Description                                     | Amps          | Color   | Std Qty |
|-------------|---|---------------|---|---------|
| L95-0B00-1  | License Plate Bracket, Black                    |               |   | -       |
| L12-WB00-1  | Black Base License Lamp Horizontal Plane Mount  | 0.06A - 0.11A | <input type="checkbox"/> <input type="checkbox"/> | 10      |
| L12-WC00-1  | Chrome Base License Lamp Horizontal Plane Mount |               | <input type="checkbox"/> <input type="checkbox"/> | 10      |

\*Custom connectors available upon request

# 3/4" Grommet License Plate Light Model L340

**NEW**

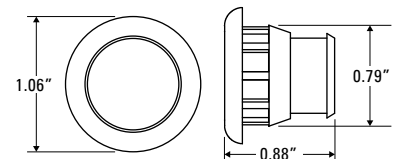

\*Steel Bracket not included

## Features



- SAE DOT Rated
- IP68 Rated - Dust and water proof
- TecSeal Urethane Potting - Guaranteed Circuit Board Protection
- Durable impact resistant lens
- Easily mounts into standard 3/4" hole also available with large grommet style (1.19" mounting hole)
- Life performance over 50,000 hours

| Part Number | Description  | Amps          | Color   | Std Qty |
|-------------|--|---------------|---|---------|
| L34-WC9B-1  | 3/4" Bullet style License Lamp, Large Grommet w/ .180 bullets    | 0.07A - 0.09A | <input type="checkbox"/> <input type="checkbox"/> | 10      |
| L34-WG9B-1  | 3/4" Bullet Style License Lamp, Standard Grommet w/ .180 bullets |               | <input type="checkbox"/> <input type="checkbox"/> | 10      |

\*Custom connectors available upon request

# 1"x 2" Surface Mounted Sidemarker Model S150

PC/P2  
RATED

## Features









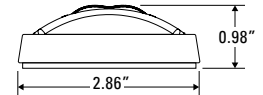
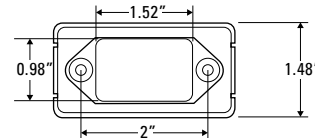
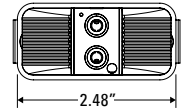
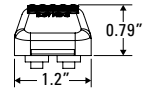

- Surface mount installation, with our durable mounting base
- Excellent UV Resistance - Automotive exterior lighting grade polycarbonate
- TecSeal Urethane Potting - Guaranteed Circuit Board Protection
- IP68 Rated - Dust and water proof
- Durable impact resistant lens
- Exceeds FMVSS 108 standards
- Reliable performance over 100,000 hours
- Standard non-polarized connector



\*Mounting bases available in chrome or black



| Part Number | Description                               | Amps          | Color   | Std Qty |
|-------------|---|---------------|---|---------|
| S15-0B00-1  | Model S150 Base Black                     |               |   | 100     |
| S15-0S00-1  | Model S150 Base Chrome                    |               |   | 100     |
| S15-0G00-1  | Model S150 Grommet                        |               |   | 100     |
| S15-RR00-1  | Model S150 Red PC Sidemarker Red Lens     | 0.04A - 0.07A |     | 120     |
| S15-RC00-1  | Model S150 Red PC Sidemarker Clear Lens   |               |     | 120     |
| S15-AA00-1  | Model S150 Amber PC Sidemarker Amber Lens |               |     | 120     |
| S15-AC00-1  | Model S150 Amber PC Sidemarker Clear Lens |               |   | 120     |

\*Custom connectors available upon request

# 1"x 4" Surface Mounted Sidemarker Model S190

PC/P2  
RATED

## Features









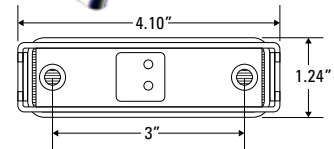
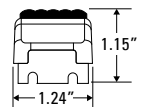

- Easily installed surface mounted with self-grounding base
- Standard non-polarized male connector
- TecSeal Urethane Potting - Guaranteed Circuit Board Protection
- IP68 Rated - Dust and water proof
- Durable impact resistant lens
- Exceeds FMVSS 108 standards
- Reliable life performance over 100,000 hours



\*Mounting bases available in chrome or black



| Part Number | Description                          | Amps          | Color   | Std Qty |
|-------------|--------------------------------------|---------------|---|---------|
| S19-0B00-1  | Black 1" x4" Self Grounding Base     |               |   | 120     |
| S19-0C00-1  | Chrome 1" x4" Self Grounding Base    |               |   | 120     |
| S19-RR00-1  | 1"x4" Red PC Sidemarker Red Lens     | 0.04A - 0.07A |   | 120     |
| S19-RC00-1  | 1"x4" Red PC Sidemarker Clear Lens   |               |   | 120     |
| S19-AA00-1  | 1"x4" Amber PC Sidemarker Amber Lens |               |   | 120     |
| S19-AC00-1  | 1"x4" Amber PC Sidemarker Clear Lens |               |   | 120     |

\*Custom connectors available upon request

**P2  
RATED**

# 2.5" Round Sidemarker w/ Reflector Model S100







## Features

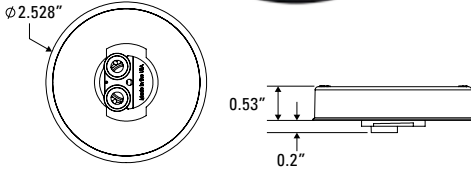

- TecSeal Urethane Potting - Guaranteed Circuit Board Protection
- Excellent UV Resistance - Automotive exterior lighting grade polycarbonate
- IP68 Rated - Dust and water proof with hermetic seal
- Durable impact resistant lens
- Exceeds FMVSS 108 standards
- Reliable performance over 100,000 hours
- Standard non-polarized connector
- Energy efficient: Draws only 0.06A at 12VDC



| Part Number | Description                                      | Amps          | Color   | Std Qty |
|-------------|--|---------------|---|---------|
| S10-0G00-1  | 2.5" Round Sidemarker Grommet                    |               |   | 150     |
| S10-RR00-1  | 2.5" Round Red P2 Sidemarker with Reflectivity   | 0.06A - 0.08A |   | 150     |
| S10-AA00-1  | 2.5" Round Amber P2 Sidemarker with Reflectivity |               |   | 150     |

\*Custom connectors available upon request

**P2  
RATED**

# 2" Round Sidemarker Model S300









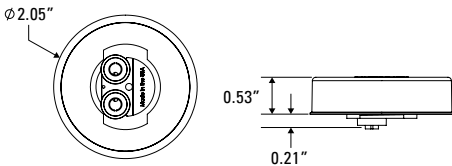







## Features



- Grommet mounted industry standard size
- Standard non-polarized connector
- TecSeal Urethane Potting - Guaranteed Circuit Board Protection
- Excellent UV Resistance - Automotive exterior lighting grade polycarbonate
- IP68 Rated - Dust and water proof with hermetic seal
- Durable impact resistant lens
- Exceeds FMVSS 108 standards
- Reliable performance over 100,000 hours



| Part Number | Description                                      | Amps          | Color   | Std Qty |
|-------------|--|---------------|---|---------|
| S30-0G00-1  | 2" Round Sidemarker Grommet                      |               |   | 125     |
| S30-RR00-1  | 2" Round Red Sidemarker Red Lens                 | 0.06A - 0.08A |   | 125     |
| S30-RR0P-1  | 2" Round Red Sidemarker Red Lens w/ Pig Tail     |               |   | 125     |
| S30-RC00-1  | 2" Round Red Sidemarker Clear Lens               | 0.04A - 0.07A |   | 125     |
| S30-RC0P-1  | 2" Round Red Sidemarker Clear Lens w/ Pig Tail   |               |   | 125     |
| S30-AA00-1  | 2" Round Amber Sidemarker Amber Lens             | 0.06A - 0.08A |   | 125     |
| S30-AA0P-1  | 2" Round Amber Sidemarker Amber Lens w/ Pig Tail |               |   | 125     |
| S30-AC00-1  | 2" Round Amber Sidemarker Clear Lens             | 0.04A - 0.07A |   | 125     |

\*Custom connectors available upon request

# 3/4" Grommet Mounted Sidemarker Model S340

PC/P2  
RATED



\*Optional stainless steel trim ring

## Features









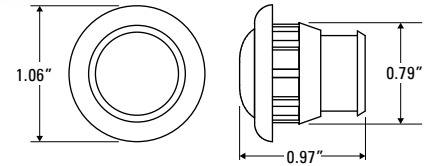





- Easily mounts into standard 3/4" hole
- IP68 Rated - Dust and water proof
- Durable impact resistant lens
- 316 stainless steel trim ring available
- PC/P2 output exceeds FMVSS 108 specifications
- Reliable performance over 100,000 hours



\*Three light model for ID bar



| Part Number | Description                                      | Amps          | Color   | Std Qty |
|-------------|--|---------------|---|---------|
| S33-OS00-1  | Stainless Steel Trim Ring for S33 and S34        |               |   | 100     |
| S34-RR00-1  | Red Mini PC Sidemarker Red Lens                  | 0.07A - 0.09A |   | 100     |
| S34-RC00-1  | Red Mini PC Sidemarker Clear Lens                | 0.06A - 0.08A |   | 100     |
| S34-RR30-1  | Red Mini 3 Light PC Over 80 ID assembly 12" Lead | 0.22A - 0.26A |   | 100     |
| S34-RR31-1  | Red Mini 3 Light PC Over 80 ID assembly 48" Lead |               |   | 100     |
| S34-AA00-1  | Amber Mini PC Sidemarker Amber Lens              | 0.07A - 0.09A |   | 100     |
| S34-AC00-1  | Amber Mini PC Sidemarker Clear Lens              | 0.03A - 0.06A |   | 100     |

\*Custom connectors available upon request

# 3/4" Mini Grommet Mounted Sidemarker Model S370

PC/P2  
RATED









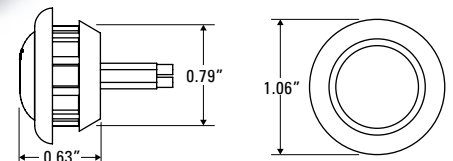





NEW

## Features



- New mini 3/4" grommet mount clearance markers, half the depth allowing for installation in very tight spaces.
- TecSeal Urethane Potting - Guaranteed Circuit Board Protection
- IP68 Rated - Dust and water proof
- 316 stainless steel trim ring available
- PC/P2 output exceeds FMVSS 108 specifications
- Reliable performance over 100,000 hours



| Part Number | Description                                       | Amps          | Color   | Std Qty |
|-------------|---|---------------|---|---------|
| S37-RR09-1  | Red Mini Grommet Mount PC Sidemarker Red Lens     | 0.06A - 0.08A |   | 100     |
| S37-RC09-1  | Red Mini Grommet Mount PC Sidemarker Clear Lens   | 0.07A - 0.09A |   | 100     |
| S37-AA09-1  | Amber Mini Grommet Mount PC Sidemarker Amber Lens | 0.07A - 0.09A |   | 100     |
| S37-AC09-1  | Amber Mini Grommet Mount PC Sidemarker Clear Lens | 0.03A - 0.06A |   | 100     |
| S37-BC09-1  | Blue Mini Grommet Mount Accent Light Clear Lens   | 0.03A - 0.04A |   | 100     |
| S37-GC09-1  | Green Mini Grommet Mount Accent Light Clear Lens  |               |   | 100     |
| S37-WC09-1  | White Mini Grommet Mount Accent Light Clear Lens  | 0.07A - 0.09A |   | 100     |

\*Custom connectors available upon request

**P2  
RATED**

# 2" Surface Mounted Sidemarker Model S210



\* Optional stainless steel trim ring

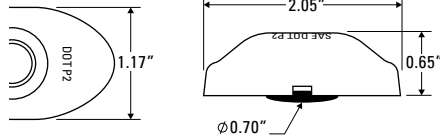

## Features



- Another great combination of appealing appearance and extreme durability
- Optional 316 stainless steel cover, hides the fasteners
- TecSeal Urethane Potting - Guaranteed Circuit Board Protection
- IP68 Rated - Dust and water proof
- Exceeds FMVSS 108 standards
- Reliable performance over 100,000 hours

| Part Number | Description  | Amps          | Color | Std Qty |
|-------------|--|---------------|-------|---------|
| S21-0G00-1  | Sidemarker Gasket                                      |               |       | 100     |
| S21-0G20-1  | Sidemarker Molded Rubber Gasket                        |               |       |         |
| S21-0S00-1  | 2" Oval Sidemarker SS Trim Ring                        |               |       | 100     |
| S21-RR00-1  | 2" Oval Red Sidemarker Red Lens Pigtail Connection     | 0.04A - 0.07A |       | 100     |
| S21-RC00-1  | 2" Oval Red Sidemarker Clear Lens Pigtail Connection   |               |       | 100     |
| S21-AA00-1  | 2" Oval Amber Sidemarker Amber Lens Pigtail Connection |               |       | 100     |
| S21-AC00-1  | 2" Oval Amber Sidemarker Clear Lens Pigtail Connection |               |       | 100     |

\*Custom connectors available upon request

**PC/P2  
RATED**

**NEW**

# Surface Mounted Sidemarker Model S380

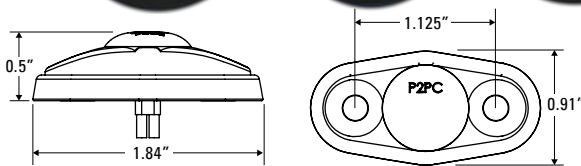
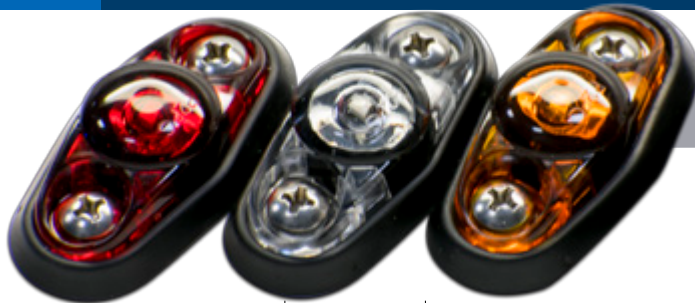

## Features



- New surface mounted mini clearance markers, offer a great appearance, easy installation, and can be purchased with available gasket.
- Easily mounts with two screws
- TecSeal Urethane Potting - Guaranteed Circuit Board Protection
- IP68 Rated - Dust and water proof
- PC/P2 output exceeds FMVSS 108 specifications
- Reliable performance over 100,000 hours

| Part Number | Description                                       | Amps          | Color | Std Qty |
|-------------|---|---------------|-------|---------|
| S38-RR09-1  | Red Mini Surface Mount PC Sidemarker Red Lens     | 0.07A - 0.09A |       | 100     |
| S38-RC09-1  | Red Mini Surface Mount PC Sidemarker Clear Lens   | 0.06A - 0.08A |       | 100     |
| S38-AA09-1  | Amber Mini Surface Mount PC Sidemarker Amber Lens | 0.07A - 0.09A |       | 100     |
| S38-AC09-1  | Amber Mini Surface Mount PC Sidemarker Clear Lens | 0.03A - 0.06A |       | 100     |
| S38-BC09-1  | Blue Mini Surface Mount Accent Light Clear Lens   | 0.03A - 0.04A |       | 100     |
| S38-GC09-1  | Green Mini Surface Mount Accent Light Clear Lens  |               |       | 100     |
| S38-WC09-1  | White Mini Surface Mount Accent Light Clear Lens  | 0.07A - 0.09A |       | 100     |

\*Custom connectors available upon request



# Surface Mounted Sidemarker Model S180

PC/P2  
RATED

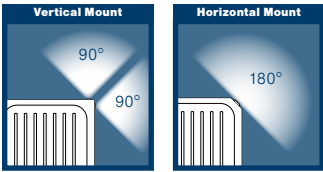

\*White area light version available



## Features



- Great combination of sleek, smooth design that is extremely tough
- Vertical mount position meets P2 specifications, while horizontal mount meets PC specifications.
- Excellent UV Resistance - Automotive exterior lighting grade polycarbonate
- TecSeal Urethane Potting - Guaranteed Circuit Board Protection
- IP68 Rated - Dust and water proof
- Durable impact resistant lens
- Exceeds FMVSS 108 standards
- Reliable life performance over 100,000 hours

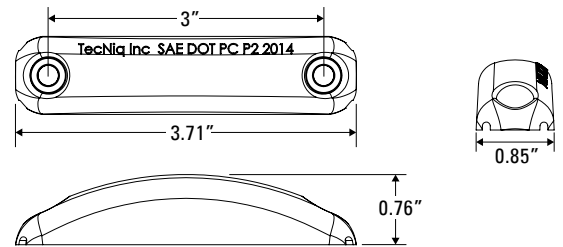

| Part Number | Description  | Amps          | Color | Std Qty |
|-------------|--|---------------|-------|---------|
| S18-RR00-1  | 3.5"x.75" Surface mount P2/PC rated Red sidemarker Hardwired         | 0.06A - 0.08A |       | 10      |
| S18-RRG0-1  | 3.5"x.75" Surface mount P2/PC rated Red sidemarker Self Ground       |               |       | 10      |
| S18-RC00-1  | 3.5"x.75" Surface mount P2/PC rated Red/Clear sidemarker Hardwired   | 0.05A - 0.07A |       | 10      |
| S18-RCG0-1  | 3.5"x.75" Surface mount P2/PC rated Red/Clear sidemarker Self Ground |               |       | 10      |
| S18-AA00-1  | 3.5"x.75" Surface mount P2/PC rated Amber sidemarker Hardwired       | 0.06A - 0.08A |       | 10      |
| S18-AAG0-1  | 3.5"x.75" Surface mount P2/PC rated Amber Sidemarker Self Ground     |               |       | 10      |
| S18-AC00-1  | 3.5"x.75" Surface mount P2/ PC rated Amber/Clr sidemarker Hardwired  | 0.05A - 0.07A |       | 10      |
| S18-ACG0-1  | 3.5"x.75" Surface mount P2/PC rated Amber/Clr sidemarker Self Ground |               |       | 10      |
| S18-WC00-1  | 3.5"x.75" Surface Mount Area Light hardwired                         | 0.10A - 0.15A |       | 10      |

\*Custom connectors available upon request

# Low Profile Sidemarker Model S170

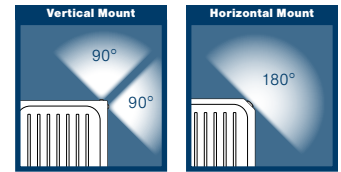

\*Optional chrome mounting bezel

## Features



- Surface mounted PC/P2 rated marker light
- Optional chrome bezel, offers premium appearance
- Custom fit TPE gaskets also available
- Automotive exterior lighting grade polycarbonate
- TecSeal Urethane Potting - Guaranteed Circuit Board Protection
- IP68 Rated - Dust and water proof
- Exceeds FMVSS 108 standards
- Reliable performance over 100,000 hours

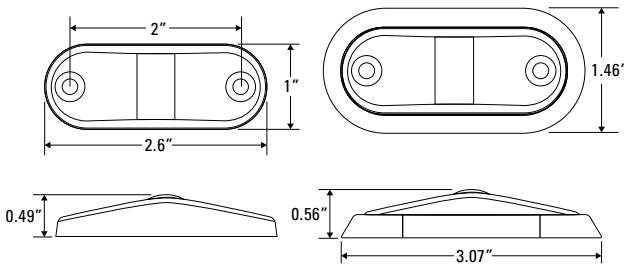

| Part Number | Description  | Amps          | Color | Std Qty |
|-------------|--|---------------|-------|---------|
| S17-0B00-1  | Model S170 Black Base                                    |               |       | 10      |
| S17-0G00-1  | Model S170 Gasket - Small                                |               |       | 10      |
| S17-0C00-1  | Model S170 Chrome Base                                   |               |       | 10      |
| S17-0GC0-1  | Model S170 Chrome Base & Gasket - Large                  |               |       | 10      |
| S17-RR0P-1  | Model S170 Red P2/PC Sidemarker Red Lens 6" Pigtail      | 0.07A - 0.09A |       | 10      |
| S17-RRG0-1  | Model S170 Red P2/PC Sidemarker Red Lens Self Ground     |               |       | 10      |
| S17-RC0P-1  | Model S170 Red P2/PC Sidemarker Clear Lens 6" Pigtail    | 0.04A - 0.07A |       | 10      |
| S17-RCG0-1  | Model S170 Red P2/PC Sidemarker Clear Lens Self Ground   |               |       | 10      |
| S17-AA0P-1  | Model S170 Amber P2/PC Sidemarker Amber Lens 6" Pigtail  | 0.07A - 0.09A |       | 10      |
| S17-AAG0-1  | Model S170 Amber P2/PC Sidemarker Amber Lens Self Ground |               |       | 10      |
| S17-AC0P-1  | Model S170 Amber P2/PC Sidemarker Clear Lens 6" Pigtail  | 0.04A - 0.07A |       | 10      |
| S17-ACG0-1  | Model S170 Amber P2/PC Sidemarker Clear Lens Self Ground |               |       | 10      |

\*Custom connectors available upon request

# Low Profile Stud Mounted Sidemarker Model S140

PC/P2  
RATED

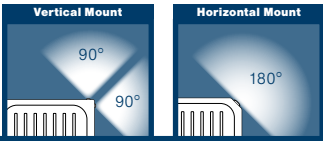







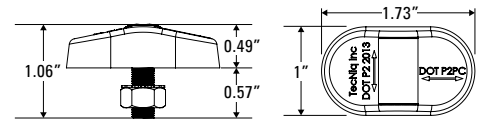

## Features



- Brilliant illumination in a compact size
- IP68 Rated - Dust and water proof
- TecSeal Urethane Potting - Guaranteed Circuit Board Protection
- Stud-mounted, no visible fasteners
- Exceeds FMVSS 108 standards
- Reliable performance over 100,000 hours
- Vertical mount position meets P2 specifications, while horizontal mount meets PC specifications



| Part Number | Description   | Amps          | Color   | Std Qty |
|-------------|---|---------------|---|---------|
| S14-RRS0-1  | S14 Red PCP2 Stud Mount Marker Light Red Lens Pigtail     | 0.04A - 0.07A |   | 100     |
| S14-RCS0-1  | S14 Red PCP2 Stud Mount Marker Light Clear Lens Pigtail   |               |   | 100     |
| S14-AAS0-1  | S14 Amber PCP2 Stud Mount Marker Light Amber Lens Pigtail |               |   | 100     |
| S14-ACS0-1  | S14 Amber PCP2 Stud Mount Marker Light Clear Lens Pigtail |               |   | 100     |

\*Custom connectors available upon request

# Rugged Dual LED Fender Light Model S900



\*Optional stainless steel trim ring

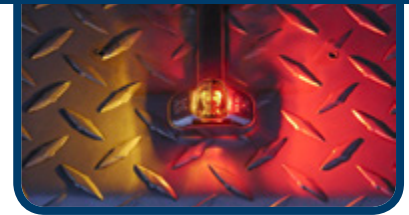





## Features

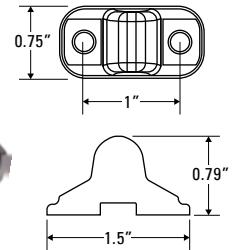

- Completely submersible bi-color red/amber LED fender light
- Low profile design
- TecSeal Urethane Potting - Guaranteed Circuit Board Protection
- IP68 Rated - Dust and water proof
- Durable impact resistant lens
- Reliable performance over 100,000 hours

\* Available with two or four mounting holes



| Part Number | Description                                      | Amps          | Color   | Std Qty |
|-------------|--|---------------|---|---------|
| S90-0000-1  | Fender Sidemarker Light                          | 0.04A - 0.07A |   | 150     |
| S90-00G0-1  | Fender Sidemarker Light with Grounding Ring      |               |   | 150     |
| S90-0BS0-1  | Fender Sidemarker Light Wire Guide 4 Hole Black  |               |   | 150     |
| S90-0CS0-1  | Fender Sidemarker Light Wire Guide 4 Hole Chrome |               |   | 150     |
| S90-0SS0-1  | Fender Sidemarker Light SS Stamping              |               |   | 150     |

\*Custom connectors available upon request

# 4" Surface Mounted Fender Light Model S910

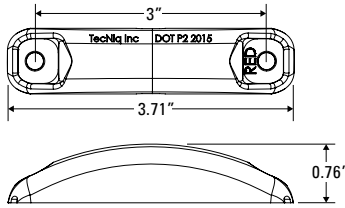
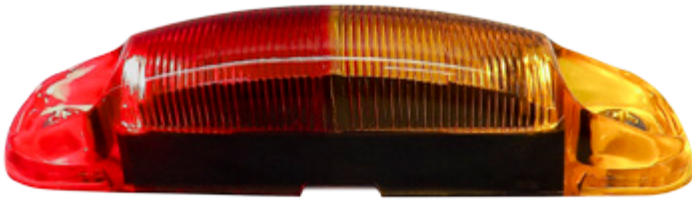

## Features



- New fender light with excellent durability
- Fully submersible bi-color red/amber LED fender light
- Part of the S180 side marker family
- TecSeal Urethane Potting - Guaranteed Circuit Board Protection
- Excellent UV Resistance - Automotive exterior lighting grade polycarbonate
- IP68 Rated - Dust and water proof
- Reliable performance over 100,000 hours
- Low amp draw Easily mounts with just two screws

## Wires, Connectors, and Accessories



**Slide Dimmer  
(E99-D002-1)**



**Rotary Dimmer  
(E99-D001-1)**



**S35 Right Angle  
2 Pole (spade)  
(S99-0035-1)**



**.156" Bullet Right Angle  
2 Pole  
(S99-0010-1)**



**Straight Tri-pole  
(T99-0010-1)**

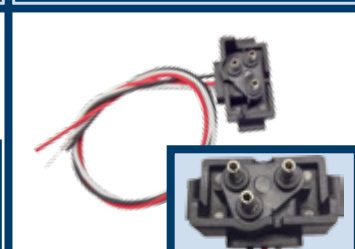

**Right Angle Tri-pole  
(T99-0020-1)**



**Straight  
Amp Connection  
(T99-0040-1)**



**Straight Amp/  
Straight Tri-pole  
(T99-0050-1)**

## Basic Equipment Required on All Trailers

|           | DESCRIPTION                  |                       |                                    |       | MANDATORY REQUIREMENTS |  |   |
|-----------|------------------------------|-----------------------|------------------------------------|-------|------------------------|--|---|
|           | Equipment                    | (SAE Lens Coding)     | Functional Purpose                 | QTY   | Color                  | Location   | Height (in.) From Ground                          |
| <b>1</b>  | Tail Lamps                   | (T)                   | Indicate vehicle presence & width  | Min 2 | Red                    | On the rear - symmetrical - as far apart as practicable            | 15"- 72"  |
|           | Stop Lamps                   | (S)                   | Indicate braking                   | Min 2 | Red                    |  | 15"- 72"  |
|           | Rear Turn Signal Lamps       | (I)                   | Indicate direction of turn         | Min 2 | Red/ Amber             |  | 15"- 83"  |
|           | Rear Reflex Reflectors       | (A)                   | Indicate vehicle presence & width  | Min 2 | Red                    |  | 15"- 60"  |
| <b>2</b>  | License Plate Lamps          | (L)                   | Illuminate license plate           | Min 1 | White                  | On the rear - above or at the sides of license plate               | No requirement                                    |
| <b>3</b>  | Rear Side Marker Lamps       | (P2, PC* or P3, PC2*) | Indicate vehicle presence & length | Min 2 | Red                    | Each side at rear - as far back as practicable                     | 15"- 60"<br>(no max. for vehicles under 80" wide) |
|           | Rear Side Reflex Reflectors  | (A)                   |                                    | Min 2 | Red                    | Each side at rear - as far back as practicable facing sideward     | 15"- 60"  |
| <b>4a</b> | Front Side Marker Lamps      | (P2, PC* or P3, PC2*) | Indicate vehicle presence & length | Min 2 | Amber                  | Each side at front - as far forward as practicable                 | 15" minimum                                       |
| <b>4b</b> | Front Side Reflex Reflectors | (A)                   |                                    | Min 2 | Amber                  | Each side at front - as far forward as practicable facing sideward | 15"- 60"  |

\*Photometrically certified at installation angle

## Length - 30' or longer

|           | DESCRIPTION                         |                   |                                   |       | MANDATORY REQUIREMENTS |   |                          |
|-----------|-------------------------------------|-------------------|-----------------------------------|-------|------------------------|---|--------------------------|
|           | Equipment                           | (SAE Lens Coding) | Functional Purpose                | QTY   | Color                  | Location                                | Height (in.) From Ground |
| <b>5a</b> | Intermediate Side Marker Lamps      | (P2 or P3)        | Indicate presence of long vehicle | Min 2 | Amber                  | Each side near center - Facing Sideward | 15" minimum              |
| <b>5b</b> | Intermediate Side Reflex Reflectors | (A)               | Indicate presence of long vehicle | Min 2 | Amber                  |   | 15"- 60"                 |

## Width - 80" or wider

|          | DESCRIPTION               |                       |   |           | MANDATORY REQUIREMENTS |  |                          |
|----------|---------------------------|-----------------------|---|-----------|------------------------|--|--------------------------|
|          | Equipment                 | (SAE Lens Coding)     | Functional Purpose                                    | QTY       | Color                  | Location   | Height (in.) From Ground |
| <b>6</b> | Rear Clearance Lamps      | (P2, PC* or P3, PC2*) | Shows veh. width- MAY NOT be combined with tail lamps | Min 2     | Red                    | At widest point - symmetrical - on or near the rear - facing Rearward          | 15" minimum              |
| <b>7</b> | Rear Identification Lamps | (P2 or P3)            | Indicate Presence of Long Vehicle                     | Exactly 3 | Red                    | On the rear - center, facing rearward - horizontally spaced 6"- 12" apart      | 15"- 60"                 |
| <b>8</b> | Front Clearance Lamps     | (P2, PC* or P3, PC2*) | Show Vehicle's Width                                  | Min 2     | Amber                  | At widest point - symmetrical - as far forward as practicable - facing forward | As high as practicable   |

\*Photometrically certified at installation angle

**Width - 80" or wider AND GVWR of 10,000 lbs or MORE**

| DESCRIPTION |                         | MANDATORY REQUIREMENTS        |  |                         |  |  |  |
|-------------|-------------------------|-------------------------------|--|-------------------------|--|--|--|
|             | Conspicuity Treatment   | DOT Coding                    | QTY  | Color                   | Location   | Height (in.) From Ground   | Options  |
| <b>9</b>    | Rear Upper Body Marking | DOT-C, DOT-C2, DOT-C3, DOT-C4 | Exactly 2 pairs of 300mm (11.8") long strips | White                   | On the rear upper corners - facing rearward  | At the top   | Rear lower body and side conspicuity treatment may also be solid white, solid amber, or white and amber. |
| <b>10</b>   | Bumper Bar Marking      |                               | Continuous                                   | Red/White               | On the rear bumper bar's horizontal element - full width - facing rearward   | No requirement   |  |
| <b>11</b>   | Rear Lower Body Marking |                               | Continuous                                   | Red/White (see options) | On the rear - full width of the vehicle - facing rearward  | As horizontal and as close to the range of 15"- 60" from ground as practicable |  |
| <b>12</b>   | Side Marking            |                               | see location                                 | Red/White (see options) | Each side - facing sideward - continuous, or evenly spaced over minimum of 50% of length, starts and ends as close to the front and rear of vehicle as practicable |  |  |

- Reflex reflectors may not be required if they are replaced, in their required location, with conspicuity treatment (Optional in Canada).

