

waykar

Commercial Dehumidifier

Please read the manual carefully
before using the unit

DP600B

USER MANUAL

FOR CUSTOMERS

Thank you for purchasing our dehumidifier.

Waykar wishes that our products and services can bring convenience to your work and life. We highly recommend that you keep the manual for reference if you encounter unexpected events using the unit.

Please read the manual carefully to ensure proper use of the dehumidifier. Our dehumidifiers are widely used in family bedrooms, bathrooms, basements, offices and storage rooms, etc.

The dehumidifiers from **Waykar** provide quick and efficient operation to reduce room's humidity and bring you a healthy and comfortable life.

TO ACCESS CUSTOMER SUPPORT FASTER

If there is any problem of the product, please contact Waykar Customer Service at support@waykar.com with your Purchase Order ID to help you address the problem more effectively.

BEFORE FIRST USE:

To prevent any internal damage, it is very important to keep refrigeration units (like this one) upright throughout their journey.

Please leave it standing upright and outside the box for **24 HOURS** before plugging it in.

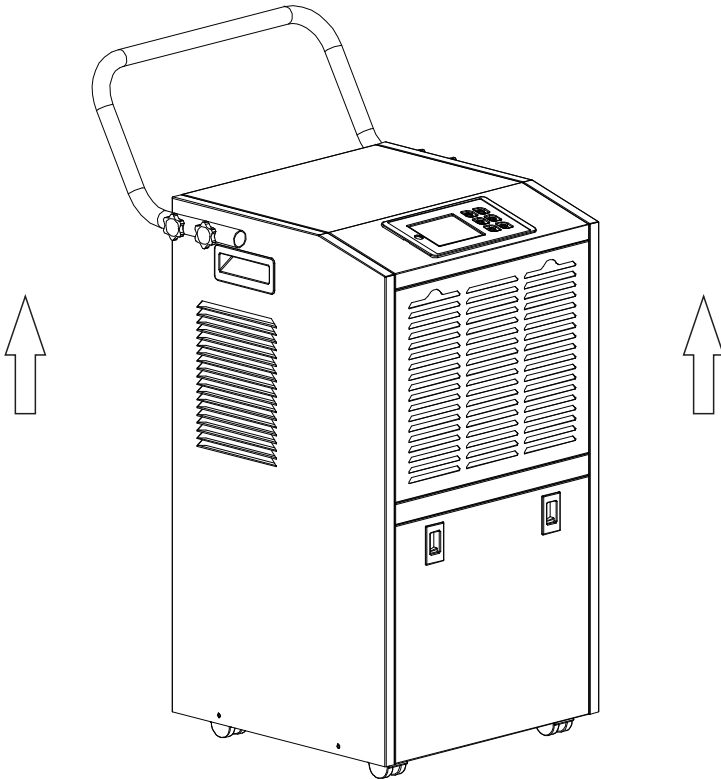

TABLE OF CONTENTS

Safety Instructions.....	01
Parts Description.....	02
Operation Descriptions.....	03
Status Descriptions.....	06
Drainage Description.....	08
Care & Cleaning.....	10
Common Faults & Solutions.....	11
Safety Notes.....	12
Specifications.....	13
Warranty & Contact Us.....	14

Statement

The graphics and functions provided in this manual may not be the same as the actual product. Please always refer to the actual product.

The model of the machine on the manual is for reference only. Please check the corresponding content and operate the machine based on the actual product.

The right to interpret the relevant terms belongs to the company.

SAFETY INSTRUCTIONS

For your safety, please read and keep the manual properly before or after using the unit. Please use the product in accordance with the instructions in this manual.

- Unplug the dehumidifier from the power source when cleaning.
- Do not splash water into the machine or put it near places where it can be splashed.
- Please do not place the machine near a heating device or dangerous inflammable things.
- Do not put your fingers or any hard materials into the air inlet or outlet.
- Do not sit on the unit.
- Drain the water properly (manual or continuous drainage).
- Please make sure that the drain hose is installed on a downward slope so that the water can be drained out properly.
- Do not place the machine on uneven surfaces.
- Do not spray water on this machine.
- Do not spray pesticides or flammable liquid on this machine.
- Do not put or place heavy objects on the machine or place children and pets on the unit.
- Do not place this machine in a confined space.
- If the power cord is damaged, please get a technical staff of the company to replace it. The replacement must be approved.
- When using the laundry mode, please keep 40cm clearance between the clothes and the unit outlet, to avoid the water drips into the dehumidifier and damaging the unit.
- The wiring of the machine must be in accordance with national wiring regulations. The power cord should be connected to a reliable external naught wire.
- The fixed wiring connected to the machine must be equipped with an all-pole disconnect device (air switch) with a contact distance of at least 3mm.
- The specification of the fuse: 5A/250V.
- At least 1m distance shall be kept from the surround objects when using the unit.
- The minimum clearance between the unit and the surrounding may be ensured as the following pictures.

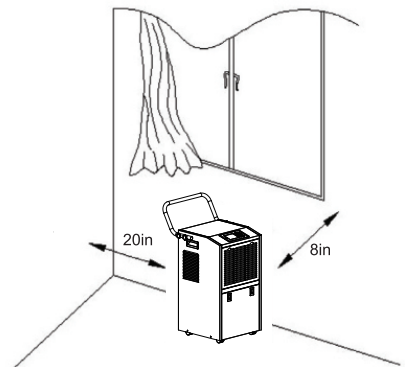

PARTS DESCRIPTION

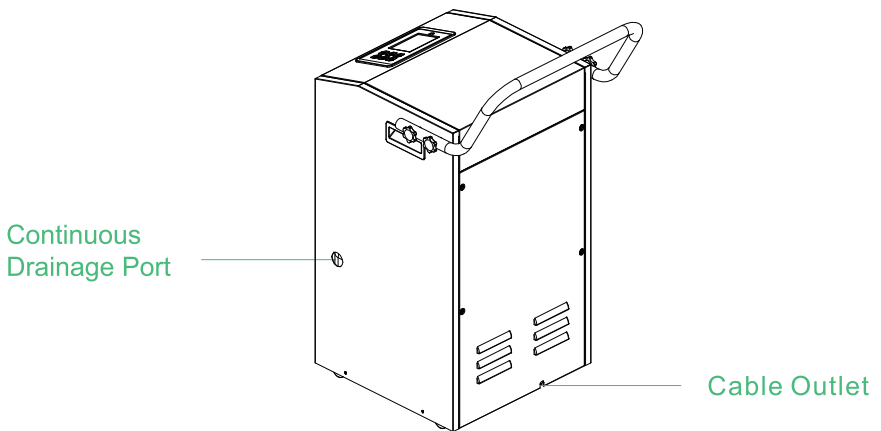
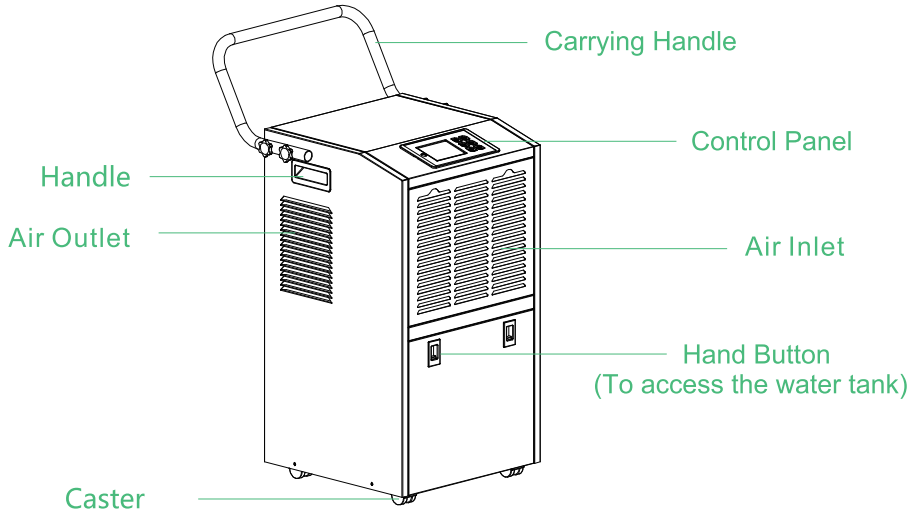

OPERATION DESCRIPTIONS

1. Control Panel

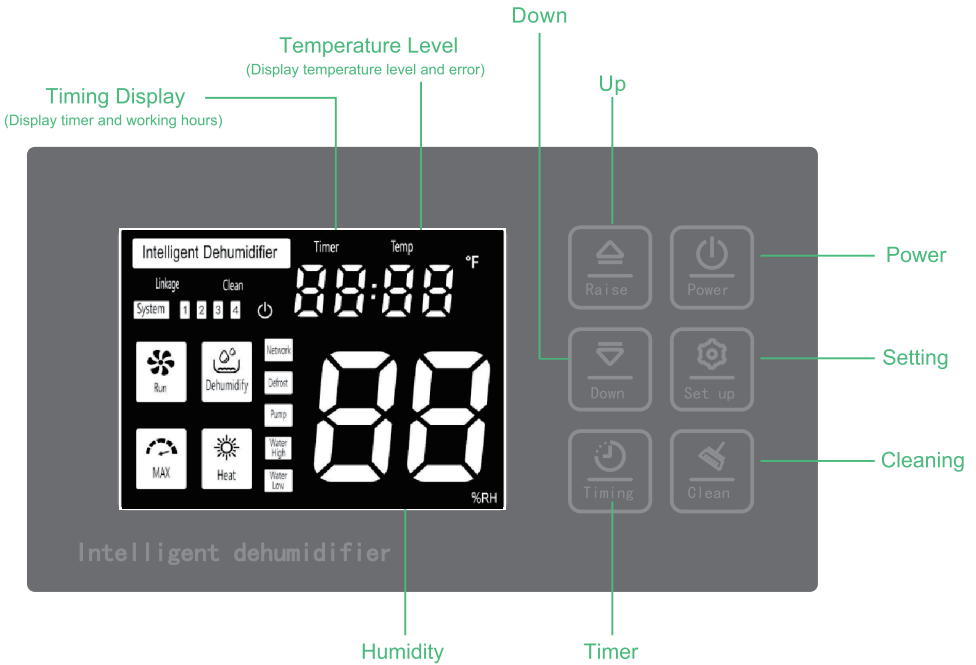



Button Instructions

	<p>Up Button Turn up the parameters including humidity level, timing or cleaning hours.</p>		<p>Power Turn on or off the unit.</p>
	<p>Down Button Turn down the parameters including humidity level, timing or cleaning hours.</p>		<p>Setting Button Set up the humidity, timing hours or cleaning mode, etc.</p>
	<p>Timer Button Turn on or off the timer function or set up the timing hours.</p>		<p>Cleaning Button Turn on or off the cleaning function or set up the cleaning hours.</p>

2. Setting

Power

When the unit is ON, press [POWER] to enable Standby mode. Then the unit stops working and the standby indicator  turns on.

When the unit is OFF, press [POWER] to turn on the unit. Then the unit starts working and the standby indicator  turns off.

Humidity Setting

When the unit is ON, press [Up] or [Down] to enter the humidity setting. The humidity display %RH flashes and humidity "88" flashes to show the level. Press [Setting] again or wait for a while, to exit the setting.

When setting the humidity, press [Up] or [Down] to adjust the humidity level between 10-90%RH (noncycle setting). Press [Up] once to increase 1%RH of the humidity level, while press [Down] once to decrease 1%RH of the humidity level. Hold the buttons to continuously increase/decrease the level. When setting finished, press the [Setting] once or wait for seconds to exit the humidity setting.

Timer Setting

If setting up the timer in OFF mode, then it's the power-on delay. If setting up the timer in ON mode, then it's power-off delay. But if the timing hour is 00h, the setting will be invalid.

When the dehumidifier is on, press [Timer] button to enter timing setting. The timer icon lights on, and the number "88" flashes and shows the remaining working hours. Press [Timer] again or wait for seconds to exit the setting. In the timer setting, press [Up] or [Down] to adjust the timing hours between 00-24 (noncycle setting). Press [Up] once to increase one hour while decrease one hour with button [Down]. Hold the buttons to continuously increase/decrease the hours. When setting finished, press [Setting] once or wait for seconds to exit the timer setting.

Continuous Dehumidifying

Set up the humidity level at 10% RH, and the unit will enter continuous dehumidifying mode (the icon  lights). The dehumidifying is not affected by the humidity level has been set before.

Cleaning Setting

- Cleaning Time Setting

When the unit is on, hold the button [Cleaning] to enter cleaning setting. The icon Cleaning lights up, and the number "88" displays the cleaning days. Press the button once again or wait for seconds to exit the setting.

In the cleaning setting, press [Up] or [Down] to adjust the cleaning time between 01-99 days (noncycle setting). Press [Up] once to increase 1 day while decreasing 1 day by pressing [Down] once. Hold the buttons to continuous increase/decrease the days. When setting finished, press button [Setting] once or wait for seconds to exit the setting.

- Check Running Time

When the unit is OFF, hold the button [Cleaning] to check the cleaning status (the total working time of the dehumidifier). The time will be shown in the timer and humidity displays. Press the ON/OFF button once again or wait for seconds to exit the setting.

- Reset Running Time

In the cleaning query mode, press [Setting] once to reset the total cleaning running time (total working time of the fan).

STATUS DESCRIPTIONS

1. Unit Working Description

The compressor and fan will stop working successively when turn off the dehumidifier.

The compressor will stop working immediately, and the fan stops working later, whenever the High/Low-Temperature Protection is triggered, the humidity level set before is reached, or breakdown occurs.



Compressor 3 Minutes Delay Protection: After the unit has stopped, it can not be restarted in the first 3 minutes to protect compressor operation. The unit will restart automatically after 3 minutes.



Parameter Memory Function : If the unit stops unexpectedly due to a power cut, it will restart with the previous function setting such as Cleaning time setting, Humidity level or Power On/OFF status.

2. Indicator Descriptions

The icon  turns off, while the indicator Smart Dehumidifying lights up when turning on the unit.

The icon  light on, while the indicator Smart Dehumidifying turns off when turning off the unit.

The icon  flashes when the fan starts working in time-delay; the icon  lights on when the fan start working; the icon  turns off when the fan stops working.

The icon  flashes when the compressor starts working in time-delay; the icon  lights on when the compressor starts working; the icon  turns off when the compressor stops working (Defrost status).

When the ambient humidity level reaches the humidity level set before, the compressor stops working. Then the icon  and humidity meter flash simultaneously.

When the cleaning level is reached, the indicator  lights up. When the status is dismissed, the indicator turns off.

When the unit enters into high-temperature protection mode, the humidity display flashes and reads **-H**.

When the unit enters into low-temperature protection mode, the humidity display flashes and reads **-L**.

When the unit is in defrost mode, the icon  lights up;

when the unit exits defrost mode, the icon  turns off.

3.Error&protection Code

Number	Error Code	Handling Method
1	E1	Change the sensor and connecting cable of the RHI-112A port.
2	E2	Change the temperature sensor of PTI port.
3	E3	Make sure the water tank is well placed, and the WF port is properly connected.
4	E4	Change the sensor and connecting cable of the RHI-112A port.
5	E6	Make sure the display circuit has been connected right, and the DISPLAY port is well connected.
6	-H	No problem. The unit resumes working when unit temperature goes down.
7	-L	No problem. The unit resumes working when unit temperature goes up.

Note

1. If problems were not solved, please unplug the unit and send the unit back for repairment.
2. When the unit shows E1,E2, E4 error codes, it can still work. But some function are disabled.

If the malfunction is still present, please don't hesitate to contact Waykar Customer Service email at support@waykar.com.

DRAINAGE DESCRIPTION

1. Drainage Description

Two ways are available to remove the collected water.

Water Tank Drainage

When the full tank indicator flashes, press the two locks at front side simultaneously (see picture 1) to open the panel. Then refer to picture 2 to remove the bucket and empty the water. Put the water tank back into place and fix the cover when emptying the bucket.

Ways to Empty the Water Tank

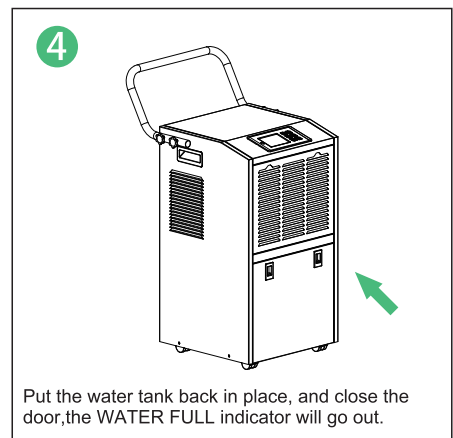
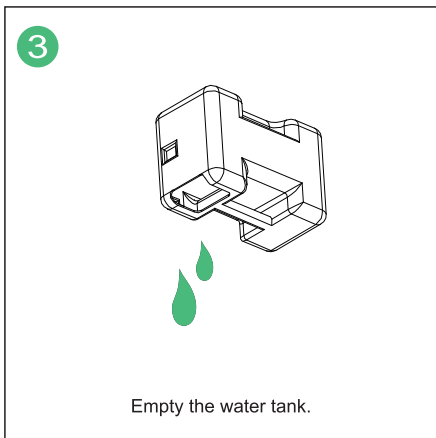
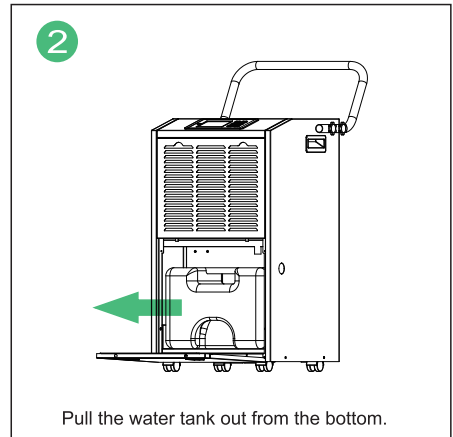
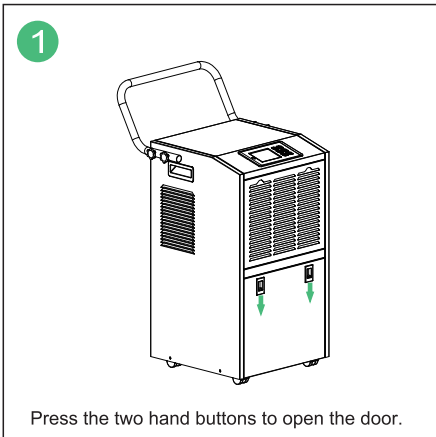

DRAINAGE DESCRIPTION

2. Continuous Drainage

For continuous draining, you need to press the two locks at front side simultaneously (see picture 1) to open the panel. Then refer to picture 3 to connect a drain hose (inner diameter 16mm) to drain the water.

Note:

1. Fix the hose into the groove to avoid fall-off, and cause water leakage.
2. The water tank must be placed inside the unit for using the continuous drainage, or the unit may fail to work.

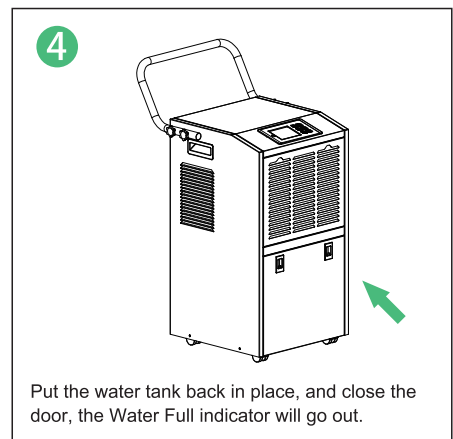
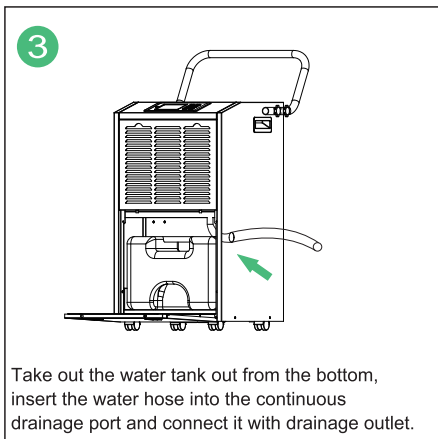
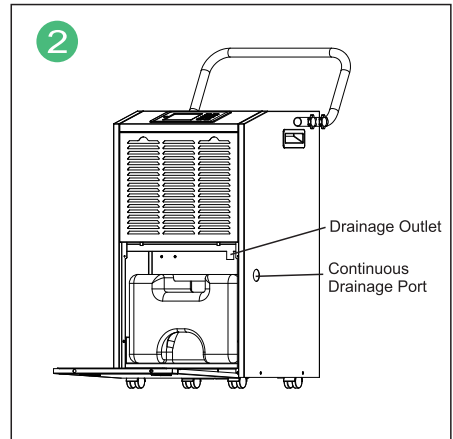
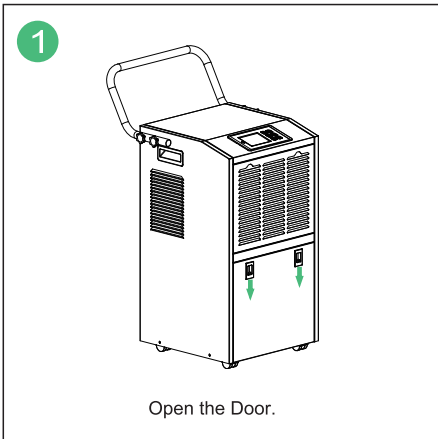

CARE & CLEANING

▲ WARNING:

Turn the dehumidifier off and remove the plug from the wall outlet before cleaning.

A. Housing Washing

Do not use volatile chemicals, gasoline, detergent, or other related detergents to clean the exterior, for they may damage the coating to accurate the corrosion.

B. Filter Cleaning

It's advised to clean the filter regularly and properly. Make sure clean the filter at least once a month. Clean the unit thoroughly before idling the unit for long time, to prevent bacteria and mould breed.

1. Remove the inlet panel and get the filter out.
2. Clean the dust on the surface with the vacuum or flush and wash the filter with detergent and place it at somewhere ventilated. Do not expose the filter to strong sunshine or dry the filter with high temperature, or the filter may be distorted.
3. Place the filter back first and then the inlet panel back into place.

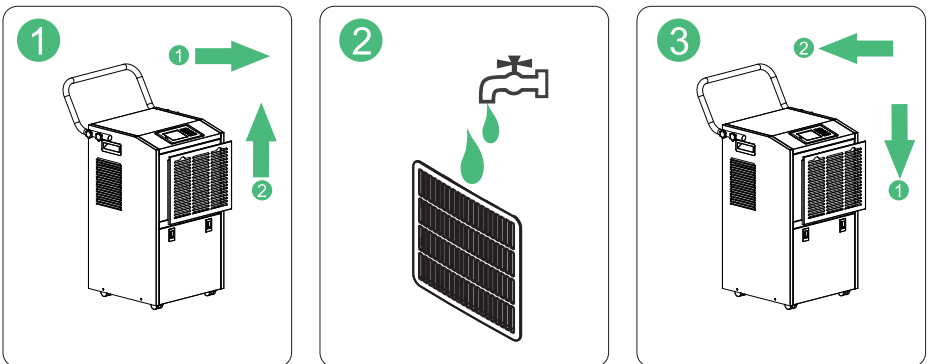

When the breakdown and problems occurs on the dehumidifier, please refer to the Troubleshooting part in the manual. Do not dismantle or repair the unit yourself, for improper repair may cause danger.

COMMON FAULTS & SOLUTIONS

Check the information below for troubleshooting steps, it will save you time to resolve issues that may happen with the unit.

The list includes most of the common cases, but not the results of defective unit, crafts or materials in the unit.

If all troubleshooting steps have been exhausted and the issue is still occurring, please feel free to reach out to Waykar Customer Service to get further assistance.

Problems	Analysis	Solutions
Not working	Dark Display	Check the power cord socket and the wiring.
	Defrost icon lights up?	Defrost function running, and the light will resume after working.
	“ -H ” icon lights up	The unit shall not used in high-temperature conditions.
	“ -L ” icon lights up	The unit shall not used in low-temperature conditions.
Much Noise	The unit is place at uneven surface.	Place the unit at somewhere flat and even.
	The filter may be blocked.	Refer to the Care and Cleaning part to clean the filter.
	The inlet or outlet may be blocked.	Keep the unit inlet or outlet away from objects.

Warning

If the dehumidifier is still not working properly as expected and the troubleshooting steps or solutions above may not resolve the issue, please unplug the power and shut down the dehumidifier, then contact Waykar Customer Service at support@waykar.com.

SAFETY NOTES



- 1 When using, please do not put the machine at the soft and uneven ground, avoid vibration and movement.

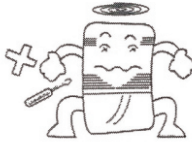

- 2 Do not insert thin rods and hard objects into the machine body to avoid malfunction and danger.

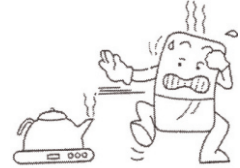

- 3 When using, please keep the machine away from heating furnace, electric kettle and other heat sources.



- 4 When using, please close doors and windows to achieve the best remove humidity effect.

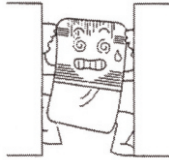

- 5 Please do not put objects around the body. If the ventilation is blocked, the dehumidification effect will be affected.



- 6 If do not use the product for a long time, please unplug the power cord.



- 7 When cleaning the dehumidifier, please use the wet textile to wipe gently, do not shoot the water directly.



- 8 Please do not put any object on the dehumidifier.



- 9 Please clean the filter every two weeks (do not use hot water above 104°F, alcohol, gasoline or toluene.)

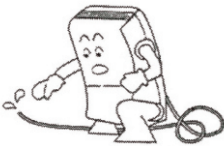

- 10 When continuous drainage, the drain hose must be placed horizontally, without unevenness and winding.



- 11 After cleaning the filter, please do not dry it under direct sunlight, in case deformation.



- 12 Before moving and carrying the machine, please first pour out the water in the tank.

SPECIFICATIONS

MODEL	DP600B
POWER SOURCE	115V~60Hz
TOTAL INPUT CURRENT	7.9A
MOISTURE REMOVAL (65°F/60%RH)	48.5 Pints/Day (23L/Day)
MOISTURE REMOVAL (80°F/60%RH)	74 Pints/Day (35L/Day)
MOISTURE REMOVAL (86°F/80%RH)	123 Pints/Day (58L/Day)
MOISTURE REMOVAL (95°F/90%RH)	155 Pints/Day (73L/Day)
INPUT POWER (65°F/60%RH)	500W
INPUT CURRENT (65°F/60%RH)	5.4A
IEF (65°F/60%RH)	1.92 liters/kWh
MOTOR FLA	0.76A
MOTOR COMPRESSOR (RLA/LRA)	RLA:6.4A LRA:30A
REFRIGERANT	R410a/450g
MAXIMUM ALLOWABLE PRESSURE	5.5MPa (800 PSIG)
HIGH PRESSURE	4.0MPa (580 PSIG)
LOW PRESSURE	1.7MPa (247 PSIG)

Working temperature of this product ranges from 41°F(5°C) to 100°F(38°C). In any case of the room temperature exceeds this range, the machine can not work properly.

The parameters above are subject to modification by the company without further notice.

 **WARNING:**

This product can expose you to chemicals including Styrene and its compounds, which is known to the State of California to cause cancer and birth defects or other reproductive harm. For more information go to: www.P65Warnings.ca.gov

Warranty

Waykar offers a 12-month warranty to all of our products together with the original proof of purchase when a defect occurred, including those newly purchased and unused, from Waykar or through an authorized reseller, wholly or substantially, or as a result of faulty manufacturing parts, or workmanship during the Warranty Period.

The warranty does not apply if damage is caused by other factors, including but without limitation of:

- (a) Normal wear and tear;
- (b) Abuse, mishandling, accident or failure to follow operating instructions;
- (c) Exposure to liquid or infiltration of foreign particles;
- (d) Servicing or modification of the product other than by Waykar.

There are our general terms for the warranty service, but we always encourage our customers to contact us if any issues, regardless of warranty terms. If you are experiencing an issue with Waykar product, you can reach out to us at support@waykar.com, we will dedicate our efforts to resolve it for you.

Extend Your Warranty by 1 Year

Register your product at www.waykar.com to extend your 1-year warranty by an additional year.

*Please fill out all required fields and include your Order ID, Date of Purchased if applicable.

Customer Support

If you have any questions or concerns about your product, please feel free to contact our expert support team. Waykar customer service is here to help.

Waykar Office

13211, Spring Street Baldwin Park, CA, US

Email: support@waykar.com

Live Chat: www.waykar.com

Support Hours

24 Hours available

*Please have your Order Number ready before contacting customer support.

waykar

For FAQs and more information please visit:
www.waykar.com



@Waykar



@Waykar



@Waykar



@Waykar



(Scan the QR Code for Live Chat)

We are expecting to see our products fulfill your life and hear your voice.

Your satisfaction means a lot to us.

Please tag us if you share a snap on your social media.

www.waykar.com