

# waykar

## Commercial Dehumidifier

Please read the manual carefully  
before using the unit

**PD606B**

USER MANUAL

## FOR CUSTOMERS

Thank you for purchasing our dehumidifier.

**Waykar** wishes that our products and services can bring convenience to your work and life. We highly recommend that you keep the manual for reference if you encounter unexpected events using the unit.

Please read the manual carefully to ensure proper use of the dehumidifier. Our dehumidifiers are widely used in family bedrooms, bathrooms, basements, offices and storage rooms, etc.

The dehumidifiers from **Waykar** provide quick and efficient operation to reduce room's humidity and bring you a healthy and comfortable life.

## TO ACCESS CUSTOMER SUPPORT FASTER

If there is any problem of the product, please contact Waykar Customer Service at [support@waykar.com](mailto:support@waykar.com) with your Purchase Order ID to help you address the problem more effectively.

# BEFORE FIRST USE:

To prevent any internal damage, it is very important to keep refrigeration units (like this one) upright throughout their journey.

Please leave it standing upright and outside the box for **24 HOURS** before plugging it in.

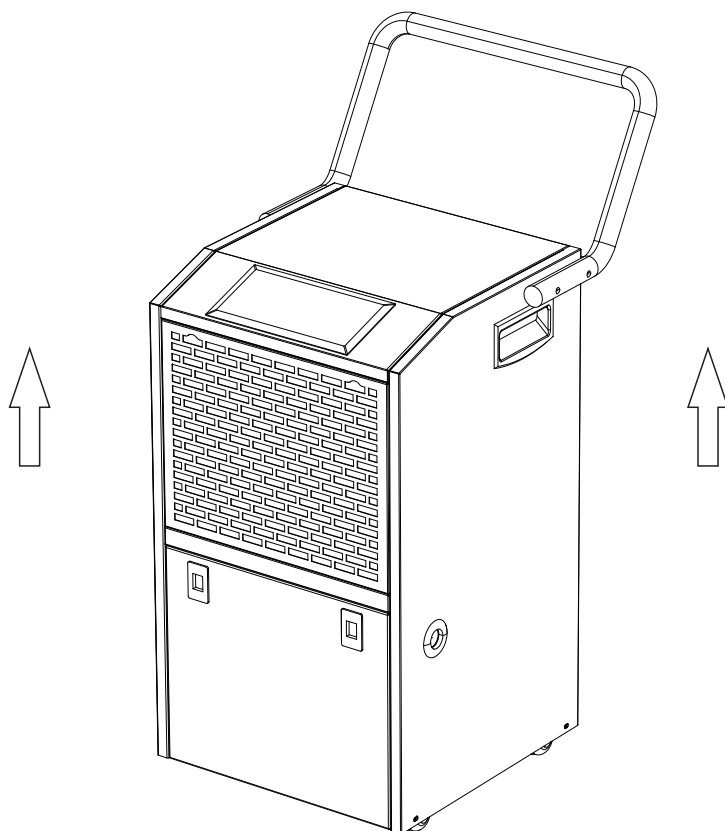

# CATALOG

Safety Instructions.....	01
Parts Description .....	02
Control Interface .....	03
Operation Instructions.....	04
Cleaning & Maintenance.....	10
Common Faults & Solutions.....	11
Special Notes .....	13
Technical Parameters.....	15
Warranty&Contact Us.....	16

## Statement

The graphics and functions provided in this manual may not be the same as the actual product. Please always refer to the actual product.

The model of the machine on the manual is for reference only. Please check the corresponding content and operate the machine based on the actual product.

The right to interpret the relevant terms belongs to the company.

# SAFETY INSTRUCTIONS

## Safety Notes:

Before installation, operation and maintenance of this machine, please read the safety precautions carefully.

Remove the packing materials of the device, keep far away from kids or baby to avoid the risk of suffocation.

Before plug in the machine, ensure the voltage is within the range of label.

This dehumidifier is only used for the specified applications.

The manufacturer shall not take any responsibility for the damage caused by the improper application.

This device is safe in application, but careful operation is required as operating other electric appliances.

Please place the machine vertically for two hours prior to power on the machine in the 1st time application.

Do not insert fingers or other objects into the air outlet.

This appliance should not be used under the environment below 41°F.

Special Note: When the display screen does not light up, it does not mean the power has been disconnected.

## Cautions!

- The unit shall be installed in accordance with national wiring regulations.
- Model specification of safety tube: 5A.
- This unit should be operated between the temperature of 41°F and 100°F. If over this range, the machine may not work properly.
- When using this dehumidifier, other objects surrounding the machine at least need to kept at a distance 39.4 inches (1m).
- Please adopt the 110-120V-60Hz grounding socket.
- The installation and use of this machine must be in accordance with local regulations and rules.
- If you have any questions about the installation of this product, please learn more from the user manual or refer to the professionals.
- Draw out the plug when do not use. Never remove the plug by pulling the wire. Never operate the machine with wet hands.
- Please keep this machine in the places will not be played with by the children.
- Never soak the machine in water or spray any water on the machine when cleaning.
- Please make sure to remove the plug when cleaning or maintaining the machine.
- Do not use the extension cable to connect with power, ask the professionals for installation when there are no proper sockets available.
- To avoid the occurrence of danger, ask manufacturer, agents or qualified staff for replacement of damaged power wire.

# PARTS DESCRIPTION

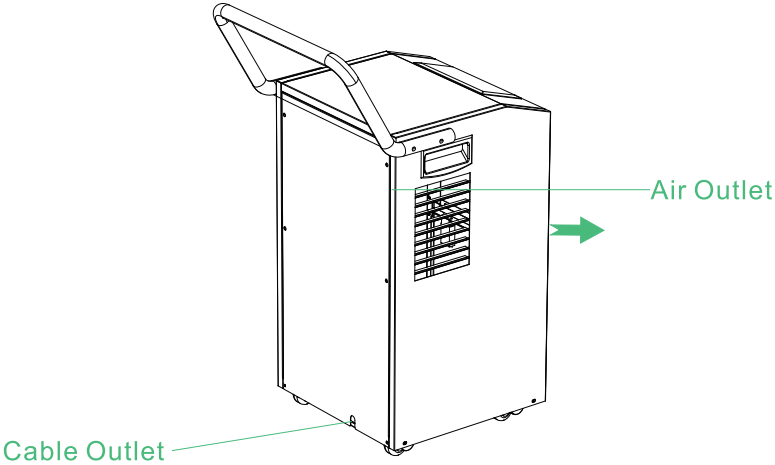
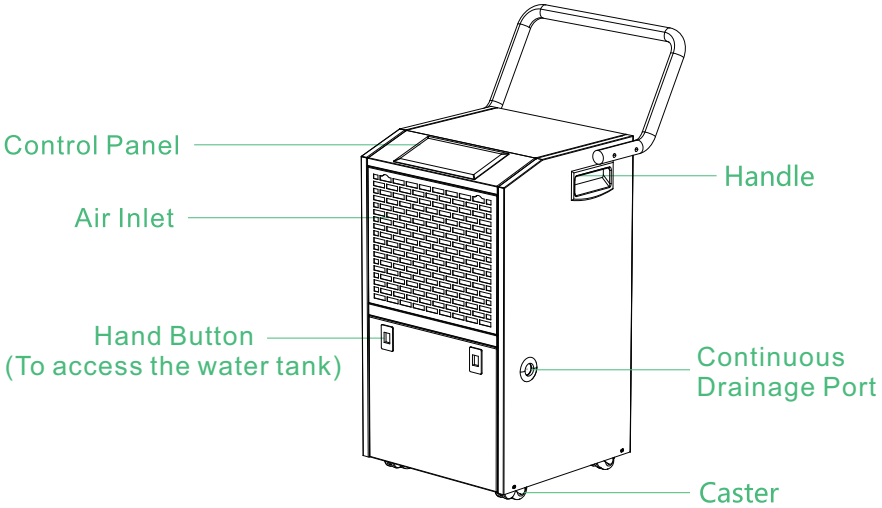

## 1. Control Panel

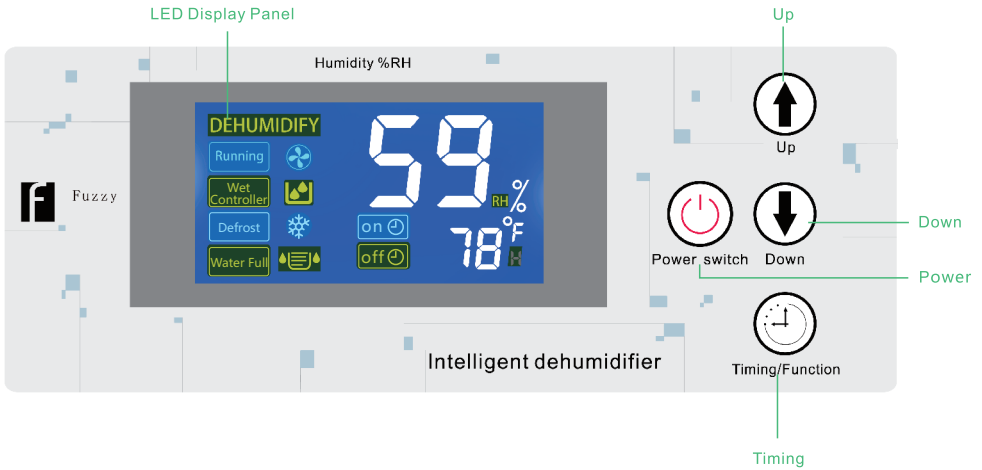

### Button Instructions



#### Up Button

Set the humidity down



#### Power Button

Press to turn on or turn off the machine



#### Down Button

Set the humidity up



#### Function Button

Confirm the setting



#### Timer Button

Press to initiate the auto-start or auto-stop feature.

## 2. Setting

### Setting Humidity

- In power-on status, you can press Up/Down button to set the humidity range between 10%-98%RH.
- When it starts to work, the machine will first automatically detect and show the room's humidity. You can press "Up" button to change the humidity selection in 1%RH increment or press "Down" button to change the humidity selection by 1%RH decrement.
- The big number "88" will flash to show the setting value during this process.
- Press the "Function" button once or no operations for seconds, the machine will exit the function setting automatically and display the current humidity.

### Timing Setting

This timer setting function is designed for you to set a time to turn off (when the machine is on) or to turn on (when the machine is off) the machine, automatically by the timer.

In power-on or power-off status, long press the "Timing" button to enter timer setting status, the timer icon "  " and "h" will light up, the small number will flash to show the setting time.

You can press "Up" or "Down" button to set the timer within 1-24 hours by 1-hour increment or decrement, which can be reset again after invalid.

Press and hold the "Timing" button for several seconds, it can be set continuously.

If no timer setting, the small number on the screen will display the current temperature. If the timer being set successfully, the small number will display the remaining time, and if you press the "Timing" button again, the small number will return to the remaining time automatically after a few seconds.

If the timer is set to "00", this is called the invalid time.



## Power off Memory Function

- After the device is powered on, it will automatically resume the working status before power off.
- If the machine is running before power outage, the machine will automatically enter power-on status, and maintain the previous setting parameters.
- If the machine is shut down before the power outage, then the machine will still be in power-off status.

## Defrost Function

When the dehumidifier is running at a lower temperature, the system will automatically determine whether there is a presence of frost. If any frost exists, it will defrost automatically.

The fan will keep running and the compressor will stop when defrosting. After this process, the compressor will restart to run.

## Temperature Protection Function

When the ambient temperature is higher than the default high temperature of 113°F, the system will enter high temperature protection, the small number will indicate "HH", and the compressor will stop;

When the ambient temperature is lower than the default low temperature of 39 °F, the system will enter the low temperature protection, the small number will indicate "LL", and the whole machine will stop.

## Cleaning Remind Function



When the accumulative running time of the fan is  $\geq 30$  days, the machine can continue to run, but it will prompt "  " and it will not be able to be removed even restarted.



In power-off status, long press the "Function" button for seconds, then the display screen will show once, the "  " prompt will be released, and the fan running time will be cleared.

## Special Note :

To avoid any damage to the dehumidifier, the compressor features a "3 minutes delay protection" function, which is, when the dehumidifier is powered, the compressor can only start again 3 minutes later after its last shutdown.

## 3. Display Status Description

When the fan is delayed, the running icon "**Running**  " will flash, and if the fan is running, the running icon "**Running**  " will be on, otherwise it will be off.

When the compressor is delayed, the dehumidification icon "  " will flash, and if the compressor is running, the dehumidification "  " icon will be on, otherwise it will be off.

If the ambient humidity is lower than the setting humidity, the compressor will be stopped, and the humidity control icon "**Wet Controller**" will flash, otherwise it will be off.

When the machine needs to be cleaned, the cleaning icon "  " will flash, otherwise it is off.

When the machine is defrosting, the defrost icon "**Defrost**  " will flash, and go out when the defrosting ends.

## 4. Error & protection Code

Number	Error Code	Name of The Fault
1	E0	Malfunction of defrosting temperature sensor 2
2	E1	Malfunction of humidity sensor
3	E2	Malfunction of defrosting temperature sensor 1
4	E3	Malfunction of phase sequence (not applicable for this model)
5	E4	Malfunction of environmental temperature sensor
6	E5	Malfunction of system high pressure
7	E6	Malfunction of system low pressure
8	E7	Alarm for full water
9	E8	Malfunction of overloading current of compressor
10	E9	Malfunction of overload current of compressor
11	ER (EA)	Defrost temperature sensor 3 failure
12	Eb (Eb)	Defrost temperature sensor 4 failure
13	Ec (Ec)	Display information transmission abnormal

### Note

1. If E0, E1, E2, E3, E4, ER or Eb occurs, the compressor and fan still work, and can be restarted when power supplied (press any button can release the alarm).
2. If E3, E5, E6, E8 or E9 alarms, the machine needs to be cut off the power supply to restart after troubleshooting.
3. When Ec occurs, the operation of the machine will not be controlled.

If the malfunction is still present, please don't hesitate to contact Waykar Customer Service email at [support@waykar.com](mailto:support@waykar.com) for help.

## 5. Empty the Water Tank

Two ways are available to remove the collected water.

### Use The Water Tank

When the water tank is already full, the "**WATER FULL** " indicator will light up, the dehumidifier will automatically shut down until the tank has been emptied and placed back to the unit.

### Ways to Empty the Water Tank

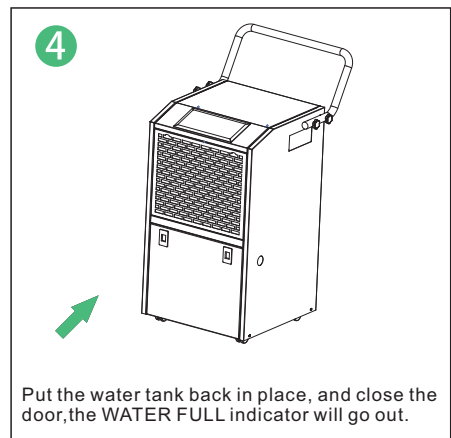
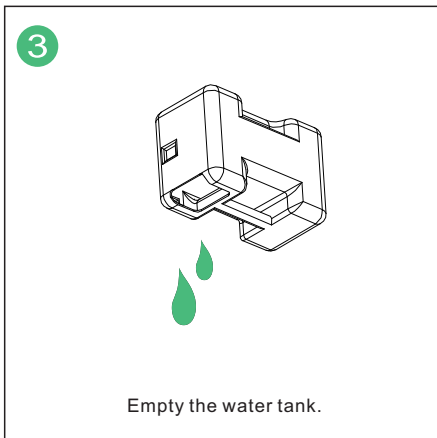
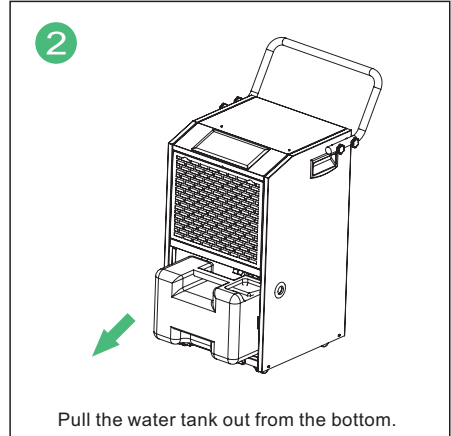
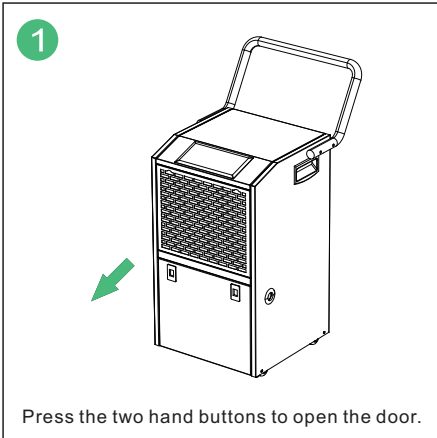

# OPERATION INSTRUCTIONS

## 6. Continuous Drainage

Pull out the power supply, open the door, take out the water tank, insert the water hose into the continuous drainage port, connect it with drainage outlet and put back the water tank.

Power the machine again to start the operation. The outlet of the water hose should be lower than the continuous drainage port by more than 6 inches, and the hose can not be bent during the drainage process, or the water will be blocked and can not flow out.

(Note: The diameter of continuous drainage port is 0.63 inches. )

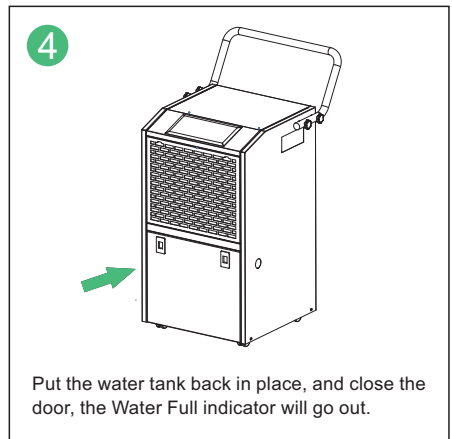
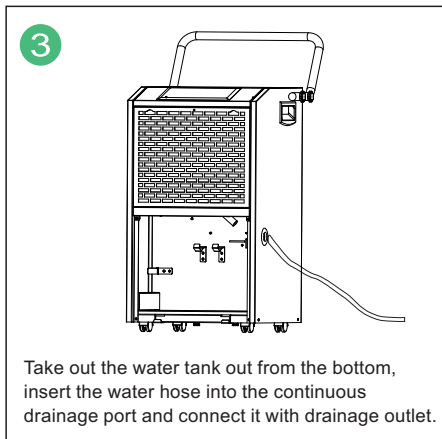
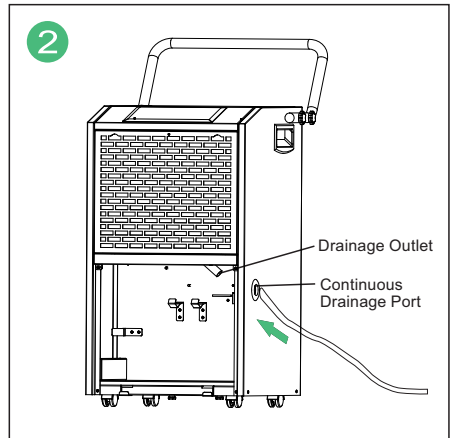
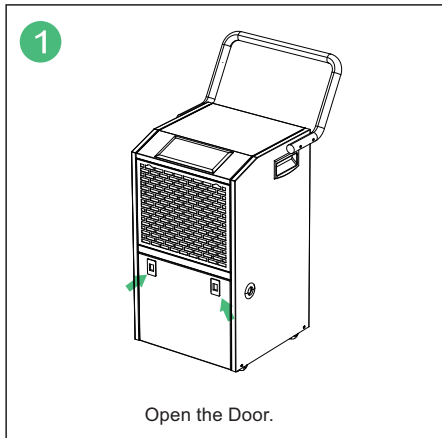

# OPERATION INSTRUCTIONS

## ⚠ WARNING:

Turn the dehumidifier off and remove the plug from the wall outlet before cleaning.

## A-Cleaning the dehumidifier body

Please use a soft and a slightly wet textile or cloth to clean it.

## B-Cleaning filter

1. Pull out the filter
2. Clean the filter: Use a vacuum cleaner to gently remove the dust from the surface of the filter. If the filter is very dirty, clean it with warm water and mild detergent and dry it completely.
3. Slowly insert the filter back into the machine body.

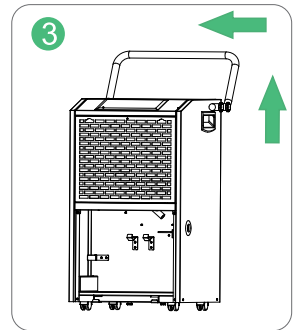
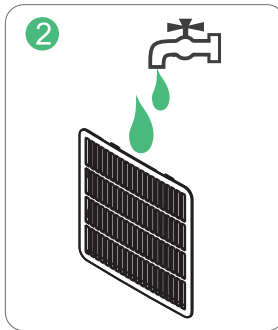
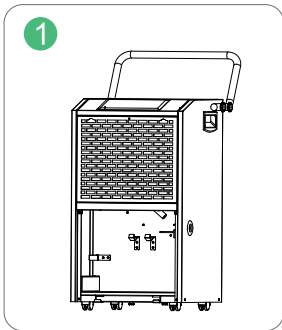

## C-dehumidifier storage

When you want to store the dehumidifier, you don't use it for a long time. Please pay attention to the following steps:

1. Empty the water in the water tank.
2. Roll up the power cord and tie it up.
3. Clean the filter.
4. Place the machine in a cool and dry environment.

# COMMON FAULTS & SOLUTIONS

Check the information below for troubleshooting steps, it will save you time to resolve issues that may happen with the unit.

The list includes most of the common cases, but not the results of defective unit, crafts or materials in the unit.

If all troubleshooting steps have been exhausted and the issue is still occurring, please feel free to reach out to Waykar Customer Service to get further assistance.

Problem	Reason	Method
Dehumidifier does not work	Is the power cord connected properly?	Make sure that the unit's plug is inserted properly into the power outlet.
	Water tank is not placed in a proper position	Pull out the water tank and put it back properly in the machine and make sure the tank is empty.
	Room temperature is too high or too low: above 95°F or below 41°F.	This product does not apply to over hot or cold environment, the machine will automatically enter the protection mode in this condition.
	Room temperature is between 41°F(5°C) and 68°F (20°C)	The machine will automatically defrost when running under lower ambient temperature, which is a normal phenomenon. It will restart dehumidification again until the defrosting process finished.
	Is the ambient humidity lower or reaching the preset humidity level? (When the room humidity has reached or lower than the preset level, the dehumidifier will enter the Standby Mode)	Please set the humidity by 5%RH lower than the room humidity or set the humidity to 30%RH.
	This is to prevent the frequent start of the machine. Does the machine stop working just now?	Please wait for more than 3 minutes.

# COMMON FAULTS & SOLUTIONS

Poor dehumidification efficiency	The air filter is dirty.	Clean the air filter.
	Is the air inlet or air outlet obstructed?	Remove the obstruction from the air inlet or outlet.
	The dehumidifier size is too small for application.	Increase the quantity of dehumidifier. Or change to a higher capacity dehumidifier.
	Poor air circulation.	Please leave about 20cm (7.9 inches) around the product.
	Do not allow enough time to remove the moisture.	Allow enough time to remove the moisture. When first installed, allow at least 3-4 days to maintain the desired RH.
	The room has not been sealed properly.	Check that all doors, windows and other openings are securely closed.
	Room temperature is too low, or below 41°F (5°C): The machine will not work or undergo poor dehumidifying efficiency in low temperature.	Please wait until the temperature rises to above 5°C or higher.
The dehumidifier makes a loud noise when operating	Is the machine tilted?	Move the machine to a horizontal position.
	Is the air intake or outlet being blocked?	Clean up the dirt or lint on the air outlet and intake.
	Is the filter installed correctly?	Please check whether the packing bag of the filter had been removed and the filter has been installed correctly.

## Warning

If the dehumidifier is still not working properly as expected and the troubleshooting steps or solutions above may not resolve the issue, please unplug the power and shut down the dehumidifier, then contact Waykar Customer Service at [support@waykar.com](mailto:support@waykar.com).



# SAFETY NOTES

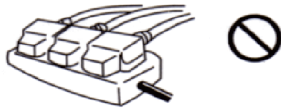

Do not use overall relay, extension cable or adapter to connect this device. Wrong application could cause fire, electric shock or heating.

Do not place this device close to furnace, heater and devices that could produce heat. Wrong application could cause resin melt and even fire.

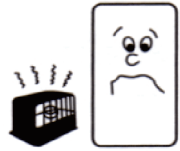

Do not use the machine in the area that is subject to direct sunlight, wind or rain, indoor application only.

Turn off the machine and remove the power wire when problem happens (e.g. the machine emits a smell of burning.). Wrong application could result in fire, electric shock and new failure.



Do not use the machine in the area that could be affected by chemical. The medicine or solvent permeated into air could cause bad influence to the device and cause leakage of water in the tank.

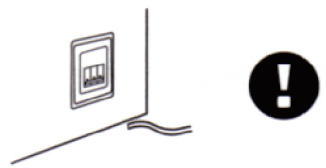

Remove the power cable when do not use the machine for a long time.



Turn off the machine and remove the power cable when cleaning the machine. Improper operation could cause personal injury.

Place the drainage hose well when drain water continuously so as to flow the water freely. If work in a cold temperature that could freeze the water, then the continuous drainage may not be applicable.

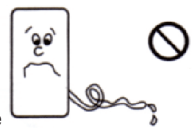

# SAFETY NOTES



Do not repair, disassemble or modify this machine through do-it-yourself. Wrong application could cause fire or accident of electric shock.

Place this machine on a stable site or platform. If the device is tip over, the water inside could leak, which damages the surrounding items and cause electric leakage, fire or electric shock.



The way to extend the application life of air purification filter screen is to place the filter into a plastic bag, before you seal and store when do not use the device for a long time.

Do not use the machine in the area that is adjacent to water, as electric leakage could happen when this machine encounters water and will cause fire or electric shock.



Please apply proper power switch, wrong application could cause fire or electric shock.



Do not damage or alter power cable. Please do not place heavy item on the power cable, heat or drag the power cable with force, or it could damage the power cable and cause fire or electric shock.



Please connect the power cable with the switch securely. Looseness of power cable could pose a safety risk of electric shock.



Do not pull the power cable to stop the operation of the machine. Wrong application could cause fire or electric shock.

## TECNICAL PARAMETERS

MODEL	D606B
POWER SOURCE	120V-60Hz
RATED POWER	1000W
RATED CURRENT	8.8A
MOISTURE REMOVAL CAPACITY (65°F/60%RH)	47 Pints/Day
MOISTURE REMOVAL (80°F/60% RH)	75 Pints/Day
MOISTURE REMOVAL (86°F/80% RH)	126 Pints/Day
MOISTURE REMOVAL (95°F/90% RH)	155 Pints/Day
INPUT POWER(65°F/60% RH)	515W
INPUT CURRENT(65°F/60% RH)	4.6A
IEF(65°F/60% RH)	1.80liters/kWh
MOTOR FLA	0.85A
MOTOR COMPRESSOR	RLA: 10A LRA: 30A
PEFRIGERANT	R410A/450g (15.87ozs)
MAXLMUM ALLOWABLE PRESSURE	5.5MPa
MAXLMUM OPERATING PRESSURE HIGH	4.0MPa
MAXLMUM OPERATING PRESSURE LOW	1.7MPa



### WARNING:

This product can expose you to chemicals including Styrene and its compounds, which is known to the State of California to cause cancer and birth defects or other reproductive harm. For more information go to: [www.P65Warnings.ca.gov](http://www.P65Warnings.ca.gov)

## Warranty

---

Waykar offers a 12-month warranty to all of our products together with the original proof of purchase when a defect occurred, including those newly purchased and unused, from Waykar or through an authorized reseller, wholly or substantially, or as a result of faulty manufacturing parts, or workmanship during the Warranty Period.

The warranty does not apply if damage is caused by other factors, including but without limitation of:

- (a) Normal wear and tear;
- (b) Abuse, mishandling, accident or failure to follow operating instructions;
- (c) Exposure to liquid or infiltration of foreign particles;
- (d) Servicing or modification of the product other than by Waykar.

There are our general terms for the warranty service, but we always encourage our customers to contact us if any issues, regardless of warranty terms. If you are experiencing an issue with Waykar product, you can reach out to us at [support@waykar.com](mailto:support@waykar.com), we will dedicate our efforts to resolve it for you.

## Extend Your Warranty by 1 Year

---

Register your product at [www.waykar.com](http://www.waykar.com) to extend your 1-year warranty by an additional year.

\*Please fill out all required fields and include your Order ID, Date of Purchased if applicable.

## Customer Support

---

If you have any questions or concerns about your product, please feel free to contact our expert support team. Waykar customer service is here to help.

### Waykar Office

13211, Spring Street Baldwin Park, CA, US

Email: [support@waykar.com](mailto:support@waykar.com)

Live Chat: [www.waykar.com](http://www.waykar.com)

### Support Hours

24 Hours available

\*Please have your Order Number ready before contacting customer support.



# waykar

For FAQs and more information please visit:

[www.waykar.com](http://www.waykar.com)



@Waykar



@Waykar



@Waykar



@Waykar



(Scan the QR Code for Live Chat)

We are expecting to see our products fulfill your life and hear your voice.

Your satisfaction means a lot to us.

Please tag us if you share a snap on your social media.

[www.waykar.com](http://www.waykar.com)