

waykar

Portable Air Conditioner

Please read the manual carefully
before using the unit

KY-10K/04A

USER MANUAL

FOR CUSTOMERS

Thank you for purchasing our dehumidifier.

Waykar wishes that our products and services can bring convenience to your work and life. We highly recommend that you keep the manual for reference if you encounter unexpected events using the unit.

Please read the manual carefully to ensure proper use of the dehumidifier. Our dehumidifiers are widely used in family bedrooms, bathrooms, basements, offices and storage rooms, etc.

The dehumidifiers from **Waykar** provide quick and efficient operation to reduce room's humidity and bring you a healthy and comfortable life.

TO ACCESS CUSTOMER SUPPORT FASTER

If there is any problem of the product, please contact Waykar Customer Service at support@waykar.com with your Purchase Order ID to help you address the problem more effectively.

BEFORE FIRST USE:

To prevent any internal damage, it is very important to keep refrigeration units (like this one) upright throughout their journey.

Please leave it standing upright and outside the box for **24 HOURS** before plugging it in.

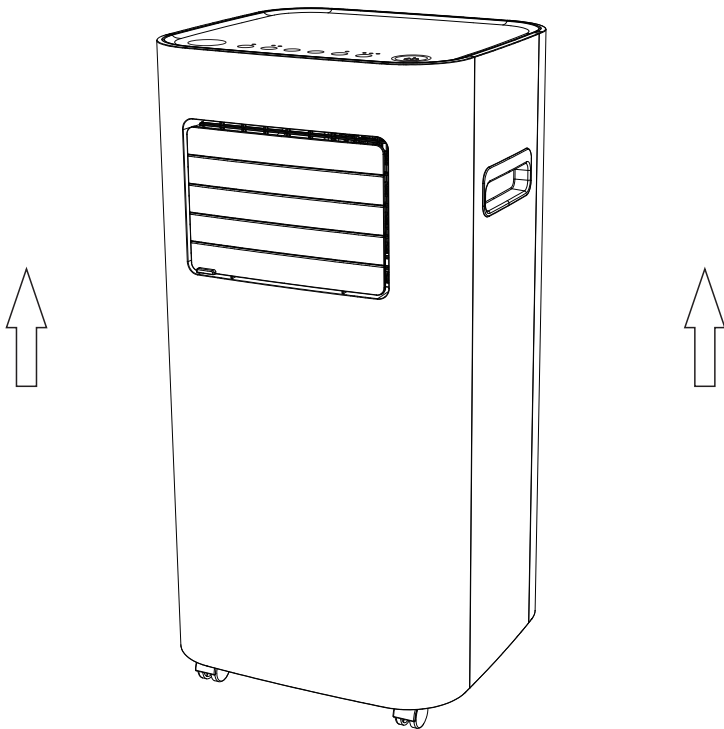

TABLE OF CONTENTS

Safety Instructions.....	01
Parts Description	02
Control Interface.....	03
Operation Instructions.....	04
Cleaning and Maintenance.....	12
Common Faults and Solutions.....	13
Special Notes.....	16
Technical Parametes.....	17
Warranty and Contact Us.....	18

Statement

The graphics and functions provided in this manual may not be the same as the actual product. Please always refer to the actual product.

The model of the machine on the manual is for reference only. Please check the corresponding content and operate the machine based on the actual product.

The right to interpret the relevant terms belongs to the company.

SAFETY INSTRUCTIONS

Safety Notes:

For your safety, please read the manual carefully and keep the manual for future reference. Please use this product according to the instructions of installation and operation of this manual.

- Before cleaning or storing the air conditioner, turn off the power and unplug it from the power outlet.
- Please do not place the machine near heat or flammable dangerous goods.
- Do not insert your fingers or sticks into the air inlet or outlet.
- In order to prevent water leakage, always keep the machine on even surfaces, avoid uneven or sloping ground.
- Do not spray water, insecticides or flammable liquids on the unit.
- When moving this machine, make sure to turn off the power and move slowly.
- When the power cord is damaged, it must be replaced by the qualified technician approved by our company.
- The machine power wiring must be in accordance with national wiring rules, and power line should be connected to the reliable external Earth Line.
- Model specification of safety tube:2A.
- This appliance can not be used by children aged under 8 years old and persons with reduced physical, sensory or mental capabilities or lack of experience and knowledge unless they have been given supervision or instructions concerning use of the appliance in a safe way and understand the hazards involved. Children shall not play with the appliance. Cleaning and user maintenance shall not be made by children without supervision.
- This air conditioner is designed to operate in a working environment between 41°F (5°C) and 95°F (35°C).
- When using air conditioner, other objects surrounding the machine need to be kept at least a distance of 11.8 inches (30cm) as shown in the picture on the right:

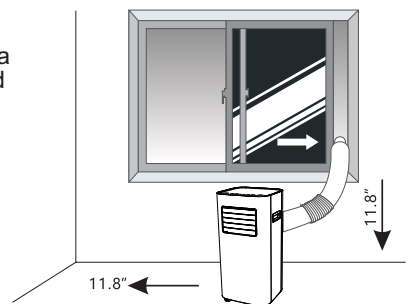

PARTS DESCRIPTION

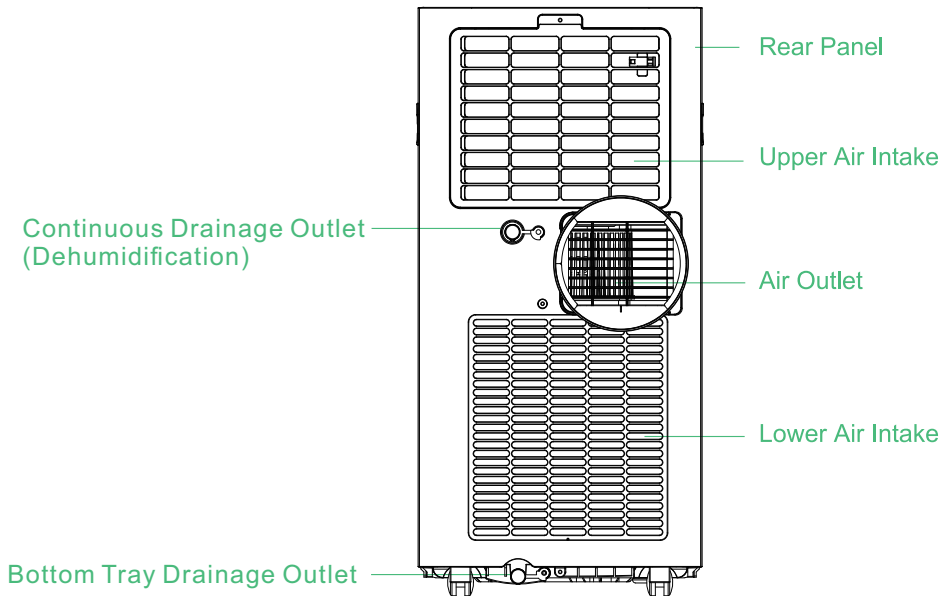
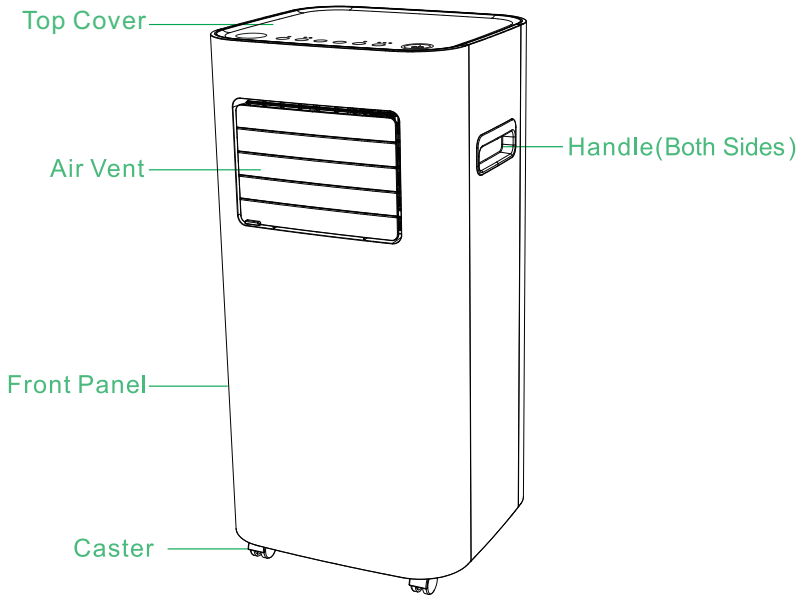

1. Control Panel

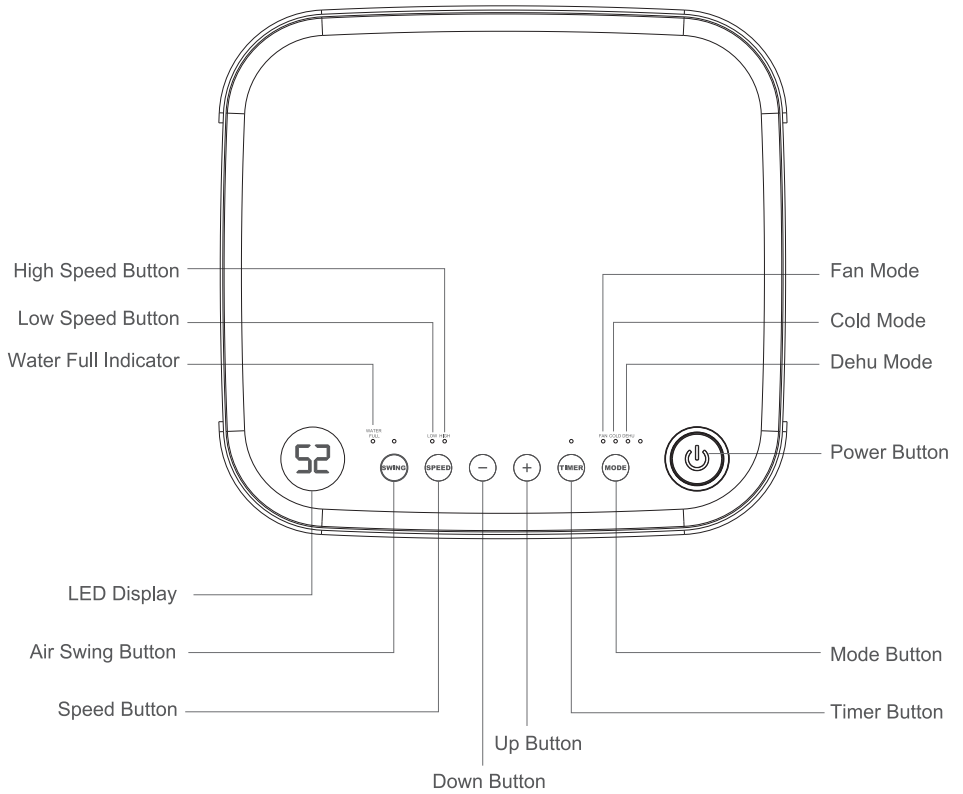

2. Display Status Description

2.1 Power Button

Press to turn on or turn off the machine.

2.2 Mode Indicator

Press to select the desired operating mode. Each time you press this button, you will select the working modes from "FAN", "COOL" to "DEHU" in order. The mode light will indicate you which function has been chosen.

2.3 Wind Speed Indicator

The "SPEED" button is for you to switch to high or low wind speed, the "HIGH" or "LOW" light indicator will be on when you select either of them at "FAN" or "COOL" mode.

2.4 Swing Mode Indicator

Press the "SWING" button to enable or disable the swing mode, when you choose the swing mode, the fan will swing from left to right when blowing the wind.

2.5 Screen Display

The screen will show the cooling temperature when you choose the FAN or COOL mode, and display the " " character when you choose DEHU mode.

Up (+) and Down (-) Buttons:

The temperature can be adjusted when you choose the COOL mode, you can press the (+) or (-) button to adjust the room cooling temperature.

When you choose the FAN mode, the temperature can not be adjusted.

When you choose DEHU mode, the machine will automatically work to dehumidify, according to the environment condition.

OPERATION INSTRUCTIONS

2.6 Timer Indicator

This TIMER setting function is designed for you to set a time to turn off (when the machine is on) or turn on (when the machine is off) the machine, automatically by the timer.

Press the "TIMING" button, you can set the timer within the range of 1-24 hours.

Press the " - " or " + " button, you can set the timer in 1 hour increment or decrement. Long press either of these two buttons can make continuous time setting.

If you set the timer successfully, the "TIMING" indicator light will be on, the screen will display the current humidity after seconds, but when you press the "TIMER" again, you can see the remaining setting time.

If the time is set to 00, this is called the invalid time.

2.7 Water Tray Full Alarm Indicator

Water needs to be drained out when you choose the dehumidification mode. Please connect the drainage hose to "Continuous Drainage Outlet" for continuous drainage.

If the continuous drainage is not being used at "DEHU" mode, the water will be collected by the water tray at the bottom, when the water tray is full, the machine will automatically stop working and the "FULL" indicator will flash and the screen will display "E7" code to remind you that the water tray needs to be emptied.

At this time, you can connect the drainage hose to the bottom tray drainage outlet to drain out the water.

The bottom tray drainage outlet can also be used when draining remaining sewage as well.

Reinstall the rubber plug after draining and restart the machine, the "E7" symbol will disappear.

If the error repeats, call for service.

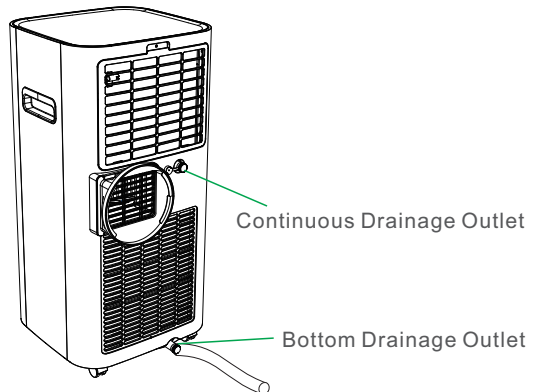



3. Mode Description

3.1 Cool Mode

Ideal for hot muggy weather when you need to cool and dehumidify the room.

To set operation of the appliance correctly, press adjust buttons until the desired temperature is displayed.

Operation:

- Press the "  " until the "COOL" indicator light comes on.
- Press the "+" or "-" to select your desired temperature.
The temperature can be set within a range of 62°F to 86°F.
- Press the "  " button to choose the fan speed (HIGH/LOW).

3.2 DEHU Mode



Ideal for reducing humidity in spring and autumn, during rainy days or in damp rooms, etc.

In dehumidifying mode, the appliance must allow the air exhaust to discharge air externally.

Operation:

- Press the "  " until the "DEHU" indicator light comes on.
- While in this mode, you cannot select a wind speed or adjust the temperature, the fan will work at low speed mode when dehumidification.
- Keep windows and doors closed for the best dehumidifying effect. Do not connect the hose to a window.









3.3 Fan Mode

- Press the "  " until the "FAN" indicator light comes on.
- Press the "  " to choose the fan work at low or high speed, temperature cannot be adjusted at this mode. Do not connect the hose to a window.

OPERATION INSTRUCTIONS

Window Slider, Exhaust Hose and Adaptor Assembly Instructions:

Installation Accessories List

Item	Name	Quantity
	Window Slider Adaptor	1PCS
	Unit Adaptor	1PCS
	Window Slider A	1PCS
	Window Slider B	1PCS
	Window Slider C	1PCS
	Wing Nut	2PCS
	Gasket	2PCS
	Wing Screw	2PCS
	Exhaust Hose	1PCS

Assembly of Window Slider & Exhaust Hose

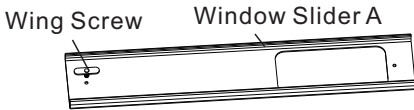

Figure 1

1. Insert the wing screw into the window slider A as the figure 1 shows.

2. Insert window slider B from the side into window slider A (the head of wing screw needs to be inserted into the slot of window slider B), and adjust the assembly length according to requirements.

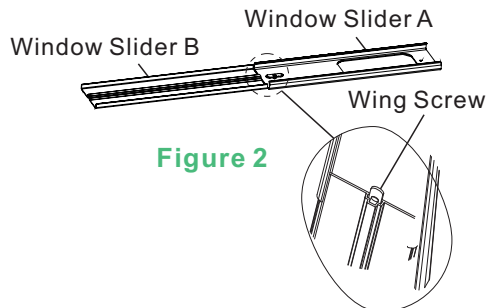
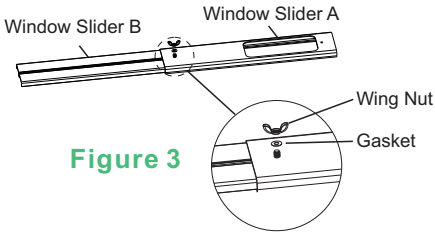

Figure 2

OPERATION INSTRUCTIONS

Assembly of Window Slider & Exhaust Hose

3. Turn over the window slider, put in gasket and wing nut in turn and tighten them.



5. Insert window slider C from the side into window slider B (the head of wing screw needs to be inserted into the slot of window slider B), and adjust the assembly length according to requirements.

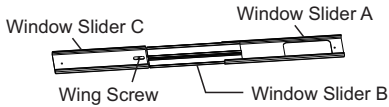

7. Stretch both ends and unfold the exhaust hose.

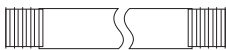

4. Insert the wing screw into the window slider C.

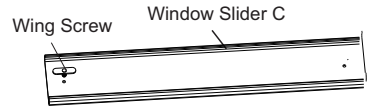

6. Turn over the window slider, put in a gasket and wing nut in turn and tighten them.

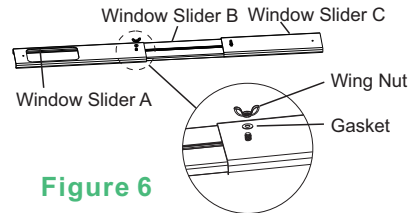

8. Rotate the unit adaptor to the left to screw one end of the exhaust hose, and then rotate the window slider adaptor to the right to screw the other end of the exhaust hose.

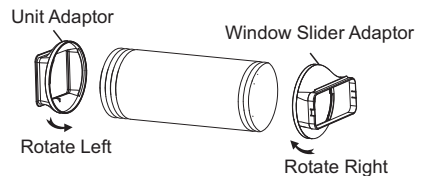

OPERATION INSTRUCTIONS

Assembly of Window Slider & Exhaust Hose

9. Finish the assembly of unit adaptor and window slider adaptor to both ends of the exhaust hose as shown in Figure 9.

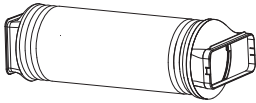

Figure 9

10. Align the window slider adaptor of exhaust hose with the window slider and clamp it tightly.

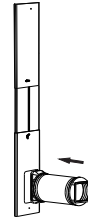

Figure 10

The overall installation of the appliance (left and right sliding window)

11. Open the window where components such as exhaust hose and window sliders need to be installed.

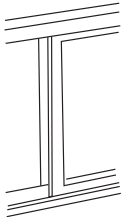

Figure 11

12. Install the exhaust hose and window sliders on the window and close the window in the arrow direction to locate the window sliders tightly.

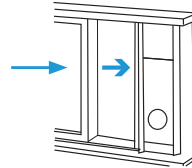

Figure 12

13. Install the unit adaptor of the exhaust hose on the exhaust outlet on the back of the air conditioner and fasten it.

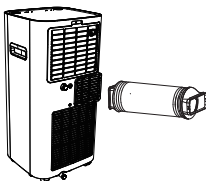

Figure 13

14. The appliance assembly is completed as shown in Figure 14.

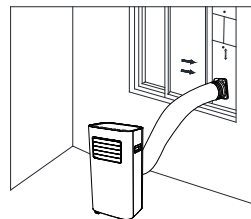

Figure 14

OPERATION INSTRUCTIONS

The Overall Installation of the Appliance (Up and down sliding window)

15. Open the window where components such as exhaust hose and window sliders need to be installed.

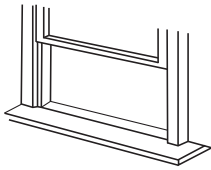

Figure 15

16. Install the exhaust hose and window sliders on the window and close the window in the arrow direction to locate the window sliders tightly.

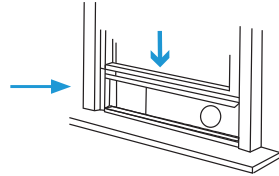

Figure 16

17. Install the unit adaptor of the exhaust hose on the exhaust outlet on the back of the air conditioner and fasten it.

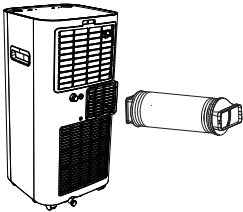

Figure 17

18. The appliance assembly is completed as shown in Figure 18.

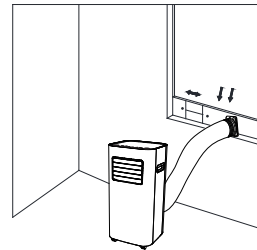
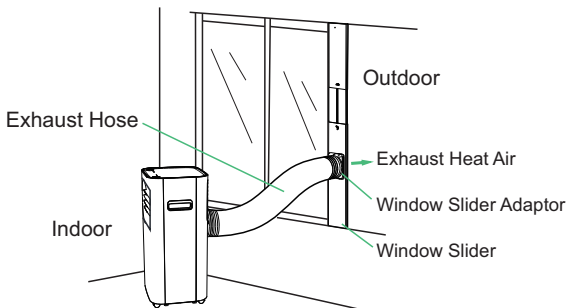

Figure 18

Working Schematic Diagram of the Appliance



OPERATION INSTRUCTIONS

Installation Instructions

- Make sure that you install your unit on an even surface to minimize noise and vibration.
- The unit must be installed near a grounded plug, and the Bottom Drainage Outlet of Collection Tray (found on the back of the unit) must be accessible.
- The unit should be located at least 12 inches (30 cm) from the nearest wall to ensure proper air conditioning. The air vent blade should be at least 19.7 inches (50 cm) away from obstacles.
- Do NOT cover the Intakes or Outlets of the unit, as this could cause damage to the unit.

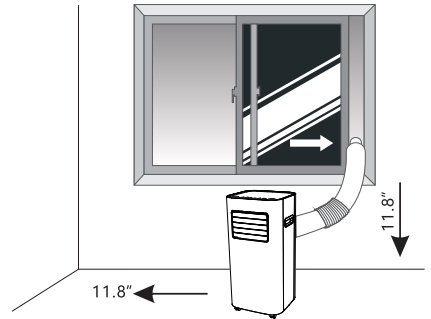

PROMPTS:

The installation of the exhaust hose depends on the operating mode of the air conditioner. When the air conditioner is in COOL mode, the exhaust hose is required; when the it is in FAN or DEHU mode, it is not necessary to install the exhaust hose.

Install Water Drainage Hose

During dehumidification mode, the upper drainage outlet on the back of the unit must be connected to the drainage hose.

1. Unplug the rubber plug of the continuous drainage outlet on the upper side.
2. Insert one end of the drainage hose into the continuous drainage outlet.
3. Link the other end of the drainage hose to the sewer or other container (basin or bucket).

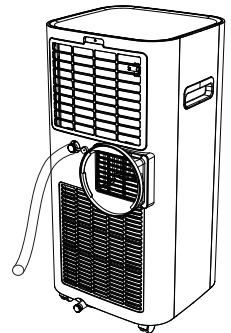

CLEANING AND MAINTENANCE

⚠ WARNING:

Turn the air conditioner off and remove the plug from the wall outlet before cleaning.

A- Cleaning the unit

Please use a soft and slightly wet textile or cloth to clean it.

B- Cleaning filter

- Take out the unit adaptor and air filter 1 (remove the screw above first) in turn.
- Clean the filter: Use a vacuum cleaner to gently remove the dust from the surface of the filter1 and filter 2.

If very dirty, you can wipe filter 1 with warm water and a mild detergent and dry it completely.

- Slowly insert the filter back into the unit, and install the unit adaptor.

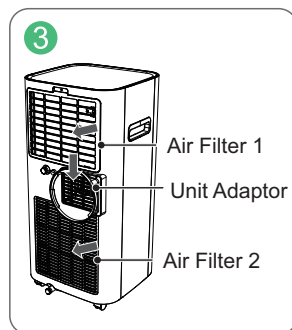
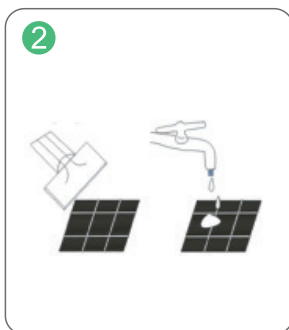
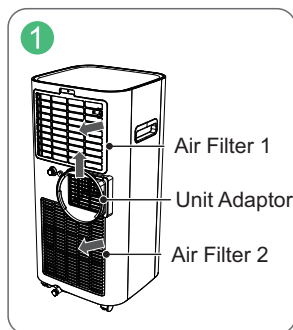

C-air conditioner storage

When you want to store the appliance, you don't use it for a long time. Please pay attention to the following steps:

1. Empty the water in the water tray.
2. Roll up the power cord and tie it up.
3. Clean the filter.
4. Place the machine in a cool and dry environment.

COMMON FAULTS AND SOLUTIONS

Check the information below for troubleshooting steps. It will save you time to resolve issues that may happen with the unit.

The list includes most of the common cases, but not the results of defective units, crafts or materials in the unit.

If all troubleshooting steps have been exhausted and the issue is still occurring, please feel free to reach out to Waykar Customer Service to get further assistance.

Problem	Reason	Method
Unit does not work	Is the power cord connected properly?	Make sure that the unit's plug is inserted properly into the power outlet.
	The unit will take approximately 3 minutes of operation before cooling occurs.	After the unit has stopped, it cannot be restarted until 3 minutes have elapsed.
Frequent shutdowns	Room temperature is lower than the set temperature.	Decrease the set temperature.
	Is there blocking around the air inlet?	Clean up the dirty form the air outlet and intake.
Unit does not cool well	The windows and doors in the room are open.	Make sure all windows and doors are closed.
	The air filter is blocked with dust or animal hair.	Turn off the unit and clean the filter according to instructions.
	Is there blocking around the air inlet?	Clean up the dirty form the air outlet and intake.
	Temperature setting is too high or too low.	Decrease or increase the set temperature.
	There are heat sources inside the room.	Remove the heat sources if possible.
	Exhaust air hose is not connected or blocked.	Connect the hose and make sure it can function properly.

COMMON FAULTS AND SOLUTIONS

Gurgling sound	The sound comes from the flowing of the refrigerant inside the airconditioner.	It is normal.
Unit does not turn on when pressing ON/OFF button	E7 Error Code.	The water collection tray is full. Turn off the unit, drain the water from the water collection tray and restart the unit.
The appliance makes a loud noise when operating	Is the machine tilted?	Move the machine to a horizontal position.
	Is there blocking around the air inlet?	Clean up the dirty form the air outlet and intake.
	Is the filter installed correctly?	Please check whether the filter packing bag removed and the filter installed correctly.
Leaking when moving	Excessive condensation water.	Before moving, please drain the water in the sink.
	Check whether the rubber drainage plug on the continuous drainage port on the top of the unit is broken?	Replace with a new rubber drainage plug.
There are water droplets on the surface.	It is normal for water droplets to form on the air outlet, panel when running in an environment with relatively high environmental humidity.	It is normal.
	Long-term refrigeration operation in an open space will produce water droplets.	Please close doors and windows to ensure operation in a closed space.
	Too low wind speed may also cause water droplets.	Increase wind speed appropriately.
	A too small opening angle of the louvers blade may also cause this phenomenon.	Increase the angle of the louvers blade or set it to automatic swing.

Warning:

If the appliance is still not working properly as expected and the troubleshooting steps or solutions above may not resolve the issue. Please unplug the power and shut down the unit then contact Wavkar customer service support@waykar.com.

4. Error&Protection Code

Number	Error Code	Name of the fault	Note
1	E1	Humidity sensor error	
2	E2	Defrost temperature sensor error	
3	E4	Temperature sensor error	
4	E7	Water tray is full, empty the tray	

Attention

When the machine signals the alarm, it will flash or display the alarm, in case there are multiple errors on the unit, it will display the error in turn.

When one of the above malfunctions occurs, the buzzer will alarm for a few seconds. Press any key during the alarm to release the alarm sound.

If the malfunction is still present, please don't hesitate to contact Waykar Customer Service email: support@waykar.com for help.

Note:

Before starting the machine, please ensure that the air outlet has been opened, otherwise the machine will overheat. Do not pull out the power cord directly to stop the machine.

SPECIAL NOTES



- 1 When using, please do not put the machine at the soft and uneven ground, avoid vibration and movement.



- 2 Do not insert thin rods and hard objects into the unit to avoid malfunction and danger.

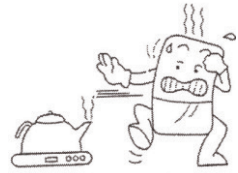

- 3 When using, please keep the machine away from heating furnace, electric kettle and other heat sources.



- 4 When using, please close doors and windows to achieve the best cooling/remove humidity effect.

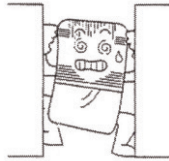

- 5 Please do not put objects around the body. If the ventilation is blocked, the cooling effect will be affected.



- 6 If do not use the product for a long time, please unplug the power cord.



- 7 When cleaning the air conditioner, please use the wet textile wipe gently, do not shoot the water directly.



- 8 Please do not put any object on the appliance.



- 9 Please clean the filter every two weeks (do not use hot water above 104°C, gasoline, toluene)



- 10 When continuous drainage, the drainage hose must be placed horizontally, cannot be an uneven and winding situation.



- 11 After clean the filter, please do not let it dry direct sunlight. Avoid the filter deformation.



- 12 Before moving and carrying the machine, please first pour out the water in the water tray.

TECNICAL PARAMETERS

Model	KY-10K/04A
Power Source	110-120V-60Hz
Cooling Rated Current (104°F/80°F)	12A
Cooling Current (95°F/83°F)	10.0A
Cooling Capacity (95°F/83°F)	10000Btu/h
Motor FLA	1.1A
Motor Compressor	RLA:7.65A LRA:35A
Refrigerant	R410A/9.17ozs (260g)
Max Allowable Pressure	800PSIG (5.5MPa)
High Pressure	580PSIG (4.0MPa)
Low Pressure	247PSIG (1.7MPa)
Noise	52dB (A)
Dimensions	12.9*12*26.6 inches
Weight	44LB



WARNING:

This product can expose you to chemicals including Styrene and its compounds, which is known to the State of California to cause cancer and birth defects or other reproductive harm. For more information go to: www.P65Warnings.ca.gov

Warranty

Waykar offers a 12-month warranty to all of our products together with the original proof of purchase when a defect occurred, including those newly purchased and unused, from Waykar or through an authorized reseller, wholly or substantially, or as a result of faulty manufacturing parts, or workmanship during the Warranty Period. The warranty does not apply if damage is caused by other factors, including but without limitation of:

- (a) Normal wear and tear;
- (b) Abuse, mishandling, accident or failure to follow operating instructions;
- (c) Exposure to liquid or infiltration of foreign particles;
- (d) Servicing or modification of the product other than by Waykar.

There are our general terms for the warranty service, but we always encourage our customers to contact us if any issues, regardless of warranty terms. If you are experiencing an issue with Waykar product, you can reach out to us at support@waykar.com, we will dedicate our efforts to resolve it for you.

Extend Your Warranty by 1 Year

Register your product at www.waykar.com to extend your 1-year warranty by an additional year.

*Please fill out all required fields and include your Order ID, Date of Purchased if applicable.

Customer Support

If you have any questions or concerns about your product, please feel free to contact our expert support team. Waykar customer service is here to help.

Waykar Office

13211, Spring Street Baldwin Park, CA, US

Email: support@waykar.com

Live Chat: www.waykar.com

Support Hours

24 Hours available

*Please have your Order Number ready before contacting customer support.

waykar

For FAQs and more information please visit:

www.waykar.com



@Waykar



@Waykar



@Waykar



@Waykar



(Scan the QR Code for Live Chat)

We are expecting to see our products fulfill your life and hear your voice.

Your satisfaction means a lot to us.

Please tag us if you share a snap on your social media.

www.waykar.com