

waykar

Home Dehumidifier

Please read this manual carefully
before using the product

JD026E-130

USER MANUAL

FOR CUSTOMERS

Thank you for purchasing our dehumidifier.

Waykar has been committed to developing powerful and easy-to-use products to bring more convenience to your life. We highly recommend you to keep this user manual for future reference in case of unexpected problems.

Please read this user manual carefully to ensure proper use of the dehumidifier. This dehumidifier is perfect for reducing humidity in family bedrooms, bathrooms, basements, offices, storage rooms and more.

Waykar dehumidifier reduce the room humidity efficiently, creating a more healthy and comfortable environment for you and your family.

REQUESTING CUSTOMER SERVICE

If there are any problems of the product, please contact Waykar Customer Service at support@waykar.com with your Purchase Order ID. We'll help you solve the problems as soon as possible.

BEFORE FIRST USE:

To protect the product from any internal damages, please keep the product in the upright position throughout its journey.

Please take out the product and leave it standing in the upright position for **24 HOURS** before plugging it in.

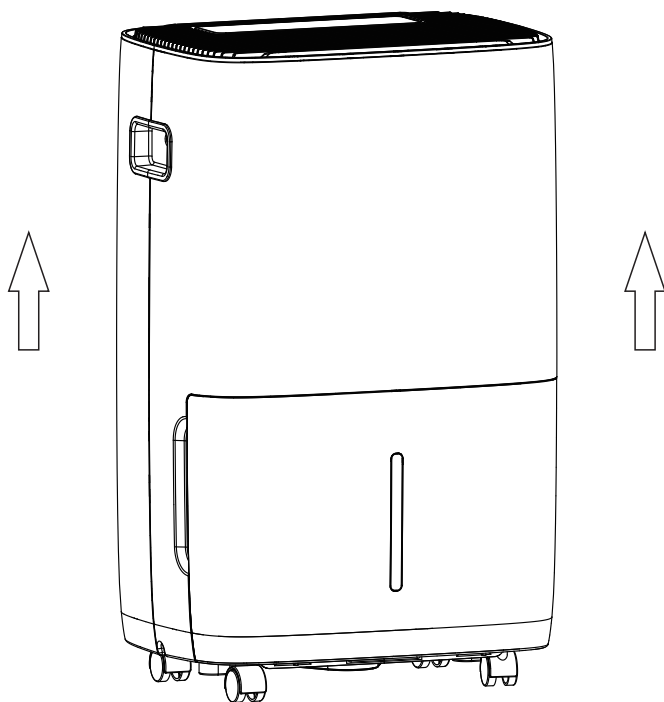

TABLE OF CONTENTS

FEATURES	01
SAFETY PRECAUTIONS.....	02
SPECIFICATIONS	04
PRODUCT DRAWINGS.....	05
OPERATION INSTRUCTIONS	06
DRAINAGE	08
MAINTENANCE & CLEANING	10
TROUBLESHOOTING.....	11
SPECIAL NOTES.....	12
WARRANTY & CONTACT US	13

FEATURES

FEATURES

Powerful Moisture Removal

With the cutting-edge technology, the dehumidifier powerfully removes moisture from the air to reduce the room humidity level and keep the indoor air dry and comfortable.

Lightweight Portable Design

The dehumidifier is compact and lightweight. The casters at the bottom make it easy to move the machine from one room to another.

Low Temperature Operation with Automatic Defrost Function

After the compressor runs continuously for 10 minutes, start to detect the temperature of the coil. When the temperature of the coil is $\leq -2^{\circ}\text{C}$ (28.4°F) for more than 10 seconds, the compressor will stop immediately, and the fan will be forced to run with high wind. After 3 minutes, when it is detected that the coil temperature is $\geq 5^{\circ}\text{C}$ (41°F) for more than 10 seconds, then exit the anti-frost, and the compressor and fan will return to normal; (if the anti-frost time is longer than 10 minutes, it will automatically exit)

During the anti-frost period, if the water is full, the fan will be turned off. After the water level is restored, the fan will resume forced high-wind operation; (if the anti-frost time is longer than 10 minutes, it will automatically exit)

Adjustable Humidistat

Allows you to set different humidity levels for different rooms.

Timer On / Off

Program the machine to turn on and off automatically.

Quiet Operation

The dehumidifier operates with a low noise level.

Energy Efficient

The power consumption of the machine is low.

SAFETY PRECAUTIONS

IMPORTANT NOTICE FOR FIRST USE :

For your safety, please read the manual carefully and keep it for future reference.

Please install and use this product according to the instructions in the manual.

- Please unplug the power cord before cleaning or storing the machine.
- The machine can be used indoor except for laundry rooms.
- Do not place the machine close to heat-generating devices or flammable and dangerous materials.
- Never put your fingers or other objects into the intake or discharge ducts.
- Do not sit or stand on the machine.
- Pour out the collected water in the tank as required.
- Do not operate the dehumidifier in a closed area such as a closet, as it may cause a fire.
- Do not place the machine near edible items, artwork, or scientific materials.
- Install the drain hose at a downhill grade to make sure that condensed water can be drained continuously.
- If the power cord is damaged, please contact the manufacturer or qualified person to replace it to avoid hazards.
- The machine must be positioned so that the plug is accessible.
- Please keep a distance of 20 cm away from the wall or other objects to ensure great air circulation.
- The machine shall be installed in accordance with local national wire regulations.
- The machine can not be used in public transportation.
- This machine can be used by children aging from 8 years and above and persons with reduced physical, sensory or mental capabilities or lack experience and knowledge if they have been given supervision or instructions of the machine in a safe way and understand the hazards involved. Children shall not play with the machine. Cleaning and user maintenance shall not be made by children without supervision.
- Children should be supervised to ensure that they do not play with the machine.
- Please do not operate the machine if it is obviously damaged.

SAFETY PRECAUTIONS

WARNINGS

- Do not accelerate the defrosting process or clean the ice by yourself, other than those recommended by the manufacturer.
- Do not pierce or burn the machine .
- Be aware that refrigerants may not have an odour.
- The machine shall be installed, operated and stored in a room with a floor area larger than 4m².
- The machine shall comply with national gas regulations.
- Servicing shall be performed only as recommended by the manufacturer.
- When not in use for a long time, the machine shall be stored to prevent mechanical damage.
- If you need to repair the machine, please contact the nearest authorized Service Centre and strictly follow manufacturer's instruction only.

Storing the Dehumidifier

When the unit is not used for a long period of time or you want to store it, please notice the following steps:

1. Empty any water left in the tank.
2. Put the power supply cord away and wrap it around the hook on the back of the unit.
3. Clean the air filter.
4. Place it in a cool and dry place.

Clearance

Keep the minimum clearance at 18 inches around the dehumidifier when it is operating as shown in the right drawing.

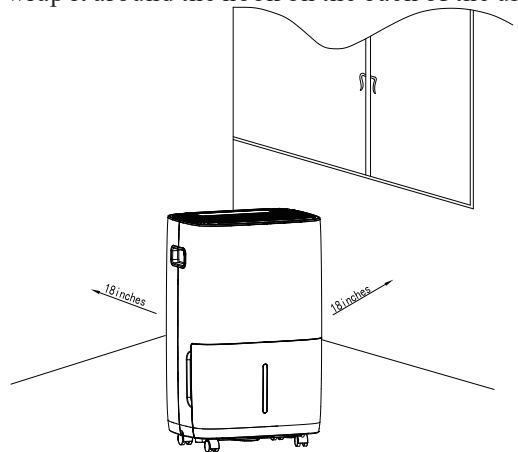

SPECIFICATIONS

MODEL	JD026E-130
POWER SOURCE	115V~ 60Hz
TOTAL INPUT CURRENT	6.5A
MOISTURE REMOVAL (65°F, 60%RH)	40.52 PINTS (19.17 L/DAY)
MOISTURE REMOVAL (80°F, 60%RH)	60 PINTS (28.38 L/DAY)
MOISTURE REMOVAL (86°F, 80%RH)	100 PINTS (47.3 L/DAY)
MOISTURE REMOVAL (95°F, 90%RH)	130 PINTS (61.49 L/DAY)
INPUT POWER (65°F, 60%RH)	425 W
INPUT CURRENT (65°F, 60%RH)	3.8A
IEF (65°F, 60%RH)	1.85 L/kWh
MOTOR FLA	0.58 A
MOTOR COMPRESSOR(RLA/LRA)	3.12A / 20A
REFRIGERANT	R410A/190g (6.71oz)
MAXIMUM ALLOWABLE PRESSURE	3.72MPa (540psig)
HIGH PRESSURE	2.2MPa (320psig)
LOW PRESSURE	0.85MPa (123psig)

- The dehumidification capacity is rated at a room temperature of 18.3 °C (64.94°F) with a relative humidity of 60%RH.
- If specifications are changed in the future, the product nameplate will reflect the new specifications.
- The working temperature range of this machine is between 7 °C (44.6°F) and 32 °C (89.6°F).
- If the room temperature is not within this range, the unit will not operate normally.
GWP value of R410A

WARNING

This product can expose you to chemicals including Styrene and its compounds, which are known to the State of California to cause cancer and birth defects or other reproductive harm. For more information, please visit: www.P65Warning.ca.gov.

PRODUCT DRAWINGS

Front

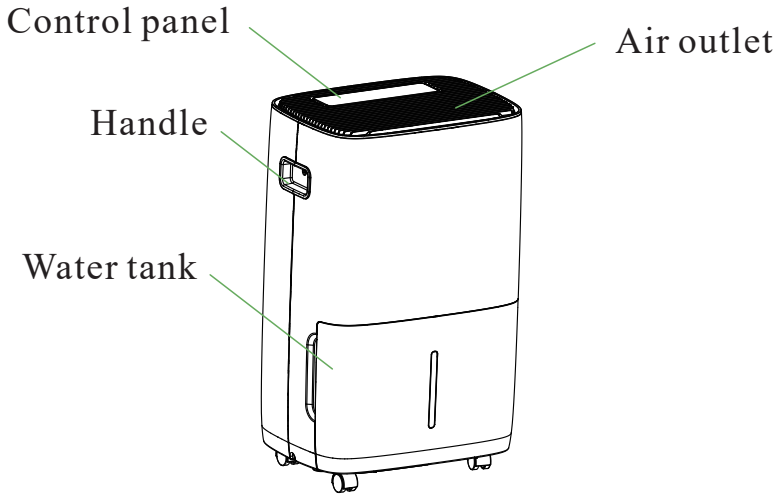

Back

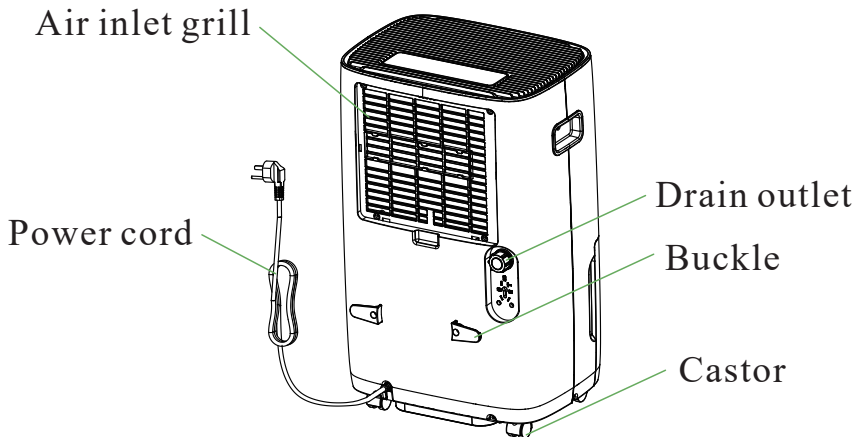

OPERATION INSTRUCTIONS

Control Panel

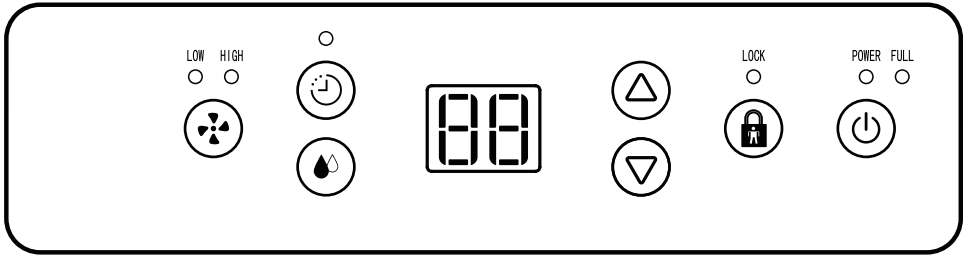

Humidity Level & Timer Display

The indicator has 3 functions:

1. When the machine is powered on, it will indicate the current room humidity.
2. When you set the humidity, it will indicate the humidity that you have set.
3. When you program the timer, it will show the timing duration.
4. When the environment humidity is lower than 35%RH, it will show “35”.
5. When the environment humidity is higher than 95%RH, it will show “95”.

Operating Instructions

When the machine is powered on for the first time, it will buzz the power sound before entering into the standby status.

“” Turn On/Off:



When the machine is powered on, press “” key to start normal operation of the machine, and then press “” key to stop operation of the machine.

“” Fan Speed:



You can press “” this button to adjust the fan speed between low and high speed. The corresponding indicator light will turn on when the fan speed is set.

OPERATION INSTRUCTIONS

“” Humidity Setting:



Press the “” button to enter set the humidity level, you can press “” or “” to adjust the humidity from 40%RH to 80%RH in 5% increment. The LED display will flash when you adjust the humidity. The default humidity level is 40%RH.



Press and hold the humidity setting for 3 seconds to switch the front display on and off.

Press “” and “” to preset your desired humidity level. The humidity is adjustable between 40%RH-80%RH in 5%RH increment. The default humidity is 40%RH.

“” Timer Setting:



Press “” button to set a timer:

(1) In the standby state, press the timing button to set a timer to automatically start the machine. The timing light will turn on, and the display will initially show the timing at 01. Press “” and “” to adjust the timer. In the timing process, you can press the timing button again to cancel it.

(2) In the power-on state, press the timing button to set a timer to automatically shut down the machine. The clear display will show the timing at 01. Now, press the “” or “” button to adjust the timer.

(3) The timing range is 01-24h.

“” Lock Setting:

In power-on state, press and hold the Lock button “” to lock the machine. The indicator will light up. Then you can press and hold the Lock button “” again to unlock the button.

DRAINAGE

MANUAL DRAINAGE

Emptying the Water Tank

When the water tank is full, the tank full indicator light “^{FULL} ○ ” will turn on, and the dehumidifier will stop automatically. The buzzer will beep 15 times to remind you to empty the water tank.

1. Gently press the sides of the tank with both your hands and pull the tank out.
2. Pour out the collected water.
3. Install the water tank steadily into the machine.

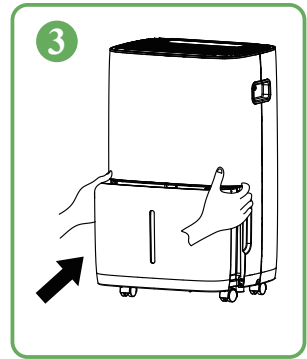
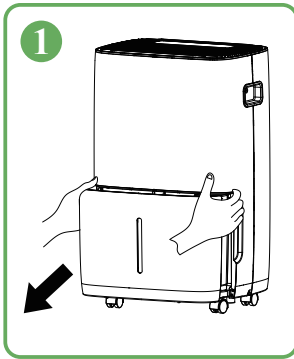

NOTE

1. Do not remove the float from the water tank. The full tank sensor will no longer be able to detect the water level correctly without the float and water may leak from the tank.

2. If the tank is dirty, please wash it with cold or lukewarm water. Do not use detergent, scouring pads, chemically treated dust cloths, gasoline, benzene, thinner, or other solvents, as these may scratch and damage the tank and cause water leakage.

3. When replacing the tank, please press the tank firmly into place with your both hands. If the tank is not positioned properly, the “TANK FULL” sensor will be activated, and the dehumidifier will not operate.

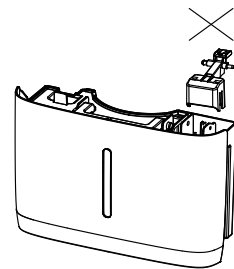

DRAINAGE

CONTINUOUS DRAINAGE

1. Take out the drain hose connector from the water tank.
2. Unscrew the outlet cover on the back of the machine.
3. Install the drain hose connector and connect the drain hose.
4. The dehumidifier will continuous drain water when the drain hose is properly installed.

1

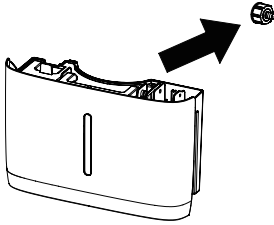

2

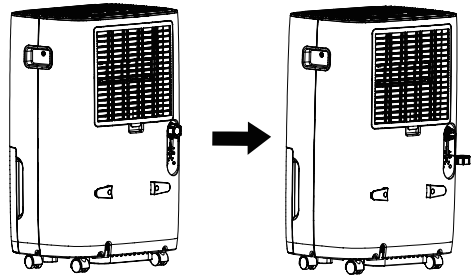

3

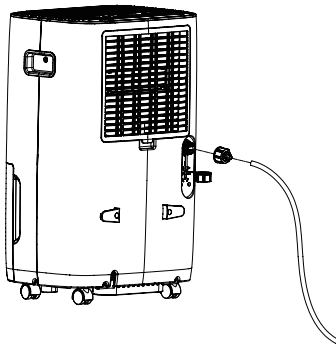

4

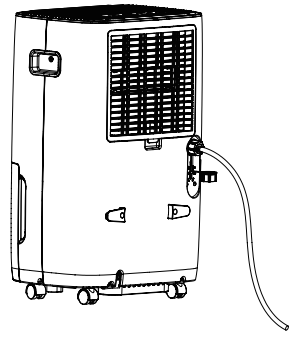

⚠ Warnings:

Please do not block the drain port or drain hose. If the blockage occurs, the condensed water will flow into the water tank.

Please do not bend the drain hose. Make sure that the height of the drain hose is lower than the drain port.

The drain hose must be firmly connected to the drain port.

MAINTENANCE & CLEANING

Cleaning the Dehumidifier

Cleaning the Body

Wipe it with a soft damp cloth.

Cleaning the Air Filter

1. Open the inlet grill and wash it with water.
2. Run a vacuum cleaner lightly over the surface of the air filter to remove dirt. If the air filter is exceptionally dirty, please wash it with warm water and a mild cleanser and dry thoroughly.
3. Insert the filter into the grill smoothly.

1.

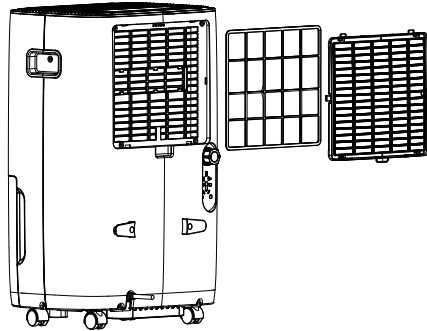
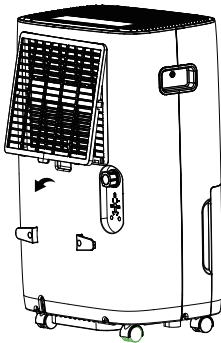

2.

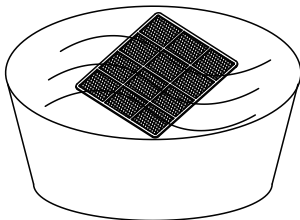

3.

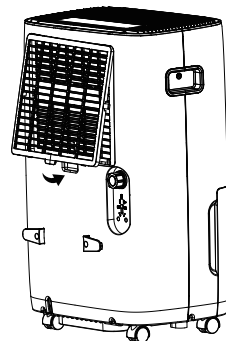

TROUBLESHOOTING

The following list contains some abnormal conditions that are not faults caused by manufacturing process or material defects.

Problems	Possible Causes	Solutions
The machine doesn't operate	Is the power cord connected properly?	Plug the power cord into the outlet.
	Is the tank full indicator flashing? (The tank is full or in a wrong position.)	Empty the water tank and then reposition the tank.
	Is the temperature of the room above 32°C(89.6°F) or below 7°C(44.6°F)?	Make sure the working temperature is between 7°C(44.6°F) and 32°C(89.6°F).
The dehumidifying function doesn't work	Is the air filter clogged?	Clean the air filter as instructed under "Cleaning the dehumidifier".
	Is the intake duct or discharge duct obstructed?	Remove the blockage from the discharge duct or intake duct.
No air is discharged	Is the air filter clogged?	Clean the air filter as instructed under "Cleaning the dehumidifier".
The operation is noisy	Is the unit tilted or unsteady?	Move the unit to a stable, sturdy location.
	Is the air filter clogged?	Clean the air filter as instructed under "Cleaning the dehumidifier".
According to "E1"	Abnormal exhaust pipe temperature sensor	Check exhaust pipe temperature sensor and related circuit.
According to "E2"	Abnormal coil temperature sensor	Check coil temperature sensor and related circuit.
According to "E3"	Communication failure	Check to see if the main PCB is connected properly. If not, replace it with a new main PCB.
According to "EH"	Abnormal humidity sensor	Check if the wires of the temperature and humidity module are loose. If not, replace the temperature and humidity module or the motherboard.

SPECIAL NOTES



- 1 When using the machine, please do not put it on a soft or uneven ground to prevent vibration and movement.



- 2 Do not insert any thin rods or hard items into the machine to prevent malfunctions and dangers.



- 3 When using the machine, please keep it away from any heating furnaces, electric kettles and other heating sources.



- 4 When using the machine, please close doors and windows for the optimal moisture removal effect.



- 5 Please do not put any objects around the machine. The dehumidification effect will be affected if the ventilation is bad.



- 6 Please unplug the machine from the power source if you do not use it for a long time.



- 7 When cleaning the machine, please use wet cloth to wipe gently. Do not spray water on it directly.

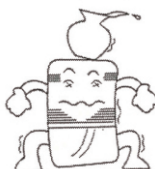

- 8 Please do not put any objects on the dehumidifier.



- 9 Please clean the filter every two weeks. Do not use hot water above 104°F, alcohol, gasoline or toluene.



- 10 When using the hose to drain continuously, please place the hose horizontally and make sure it is even and not winded.



- 11 After cleaning the filter, please do not dry it under direct sunlight to prevent it from deforming.



- 12 Before moving or carrying the machine around, please empty the water tank first.

WARRANTY & CONTACT US

Warranty

Waykar offers a 12-month warranty to all of our products together with the original proof of purchase when a defect occurred, including those newly purchased and unused, from Waykar or through an authorized reseller, wholly or substantially, or as a result of faulty manufacturing parts, or workmanship during the Warranty Period.

The warranty does not apply if damage is caused by other factors, including but without limitation of:

- (a) Normal wear and tear;
- (b) Abuse, mishandling, accident or failure to follow operating instructions;
- (c) Exposure to liquid or infiltration of foreign particles;
- (d) Servicing or modification of the product other than by Waykar.

There are our general terms for the warranty service, but we always encourage our customers to contact us if any issues, regardless of warranty terms.

If you are experiencing an issue with Waykar product, you can reach out to us at support@waykar.com, we will dedicate our efforts to resolve it for you.

Extend Your Warranty by 1 Year

Register your product at www.waykar.com to extend your 1-year warranty by an additional year.

*Please fill out all required fields and include your Order ID, Date of Purchased if applicable.

Customer Support

If you have any questions or concerns about our product, please feel free to contact our expert support team. Waykar customer service is ready to help.

Waykar Office

13211, Spring Street Baldwin Park, CA, US

Email: support@waykar.com

Live Chat: www.waykar.com

Support Hours

24 Hours available

*Please have your Order Number ready before contacting customer support.

waykar

For FAQs and more information please visit:
www.waykar.com



@ Waykar



@ Waykar



@ Waykar



@ Waykar



(Scan the QR Code for Live Chat)

We are expecting to see our products fulfill your life and hear your voice.

Your satisfaction means a lot to us.

Please tag us if you share a snap on your social media.

www.waykar.com