



SPITZER EL100
Remote Controlled Electric Golf Caddy
User Manual



**WARNING: PLEASE FOLLOW ALL ASSEMBLY INSTRUCTIONS AND READ
AND UNDERSTAND THE OPERATING INSTRUCTIONS BEFORE YOU
OPERATE THE CADDY, EITHER MANUALLY OR BY REMOTE CONTROL.**

User Manual version 2.2

PLEASE READ BEFORE RETURNING THIS PRODUCT FOR ANY REASON:

If you have a question or experience a problem with your Spitzer Golf Caddy, call 1-800-814-6536 to speak with a support representative. Or for fast response, email us at support@spitzerproducts.com

****DISCLAIMER SAFETY WARNING****

OPERATORS ARE SOLELY RESPONSIBLE FOR SAFE OPERATION and MAINTENANCE OF THIS DEVICE. AS A REMOTELY CONTROLLED DEVICE, EXTREME CAUTION AND CARE MUST BE TAKEN TO AVOID INJURIES, DAMAGE OR LOSS. UNDER NO CIRCUMSTANCES DOES SPITZER GOLF ASSUME ANY RESPONSIBILITY FOR OPERATOR SAFETY, INJURIES OR PRODUCT LOSS.

Table of Contents

1.0 Introduction	4
1.1 Features	4
1.2 Packing List	4
2.0 Assembly Instructions.....	6
3.0 Manual Handle Control	8
3.1 Variable Speed Control Knob	9
4.0 Remote Control	Error! Bookmark not defined.
4.1 Functions	Error! Bookmark not defined.
4.2 Important Notes – PLEASE READ CAREFULLY	Error! Bookmark not defined.
5.0 Operating Instructions	10
5.1 Battery Charging & Maintenance	10
6.0 Caddy Self-Test (IMPORTANT)!	11
6.1 Non-Moving Test (Initial Test)	11
6.2 Moving Test (Prior to each use)	12
6.3 Recommendations for Efficient and Safe Operation	12
7.0 Additional Functions.....	14
7.1 Free-Wheel Mode.....	14
7.2 Controller/Remote Frequency Adjustment	Error! Bookmark not defined.
7.3 Tracking Adjustment	14
8.0 General Maintenance	16
9.0 Electronic Systems	17
10.0 Technical Specifications EL100	18
11.0 Frequently Asked Questions (FAQ)	20

1.0 Introduction

1.1 Features

The SPITZER Remote Control Golf Trolley/Caddy features manual and remote controls to provide the user with:

- An electrically assisted manually controlled movement of the cart while you walk-along with it. This operation is controlled through the manual control handle on the cart.
- A remote controlled electrically assisted movement of the cart while you remote control the cart by means of a wireless handheld remote control.

1.2 Packing List

The following is a list of parts that the package should normally contain. If your package is missing any parts, please contact support@spitzerproducts.com immediately.

Standard Parts

- 1 x Caddy Frame
- 2 x Rear Wheels
- 1 x Battery Pack (Battery, Bag, Leads)
- 1 x Charger
- 1 x Tool Kit
- 1 x User Manual, Warranty

Optional Accessories – Available at www.spitzerproducts.com

- Cup Holder
- Umbrella Holder
- Seat and Seat Holder
- Carrying Bag
- Rain Cover
- Scorecard Holder

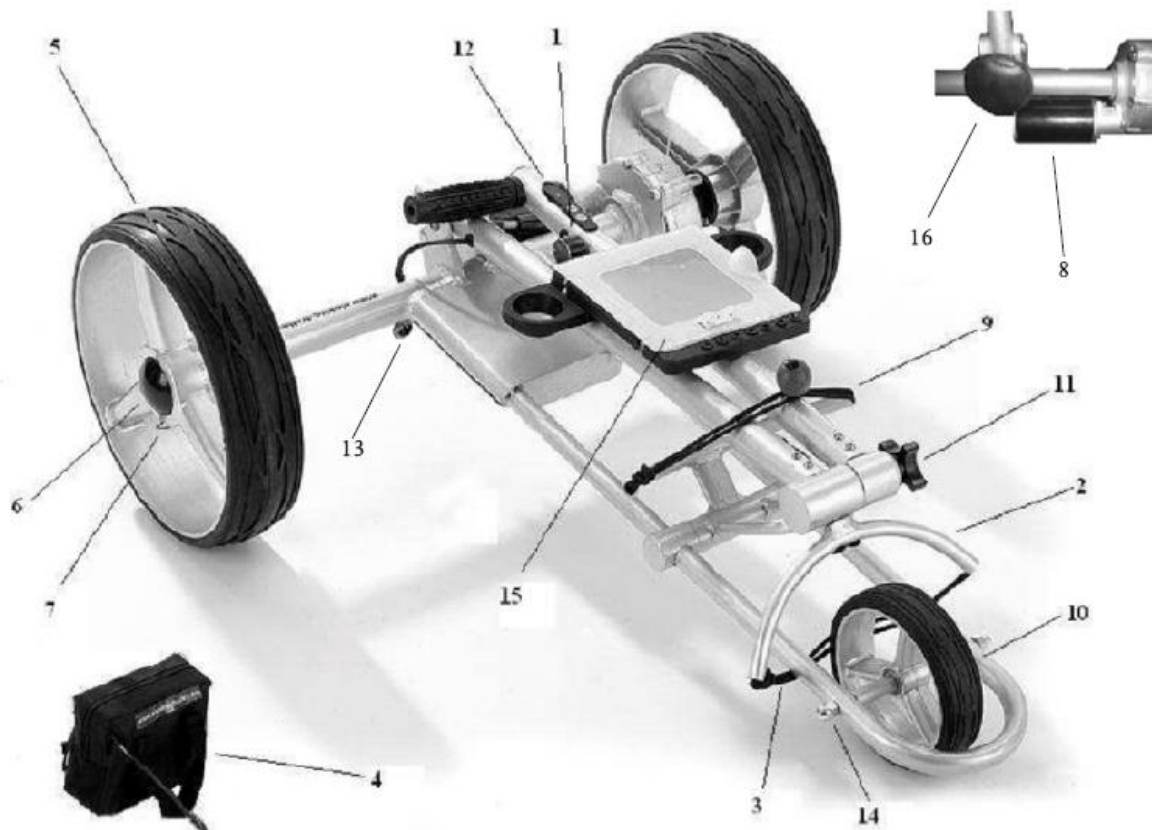

- 1. Manual Rheostat Speed Control
- 2. Upper Bag Support
- 3. Bag Support Strap
- 4. Battery (with Bag) may not be exactly as shown
- 5. Rear Wheel
- 6. Wheel Cap
- 7. Rear Wheel Quick Release Catch
- 8. Dual Motors

- 9. Lower Bag Support
- 10. Front Wheel
- 11. Upper Arm Frame Lock Knob
- 12. Manual Handle Controls
- 13. Battery plug
- 14. Front wheel Adjustment bolt
- 15. Score Card Holder (optional)
- 16. Lower Frame Lock Knob

2.0 Assembly Instructions

1. Unpack all items carefully and check parts inventory.
2. Place frame structure (one piece) on soft and clean ground to protect frame from being scratched. Attach wheels to axles by pushing wheel locking button on the outside of the wheel and inserting the axle extension into the wheel. **Make sure to keep the locking button on the outside of the wheel pushed in during this process. Ensure the wheel's female wheel hub sits inside the male wheel hub on the axle.** If not locked in, the wheel will not be connected to the clutch and will not be propelled!!! Test the lock by trying to pull the wheel out. To disassemble the wheels proceed in reverse order.

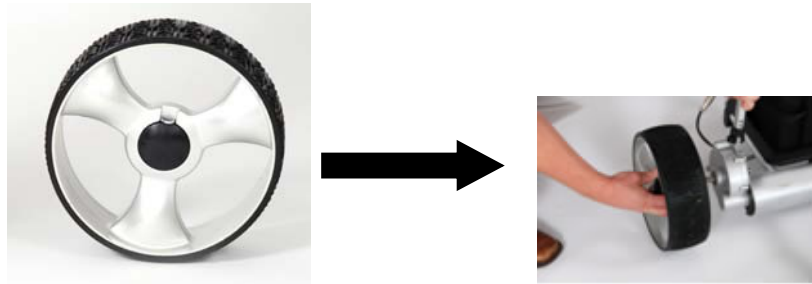

3. Erect Frame by unfolding and locking the lower support structure to the main frame by turning the **lower frame locking knob** until tight and secure. Proceed in reverse for folding the caddy for storage or transport.



4. Unfold and lock the upper arm by turning the **Upper Arm Frame Lock knob**.



5. Place battery pack on battery tray and fasten Velcro strap around battery and frame tightly. Not using the Velcro strap to secure the battery to the frame could damage battery. Insert battery plug into caddy outlet. **Note: BEFORE CONNECTING make sure that Main On/Off switch on handle is in OFF (0) position and the remote control is stored securely!!!**





6. Install Scorecard Holder and other accessories, such as beverage or umbrella holder below handle in the foreseen places or receptors. (Optional Accessories)

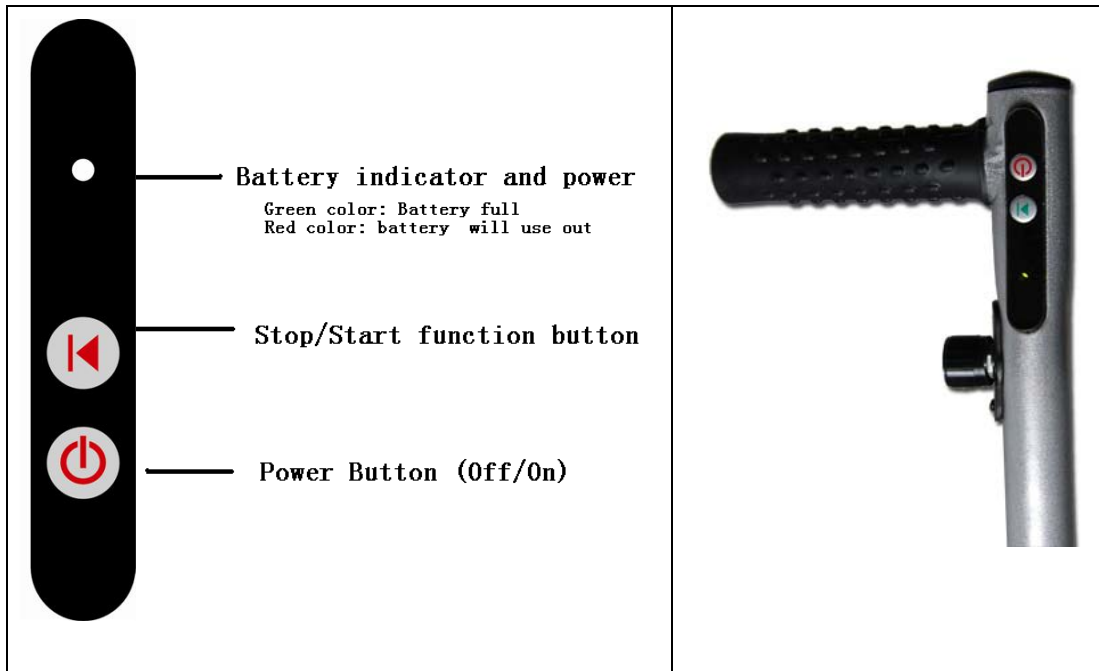

3.0 Manual Handle Control



Symbol	Function	Description
	Battery Power	Green LED: Battery is operational Red LED: Battery is low and requires recharging.
	Stop/Start	This button starts and stops the cart. Once you are ready to go, press the button, and the caddy will automatically travel at the same speed that it was previously set at (except if you change the variable speed control knob position).
	Power On/Off	Button controls the caddy's power supply. Press for 2 seconds in order to switch the caddy ON or OFF (similar to a mobile phone operation). After connecting the battery, you need to press ON, and the battery LED will illuminate. Your caddy should be ready for operation.

3.1 Variable Speed Control Knob

The manual handle controls also features a Variable Speed Control knob to increase or decrease the speed of the cart when you choose to walk-along the cart.

To speed up the cart when you are walking:

- Turn the knob forward (clockwise) to control the forward movement speed of the caddy.
- The maximum speed of the knob is set when the knob is at the 150° degree position.

To slow down or stop the caddy:

- Turn the knob backwards (counterclockwise) to slow down or stop the caddy (when the knob reaches the 0° degree position).



4.0 Operating Instructions

PLEASE OBEY THESE PRECAUTIONS FOR BATTERY USE & CHARGING

- a) Please do not charge the battery in a sealed container or in upside down position. It is recommended to charge the battery in a well ventilated area.
- b) Please do not charge the battery near a heater, or where heat accumulation may occur or in direct sunshine.
- c) In order to prolong the service life of the battery, please avoid complete discharge. When the trolley is not in use for an extended period of time, it is recommended to charge the battery before storage.
- d) The battery's poles red color stands for positive, and the black for negative. In case of battery replacement please reconnect the poles of the battery correctly. Otherwise your caddy could suffer severe damage.
- e) **EXPLOSION HAZARD!** Please do not disassemble the battery or throw it into a fire.
- f) **SAFETY HAZARD! NEVER TOUCH THE ELECTRIC POLES OF THE BATTERY!!**

4.1 Battery Charging & Maintenance

Connect the battery cable plug with the charger and then plug the charger into an electrical outlet. During the charging cycle the LED on the charger will show a blinking green light (some models also have a red steady light during charging). Once the charging cycle is complete the blinking green light or the red light will turn into a steady green light. It is now suitable to unplug the charger and battery for reuse. The charging cycle can last up to 10 hours depending on the level of discharge.

Normally the battery will hold its charge for several months, and it does not have a "memory effect" and therefore can be recharged at any discharge level. It is not recommended to fully discharge the batteries, as this will shorten battery life. The battery has a normal lifespan of 400-600 charges, depending on charging frequency, storage conditions and discharge history. Replacement batteries are available from your authorized SPITZER dealer or directly from SPITZER.

RECOMMENDATIONS FOR BATTERY CHARGING & MAINTENANCE

- a. Fully charge the battery for 12 hours before the first use
- b. Do not leave the battery on the charger if it is not used for extended periods of time. It is not recommended to leave the charger on the battery for more than 12 hours.
- c. The battery will take approximately 2-3 rounds and charging cycles before it reaches its full operating potential. During the first couple of rounds it might still be below its optimal power.
- d. Always keep your battery fully charged before another game
- e. Never keep your battery connected to the grid during prolonged power outages. It might be irreversibly damaged
- f. Do not fully discharge the battery by "overplaying" it. It is recommended to recharge the battery after every 18 holes.

5.0 Caddy Self-Test (IMPORTANT)!

Please review or follow these steps and guidelines to test your caddy prior to use every time.

5.1 Non-Moving Test (Initial Test)

Before actually using the SPITZER cart for the first time, it is recommended you operate the golf cart elevated at the drive wheels to familiarize yourself with how the cart works for both remote and handle control functions. Elevate your cart with a paint can or a similar sized and strength item allowing your cart's drive wheels to freely move without touching the ground. The pictures below illustrate an example of how the cart can be elevated for this test.



5.2 Moving Test (Prior to each use)

Make sure this test is performed with the caddy in a wide and safe area, free of obstructions or valuables, such as people, parked automobiles, flowing traffic, furniture or water bodies (rivers, swimming pools etc.), steep hills, cliffs or similar hazards.

a. Manual Control Operation

Test the manual function first:

- (i) The manual functions of the caddy are controlled through the variable speed control knob on the right side of the handle. Ensure the variable speed control knob is at its “0” position. To verify, the knob should be turned counterclockwise until it stops.
- (ii) Turn the main switch to “On” (I) position.
- (iii) Turning the knob forward (clockwise) will increase the forward movement speed of the caddy.
- (iv) **To slow down or stop the caddy, turn the knob backwards (counterclockwise).**



5.3 Recommendations for Efficient and Safe Operation

- Be alert and act responsibly at all times while operating your caddy, just as you would when operating a riding cart, motor vehicle or any other type of machinery. We absolutely do not recommend the consumption of alcohol or any other impairing substances while operating our caddies.
- Do not operate the caddy with the remote control in narrow or dangerous spaces, places with valuables or any people gathering areas, such as parking lots, close to flowing traffic, bag drop-off areas, stores, driving ranges, putting greens and practice areas, pro shops, restaurants, starter areas and other areas where people or items could be harmed through an error or lack of skill in operation. In such

situations the caddy should be best operated with its manual controls or without power. **Also, please make sure to always switch off the power ("0"), disconnect the battery cable from the cart and secure the caddy when you park and leave the unit for any reason, either on or off course.**

- With its optimized balance and straight front wheel the caddy has extraordinarily narrow and responsive turning and maneuvering abilities. However, it sometimes tends to react to severe uneven weight distribution of its load or steep slope variations and follows the slope of the golf course. Therefore, please make sure the weight in your bag is distributed evenly (move heavy balls and items to both sides, or shift the bag on the caddy). Also, when operating your caddy by remote control anticipate the slope of the course in order to avoid frequent corrections in directions. In some extreme environments, such as very uneven terrain, steep hills, narrow and/or sloped cart paths, muddy areas, gravel paths, close to bunkers and hazard, around bushes and trees it is recommended to operate the caddy via manual control in order to prevent any collisions, damage or the need for complicated correction adjustment maneuvers.

6.0 Additional Functions

6.1 Free-Wheel Mode

The caddy can be operated without power. In order to activate the free wheel mode turn the main power switch into "Off" (0) position. The caddy now can be pushed manually without resistance from the drive shaft. The freewheeling mode on some models can also be activated by pulling out both rear wheels by an inch (2cm) and relocking them back into the second axle groove. Some models are equipped with both options.



6.2 Tracking Adjustment

You can adjust the tracking of your caddy by loosening the axle and the adjustment bar on the right side of the front wheel and shifting the axle accordingly.

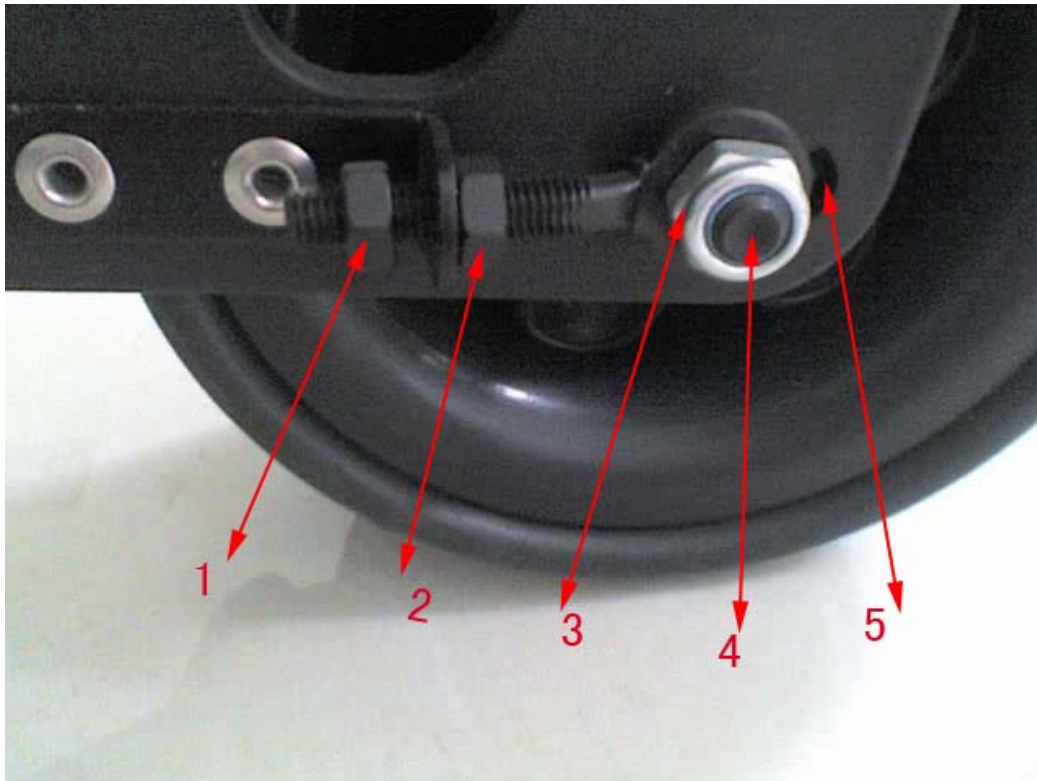

- Loosen the nuts (#3 in diagram) on the front wheel and align it. Keep the nuts (#1 and #2) on the alignment bar un-tightened.
- When the front wheel is loose, you can adjust it left or right.

- When the wheel is aligned, tighten the nut (#3) on the axle (but still keep the alignment bar's nuts loose).
- Test the cart to make sure it goes straight on an asphalt/cement flat road or pathway. If it does not, re-adjust the front wheel.
- ONLY AFTER when the cart is going straight, do you start tightening the nuts (#1 and #2) on the alignment bar. It does not need to be tight as its only purpose is to prevent the wheel from going back and forth.

7.0 General Maintenance

The steps below will ensure that you get a prolonged and reliable life out of your SPITZER EL100.

- 1) The Caddy has been designed so that the user can concentrate on playing golf, while the caddy does the work of carrying your bag. In order to keep your SPITZER EL100 looking at its best, we advise that you wipe any mud or grass from the frame, wheels and chassis after every round with a damp cloth or paper towel.
- 2) Do **NOT** use hoses or any high-pressure jet washers to prevent moisture entering the electronic systems, motors or gear boxes of the caddy.
- 3) Remove the rear wheels every few weeks and remove any debris that might cause the wheels to drag. You might also apply some lubricant, such as WD-40 to keep moving parts smooth and corrosion free.
- 4) A four - five hour round of golf played once a week for 12 months is equivalent to four years use of a lawnmower, so please inspect your cart at least once a year thoroughly, and if you notice any symptoms of wear, contact your SPITZER Service Center. Alternatively, you can have your caddy inspected and tuned by our Service Center, so it's always in great shape for the new season.
- 5) Always disconnect the battery when you store the caddy, and always put your caddy together before re-connecting the battery. If you are not planning to play for at least a month, store the battery in a warm and dry place (not on concrete floor).

All of these recommendations will help keep your SPITZER EL100 in top condition and ensure that it remains your reliable partner, both on and off the course.

8.0 Electronic Systems

- **Remote Control Range:** We recommend not to exceed 50 yards distance. The greater the distance between you and caddy, the greater the chance of losing contact with it
- **Microcomputer:** The remote caddy has 3 microcomputer controls: The first is in main controller box. The second is in the remote control transmitter handset, and the third is in the receiver in the handle.
- **Safety Protection:** When the temperature of the controller box reaches its upper limit in case of an overload it will automatically shut down to cool off.
- **Microprocessor Controlled Electronics System:** When you connect the battery, the electronics system will automatically run through a start-up routine. Then you can press the main OFF/ON switch on the handle. The battery charge indicator lights will show you the charge level of the battery from green (fully charged) to red (discharged).
- **Important:** The electronics controller box contains no user serviceable parts. Therefore, it is sealed to reduce the risk of moisture entering and impacting the electronic system. Breaking this seal increases the risk of damaging the electronics and decreasing the reliability of your caddy. **DO NOT** attempt to open the controller case. **Doing so will void the warranty!**
- **Battery Operation and Care:** Follow battery charge and maintenance instructions. The battery comes with leads and connector and a 35 Ampere fuse.

9.0 Technical Specifications EL100

Feature	Specification												
Speed Control	<ul style="list-style-type: none"> Manual Trim Dial 												
Motor	<ul style="list-style-type: none"> Power: 2 x 200 Watt (400 Watt) 24 V DC Electric 												
Drive Train	<ul style="list-style-type: none"> Direct Drive Tubular Motor System 												
Battery	<ul style="list-style-type: none"> Power: 24V Average Charge Time: 4 Hours Lifetime: 600 charges 												
Charger	<ul style="list-style-type: none"> Input: 100/240V AC Output: 24V/2A DC Trickle Charger 												
Weight	<ul style="list-style-type: none"> Net Weight Caddy: 24.0 Lbs (11 kg) Net Weight Battery: 6 Lbs (3 kg) Total Net Weight: 30 Lbs (13 kg) 												
Speed	<ul style="list-style-type: none"> 5.4 m/h (8.6 km/h) 												
Distance/Range	<ul style="list-style-type: none"> 18 Holes 												
Maximum Load	<ul style="list-style-type: none"> 55 Lbs (25 kg) 												
Climbing Ability	<ul style="list-style-type: none"> 35 degrees 												
Dimensions	<table border="1"> <thead> <tr> <th></th> <th>Full</th> <th>Folded</th> </tr> </thead> <tbody> <tr> <td>· Length</td> <td>42"</td> <td>33"</td> </tr> <tr> <td>· Width</td> <td>21"</td> <td>21"</td> </tr> <tr> <td>· Height</td> <td>35"</td> <td>10"</td> </tr> </tbody> </table>		Full	Folded	· Length	42"	33"	· Width	21"	21"	· Height	35"	10"
	Full	Folded											
· Length	42"	33"											
· Width	21"	21"											
· Height	35"	10"											
Rear Wheels	<ul style="list-style-type: none"> Airless stabilizing wheel 												
Front Wheels	<ul style="list-style-type: none"> Airless, rubberized tread 												
Materials	<ul style="list-style-type: none"> Frame: Aluminum Bag Support: ABS, Nylon 												
Colors	<ul style="list-style-type: none"> Painted: Silver Oxidized: Stainless Steel 												
Additional Accessories	<ul style="list-style-type: none"> Cup Holder Seat Umbrella Holder Carrying Bag Rain Cover Scorecard Holder 												
Warranty	<ul style="list-style-type: none"> 1 Year on Parts 												

Packaging

- Type: Cardboard Box, Styrofoam or Cardboard Cushioning
- Dimensions: 34 x 24" x 13" (88 x 60 x 31 cm)
- Gross Weight: (20 kg)

10.0 Frequently Asked Questions (FAQ)

1. **Question:** I lost my remote control handset. What shall I do?

Reply: You can purchase a new remote handset from www.spitzergolf.com. After you receive your new remote control, please connect the battery to the trolley. Turn the main switch to ON position and press and hold the forward for 6-10 seconds. The cart will move forwards once it synchronizes the remote and controller. Your new remote control should now be tuned to your caddy.



2. **Question:** When I connect the battery plug to the caddy and turn the main switch on, the battery indicator lights do not come on.

Reply: a) Inspect if the fuse in the battery case is still good, and if the battery leads are well connected to the battery.

b) Open the back of the handle with a screwdriver. Make sure the handle line plug is in the right position on the handle electronic board. It will happen when the line of the caddy is not connected in right the position.

3. **Question:** The caddy's main switch is on, and all battery indicator lights are on, but the caddy does not run or one motor does not run.

Reply: a) Please check the motor connectors on the controller box and if connector pins are in the correct position.

b) Please check the wheel is properly engaged to the axle. If the axle is turning, but the wheel is not, the wheel is not properly engaged to the axle.

4. **Question:** The manual control function works, but the remote control does not?

Reply: Please confirm that the rheostat speed knob is in Off "0" or Stop position. Also check the batteries in your remote control handset. If it still does not work open up the remote control and check the connection.

5. **Question:** The caddy does not respond well to the remote control handset?

Reply: Please check the condition of the handset batteries. Make sure you don't exceed the range distance limit. Resynchronize the remote by following the steps in Section 7.2 (Controller/ Remote Frequency Adjustment)

6. **Question:** The trolley stops by itself.

Reply: Please check the battery charge. Also the controller box has a shut-down function, if the battery is too low or the controller is overheating or the caddy does not receive a signal for a while.

7. **Question:** The caddy tracks to one side.

Reply: Please make sure that the weight distribution of your golf bag is balanced on

the caddy. To adjust the tracking loosen the axle screw of the front wheel on the right side, and adjust the wheel position accordingly. Tighten the axle screw after the adjustment to make sure the front wheel stays in the desired position. See Section 6.3 (Tracking Adjustment) for more details.

SUPPORT INFORMATION

**FOR ANY FURTHER INFORMATION OR SUPPORT ISSUES, PLEASE CALL
SPITZER GOLF AT 1-800-814-6536 OR EMAILS WILL BE PROMPTLY
RESPONDED TO AT SUPPORT@SPITZERPRODUCTS.COM**