

RCS Outdoor Rated Ice Maker

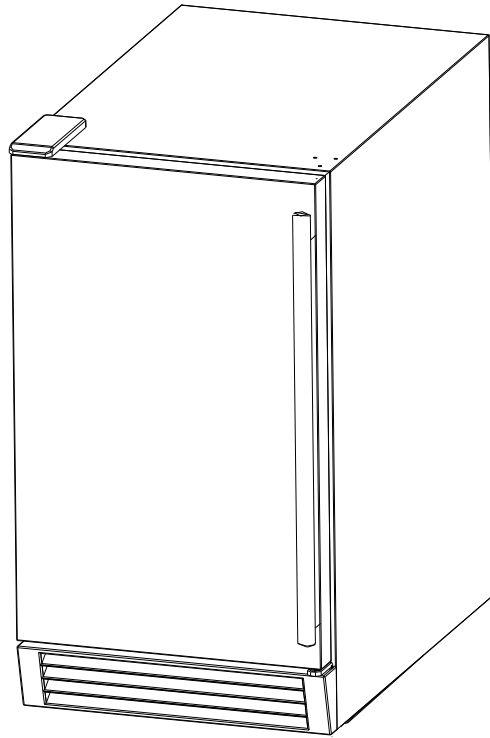

User's Manual

Be sure ice maker is standing upright 24 hours prior to plug-in.

Model: REFR3

TABLE OF CONTENTS

	Page
ICE MAKER SAFETY	2
IMPORTANT SAFEGUARDS	3 - 5
TECHNICAL INFORMATION	5
COMPONENT LOCATIONS	6
ICE MAKER INSTALLATION	7 - 14
Unpacking	7 - 8
Location requirements.....	8 - 9
Electrical requirements.....	9 - 10
Leveling the ice maker	10
Reversing the door swing.....	10 - 11
Water supply	12
Drain.....	12 - 13
Installation types	14
OPERATION	15 - 18
Final check list before operation.....	15
Operating method.....	15 - 16
How the machine makes ice.....	16
How the machine uses the water.....	16 - 17
Normal sounds	17
Preparing the ice maker for long storage	17 - 18
CLEANING AND MAINTENANCE	18 - 23
Exterior cleaning	19
Interior cleaning	19
Condenser cleaning	20
Water distribution tube cleaning	20
Ice-making system cleaning.....	20 - 21
Control Panel.....	22
Ice Size Adjustment Guide.....	22 - 23
MAJOR FUNCTIONS.....	23
TROUBLESHOOTING	24 - 25

We reserve the right to make changes in specifications and design without prior notice.

ICE MAKER SAFETY

Your safety and the safety of others are very important.

We have provided many important safety messages in this manual and on your appliance. Always read and obey all safety messages.



This is the Safety Alert Symbol. This symbol alerts you to potential hazards that can injure or kill you and others.

All safety messages will follow the Safety Alert Symbol and either the words "**DANGER**", "**WARNING**" OR "**CAUTION**".



DANGER means that failure to heed this safety statement may result in severe personal injury or death.



WARNING means that failure to heed this safety statement may result in extensive product damage, serious personal injury or death.



CAUTION means that failure to heed this safety statement may result in minor or moderate personal injury, or property or equipment damage.

All safety messages will alert you to what the potential hazard is, tell you how to reduce the chance of injury, and let you know what can happen if the instructions are not followed.

IMPORTANT SAFETY INSTRUCTIONS

WARNING: To reduce the risk of fire, electric shock or injury when using your ice maker, follows these basic precautions:

- Plug into grounded 3-prong outlet.
- Do not remove grounding prong.
- Do not use an adapter.
- Do not use an extension cord.
- Disconnect power before cleaning.
- Disconnect power before servicing.
- Replace all panels before operating.
- Use two or more people to move & install ice maker.

SAVE THESE INSTRUCTIONS

IMPORTANT SAFEGUARDS



Before the ice maker is used, it must be properly positioned and installed as described in this manual, so read the manual carefully. We strongly recommend that you have a professional install your new machine. The warranty may be affected or voided by an incorrect installation. To reduce the risk of fire, electrical shock or injury when using the ice maker, follow basic precautions, including the following:

DANGER

- Plug into a grounded 3-prong outlet; do not remove grounding prong, do not use an adapter, and do not use an extension cord.
- It is recommended that a separate circuit, serving only your ice maker, be provided. Use receptacles that cannot be turned off by a switch or pull chain.
- Do not connect or disconnect the electric plug when your hands are wet.
- Never unplug the ice maker by pulling on the power cord. Always grip the plug firmly and pull straight out from the outlet.
- Never clean ice maker parts with flammable fluids. Do not store or use gasoline or other flammable vapors and liquids in the vicinity of this or any other appliances. The fumes can create a fire hazard or explosion.
- Before proceeding with cleaning and maintenance operations, make sure the power line of the unit is disconnected and the water line is shut off.
- Before operating, pull all panels back into place.
- Never allow children to operate, play with or crawl inside the ice maker.
- Do not touch the evaporator with your hand when the machine is operating.
- Unplug the ice maker or disconnect power before cleaning or servicing. Failure to do so can result in electrical shock or death.
- Do not attempt to repair or replace any part of your ice maker unless it is specifically recommended in this manual. All other servicing should be referred to a qualified technician.

WARNING

- Use two or more people to move and install the ice maker. Failure to do so can result in back or other injury.
- To ensure proper ventilation for your ice maker, the front of the unit must be completely unobstructed. Choose a well-ventilated area with temperatures above 45°F (7°C) and below 110°F (43°C).
- Placing the ice maker at least 24" from high heat sources (fireplaces, grills, ovens, etc.) will ensure minimal energy consumption.
- The ice maker must be installed with all electrical and water connections in accordance with state and local codes. A standard electrical supply (115 V AC, 60 Hz, 15 A), properly grounded in accordance with the National Electrical Code and local codes and ordinances, is required.

- Do not kink or pinch the power supply cord between the ice maker and cabinet.
- The fuse (or circuit breaker) size should be 15 amperes.
- It is important for the ice maker to be leveled in order to work properly. Otherwise water may not flow properly through the evaporator (ice mold). The ice production will be less than normal. You may need to make several adjustments to level it.
- All installations must be in accordance with local plumbing code requirements.
- Make certain that hoses are not pinched, kinked or damaged during installation.
- Check for leaks after water line is connected.
- Although the unit has been tested and cleaned at the factory, due to long-term transit and storage, the first batch of cubes must be discarded.
- Remove the packing materials and clean the ice maker before using.
- Turn on the water supply tap before switching on the ice maker. Never turn the water supply tap off when the ice maker is working.
- Except to take ice from the unit, keep the door closed in order to reduce ice melting and to promote proper ice formation.
- If the ice maker will not be used for a long time, before the next use it must be thoroughly cleaned. Follow carefully any instructions provided for cleaning or use of sanitizing solution. Do not leave any solution inside the ice maker after cleaning.
- DO NOT use solvent-based cleaning agents or abrasives on the interior. These cleaners may transmit taste to the ice cubes, or damage or discolor the interior.
- The ice machine cleaner contains acids. Do not use or mix with any other solvent-based cleaning products. Use rubber gloves to protect hands. Carefully read the safety instructions on the container of the ice machine cleaner.
- Do not use the apparatus other than for its intended purpose.

SAVE THESE INSTRUCTIONS

Electrical Connection

Do not, under any circumstances, cut or remove the third (ground) prong from the power cord. For personal safety, this appliance must be properly grounded. The power cord of this appliance is equipped with a 3-prong grounding plug that mates with a standard 3-prong grounding wall outlet to minimize the possibility of electric shock hazard from the appliance. Have the wall outlet and circuit checked by a qualified electrician to make sure the outlet is properly grounded. When a standard 2-prong wall outlet is encountered, it is your responsibility and obligation to have it replaced with a properly grounded 3-prong wall outlet. The ice maker should always be plugged into its own individual electrical outlet which has a voltage rating that matches the rating label on the appliance. This provides the best performance and also prevents overloading house wiring circuits which could cause a fire hazard from overheated wires. Never unplug your ice maker by pulling on the power cord. Always grip the plug firmly and pull straight out from the outlet. Repair or replace immediately all power cords that have become frayed or otherwise damaged. Do not use a cord that shows cracks or abrasion damage along its length or at either end. When moving the ice maker, be careful not to damage the power cord.

Extension Cord

Because of potential safety hazards under certain conditions, it is strongly recommended that you do not use an extension cord with this ice maker.

TECHNICAL INFORMATION

Model:	REF3
Electrical power:	115VAC ~ 60Hz
Power consumption:	12.2 kWh/100 lbs of ice
Ice-making /-harvest rated current:	3.0A/3.6A
Refrigerant:	R134a, 3.17 oz
High/Low side pressure:	350 psig/130 psig
Width x depth x height:	14.6" × 23.6" × 33.5"
Unit weight:	84 lbs
Maximum ice storage:	25 lbs
Ice-making capacity:	50 lbs/day*
Ice shape:	Cube
Ice cube dimensions:	3/4" x 3/4" x 1"

The technical data and performance index listed above should be used for reference only. They are subject to change.

*The actual quantity of ice produced per day can vary with environment and water conditions.

COMPONENT LOCATIONS

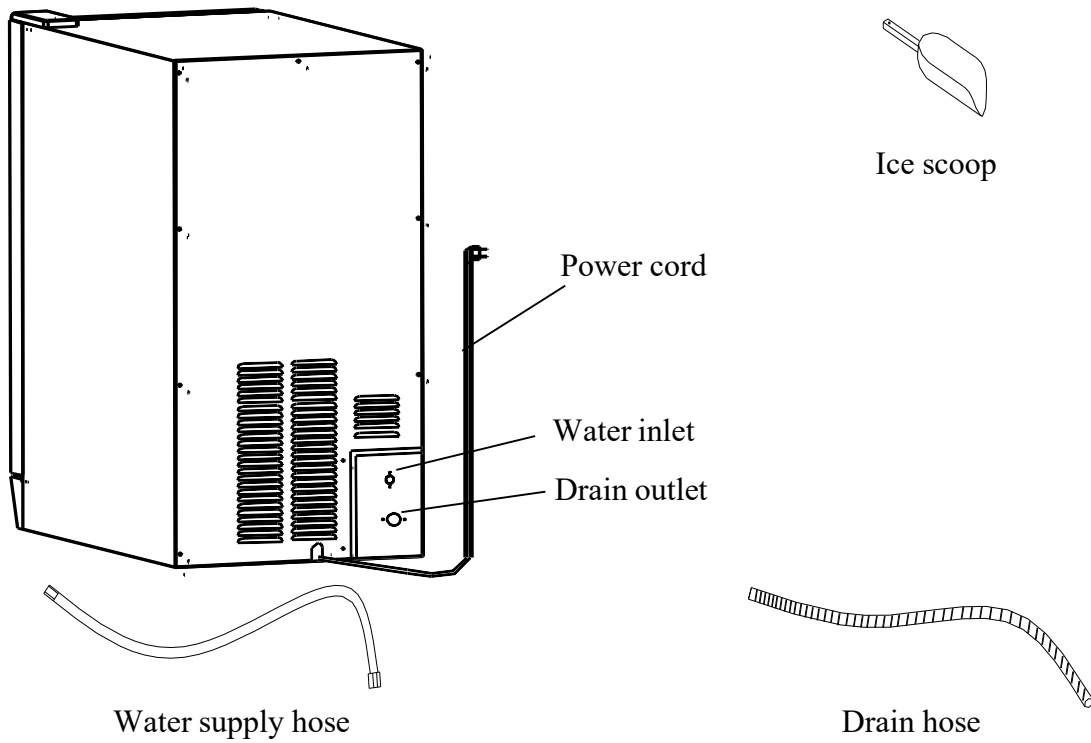
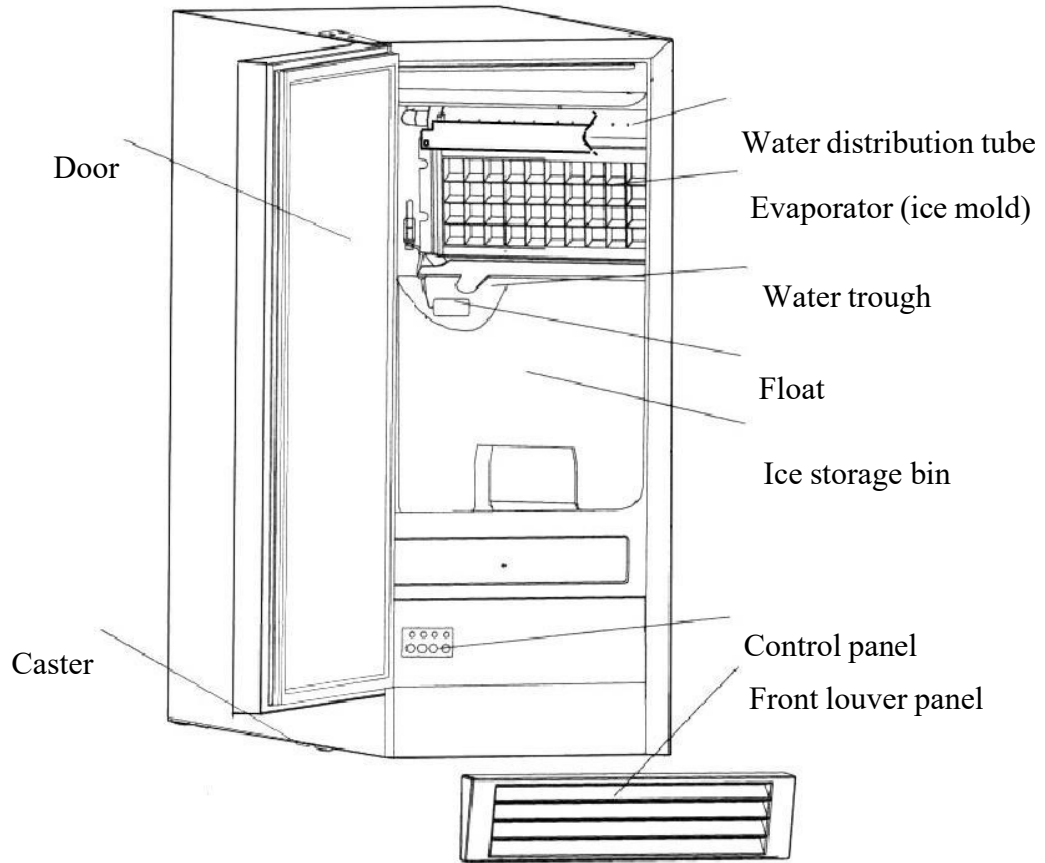

ICE MAKER INSTALLATION

Unpacking

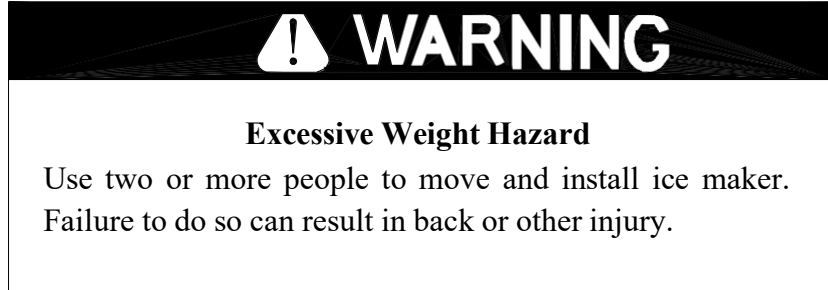

Remove packaging materials.

IMPORTANT: Do not remove any permanent instruction labels or the data label on your ice maker.

Remove tape and glue from your ice maker before using.

- To remove any remaining tape or glue, rub the area briskly with your thumb. Tape or glue residue can also be easily removed by rubbing a small amount of liquid dish soap over the adhesive with your fingers. Wipe with warm water and dry.
- Do not use sharp instruments, rubbing alcohol, flammable fluids, or abrasive cleaners to remove tape or glue. These products can damage the surface of your ice maker.

Cleaning before use

After you remove all of the packaging materials, clean the inside of your ice maker before using it. See the "Interior cleaning" in the *Cleaning and Maintenance* section.

- This ice maker should be properly installed by qualified personnel.
- To ensure proper ventilation for your ice maker, the front of the unit must be completely unobstructed.
- When installing the ice maker under a counter, follow the recommended spacing dimensions shown. Allow at least 4" (102 mm) of clearance at rear, and 1" (25 mm) at sides for proper air circulation. The installation should allow the ice maker to be pulled forward for servicing if necessary.
- Choose a well ventilated area with temperatures above 45°F (7°C) and below 110°F (43°C).
- Placing the unit at least 24" from high heat sources (fireplaces, grills, ovens, etc.) will ensure minimal energy consumption.
- Installation of the ice maker requires a cold water supply inlet of ¼-in. (6.35mm) soft copper tubing with a shut-off valve.
- The ice maker requires a continuous water supply with a minimum pressure of 15 psig and a static pressure not to exceed 80 psig. The temperature of the water feeding into the ice maker should be between 41°F (5°C) and 90°F (32°C) for proper operation.



WARNING

Normal operating ambient temperature should be between 45°F (7°C) to 110°F (43°C). Normal operating water temperature should be between 41°F (5°C) and 90°F (32°C). Operation of the ice maker for extended periods outside of these normal temperature ranges may affect production capacity.

- *It is strongly recommended that a water filter be used.* A filter, if it is of the proper type, can remove taste and odors as well as particles. Some water is very hard, and softened water may result in white, mushy cubes that stick together. Deionized water is not recommended.
- Before connecting water connection, turn on water supply and let the water run for 3 minutes before connecting ice maker to water supply.
- The ice maker must be installed with electrical and water connections in accordance with all state and local codes.
- The unit should be located on a firm and level surface. It is important for the ice maker to be leveled in order to work properly. If needed, you can adjust the height of the ice maker by revolving the caster. See the *Leveling the Ice Maker* section.
- A standard electrical supply (115V AC only, 60Hz, 15A), properly grounded in accordance with the National Electrical Code and local codes and ordinances, is required.

IMPORTANT: Do not kink or pinch the power supply cord between the icemaker and wall or cabinet

Electrical requirements

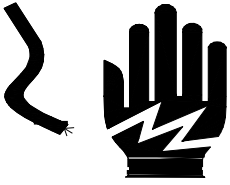
 DANGER 

<p>Electrical Shock Hazard</p> <p>Plug into a grounded 3-prong outlet. Never remove the ground prong from the plug. Never use an adapter. Never use an extension cord. Failure to follow these instructions can result in fire, electrical shock or death.</p>

Before you move your ice maker into its final location, it is important to make sure you have the proper electrical connection:

A standard electrical supply (115V AC only, 60Hz, 15A), properly grounded in accordance with the National Electrical Code and local codes and ordinances, is required. The ice maker should always be plugged into its own individual electrical outlet.

It is recommended that a separate circuit, serving only your ice maker, be provided. Use a receptacle that cannot be turned off by a switch or pull chain.

The fuse (or circuit breaker) size should be 15 amperes.

Recommended grounding method

For your personal safety, this appliance must be grounded. This appliance is equipped with a power supply cord having a 3-prong grounding plug. To minimize possible shock hazard, the cord must be plugged into a mating 3-pronged and grounding-type wall receptacle, grounded in accordance with the National Electrical Code and local codes and ordinances. If a mating wall receptacle is not available, it is the personal responsibility of the customer to have a properly grounded, 3-prong wall receptacle installed by a qualified electrician.

Leveling the ice maker

It is important for the ice maker to be leveled in order to work properly. Otherwise water will not flow properly through the evaporator (ice mold). The ice production will be less than normal, and may be noisy. The unit can be raised or lowered by rotating the plastic sheaths around each of the four rolling casters on the bottom of the machine. If you find that the surface is not level, rotate the casters until the ice maker becomes level. You may need to make several adjustments to level it. We recommend using a carpenter's level to check the machine.

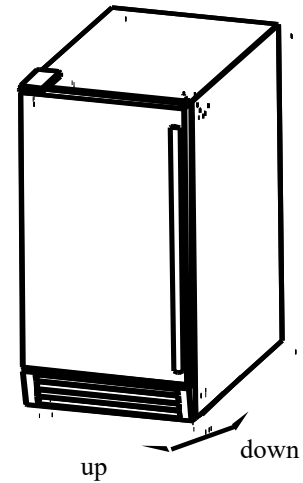

1. Place a carpenter's level on top of the unit to see if the ice maker is level from front to back and side to side.
2. Adjust the height of the casters as follows:
 - Turn the leveling casters to the right to lower that side of the ice maker.
 - Turn the leveling casters to the left to raise that side of the ice maker.

You will find that the casters make it easy for one person to move the machine. This is useful for cleaning and sanitizing the surface on which the ice maker is installed because it allows you to move the unit and have easy access to the surface to be cleaned.

IMPORTANT: When the ice maker is ready to be installed in a cabinet or directly on the floor, you must adjust the feet to level the ice maker and lock the rollers. If the floor is level, just revolve the two front feet to touch the floor.

Reversing the door swing

Tools needed: flathead screwdriver, Phillips screwdriver

IMPORTANT: *Before you begin, unplug the ice maker or disconnect power.*

To remove door from hinges:

1. Remove top hinge cover by pushing it toward the back of the unit, then lifting it off.
2. Using a Phillips screwdriver, remove the screws, then remove the top hinge mat and top hinge. Keep the parts together and set them aside.
3. Lift the door off of the bottom hinge and set the door aside.

To replace door on hinges:

1. Using a flathead screwdriver, remove the plug buttons from the screw holes opposite the door hinges, top and bottom. Set aside.
2. Remove the front louver. Set aside.
3. Remove the bottom hinge and place it on the opposite side at the bottom of the door.
4. Position the door on the bottom hinge.
5. Align the door on the bottom hinge and replace the top hinge and top hinge mat.
6. Replace top hinge cover by pressing it down over the hinge mat and then pushing it forward.
7. Push the plug buttons into the original screw holes.

See Figure below.

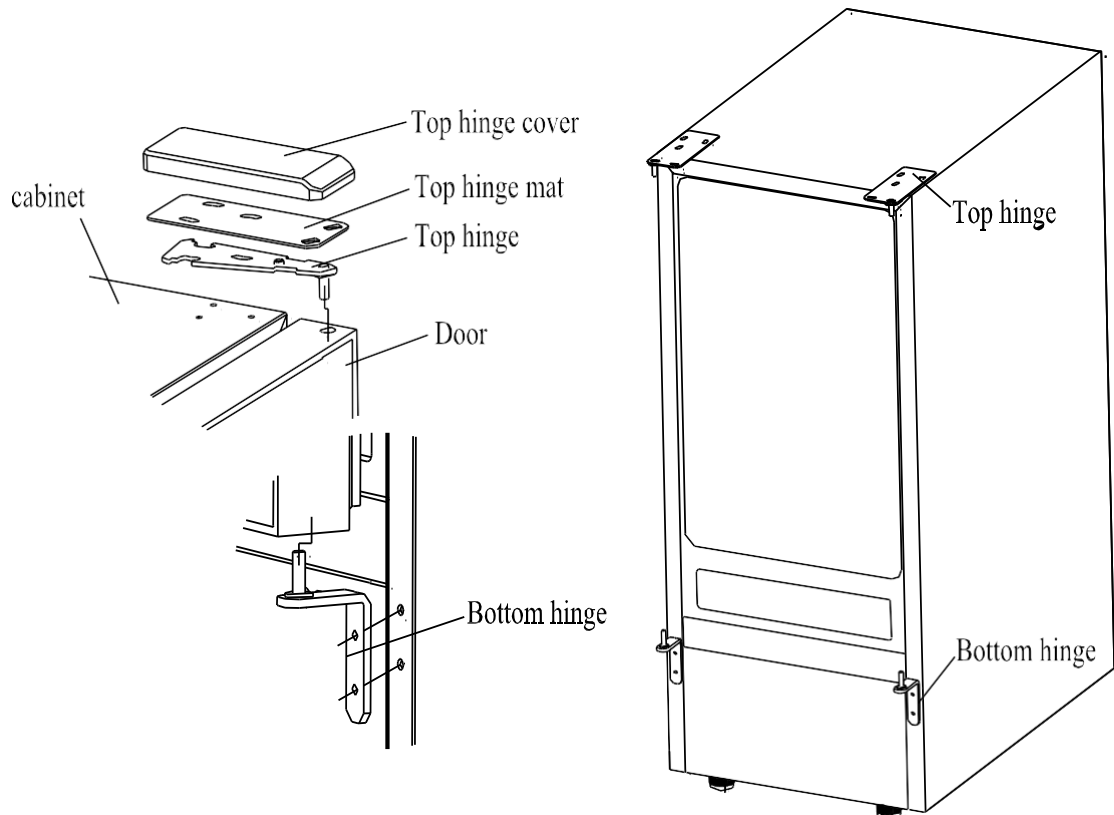

Water Supply

The water supply should be ready at the point of installation. The water supply pressure should be a minimum of 15 psig with a static pressure not more than 80 psig. (A wall outlet directly behind the ice machine will make installation easier.)

IMPORTANT:

1. *Let water supply run for 5 minutes before connecting water supply to ice maker.*
2. *All installations must be in accordance with local plumbing code requirements. Professional installation is recommended.*
3. *Make certain the hoses are not pinched or kinked or damaged during installation.*
4. *Check for leaks after connection.*

Tools required:

½-in. open-end wrench, Phillips screwdriver

Connecting the water line:

1. Turn off main water supply. Turn on the nearest faucet long enough to clear line of water and debris for 3 minutes.
2. Find a ½-in. to ¾-in. vertical cold water pipe near the installation location. The distance should be less than 9 feet. The water supply hose provided with the ice maker is about 9 feet long.
3. A shut-off valve must be installed to the main water supply. If the water pipe has a plain piece of copper tubing, attach a ¼" O.D. compression union to the tubing and remove the nut.
4. Connect the nut of the water supply hose to the tap, and connect the other end with the water inlet. Tighten firmly by hand, then one-half turn with wrench.
5. Turn on main water supply and tap. Check for water supply connection leaks. Tighten every connection (including connection at the water inlet).

IMPORTANT: When you connect the water supply hose and the drain hose, pay attention to the indications of "Water inlet" and "Drain outlet" on the machine.

Drain

You must connect the drain line before using the ice maker. (The Dual Drainage feature of earlier models has been modified to simplify the drainage procedure.) Follow the steps outlined below.

Connecting the drain line:

NOTE: If there is a drain line near the ice maker, the best choice is to drain water to the drain line through the drain water hose provided with ice maker.

1. Locate the floor drain near the ice maker. The distance should be less than 5 feet since the length of the long drain water hose provided with the ice maker is about 5 feet.
2. Find the drain outlet on the back of ice maker. Connect the drain outlet to the water draining hose, and insert the other end of the hose into the drain line.

NOTE: Never allow the drain hose to hang or loop higher than the floor of the ice storage bin.

3. All horizontal runs of drain lines must have a fall of ¼” per foot. An air gap will likely be required between the ice maker drain tube and the drain/waste receptacle. A standpipe with a trap below it would be acceptable for the drain/waste receptacle. A floor drain is also acceptable. If this is not possible, the use of a condensate pump is recommended.
4. Pour 1 gallon of water into the ice storage bin to check for leaks in the drainage system. Tighten any connections that leak.

IMPORTANT: This ice maker is not a freezer. Infrequent drainage will cause a high rate of melting in the ice storage bin.

Installation Types

This ice maker has been designed for Mobile (free-standing) installation. However, it can also be Enclosed (as under a cabinet) or Built-in (sealed to the floor). In any case, there must be adequate air space around the unit for ventilation.

Mobile installation:

A mobile installation will allow you to install the ice maker free-standing in any place you desire provided you have access to a water supply. You must follow the stated instructions for

- a. Electrical requirements
- b. Water supply
- c. Leveling the ice maker.

Enclosed Installation:

An enclosed installation will allow you to install the ice maker under a cabinet or in a kitchen cabinet provided the required clearance space around the ice maker is respected. This installation has the same requirements as a mobile installation.

Built-in installation:

If this method of installation is chosen, it will still be necessary to allow adequate ventilation space around the unit. The following additional items must be observed.

1. Place ice maker in front of installation location. Remove the feet and place the unit flat on the floor or on a platform depending on your installation requirements.
2. The water supply line must be plumbed before connecting to the ice maker.
3. Turn on main water supply and tap. Check for water supply connection leaks. Tighten every connection (including connection at the water inlet).
4. If the electrical outlet for the ice maker is behind the cabinet, plug in the ice maker.
5. Push the ice maker into position.
6. Seal all around the cabinet to the floor with an approved caulking compound.

IMPORTANT: Be sure the drain hose is connected and fed into the drain line before the ice maker is moved into its final position.

OPERATION

Final Check List before Operation

1. Have all packing materials and tape been removed from the interior and exterior of the ice maker?
2. Did you clean the ice storage bin?
3. Did you let the water supply run for 5 minutes before connecting water connection?
4. Have the installation instructions been followed, including connecting the machine to water and electricity?
5. Has the machine been leveled?
6. Is the ice maker in a site where the ambient temperature is between 45°F (7°C) and 110°F (43°C) and the water temperature between 41°F (5°C) and 90°F (32°C) all year-round?
7. Has the water supply pressure been checked to ensure a minimum of 15 psig with a static pressure not to exceed 80 psig?
8. Is there a clearance of at least 4" (102mm) at the rear, and 1" (25 mm) at top and sides for proper air circulation?
9. Has the power supply voltage been checked or tested against the nameplate rating? And has proper grounding been installed in the ice maker?
10. Is the ice maker plugged in?
11. Have you turned on the main water supply and tap?
12. Have you checked for leaks at all water supply connections?

Operating method

1. Turn on the water tap, let the water trough fill, then press the ON/OFF button on the front panel. The ice maker will start working automatically.

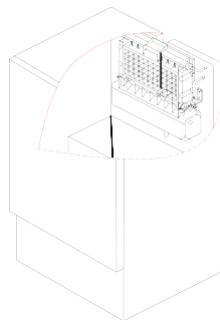

Ice making stage

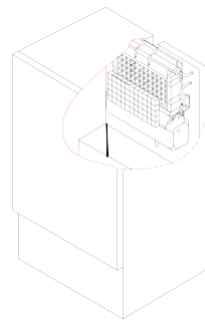

Ice harvest stage

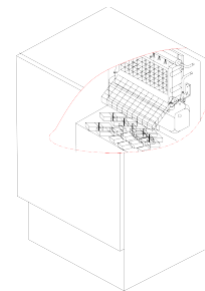

Bin full stage

2. After 3 minutes, the machine will automatically go to the ice-making stage, and the sound of water flowing will be heard.

3. When the batch of ice has been fully formed, ice will automatically be harvested to the

ice storage bin.

4. When the ice storage bin is full, the sheet of cubes will not fall completely and will hold the bin-full probe open. The machine stops making ice automatically.
5. The unit will start making ice again after the ice cubes are removed. Then the bin-full probe swings back to operating position.

IMPORTANT:

- *Although the unit has been tested and cleaned at the factory, due to long-term transit and storage, the first batch of cubes must be discarded.*
- *Never turn the water supply tap off when the ice maker is working.*
- *Never touch evaporator when unit is running!*
- *Except to take ice from the unit, keep the door closed to reduce melting and insure proper ice formation.*

How the machine makes ice

Set the ON/OFF button to the ON position. The machine will automatically go to the ice making stage.

There are two distinct cycles: ice freeze and harvest.

The freeze cycle happens when water flows to the evaporator surface. The harvest cycle is when the ice is released and water enters the machine. A complete cycle takes about 20 minutes, but it depends on temperature and operating conditions.

Freeze: During the freeze cycle the compressor is pumping refrigerant, the fan motor is blowing air, and the water pump is circulating water. When the batch of ice has been fully formed, the ice maker stops the freeze cycle and the harvest cycle begins.

Harvest: During the harvest cycle the compressor is still operating, but the water pump has stopped. The hot gas valve opens, diverting hot refrigerant gas into the evaporator. The hot refrigerant gas warms the evaporator, causing the cubes to slide as a unit off the evaporator and into the storage bin. The freeze cycle will restart when all the cubes have been harvested.

How the machine uses the water

The ice maker begins with a fixed charge of water that is contained in the water trough. As the water flows to the freezing evaporator surface, the portion of water that does not contain mineral impurities freezes and sticks to the ice cube molds. The water containing impurities falls back into the water trough. During the ice making process, fresh water enters into the water trough continuously as the water in the trough freezes continuously in the evaporator.

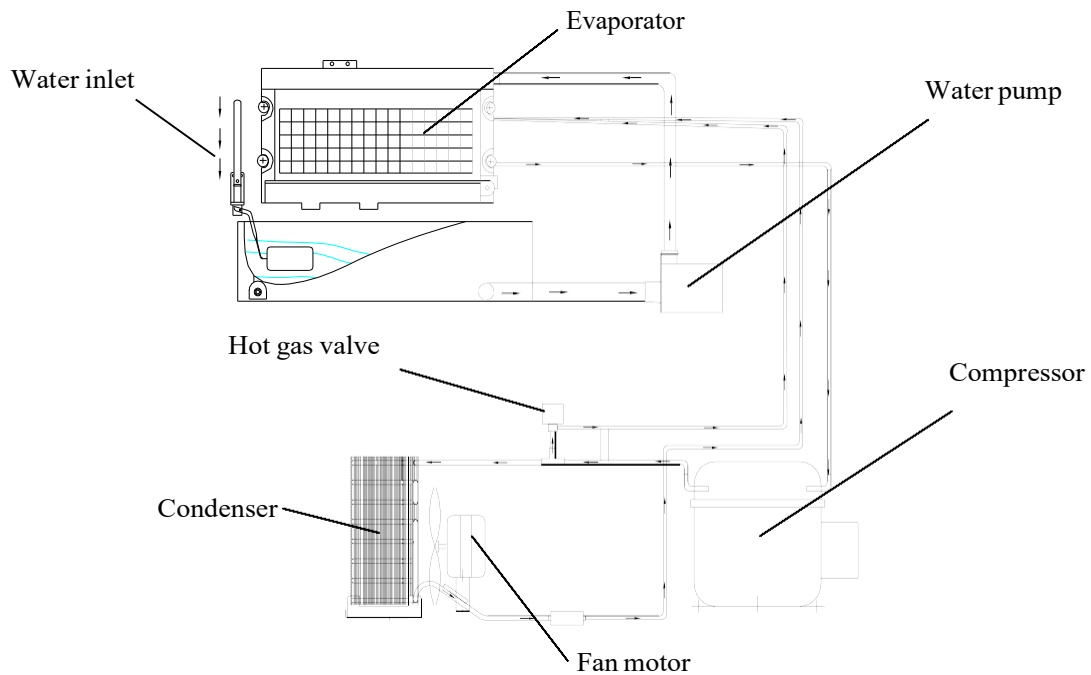

Normal sounds

Your new ice maker may make sounds that are not familiar to you. Most of the new sounds are normal. Hard surfaces like the floor and walls can make the sounds louder than they actually are. The following list describes the sounds that might be new to you and what may be causing them.

- Rattling noises may come from the flow of the refrigerant or the water line. Items stored on top of the ice maker can also make noises.
- The high efficiency compressor may make a pulsating or high-pitched sound.
- Water running may make a splashing sound.
- You may hear air being forced over the condenser by the condenser fan.
- During the harvest cycle, you may hear the sound of ice cubes falling into the ice storage bin.

Preparing the ice maker for long storage

If the ice maker will not be used for a long time, or is to be moved to another place, it will be necessary to drain the system of water.

1. Shut off the water supply at the main water source.
2. Disconnect the water supply line from the water inlet.
3. Shut off the electric supply at the main electrical power source.
4. Take out the ice storage bin to remove any remaining ice and water. Dry the bin.
5. Pull off the drainage tube of the water trough to drain off all water.

6. Leave the door open to allow for circulation and to prevent mold and mildew.
7. Leave water supply line and power cord disconnected until ready to reuse.

IMPORTANT:

- *Do not touch the power plug when your hands are wet.*
- *Never unplug the unit by pulling on the cord. Grasp the plug and pull out firmly.*

CLEANING AND MAINTENANCE

CAUTION

If the ice maker is left unused for a long time, before the next use it must be thoroughly cleaned. Follow carefully any instructions provided for cleaning or use of sanitizing solutions. Do not leave any solution inside the ice maker after cleaning.

Periodic cleaning and proper maintenance will ensure efficiency, top performance, and long life. The maintenance intervals listed are based on normal conditions. You may want to shorten the intervals if you have pets, or there are other special considerations.

What shouldn't be done

Never keep anything in the ice storage bin that is not ice: objects like wine and beer bottles are not only unsanitary, but the labels may slip off and plug up the drain.

What parts should be kept clean

There are 5 things to keep clean:

1. The exterior
2. The interior
3. The condenser
4. Water distribution tube
5. The ice-making system

 **WARNING**

Before proceeding with cleaning and maintenance operations, make sure the power line of the unit is disconnected and the water line is shut off.

Exterior cleaning

The door and cabinet may be cleaned with a mild detergent and warm water solution such as 1 oz. of dishwashing liquid mixed with 2 gallons of warm water. Do not use solvent-based or abrasive cleaners. Use a soft sponge and rinse with clean water. Wipe with a soft clean towel to prevent water spotting. Stainless steel can discolor when exposed to chlorine gas and moisture. Clean stainless steel with a mild detergent and warm water solution and a damp cloth. Never use an abrasive cleaning agent.

Interior cleaning

The ice storage bin should be sanitized occasionally. Clean the water trough before the ice maker is used first time and reused after stopping for an extended period of time. It is usually convenient to sanitize the trough after the ice making system has been cleaned, and the ice storage bin is empty.

1. Disconnect the power to the unit.
2. Open the door and take out the removable ice storage bin. With a clean cloth, wipe down the interior of unit and ice bin with a sanitizing solution made of 1 ounce of household bleach or chlorine and 2 gallons of hot (95°F – 115°F) water.
3. Rinse thoroughly with clear water.
4. Screw off the drainage nut to drain completely.
5. Put the ice storage bin inside the unit.
6. Reconnect power to the unit.

The ice scoop should be washed regularly. Wash it just like any other food container.

 **WARNING**

DO NOT use solvent-based cleaning agents or abrasives on the interior. These cleaners may transmit taste to the ice cubes and damage or discolor the interior.

Condenser cleaning

A dirty or clogged condenser prevents proper airflow, reduces ice making capacity, and causes higher than recommended operating temperatures that may lead to component failure. Have the condenser cleaned at least once every six months.

1. Unplug the ice maker or disconnect power.
2. Gently pull off the lower front louver.
3. Remove dirt and lint from the condenser and the unit compartment with the brush attachment of a vacuum cleaner.
4. Reassemble the lower front louver.
5. Plug in the ice maker or reconnect power.

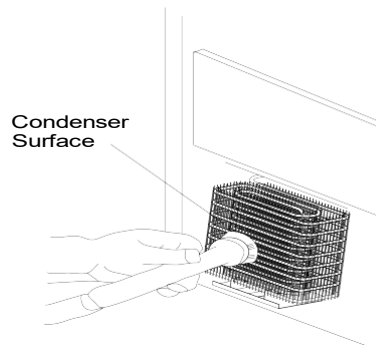

Water distribution tube cleaning

When you find the ice cubes are incompletely formed or the output is low, the water distribution tube may be blocked. Turn off the power button, gently take out the water distribution tube, locate the holes in the distribution tube and use a pointed object such as a toothpick to dredge the holes. Then put the water distribution tube back to its original position. If the tube is badly blocked, clean it as follows:

1. Shut off the water supply
2. Disconnect the water hose from the distribution tube.
3. Gently take out the distribution tube.
4. With a brush, clean the tube with a dilute solution of warm water and a mild detergent such as dishwashing liquid. After removing the dirt and lint from the surface, rinse the tube with clean water.
5. Replace the distribution tube.
6. Reconnect the water supply.

Ice-making system cleaning

Minerals that are removed from the water during the freezing cycle will eventually form a hard, scaly deposit in the water system. Cleaning the system regularly helps remove the mineral scale buildup. How often to clean the system depends upon how hard your water is or how effective your filtration may be. With hard water of 15 to 20 grains/gal. (4 to 5 grains/ liter), you may need to clean the system as often as once every 6 months.

1. Make sure that all the ice is off the evaporator. If ice is being formed, wait until the cycle is completed, then press the machine's ON/OFF switch on the control panel.
2. Remove all ice from the storage bin.
3. Keep the ice maker connected to the water supply. Pour 8 oz. of Nickel-Safe Ice

Maker Cleaner Solution into the water trough. Then press the ON/OFF switch and the CLEAN button, initiating the wash cycle. The machine will run in the Automatic Clean Mode.

4. Allow 30 minutes for proper cleaning. After cleaning, press the ON/OFF switch again. Use a drain hose on the front of the water trough to drain off the waste water to a convenient container.

NOTE: Don't drain off the waste water to the inside of the cabinet.

5. Repeat steps 3 and 4 (without Ice Maker Cleaning Solution) three times to rinse the ice making system thoroughly.

- *NOTE: Ice Maker Cleaner Solution in the water bin during the rinse is not needed.*

 **WARNING**

The ice machine cleaner contains acids.
DO NOT use or mix with any other solvent-based cleaner products.
Use rubber gloves to protect hands. Carefully read the material safety instructions on the container of the ice machine cleaner.
Discard the first batch of ice produced after cleaning.

6. Prepare a sanitizing solution made of 1 ounce of household bleach and 2 gallons of hot water (95°F to 115°F). Wipe the entire bin inside and outside, covering the entire surface of the walls.
7. Fill a spray bottle with the sanitizing solution and spray all corners and edges, making sure to cover all surfaces with the solution.
8. Allow the solution to be in contact for at least 3 minutes, then dry.
9. Repeat step 5 to rinse the ice making system one more time.
10. Press the ON/OFF button again. The machine will return to the regular ice making mode. Discard the first batch of ice.

Control panel:

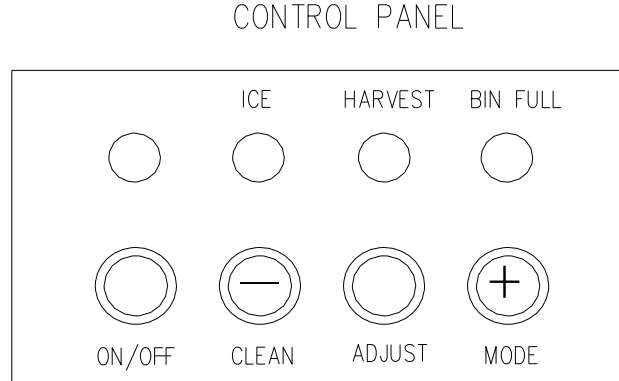

Description of LEDs and buttons:

1. **Bin Full (Red) LED:** Bin full indicator light

When this is lit, the ice storage bin is full of ice or there is something blocking the bin-full probe. The unit will stop working. When ice cubes are removed from the ice storage bin, freeing the bin-full probe, the red LED will remain flashing for 3 minutes, then the unit will restart and return to the ice making mode.

2. **Ice Making (Green) LED:** Ice making indicator light

When this is lit, the unit is working in the ice making mode controlled by a temperature probe on the evaporator. When the green LED flashes, the unit is working in the ice making mode controlled by a fixed timer.

3. **Ice Harvest (Yellow) LED:** Ice harvest indicator light

When this is lit, the unit is working in the ice harvest mode controlled by the ice-full probe.

4. **Mode button:** Mainly for service. When this is pressed, the ice making mode changes to the ice harvest mode or vice versa. The mode can be judged from the status of the green and yellow LEDs.

5. **Adjust button:** Mainly for service. When it is pressed over 3 seconds, the unit will enter the Ice Size Adjustment mode. The mode can be judged from the status of the yellow LEDs.

Ice Size Adjustment Guide:

1. Press and hold the “**Adjust**” button for at least 3 seconds. The unit will enter the Ice Size Adjustment mode. The “**HARVEST**” LED (yellow) will be blinking continuously during the ice size adjustment. Release the button when the LED blinks continuously to adjust the ice size.

2. While in the Ice Size Adjustment mode, press the “Clean” (-) button or the “Mode” (+) button for the desired ice size.

Smaller ice setting:

By pressing the “Clean” (-) button, you can decrease the size of the ice cubes. The “ICE” LED (green) will flash as you lower the ice size and will finally be blinking at the setting of smallest ice size.

Larger ice setting:

By pressing the “Mode” (+) button, you can increase the size of the ice cubes. The “BIN FULL” LED (red) will flash as the larger size is set and will blink when the setting of largest ice size has been reached.

After 10 seconds without any operation, the unit will return to the previous mode.

NOTE:

- If during the ice size adjustment mode the “BIN FULL”, “ICE” and “HARVEST” LEDs blink all at once, this indicates that the unit is in the regular (middle) setting of the ice size.
- When the machine is in the cleaning stage or ice full stage, the ice size adjustment mode cannot be accessed

MAJOR FUNCTIONS

1. The operating procedure is completely automatic.
2. When the ice storage bin is full of ice cubes, the machine stops making ice automatically. It starts making ice again after ice cubes are removed.
3. The different colors of the LED display indicate various work modes.
4. A sensitive probe and accurate timer enhance the performance of the ice maker.
5. A compressor protection system is built in.

TROUBLESHOOTING

Before Calling for Service

If the unit appears to be malfunctioning, read through the *OPERATION* section of this manual first. If the problem persists, check the Troubleshooting Guide on the following pages. Some of the problems mentioned in the Guide can be solved easily without a service call.

Troubleshooting Guide

Problem	Possible Cause	Probable Correction
The machine doesn't operate.	The ice maker is unplugged.	Plug the ice maker in.
	The fuse is blown.	Replace fuse. If it happens again, call for service to check for a short circuit in the unit.
	The ice maker power button is set at OFF.	Switch the ice maker power button to ON.
	The ice storage bin is full of ice.	Remove some ice cubes. Be sure the ice-full probe is free of ice.
The water doesn't feed in after the machine starts.	The water supply tap is turned off.	Turn on the water supply tap.
	The water supply pipe is not properly connected.	Reconnect the water supply pipe.
Machine makes ice, but bin does not fill up with ice.	The condenser may be dirty.	Clean the condenser.
	The air flow to the ice maker may be obstructed.	Check the installation.
	The ambient temperature and water temperature are high, or unit is near some heat source.	Check the installation.
Water is leaking out of the unit.	Some water falls to the floor when you open the door to remove ice from storage bin.	Normal condensation on the door or some water together with ice. Take care when you take out ice.
	Water supply connection is leaking.	Tighten fitting. See <i>Connecting the water line</i> .
	Drain pipe higher than drain outlet.	Lower drain pipe.

Cubes are partially formed or are white on the bottom.	Not enough water in the water trough.	Check if the water supply pressure is below 15 psig.
		Check water supply or filter may be restricted.
		Check for a water leak at the water trough.
Noise during operation	The feet are not leveled and locked.	Level and lock the feet. See <i>Leveling the Ice Maker</i> .
	Certain sounds are normal.	See <i>Normal Sounds</i> .
The ice maker stops suddenly while making ice.	The electricity is off.	Reconnect the power supply line.
	The environment temperature is out of the stated range.	Cut off the electricity and leave the ice maker disconnected until the temperature returns to within the stated range.
	The ice storage bin is full of ice.	Remove some ice cubes; make sure the ice-full probe is free of ice.
The body of the ice maker is electrified	The ground line isn't in the socket.	Use a socket meeting the grounding requirements.
Scaling occurs frequently inside the machine.	The hardness level of the water is too high.	Install a water-softening device in front of the water inlet.
Water leaks from the ice storage bin	The drainhole below the ice storage bin is blocked.	Remove the ice storage bin and clean the drainhole.
	The drain hose is kinked or improperly placed higher than the floor of the ice storage bin.	Check the drain hose to be sure water can be drained out unhindered.
Ice is partially forming or freezing to evaporator	Debris in the water line	Remove debris from internal water line. Check the screen in the float valve
Water is not freezing the water, not producing ice	Compressor Relay's or Compressor has failed	If the ice maker is plugged in, and the compressor is hot, the compressor has failed. If the ice maker is plugged in and the compressor is cold, the relay's need to be replaced