

systemer®

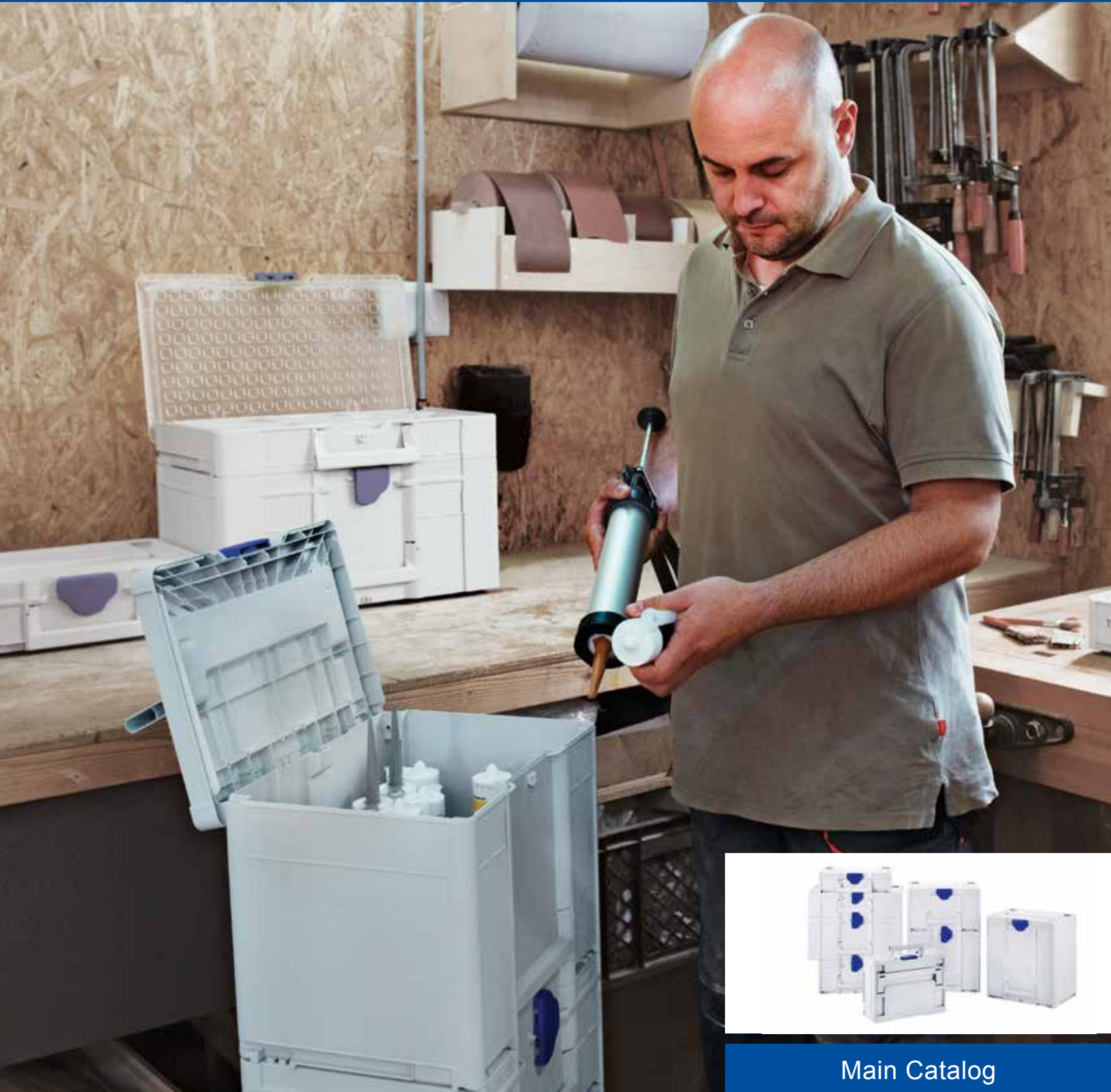

[Main Catalog](#)

TANOS

TANOS

systainer®

FROM THE PAST TO THE FUTURE

TANOS GmbH was founded in 1993 as a subsidiary of TTS Tooltechnic Systems AG & Co. KG. Developing and distributing the systainer® product range is our passion. Secure packaging and clear organization of your work materials and tools, and saving time during transportation – systainer® products provide all of these benefits and more. As the inventors of this unique, patented case system, we have created cases that can be stacked and linked together. Our concept makes a systainer® more than just a case: It's a system!



1993 systainer® Classic-Line

The systainer® success story begins. Thanks to TANOS systainer® products are available to everyone.



1995

Cool down:
The first insulated systainer® makes its way to the customer.

1 millionth

systainer® sold in 1996.

2000

Adding big and small options to the family:
MINI- and MAXI-systainer® Classic-Line.

2001

Smart sorting:
With the Drawer-systainer®.

2008

Intelligent additions:
systainer® Classic-Line II with lid sort-tray and Rack-systainer®.

10 millionth

systainer® sold in 2008.

2010 systainer® T-Loc

Global debut:
Market launch of the second systainer® generation with unique T-Loc central controller.



● 2013

Three new products:
MIDI-systainer® T-Loc, systainer® Tool-Box
and Storage-Box.

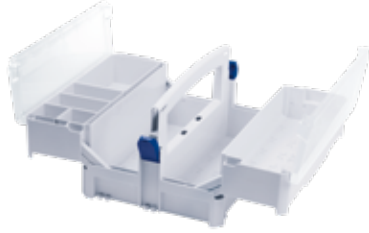

systainer® Storage-Box

● 20 millionth

systainer® sold in 2015.

● 2015

User-friendly:
Introductions of systainer® T-Loc "SYS-Combi"
and Sortainer T-Loc "SYS-Sort".



systainer® T-Loc "SYS-Combi II"

● 2017

The success story continues:
MINI-systainer® T-Loc with transparent lid
and MINI-systainer® T-Loc III.

● 25 millionth

systainer® sold in 2018.

● 2018

TANOS goes USA:
The founding of TANOS Inc./USA ensures systainer® is now directly
available in the USA as well.

● 2018

New standard for mobile work:
The mobile workshop MW 1000.



● 2019

Systainer³

**Market launch of the innovative third generation:
100 % mobile, simply practical, better in a system.
Cooperation between TANOS, bott and Festool
to develop a comprehensive, consistent mobility
concept.**



● 2020

The Systainer³ system has been awarded the
German Design Award Winner 2020 for outstanding
design quality.



UNIQUE. PATENTED. UNSURPASSED.
STACKABLE. LINKABLE. THE systemer®
IS NOT JUST A CASE, IT'S A SYSTEM.



Systainer³



Even more reliable, with more functions and broader applications – that's Systainer³. The third generation stands for even better mobility with a comprehensive mobility concept. Enjoy the advantages you trust with the Systainer³: T-Loc central controller, compatible with one another and connectable with all previous systemer® generations.



systemer® T-Loc



Just one touch is all you need! Systematically stack individual systemer® and lock them with a flick of the wrist – this generation offers innovative T-Loc central controller technology: lock, open, connect. The second generation combines innovation with function and attractive design.



systemer® Classic-Line



Proven top class quality! Our systemer® Classic-Line has been accompanying millions of satisfied customers through their everyday work for many years. Of course, it can be combined with all other systemer® generations.

TANOS systainer®	Page 6 - 15
systainer® applications	Page 6 - 7
More than just a box	Page 8 - 9
systainer® system partners	Page 10 - 11
Systainer³ the new generation	Page 12 - 15
systainer® PRODUCT RANGE	Page 20 - 55
Empty-systainer®, sets and inserts	Page 20 - 51
systainer® additions and accesories	Page 51 - 55



TANOS

systainer®

A SMALL SELECTION OF
systainer® APPLICATIONS



A SOLUTION FOR ANY JOB



TRADES

Whether you're a do-it-yourselfer or an nationwide trade company, the systainer® is custom-tailored to fulfill your needs and requirements.



INDUSTRY

If you want to sell and present your products with a high-quality image, the systainer® is a perfect building block in your brand strategy.



MEDICAL

Safety and reliability in transportation and handling are essential in the medical field. A systainer® impresses everywhere and anytime.

IN USE EVERYWHERE

Your systainer® system offers an endless range of potential applications, in many different industries and sectors. Clearly, systainer® products are a popular choice in trades and industrial applications. But systainer® are also an all-around system built to handle specialized demands and requirements. Innovative developments, accessories, variables, a variety of internal features and easy linking options make the systainer® a smart system for your needs.



SALES REPRESENTATIVE EQUIPMENT

Put your products in the limelight! systainer® offers individual, customized solutions for product presentation, for even more successful field sales.



SPORTS & LEISURE

Whether sport fishing or climbing – a systainer® is the perfect choice to store all your sporting equipment in one place.

TANOS

systainer®

STACKABLE AND LINKABLE

Individual systainer® can be combined, securely stacked, firmly linked and can still be operated individually at the same time.



TRANSPORT OPTIMIZATION

Standardized dimensions allow boxes to be stacked, saving volume and cash during transportation on pallets – whether in a truck, a warehouse, or a retail store.

ABS* PLASTIC

The best base material combined with a sturdy design offers outstanding structural strength.

systainer® are formstable and impact-resistant. Contents are effectively protected against dust and moisture.



*ABS = Acrylnitril-Butadien-Styrol



DESIGNED IN GERMANY

DEVELOPED IN HOUSE

Our research and development department with highly qualified engineers and product managers works continuously on the innovative further development of our products with ISO 9001 certification.

HIGHLY AUTOMATED PRODUCTION

Thanks to standardized processes, we guarantee consistent, high product quality and quality controlling in Germany and Europe.

ENVIRONMENT & SUSTAINABILITY

The systainer® produced from recyclable ABS ensure more environmentally friendly, recyclable packaging you can use for years, and therefore help to avoid waste.

MORE THAN JUST A BOX

Today, flexibility on the job is essential. Each and every systainer® is not just a case, but rather part of a cleverly designed system. This allows you to prepare for and react optimally to your work needs. The different possible combinations, and variable interior options for your systainer® are virtually endless. Easily change the arrangement of your systainer® tower to meet your personal needs. All systainer® are stackable and linkable!



AWARD-WINNING systainer® T-LOC SYSTEM

Multiple awards and consistently positive test results are truly a reflection of the enthusiasm for innovative technologies and the long-lasting, high quality standard of this system.



STILL THE ORIGINAL

The entire systainer® portfolio is fully protected by a various property rights. The original systainer® is and remains an original. You can rely on that.

TANOS

systemer®

systemer® SYSTEM PARTNERS: A SMALL EXCERPT



i IMPRESSIVE NUMBERS

46 DIFFERENT systemer® VARIATIONS

Innovation and creativity are the drivers behind everything we do. We don't just want to fulfill your requirements; we also want to meet your needs.

AN ENDLESS RANGE OF COMBINATIONS

systemer® does what you want! Virtually unlimited possibilities allow for perfectly tailored customization.

EVERYTHING BUILDS ON THE systainer®

As the manufacturer of the most popular linkable case system on the market, we believe in the power of experience: To get where you're going, you've got to know where you've been! The success of the systainer® proves us, and you, right. We'd like to say a huge thank you to our customers and partners! Over 26 million systainer® sold have made our system what it is today. You can build on the systainer®, since 1993. It's here today, and it will be here tomorrow as well. We promise.



MORE THAN 26 MILLION systainer®

A big thank you to our customers and partners! The systainer® is conquering the world and we are delighted with more than 26 million sold systainer®.

3 PRODUCT LINES, 1 SYSTEM

Systainer³, systainer® T-Loc, systainer® Classic-Line: Unique, clever, stackable, and linkable. Together, on top of one another, and across brands.

**MILLIONS
OF SATISFIED
USERS SPEAK FOR
THEMSELVES.**

systemer[®]
The new generation

SYSTEMER³

CONNECTS SOLUTIONS



LINKABLE

"With systainer®, I've got a friend for life."

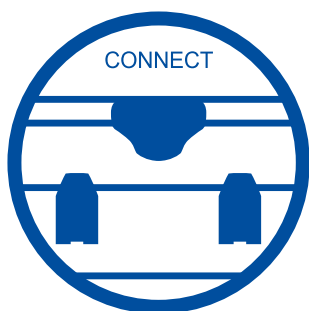

QUICK & EASY

"The systainer® makes my everyday work easier."



Trusted

T-Loc central controller

Secure

Theft-tag catch system



RELIABLE

"With systainer®, I've got a reliable partner."

MULTIFUNCTIONAL

"The systainer® does what I want."

systemer®

The new generation

THE SYSTEMER® MODULAR, STACKABLE STORAGE CASE SYSTEM

German engineered and designed to maximize interior useable space and minimize exterior space needed for storage: Organize and store your contents while optimizing space and increasing efficiency

GERMAN
quality & design



Ultra convenience with 2 handles (only with Systainer³ heights 112-187).



Remove from shelves easily with the additional pull-out handle and existing lid handle



Systainer³ load capacity up to 88 lbs and lid load up to 220 lbs



Protect your contents with the integrated Theft tag

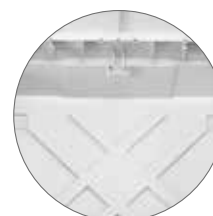

Durable and Sturdy: Reinforced ABS design

LONG-LASTING DESIGN

If it breaks, fix it! All systainer® components, such as lids, handles and catches can be replaced.

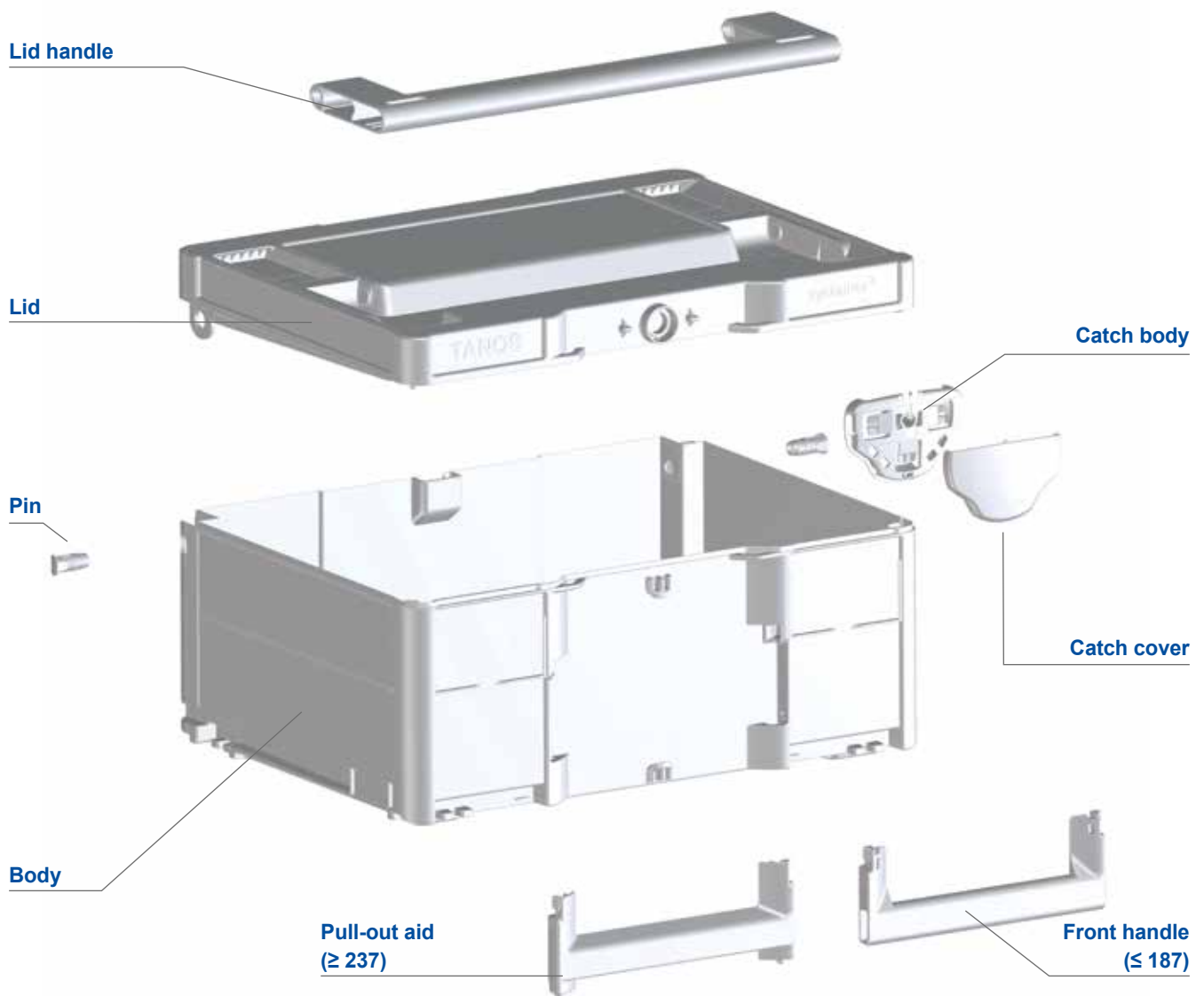

systemer®

Mobile Workshop

FLEXIBLE AND MOBILE ON THE GO

As the manufacturer behind the systemer® connectable storage system – which has sold millions of units to date – we always have our eye on the latest trends. Today, flexibility and mobility are central facets of everyday work for most tradespeople. Our mobile workshop offers the flexibility you need, ensuring it is ready to use for any application. Compact, comfortable, and with maximum portability, the mobile workshop can be set up anywhere you need it. That's efficiency that pays off!



SAFE

- Safely attach work surface to the cart for transportation using the integrated strap



MULTIFUNCTIONAL

- Flexible clamping mounts on all sides
- Can be connected to additional work tables (TSB/1-MW 1000) on all sides
- Even, stable and consistent work surface



EASY TO USE

- Simple to handle and transport, even on your own



STURDY

- Adjustable feet
- Cart stands on four feet – not on the rollers

Robust: Trolley and wheels easily handle uneven surfaces



Independent: The mobile workshop is ready to use whenever and wherever you need it



Sturdy: The stable construction ensures optimal working conditions anywhere



Ready to go! Quick storage and everything in place for the next job site



FLEXIBLE

- Integrated MDF work surface for safely attaching additional systainer® (suitable for all systainer® generations.)



ORGANIZED

- Stable drawer (SYS-AZ-MW 1000)
- Perfect fit for mounting systainer® with base area of W 396 x D 296 mm
- Custom fitting with drawers
- Variable height adjustment without tools



RELIABLE

- T-Loc catch to attach the systainer® to the mobile workshop



PRACTICAL

- Easily load into a vehicle with sliding surfaces on the handle



INTUITIVE

- Three different position settings – locks automatically



STURDY

- Large rubber wheels, 200 mm diameter for easily climbing stairs, without gravel residue or visible wear to floors

CLEVER

- Storage for MINI-systainer® T-Loc I in the base tray
- Additional drawer can be retrofitted (SYS-AZ art. no. 80101664)



systemer[®]

Product range



OUR PRODUCT RANGE

EMPTY-**systainer**[®], SETS AND INSERTS

systainer[®] dimensions



Page 20 - 21

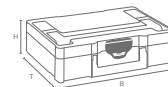

Systainer³ M



Page 22 - 33



Systainer³ L



Page 34 - 39



Systainer³ XXL



Page 40 - 41



Systainer³ Organizer



Page 42 - 43



SYS-Combi, SYS-Sort



Page 44 - 45



MINI-systainer[®]



Page 46 - 49



systainer[®] Tool-
and Storage-Box



Page 50 - 51



systainer[®] ADDITIONS AND ACCESSORIES

Labelling

Page 52



Mobile work

Page 53



Spares

Page 54 - 55



systemer®

Empty-systemer®

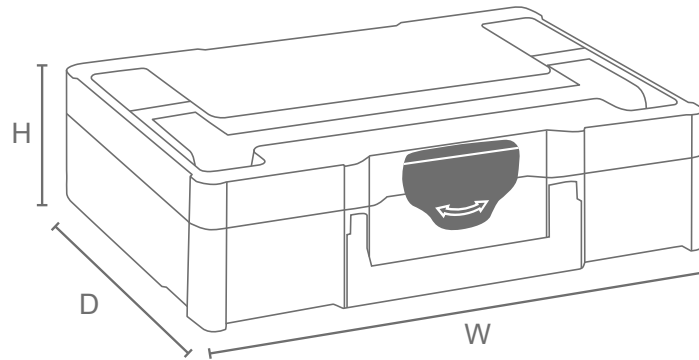

Systemer³



	Outside H* x W x D	Inside H x W x D	Weight	Inner volume	Pallet Pcs. / H.
Systemer³ M 112 1)	4.13" x 15.59" x 11.65"	2.80" x 15.33" x 10.83"	3.086 lbs	2.034 gal	128 / 72.32"
Systemer³ M 137 2)	5.12" x 15.59" x 11.65"	3.78" x 15.33" x 10.83"	3.307 lbs	2.747 gal	104 / 72.72"
Systemer³ M 187 3)	7.09" x 15.59" x 11.65"	5.75" x 15.34" x 10.83"	3.726 lbs	4,200 gal	72 / 69.96"
Systemer³ M 237 4)	9.06" x 15.59" x 11.65"	7.72" x 15.34" x 10.83"	4.167 lbs	5.653 gal	56 / 69.57"
Systemer³ M 337 5)	12.99" x 15.59" x 11.65"	11.65" x 15.34" x 10.83"	5.181 lbs	8.559 gal	40 / 71.14"
Systemer³ M 437 6)	16.93" x 15.59" x 11.65"	15.51" x 15.34" x 10.83"	6.371 lbs	11.386 gal	32 / 73.90"



	Outside H* x W x D	Inside H x W x D	Weight	Inner volume	Pallet Pcs. / H.
Systemer³ L 137 7)	5.12" x 20.00" x 11.65"	3.70" x 19.74" x 10.83"	4.233 lbs	3.487 gal	52 / 72.72"
Systemer³ L 187 8)	7.09" x 20.00" x 11.65"	5.67" x 19.75" x 10.83"	4.718 lbs	5.336 gal	36 / 69.96"
Systemer³ L 237 9)	9.06" x 20.00" x 11.65"	7.64" x 19.75" x 10.83"	5.247 lbs	7.238 gal	28 / 69.57"



	Outside H* x W x D	Inside H x W x D	Weight	Inner volume	Pallet Pcs. / H.
Systemer³ XXL 237 10)	9.06" x 31.18" x 11.65"	7.40" x 30.96" x 10.99"	8.025 lbs	11.174 gal	28 / 69.57"
Systemer³ XXL 337 11)	12.99" x 31.18" x 11.65"	11.34" x 30.95" x 10.99"	9.546 lbs	16.960 gal	20 / 71.14"



	Outside H* x W x D	Inside H x W x D	Weight	Inner volume	Pallet Pcs. / H.
Systemer³ Organizer M 89 12)	3.23" x 15.59" x 11.65"	2.36" x 15.33" x 9.69"	3.527 lbs	1.955 gal	160 / 72.32"
Systemer³ Organizer L 89 13)	3.23" x 20.00" x 11.65"	2.36" x 19.74" x 10.96"	4.387 lbs	2.562 gal	80 / 72.32"

SYSTAINER® DIMENSIONS

All sizes are designed with dimensions to maximize interior useable space and minimize exterior space needed for storage.



T-Loc



1)



2)



3)

	Outside H* x W x D	Inside H x W x D	Weight	Pallet Pcs. / H.
systainer® T-Loc „SYS-Combi II“²⁾ Drawer	10.35" x 15.59" x 11.65"	5.02" x 15.08" x 10.51" 2.72" x 13.78" x 10.04"	7.05 lbs –	48 / 68.11" –
systainer® T-Loc „SYS-Combi III“³⁾ Drawer	12.40" x 15.59" x 11.65"	12.40" x 15.59" x 11.65" 2.72" x 13.78" x 10.04"	7.72 lbs –	40 / 68.11" –
Sortainer T-Loc „SYS-Sort IV/3“⁴⁾ Drawer	12.40" x 15.59" x 11.65"	– 2.72" x 13.78" x 10.04"	13.10 lbs –	40 / 68.11" –



4)



5)



6)

	Outside H* x W x D	Inside H x W x D	Weight	Pallet Pcs. / H.
MINI-systainer® T-Loc I⁴⁾	2.80" x 10.43" x 6.73"	2.09" x 10.02" x 6.08"	0.948 lbs	400 / 75.59"
MINI-systainer® T-Loc I with transparent lid⁵⁾	2.80" x 10.43" x 6.73"	2.09" x 10.02" x 6.08"	0.948 lbs	400 / 75.59"
MINI-systainer® T-Loc III⁶⁾	5.59" x 10.43" x 6.73"	4.88" x 10.02" x 6.08"	1.323 lbs	192 / 77.95"



T-Loc / Classic-Line



1)



2)



3)

	Outside H* x W x D	Inside H x W x D	Weight	Pallet Pcs. / H.
systainer® Tool-Box 1¹⁾	5.63" x 15.59" x 11.65" Height with handle*: 8.19"	–	2.90 lbs	96 / 76.77"
systainer® Tool-Box 2²⁾	9.84" x 15.59" x 11.65" Height with handle*: 12.68"	–	4.40 lbs	56 / 77.95"
systainer® Storage-Box³⁾	6.30" x 15.59" x 11.65" Height with handle*: 9.17"	–	5.50 lbs	88 / 77.17"

*The outside dimensions are measured without feet: Systainer³ M, L and XXL Systainer³ Organizer M and L, systainer® T-Loc „SYS-Combi II + III“, Sortainer T-Loc „SYS-Sort IV / 3“, systainer® Tool-Box 1 + 2, systainer® Storage-Box: H +0.28", MINI-systainer® T-Loc I + III: H +0.19"



Systainer³ M 112

Small and functional! Thanks to its low height, it is an excellent way to store things like abrasive material. The Systainer³ M 112 can be conveniently transported upright with its front handle.

Systainer³ M 112

- Light grey art n° 83000001

DIMENSIONS

Outside H* x W x D	Inside H x W x D	Weight	Carrying capacity	Inner volume	Pallet Pcs./H.
4.13" x 15.59" x 11.65"	2.80" x 15.33" x 10.83"	3.086 lbs	44 lbs	2.034 gal	128 / 72.32"

*The outside dimensions are measured without feet: H +0.28"

COLOR

	Standard colors	Additional colors	
Body with lid	1) 3)	4) 5) 6) 7) 8) 9) 10)	
Lid handle	1) 3)	4) 5) 6) 7) 8) 9) 10) 11) 12)	
Catch	2) 3)	1) 4) 5) 6) 7) 8) 9) 10) 11) 12)	
1) RAL 7035, light grey	4) RAL 9004, black	7) RAL 3002, carmine red	10) RAL 6001, emerald green
2) HKS 43 K, signal blue	5) RAL 1007, daffodil yellow	8) RAL 5015, sky blue	11) HKS 54 K, signal green
3) RAL 7016, anthracite	6) RAL 2011, deep orange	9) RAL 5003, sapphire blue	12) RAL 9016, white

Systainer³ M 112 SETS



Universal-Systainer³ M 112

- Light grey art n° 83500009
- With lid insert, EPP, 0.20" and universal insert with 10 compartments

LID INSERTS



Lid foam, vaulted
• Art n° 81200533



Office lid
• Art n° 81200535

BOTTOM INSERTS



Base foam soft, 0.98"
• Art n° 81200543



Pick & pluck foam rigid, 0.98"
• Art n° 81200544

Perforated cubes, 0.59" x 0.59",
for tearing out



Base foam with cross cut-out
• Art n° 83000037

systemer®

Empty-systainer®



Systainer³ M 137

The Systainer³ M 137 is ideally suitable for tools, hardware, office supplies, equipment, medical supplies, arts and crafts and more.

Systainer³ M 137

- Light grey art n° 83000002

DIMENSIONS

Outside H* x W x D	Inside H x W x D	Weight	Carrying capacity	Inner volume	Pallet Pcs./H.
5.12" x 15.59" x 11.65"	3.78" x 15.33" x 10.83"	3.307 lbs	44 lbs	2.747 gal	104 / 72.72"

*The outside dimensions are measured without feet: H +0.28"

COLORS

	Standard colors	Additional colors
Body with lid	1) 3)	4) 5) 6) 7) 8) 9) 10)
Lid handle		11) 12)
Catch	2)	1)
	1) RAL 7035, light grey 2) HKS 43 K, signal blue 3) RAL 7016, anthracite	4) RAL 9004, black 5) RAL 1007, daffodil yellow 6) RAL 2011, deep orange 7) RAL 3002, carmine red 8) RAL 5015, sky blue 9) RAL 5003, sapphire blue 10) RAL 6001, emerald green 11) HKS 54 K, signal green 12) RAL 9016, white

Systainer³ M 137 SETS



Padded-Systainer³ M 137

- Light grey art n° 83500015
- With base foam soft, 0.98", base pick & pluck foam rigid, 0.98" and lid foam, vaulted



Cordless drill Systainer³ M 137

- Light grey art n° 83500011
- With insert for cordless drill and lid foam, vaulted

LID INSERTS



Lid foam, vaulted
• Art n° 81200533



Office lid
• Art n° 81200535

BOTTOM INSERTS



Base foam soft, 0.98"
• Art n° 81200543



Pick & pluck foam rigid, 0.98"
• Art n° 81200544

Perforated cubes, 0.59" x 0.59",
for tearing out



Base foam with cross cut-out
• Art n° 83000037



Systainer³ M 187

With its compact dimensions, the Systainer³ M 187 adapts to your individual equipment needs. The Systainer³ M 187 is especially well suited for power tools or office materials. Upright carrying option included with the front handle.

Systainer³ M 187

- Light grey art n° 83000003

DIMENSIONS

Outside H* x W x D	Inside H x W x D	Weight	Carrying capacity	Inner volume	Pallet Pcs./H.
7.09" x 15.59" x 11.65"	5.75" x 15.34" x 10.83"	3.726 lbs	44 lbs	4.200 gal	72 / 69.96"

*The outside dimensions are measured without feet: H +0.28"

COLORS

	Standard colors	Additional colors
Body with lid	1) 3)	4) 5) 6) 7) 8) 9) 10)
Lid handle	1) 3)	4) 5) 6) 7) 8) 9) 10) 11) 12)
Catch	2) 3)	1) 4) 5) 6) 7) 8) 9) 10) 11) 12)

- 1) RAL 7035, light grey
2) HKS 43 K, signal blue
3) RAL 7016, anthracite

- 4) RAL 9004, black
5) RAL 1007, daffodil yellow
6) RAL 2011, deep orange

- 7) RAL 3002, carmine red
8) RAL 5015, sky blue
9) RAL 5003, sapphire blue

- 10) RAL 6001, emerald green
11) HKS 54 K, signal green
12) RAL 9016, white

LID INSERTS



Lid foam, vaulted
• Art n° 81200533



Office lid
• Art n° 81200535

BOTTOM INSERTS



Base foam soft, 0.98"
• Art n° 81200543



Pick & pluck foam rigid, 0.98"
• Art n° 81200544

Perforated cubes, 0.59" x 0.59",
for tearing out



Base foam with cross cut-out
Art n° 83000037



Systainer³ M 237

Optimal storage for tools or insulation for sensitive contents: that's the Systainer³ M 237. The integrated pull-out aid makes it easier to remove the case from a shelf.

Systainer³ M 237

- Light grey art n° 83000004

DIMENSIONS

Outside H* x W x D	Inside H x W x D	Weight	Carrying capacity	Inner volume	Pallet Pcs./H.
9.06" x 15.59" x 11.65"	7.72" x 15.34" x 10.83"	4.167 lbs	44 lbs	5.653 gal	56 / 69.57"

*The outside dimensions are measured without feet: H +0.28"

COLORS

	Standard colors	Additional colors
Body with lid	1) 3)	4) 5) 6) 7) 8) 9) 10)
Lid handle		11) 12)
Catch	2)	1)

- 1) RAL 7035, light grey
2) HKS 43 K, signal blue
3) RAL 7016, anthracite

- 4) RAL 9004, black
5) RAL 1007, daffodil yellow
6) RAL 2011, deep orange

- 7) RAL 3002, carmine red
8) RAL 5015, sky blue
9) RAL 5003, sapphire blue

- 10) RAL 6001, emerald green
11) HKS 54 K, signal green
12) RAL 9016, white

LID INSERTS



Lid foam, vaulted
• Art n° 81200533



Office lid
• Art n° 81200535

BOTTOM INSERTS



Base foam soft, 0.98"
• Art n° 81200543



Pick & pluck foam rigid, 0.98"
• Art n° 81200544

Perforated cubes, 0.59" x 0.59",
for tearing out



Base foam with cross cut-out
• Art n° 83000037



Set of 3 dividers
• Art n° 83500054



Systainer³ M 337

Flying high with the Systainer³ M 337. With its impressive height, it offers lots of interior space for hand tools and tall materials. It is optimally suited for insulating cartridges, spray cans and sensitive contents.

Systainer³ M 337

- Light grey art n° 83000005

DIMENSIONS

Outside H* x W x D	Inside H x W x D	Weight	Carrying capacity	Inner volume	Pallet Pcs./H.
12.99" x 15.59" x 11.65"	11.65" x 15.34" x 10.83"	5.181 lbs	44 lbs	8.559 gal	40 / 71.14"

*The outside dimensions are measured without feet: H +0.28"

COLORS

	Standard colors	Additional colors
Body with lid	1) 3)	4) 5) 6) 7) 8) 9) 10)
Lid handle	1) 3)	4) 5) 6) 7) 8) 9) 10) 11) 12)
Catch	2) 3)	1) 4) 5) 6) 7) 8) 9) 10) 11) 12)

- 1) RAL 7035, light grey
2) HKS 43 K, signal blue
3) RAL 7016, anthracite

- 4) RAL 9004, black
5) RAL 1007, daffodil yellow
6) RAL 2011, deep orange

- 7) RAL 3002, carmine red
8) RAL 5015, sky blue
9) RAL 5003, sapphire blue

- 10) RAL 6001, emerald green
11) HKS 54 K, signal green
12) RAL 9016, white

LID INSERTS



Lid foam, vaulted
• Art n° 81200533



Office lid
• Art n° 81200535

BOTTOM INSERTS



Base foam soft, 0.98"
• Art n° 81200543



Pick & pluck foam rigid, 0.98"
• Art n° 81200544

Perforated cubes, 0.59" x 0.59",
for tearing out



Base foam with cross cut-out
• Art n° 83000037



Systainer³ M 437

The tallest Systainer³ offers plenty of space for large work materials and tools, and is optimally suited for insulating cartridges, spray cans and sensitive contents or packaging large objects.

Systainer³ M 437

- Light grey art n° 83000006

DIMENSIONS

Outside H* x W x D	Inside H x W x D	Weight	Carrying capacity	Inner volume	Pallet Pcs./H.
16.93" x 15.59" x 11.65"	15.51" x 15.34" x 10.83"	6.371 lbs	44 lbs	11.386 gal	32 / 73.90"

*The outside dimensions are measured without feet: H +0.28"

COLORS

	Standard colors	Additional colors
Body with lid	1) 3)	4) 5) 6) 7) 8) 9) 10)
Lid handle	1) 3)	4) 5) 6) 7) 8) 9) 10) 11) 12)
Catch	2) 3)	1) 4) 5) 6) 7) 8) 9) 10) 11) 12)
	1) RAL 7035, light grey 2) HKS 43 K, signal blue 3) RAL 7016, anthracite	4) RAL 9004, black 5) RAL 1007, daffodil yellow 6) RAL 2011, deep orange 7) RAL 3002, carmine red 8) RAL 5015, sky blue 9) RAL 5003, sapphire blue 10) RAL 6001, emerald green 11) HKS 54 K, signal green 12) RAL 9016, white

Systainer³ M 437 SETS



Cartridge-Systainer³ M 437*

- Light grey art n° 83500029
- With EPP cartridge insert



Aerosol-Systainer³ M 437**

- Light grey art n° 83500033
- With EPP spray can insert



Insulated Systainer³ M 437 EPP

- Light grey art n° 83500041
- With EPP insulating insert and insulating lid

LID INSERTS



Lid foam, vaulted
• Art n° 81200533



Office lid
• Art n° 81200535

BOTTOM INSERTS



Base foam soft, 0.98"
• Art n° 81200543



Pick & pluck foam rigid, 0.98"
• Art n° 81200544

Perforated cubes, 0.59" x 0.59",
for tearing out



Base foam with cross cut-out
• Art n° 83000037



Divider for Insulated Systemer³
• Art n° 83500066
• Set of 2

systemer®

Empty-systemer®



Systainer³ L 137

If you need a little extra storage space: Systainer³ L 137. The Systainer³ L 137 offers the best possible tool storage for your needs, as well as convenient carrying upright using the front handle.

Systainer³ L 137

- Light grey art n° 83000007

DIMENSIONS

Outside H* x W x D	Inside H x W x D	Weight	Carrying capacity	Inner volume	Pallet Pcs./H.
5.12" x 20.00" x 11.65"	3.70" x 19.74" x 10.83"	4.233 lbs	44 lbs	3.487 gal	52 / 72.72"

*The outside dimensions are measured without feet: H +0.28"

COLORS

	Standard colors	Additional colors	
Body with lid	1) 3)	Additional colors upon request	
Lid handle		4) 5) 6) 7) 8) 9) 10) 11) 12)	
Catch	2)	1)	
1) RAL 7035, light grey	4) RAL 9004, black	7) RAL 3002, carmine red	10) RAL 6001, emerald green
2) HKS 43 K, signal blue	5) RAL 1007, daffodil yellow	8) RAL 5015, sky blue	11) HKS 54 K, signal green
3) RAL 7016, anthracite	6) RAL 2011, deep orange	9) RAL 5003, sapphire blue	12) RAL 9016, white

Systainer³ L 137 SETS



Universal-Systainer³ L 137

- Light grey art n° 83500043
- With lid insert, EPP, 0.20" and universal insert with 6 compartments



Padded-Systainer³ L 137

- Light grey art n° 83500045
- With base foam soft, 0.98", base pick & pluck foam rigid, 0.98", and lid foam, vaulted

LID INSERTS



Lid foam, vaulted

• Art n° 81200537

BOTTOM INSERTS



Base foam soft, 0.98"

• Art n° 81200536



Pick & pluck foam rigid, 0.98"

• Art n° 81200538

Perforated cubes, 0.59" x 0.59",
for tearing out



Systainer³ L 187

Tools, angle grinders and much more, everything has its place in the Systainer³ L 187. Carry upright or easily link to a tower; transportation is easy with the Systainer³ L 187.

Systainer³ L 187

- Light grey art n° 83000008

DIMENSIONS

Outside H* x W x D	Inside H x W x D	Weight	Carrying capacity	Inner volume	Pallet Pcs./H.
7.09" x 20.00" x 11.65"	5.67" x 19.75" x 10.83"	4.718 lbs	44 lbs	5.336 gal	36 / 69.96"

*The outside dimensions are measured without feet: H +0.28"

COLORS

	Standard colors	Additional colors	
Body with lid	1) 3)	Additional colors upon request	
Lid handle		4) 5) 6) 7) 8) 9) 10) 11) 12)	
Catch	2)	1)	
1) RAL 7035, light grey	4) RAL 9004, black	7) RAL 3002, carmine red	10) RAL 6001, emerald green
2) HKS 43 K, signal blue	5) RAL 1007, daffodil yellow	8) RAL 5015, sky blue	11) HKS 54 K, signal green
3) RAL 7016, anthracite	6) RAL 2011, deep orange	9) RAL 5003, sapphire blue	12) RAL 9016, white

Systainer³ L 187 SETS



Tool-Systainer³ L 187

- Light grey art n° 83500047
- With 2 tool lids and tool insert with dividers

LID INSERTS



Lid foam, vaulted

• Art n° 81200537

BOTTOM INSERTS



Base foam soft, 0.98"

• Art n° 81200536



Pick & pluck foam rigid, 0.98"

• Art n° 81200538

Perforated cubes, 0.59" x 0.59",
for tearing out

systemer®

Empty-systemer®



Systainer³ L 237

The Systainer³ L 237 offers additional space. Large equipment or utensils fit into this tool case. Just like all Systainer³ L sizes, it can also be linked to the Systainer³ M size and systemer® T-Loc.

Systainer³ L 237

- Light grey art n° 83000009

DIMENSIONS

Outside H* x W x D	Inside H x W x D	Weight	Carrying capacity	Inner volume	Pallet Pcs./H.
9.06" x 20.00" x 11.65"	7.64" x 19.75" x 10.83"	5.247 lbs	44 lbs	7.238 gal	28 / 69.57"

*The outside dimensions are measured without feet: H +0.28"

COLORS

	Standard colors	Additional colors	
Body with lid	1) 3)	Additional colors upon request	
Lid handle		4) 5) 6) 7) 8) 9) 10) 11) 12)	
Catch	2)	1)	
1) RAL 7035, light grey	4) RAL 9004, black	7) RAL 3002, carmine red	10) RAL 6001, emerald green
2) HKS 43 K, signal blue	5) RAL 1007, daffodil yellow	8) RAL 5015, sky blue	11) HKS 54 K, signal green
3) RAL 7016, anthracite	6) RAL 2011, deep orange	9) RAL 5003, sapphire blue	12) RAL 9016, white

LID INSERTS



Lid foam, vaulted

• Art n° 81200537

BOTTOM INSERTS



Base foam soft, 0.98"

• Art n° 81200536



Pick & pluck foam rigid, 0.98"

• Art n° 81200538

Perforated cubes, 0.59" x 0.59",
for tearing out



1)

Systainer³ XXL 237 + 337

Bigger, better, stronger! The Systainer³ with plenty of space and volume. The essential choice for bulky items and large materials or tools: Systainer³ XXL 237 and 337.

Systainer³ XXL 237 ¹⁾

- Light grey art n° 83000016

Systainer³ XXL 337 ²⁾

- Light grey art n° 83000017



2)

DIMENSIONS

Systainer³ XXL 237

Outside H* x W x D	Inside H x W x D	Weight	Carrying capacity	Inner volume	Pallet Pcs./H.
9.06" x 31.18" x 11.65"	7.40" x 30.96" x 10.99"	8.025 lbs	88 lbs	11.174 gal	28 / 69.57"

Systainer³ XXL 337

Outside H* x W x D	Inside H x W x D	Weight	Carrying capacity	Inner volume	Pallet Pcs./H.
12.99" x 31.18" x 11.65"	11.34" x 30.95" x 10.99"	9.546 lbs	88 lbs	16.960 gal	20 / 71.14"

*The outside dimensions are measured without feet: H +0.28"

COLORS

	Standard colors	Additional colors	
Body with lid		Additional colors upon request	
Lid handle			
Catch			
1) RAL 7035, light grey	4) RAL 9004, black	7) RAL 3002, carmine red	10) RAL 6001, emerald green
2) HKS 43 K, signal blue	5) RAL 1007, daffodil yellow	8) RAL 5015, sky blue	11) HKS 54 K, signal green
3) RAL 7016, anthracite	6) RAL 2011, deep orange	9) RAL 5003, sapphire blue	12) RAL 9016, white

LID INSERTS



Lid foam, vaulted
• Art n° 83000066

BOTTOM INSERTS



Base foam soft, 0.98"
• Art n° 83000067



Pick & pluck foam rigid, 1.97"
• Art n° 83000068



Proven
T-Loc
central controller



Interfaces
to Systainer³ M + L
and systainer³ T-Loc



Secure
the Systainer³
using an integrated
latch (Theft Tag)



Carry
the Systainer³ by using the lateral
integrated grip recess

Transport
the case using the Systainer³
CART "SYS-RB" roller board

Label
the Systainer³ with two slots
for custom labeling





Systainer³ ORGANIZER M 89

For fans of structure: Small parts sorting for professionals. With Systainer³ Organizer M 89, every small consumable material has its place and is clearly sorted. Already fitted with insert boxes or customized, it is your choice.

Systainer³ Organizer M 89

- Light grey art n° 83000010

DIMENSIONS

Outside H* x W x D	Inside H x W x D	Weight	Carrying capacity	Inner volume	Pallet Pcs./H.
3.23" x 15.59" x 11.65"	2.36" x 15.33" x 9.69"	3.527 lbs	44 lbs	1.955 gal	160 / 72.32"

*The outside dimensions are measured without feet: H +0.28"

COLORS

	Standard colors	Additional colors	
Body without lid	1) 3)	Additional colors upon request	
Catch	2)	1) 4) 5) 6) 7) 8) 9) 10) 11) 12)	
1) RAL 7035, light grey	4) RAL 9004, black	7) RAL 3002, carmine red	10) RAL 6001, emerald green
2) HKS 43 K, signal blue	5) RAL 1007, daffodil yellow	8) RAL 5015, sky blue	11) HKS 54 K, signal green
3) RAL 7016, anthracite	6) RAL 2011, deep orange	9) RAL 5003, sapphire blue	12) RAL 9016, white

Systainer³ ORGANIZER M 89 SETS



Systainer³ Organizer M 89 with 22 insert boxes

- Light grey art n° 83500001
- Insert boxes:
 - 13 pcs. 1.97" x 1.97",
 - 8 pcs. 1.97" x 3.94",
 - 1 pc. 3.94" x 5.91"



Systainer³ Organizer M 89 with 6 insert boxes

- Light grey art n° 83500002
- Insert boxes:
 - 1 pc. 1.97" x 1.97",
 - 1 pc. 1.97" x 3.94",
 - 3 pcs. 3.94" x 5.91",
 - 1 pc. 3.94" x 13.78"



Systainer³ ORGANIZER L 89

The Systainer³ Organizer L 89 for even better sorting. The case also organizes a broad range of consumable materials like screws and dowels. Everything is clearly sorted, and the transparent lid allows you to keep your perspective, even with the lid closed.

Systainer³ Organizer L 89

- Light grey art n° 83000011

DIMENSIONS

Outside H* x W x D	Inside H x W x D	Weight	Carrying capacity	Inner volume	Pallet Pcs./H.
3.23" x 20.00" x 11.65"	2.36" x 19.74" x 10.96"	4.387 lbs	44 lbs	2.562 gal	80 / 72.32"

*The outside dimensions are measured without feet: H +0.28"

COLORS

	Standard colors	Additional colors	
Body without lid	1) 3)	Additional colors upon request	
Catch	2)	1) 4) 5) 6) 7) 8) 9) 10) 11) 12)	
1) RAL 7035, light grey	4) RAL 9004, black	7) RAL 3002, carmine red	10) RAL 6001, emerald green
2) HKS 43 K, signal blue	5) RAL 1007, daffodil yellow	8) RAL 5015, sky blue	11) HKS 54 K, signal green
3) RAL 7016, anthracite	6) RAL 2011, deep orange	9) RAL 5003, sapphire blue	12) RAL 9016, white

Systainer³ ORGANIZER L 89 SETS



Systainer³ Organizer L 89 with 20 insert boxes

- Light grey art n° 83500003
- Insert boxes:
 - 10 pcs. 1.97" x 1.97",
 - 6 pcs. 1.97" x 3.94",
 - 2 pcs. 3.94" x 3.94",
 - 1 pc. 3.94" x 5.91",
 - 1 pc. 5.91" x 5.91"



Systainer³ Organizer L 89 with 10 insert boxes

- Light grey art n° 83500004
- Insert boxes:
 - 1 pc. 1.97" x 1.97",
 - 4 pcs. 1.97" x 3.94",
 - 1 pc. 3.94" x 3.94",
 - 3 pcs. 3.94" x 5.91",
 - 1 pc. 3.94" x 13.78"



1)



2)

systainer® T-LOC SYS-COMBI II + III

The perfect combination of systainer® and integrated drawer. Everything that belongs together stays together, for more tidiness in your daily routine. Available in two sizes.

systainer® T-Loc “SYS-Combi II” with drawer incl. 2 dividers ¹⁾

- Light grey art n° 81200097

systainer® T-Loc “SYS-Combi III” with drawer incl. 2 dividers ²⁾

- Light grey art n° 81200099

DIMENSIONS

systainer® T-Loc “SYS-Combi II“

Outside H* x W x D	Inside H x W x D	Weight	Pallet Pcs. / H.
10.35" x 15.59" x 11.65"	5.02" x 15.08" x 10.51"	7.05 lbs	48 / 68.11"
Drawer	2.72" x 13.78" x 10.04"	–	–

systainer® T-Loc “SYS-Combi III“

Outside H* x W x D	Inside H x W x D	Weight	Pallet Pcs. / H.
12.40" x 15.59" x 11.65"	12.40" x 15.59" x 11.65"	7.72 lbs	40 / 68.11"
Drawer	2.72" x 13.78" x 10.04"	–	–

*The outside dimensions are measured without feet: H +0.28"

COLORS

	Standard colors	Additional colors	
Body with lid			
Handle			
T-Loc catch			
1) RAL 7035, light grey	4) RAL 9004, black	7) RAL 3002, carmine red	10) RAL 6001, emerald green
2) HKS 43 K, signal blue	5) RAL 1007, daffodil yellow	8) RAL 5015, sky blue	11) HKS 54 K, signal green
3) RAL 7016, anthracite	6) RAL 2011, deep orange	9) RAL 5003, sapphire blue	12) RAL 9016, white

LID INSERTS



Lid foam, vaulted
• Art n° 81200533



Office lid
• Art n° 81200535

BOTTOM INSERTS



Base foam, soft, 0.98"
• Art n° 81200543



Pick & pluck foam, rigid, 0.98"
• Art n° 81200544

Perforated cubes, 0.59" x 0.59", for tearing out



SORTAINER T-LOC "SYS-SORT IV / 3"

The name says it all! Organize a wide range of small parts and ensure easy accessibility.

Sortainer T-Loc "SYS-Sort IV / 3"

- Light grey art n° 81200101
- With 3 drawers, each drawer with 2 dividers

DIMENSIONS

Outside H* x W x D	Inside H x W x D	Weight	Pallet Pcs. / H.
12.40" x 15.59" x 11.65"	–	13.10 lbs	40 / 68.11"
Drawer	2.72" x 13.78" x 10.04"	–	–

*The outside dimensions are measured without feet: H +0.28"

COLORS

	Standard colors	Additional colors	
Body with lid			
Handle			
T-Loc catch			
1) RAL 7035, light grey	4) RAL 9004, black	7) RAL 3002, carmine red	10) RAL 6001, emerald green
2) HKS 43 K, signal blue	5) RAL 1007, daffodil yellow	8) RAL 5015, sky blue	11) HKS 54 K, signal green
3) RAL 7016, anthracite	6) RAL 2011, deep orange	9) RAL 5003, sapphire blue	12) RAL 9016, white



1)



2)

MINI-systainer® T-LOC I

Our MINI-systainer® T-Loc I are ideal for storing small parts and fit easily inside the systainer® and MIDI-systainer®.

MINI-systainer® T-Loc I ¹⁾

- Light grey art n° 81200058

MINI-systainer® T-Loc I with transparent lid ²⁾

- Light grey art n° 81200104

DIMENSIONS

Outside H* x W x D	Inside H x W x D	Weight	Pallet Pcs. / H.
2.80" x 10.43" x 6.73"	2.09" x 10.02" x 6.08"	0.948 lbs	400 / 75.59"

*The outside dimensions are measured without feet: H +0.19"

COLORS

	Standard colors	Additional colors	
Body with lid	¹⁾ ³⁾		
Handle	¹⁾ ³⁾		
T-Loc catch	²⁾ ³⁾	¹⁾ ⁴⁾ ⁵⁾ ⁶⁾ ⁷⁾ ⁸⁾ ⁹⁾ ¹⁰⁾ ¹¹⁾ ¹²⁾	
1) RAL 7035, light grey	4) RAL 9004, black	7) RAL 3002, carmine red	10) RAL 6001, emerald green
2) HKS 43 K, signal blue	5) RAL 1007, daffodil yellow	8) RAL 5015, sky blue	11) HKS 54 K, signal green
3) RAL 7016, anthracite	6) RAL 2011, deep orange	9) RAL 5003, sapphire blue	12) RAL 9016, white

MINI-systainer® T-LOC I SETS



MINI-systainer® T-Loc I

for small bits, 3 compartments

- Light grey art n° 81200126
- With transparent lid, transparent cover and insert with 3 compartments



MINI-systainer® T-Loc I

for small bits, 6 compartments

- Light grey art n° 81200134
- With transparent lid, transparent cover and insert with 6 compartments

LID INSERTS



Lid foam, vaulted

• Art n° 81200062

BOTTOM INSERTS



Base foam, vaulted

• Art n° 81200066



Pick & pluck foam, rigid, 1.58"

• Art n° 81200070

Perforated cubes, 0.59" x 0.59"
for tearing out



MINI-systainer® T-LOC III

Our MINI-systainer® T-Loc III with its greater height offers even more volume for optimum utilization of the interior space! Of course, this model is also very easy to integrate into the systainer® and the MIDI-systainer®.

MINI-systainer® T-Loc III

- Light grey art n° 81200108

DIMENSIONS

Outside H* x W x D	Inside H x W x D	Weight	Pallet Pcs. / H.
5.59" x 10.43" x 6.73"	4.88" x 10.02" x 6.08"	1.323 lbs	192 / 77.95"

*The outside dimensions are measured without feet: H +0.19"

COLORS

	Standard colors	Additional colors	
Body with lid	1) 3)		
Handle			
T-Loc catch	2)	1) 4) 5) 6) 7) 8) 9) 10) 11) 12)	
1) RAL 7035, light grey	4) RAL 9004, black	7) RAL 3002, carmine red	10) RAL 6001, emerald green
2) HKS 43 K, signal blue	5) RAL 1007, daffodil yellow	8) RAL 5015, sky blue	11) HKS 54 K, signal green
3) RAL 7016, anthracite	6) RAL 2011, deep orange	9) RAL 5003, sapphire blue	12) RAL 9016, white

MINI-systainer® T-LOC III SETS



MINI-systainer® T-Loc III for small parts with box insert / 3-fold

- Light grey art n° 81200138
- With lid insert, EPP, 0.20" and box insert, incl. detachable colored boxes and insert with 3 compartments

LID INSERTS



Lid foam, vaulted

• Art n° 81200062

BOTTOM INSERTS



Base foam, vaulted

• Art n° 81200066



Pick & pluck foam, rigid, 1.58"

• Art n° 81200070

Perforated cubes, 0.59" x 0.59"
for tearing out



systainer® TOOL-BOX 1 + 2 **AND systainer® STORAGE-BOX**

The easily removable systainer® Tool- and Storage-Boxes are the ideal companions for flexibility and mobility everywhere.



systainer® Tool-Box 1 ¹⁾

- Light grey art n° 81200055
- 2 spacious open compartments with a low middle bar
- Individual labelling possibilities on one side

systainer® Tool-Box 2 ²⁾

- Light grey art n° 81200085
- 2 spacious open compartments with a low middle bar
- Individual labelling possibilities on one side

systainer® Storage-Box ³⁾

- Light grey art n° 81200087
- with detachable insert-boxes
(2 x small, 2 x medium, 1 x big)

DIMENSIONS

systainer® Tool-Box 1

Outside H* x W x D	Inside H x W x D	Weight	Pallet Pcs. / H.
5.63" x 15.59" x 11.65" Height with handle*: 8.19"	–	2.90 lbs	96 / 76.77"

systainer® Tool-Box 2

Outside H* x W x D	Inside H x W x D	Weight	Pallet Pcs. / H.
9.84" x 15.59" x 11.65" Height with handle*: 12.68"	–	4.40 lbs	56 / 77.95"





systainer® Storage-Box

Outside H* x W x D	Inside H x W x D	Weight	Pallet Pcs. / H.
6.30" x 15.59" x 11.65" Height with handle*: 9.17"	–	5.50 lbs	88 / 77.17"









*The outside dimensions are measured without feet: H +0.28"

COLORS

systainer® Tool-Box 1 + 2

	Standard colors	Additional colors
Body and handle	1)  3) 	
Catches	2)  	1)  4)  5)  7)  8)  9)  10)  11)  12) 

systainer® Storage-Box

	Standard colors	Additional colors
Body and handle	1)  3) 	
Catches	2)  	1)  4)  5)  7)  8)  9)  10)  11)  12) 

- 1) RAL 7035, light grey
2) HKS 43 K, signal blue
3) RAL 7016, anthracite

- 4) RAL 9004, black
5) RAL 1007, daffodil yellow
6) RAL 2011, deep orange

- 7) RAL 3002, carmine red
8) RAL 5015, sky blue
9) RAL 5003, sapphire blue

- 10) RAL 6001, emerald green
11) HKS 54 K, signal green
12) RAL 9016, white

GOOD TO KNOW

The open-top variant for the closed systainer® system.
The perfect tool box with multiple linking options.



systemer®

Additions and accessories



CUSTOMIZATION

Whether you choose outside labelling for quick recognition of the contents, or our labelling system for the inside of the systemer® – there are various easy and uncomplicated ways to customize your systemer®.

LABELING



Label set for Systemer³ Organizer insert boxes

- Large Set art n° 83500052
- Consisting of 60 paper labels and 25 transparent plug-in labels



Label set for Systemer³, systemer® T-Loc „SYS-Combi II + III“, Sortainer T-Loc „SYS-Sort IV / 3“

- Art n° 812000347
- Consisting of 20 transparent plug-in cards and 2 label sheets of 10 paper cards each

Printing, adhesive labels, or plug-in card printing on requests – we will be glad to advise you about the countless possibilities.



INCREASE YOUR MOBILITY

In our "Mobile Work" section, you will find innovative solutions to stay mobile with your systainer® system anytime, anywhere.

MOBILE WORK



Mobile Workshop MW 1000

- Black/light grey/aluminium art n° 80591031
- Incl. 1 x drawer SYS-AZ-MW 1000 and table TSB/1-MW 1000
- Dimensions: L 25.24" x W 23.62" x H 41.02"
- Work surface: 17.52" x 14.29" plus table TSB/1-MW 1000: 38.20" x 17.52"
- Working height: 35.43"
- Total load: 220 lbs
- Weight: 68.784 lbs



Systainer³ CART "SYS-RB"

- Light grey/blue art n° 83500064
- For Systainer³ M, L + XXL, Systainer³ Organizer M + L, MIDI-systainer® T-Loc II + III, systainer® T-Loc I-V, systainer® "SYS-Combi II + III", Sortainer T-Loc „SYS-Sort IV / 3", systainer® Tool-Box 1 + 2 and systainer® Storage-Box
- Even surface for the transport of various objects, four recessed grips on the sides for simple carrying, four swivel castors, two of them with brake function, big wheels (diameter: 3.94") and wheel bases for optimal running
- Mount for tie-down straps
- Dimensions: H 26.26" x W 20.00" x D 15.59"
- Carrying capacity: 220 lbs
- Net weight: 6.48 lbs

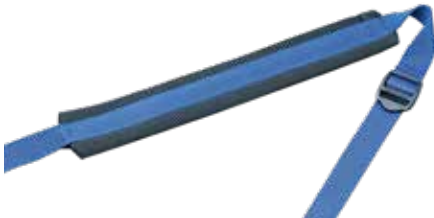

Carrying strap

- Blue/black art n° 81200154
- For the fixation on the handle
- For Systainer³ M, L + XXL, systainer® T-Loc "SYS-Combi II + III," Sortainer T-Loc "SYS-Sort IV / 3", Drawer-systainer®, Rack-systainer® IV, MAXI-systainer® II + III, systainer® Tool-Box 1 + 2 and systainer® Storage-Box
- With shoulder pad and adjustable strap



REPLACEMENT MADE EASY

All systemainer® components such as lid, handle or catches are easy to replace.

SPARES



Systainer³ catch

- For Systainer³ M, L and XXL
- Signal blue
- Art n° 83000073



Systainer³ Organizer catch

- For Systainer³ Organizer
- Signal blue
- Art n° 83000074



Systainer³ CART/BASE catch

- Signal blue
- Art n° 83000085



Systainer³ Pin

- Systainer³ M, L + XXL, Systainer³ Organizer M + L lid
- Light grey art n° 83000075



Systainer³ lid handle

- For Systainer³ M, L and XXL
- Light grey art n° 83000076



Systainer³ M lid without handle + catch

- For Systainer³ M
- Light grey art n° 83000077



Systainer³ L lid without handle + catch

- For Systainer³ L
- Light grey art n° 83000078

COLORS

	Standard colors	Additional colors
Systainer³ catch	2) 3)	1) 4) 5) 6) 7) 8) 9) 10) 11) 12)
Systainer³ Organizer catch	2) 3)	
Systainer³ CART/BASE catch	1)	
Systainer³ Pin		
Systainer³ lid handle		
Systainer³ lid M + L		

- 1) RAL 7035, light grey
2) HKS 43 K, signal blue
3) RAL 7016, anthracite

- 4) RAL 9004, black
5) RAL 1007, daffodil yellow
6) RAL 2011, deep orange

- 7) RAL 3002, carmine red
8) RAL 5015, sky blue
9) RAL 5003, sapphire blue

- 10) RAL 6001, emerald green
11) HKS 54 K, signal green
12) RAL 9016, white



SPARES



T-Loc catch

- Signal blue art n° 81200162
- For systainer® T-Loc I - V, MIDI-systainer® T-Loc II + III and systainer® T-Loc "SYS-Combi II + III"



T-Loc catch

- Signal blue art n° 81200541
- For MINI-systainer® T-Loc I + III



SYS-Sort catch

- Signal blue art n° 81200170
- For Sortainer T-Loc "SYS-Sort IV / 3"



T-Loc lid

- Light grey art n° 81200094
- For systainer® T-Loc I - V, systainer® T-Loc "SYS-Combi II + III"



Pin













































- Light grey art n° 81200166
- For systainer® T-Loc lid I - V, MIDI-systainer® T-Loc lid II + III and systainer® T-Loc "SYS-Combi II + III" lid



T-Loc handle

- Light grey art n° 81200158
- For systainer® T-Loc I - V, MIDI-systainer® T-Loc II + III, systainer® T-Loc "SYS-Combi II + III" and Sortainer T-Loc "SYS-Sort IV / 3"

COLORS

	Standard colors		Additional colors									
T-Loc catch												
SYS-Sort catch												
Catches												
T-Loc lid												
Pin												
T-Loc handle												

- 1) RAL 7035, light grey
 2) HKS 43 K, signal blue
 3) RAL 7016, anthracite

- 4) RAL 9004, black
 5) RAL 1007, daffodil yellow
 6) RAL 2011, deep orange

- 7) RAL 3002, carmine red
 8) RAL 5015, sky blue
 9) RAL 5003, sapphire blue

- 10) RAL 6001, emerald green
 11) HKS 54 K, signal green
 12) RAL 9016, white

systemainer®

Digital

ALWAYS UP TO DATE

Our website is always up to date. Never miss new product developments, system expansions or ideas to make your everyday work easier.

www.TANOSUS.com

Visit us online!



NEWSLETTER

Register for our newsletter!

Look forward to the TANOS Newsletter. You will receive fresh ideas, new products and special offers every month.

Register now at www.TANOSUS.com



SOCIAL MEDIA

You can also find TANOS on social media: receive top, current information on news, events, and product informations or share your experiences.



Facebook
TANOS systemainer®

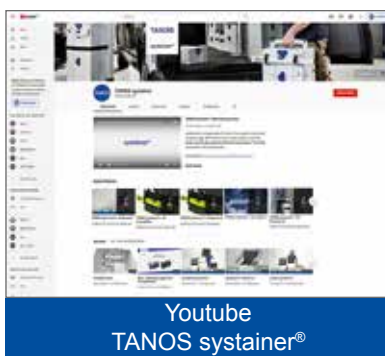

Youtube
TANOS systemainer®



Instagram
systemainer_TANOS_official

systainer® T-Loc and systainer® Classic-Line are already well-established on the market. Both generations remain part of our company. If you have any questions, please contact us. It is our pleasure to share information about these two generations of systainer®.



TANOS

Illustration in life size

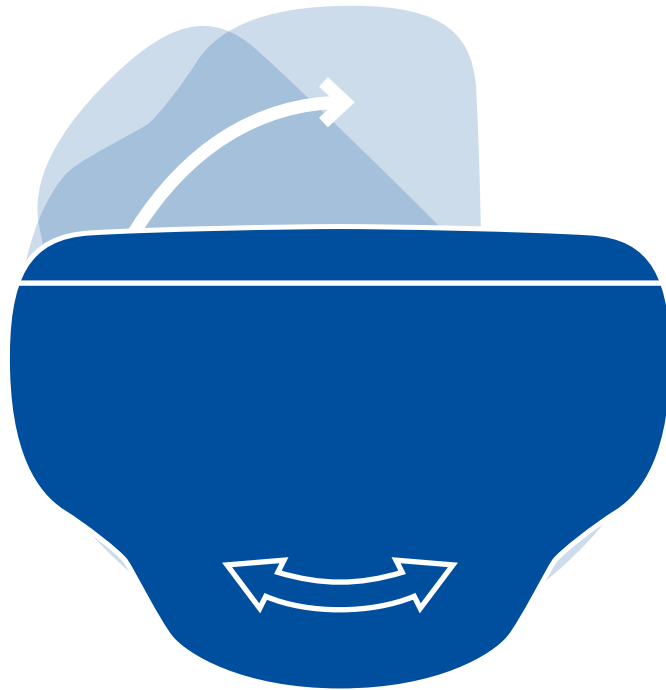

Systainer³

TANOS Inc.

4325 Beam Road, Ste. 101 D, Charlotte, NC 28217, USA
Phone (980) 938 1690
info@TANOSUS.com; www.TANOSUS.com

Issue: July 2020. We reserve the right to make product modifications, misprints and errors. Please consult the instructions before using any product. All illustrations are non-binding. Decorations and product examples not included in the scope of supply.

USA/20/06