

ROBAM



User Manual

ZQB400-S106

Steam Oven

Contents



Safety Precautions	1
Product Introduction	3
Installation Instructions	5
Operation Instructions	6
Common Faults and Fault Dropping	11
Maintenance and Care	12
Electrical Schematic Diagram	13

Safety Precautions









In order to avoid any harm or property damage to the users and other persons, following distinctions and signs are specially given.

All these are the important notices concerned with safety, so please abide by these notices strictly. And, please use this product correctly on the premise that all the contents herein are understood fully.







Distinctions on contents made in accordance with extent of harm and damage

 Danger	Personal risk, serious injury or a fire may be very likely caused if this sign is neglected and the product is operated improperly.
 Warning	Personal risk, serious injury or a fire may be caused if this sign is neglected and the product is operated improperly.
 Notice	Personal injury or damage to objects may be caused if this sign is neglected and the product is operated improperly.





Signs of the behaviors that shall be paid attention to or that shall be prohibited

 Prohibited	 No open flames	 No touch	 No remove	 Abide by strictly	 To be grounded	 Electric shock danger	 Hot surface
-----------------------------------------------------------------------------------------------	---------------------------------------------------------------------------------------------------	---------------------------------------------------------------------------------------------	----------------------------------------------------------------------------------------------	------------------------------------------------------------------------------------------------------	----------------------------------------------------------------------------------------------------	------------------------------------------------------------------------------------------------------------	--------------------------------------------------------------------------------------------------

 **Warning** Please use this product strictly in accordance with contents of this Operation Manual. Our company is not reliable for any property loss or personal injury caused by improper using of this product.

 Danger	
 Abide by strictly	When disconnecting the plug, hold the end of the plug by hand. Do not pull the power cord to disconnect the plug. Otherwise it may cause electric shock, short circuit, fire or other risks.
 Prohibited	Do not use the power socket with loose or bad contact problem. Otherwise it may cause electric shock, short circuit, fire or other risks.
 Abide by strictly	In order to avoid any potential electric shock risk, make sure the appliance is disconnected from the power supply before replacing the bulb.
 Abide by strictly	Keep the whole unit away from the heat source, gas, alcohol or other flammable materials.
 Hot surface	The appliance is hot during the operation. So not touch the heating unit in the steam oven to avoid burns. When cooking is done, oven gloves must be used to take out the food to protect from being burnt.

 Warning	
 Abide by strictly If the supply cord is damaged, it must be replaced by the manufacturer, its service agent or similarly qualified persons in order to avoid a hazard.	 To be grounded Separately use the socket of 10A or above. Do not use the same socket together with other electric appliance. Make sure the socket is securely and effectively grounded.
 Abide by strictly In case of any malfunction occurred, immediately disconnect the power supply. Do not touch the appliance and contact the professional person for repair.	 Abide by strictly Do not damage the power cord. Make sure the power cord is not bent, stretched, twisted or knotted. Do not use any weight to press on or pinch the power cord.
 Abide by strictly In order project against fire, appliance must be kept in clean condition and the air passage must be kept unobstructed.	 Abide by strictly When cooking is done, open the appliance door carefully. Hot steam will escape upon opening the door. Do not stay too close to the appliance to project against burnt by the steam.
 Abide by strictly WARNING: Accessible parts may become hot during use. Young children should be kept away.	 Abide by strictly During use the appliance becomes hot. Care should be taken to avoid touching heating elements inside the oven.
 Prohibited Do not use the rough detergent or sharp metal blade to clean the door glass of the steam oven. If the glass surface is scratched, it may cause glass broken.	 Prohibited Do not place the flammable substance (such as the smoke agent) inside or under the steam oven. When the appliance is in operation, do not spray smoke agent near the oven. Do not use appliance unattended.
 Abide by strictly Disconnect the power supply when the appliance is not in use for long time.	 Abide by strictly Improper use may result in water or gas leak. Contact the qualified service personnel for service.
 Abide by strictly WARNING: Ensure that the appliance is switched off before replacing the lamp to avoid the possibility of electric shock.	 Abide by strictly The appliance must not be installed behind a decorative door in order to avoid overheating.
 Abide by strictly Do not operate the appliance with wet hands or feet or bare feet.	 Abide by strictly The steam cleaner is not to be used for cleaning.
 Abide by strictly This appliance is intended to be used in household and similar applications such as: staff kitchen areas in shops, offices and other working environments;	
 Prohibited This appliance is not intended for use by persons (including children) with reduced physical, sensory or mental capabilities, or lack of experience and knowledge, unless they have been given supervision or instruction concerning use of the appliance by a person responsible for their safety. Children should be supervised to ensure that they do not play with the appliance.	

 Notice	
 Abide by strictly In the event of any malfunction, unplug the appliance from outlet.	 Abide by strictly During use, the steaming tray and other items should be correctly placed in the oven.
 Abide by strictly Use the special cleaner to clean the chamber and heating plate of the steam oven.	 Abide by strictly When the water in the drip tray is too excessive, adopt the absorbent cotton or cloth to absorb the water.

Product Introduction

Dear users:

We would like to extend our sincere appreciation to you for your purchase of ROBAM steam oven. We hereby recommended you to read this instruction manual carefully before installing or using the appliance. Save these instructions properly for future reference.

ROBAM is a nationwide specialized enterprise in manufacturing exhaust hood, steam oven, gas cooker, disinfection cabinet, electric oven and other household appliance & kitchen wares. ROBAM steam oven adopts the advanced design concept and attaches importance to the overall design as well as shape optimization. It is distinct with a variety of characteristics such as healthy, environmental & energy sufficiency, etc.

This appliance is accounted as class I utensil. It must be grounded when in use.

The appliance is not applicable for plateau region.

Important Information

Steam Oven Package

Please dispose these packaging materials in an environment-friendly way, in order to keep a good environment. Be sure not to allow children to play with the packaging materials (e.g. plastic film and carton box, etc.), otherwise it would lead to suffocation accident. So, please keep children away from the packaging materials.

Product Characteristics

- Glass panel with one-touch manipulation;
- Multi-function cooking mode provides more diverse steaming choices;
- Intelligent water level detection technology enables more accurate water judgment for efficient water use;
- Intelligent delay function makes cooking more convenient for users;
- Humanized chamber lighting design for checking food status from time to time;
- Electromagnetic lock, over-temperature protection and other functions make the use much safer.

Technical Parameters of the Product

Item No.	ZQB400-S106
Rated Voltage	220-240V~
Rated Frequency	50Hz
Rated Power	2100W
Capacity	40L
Working mode	High temperature steaming
Net Weight	25.5kg
Dimensions W × H × D(mm)	595 × 455 × 520

Product Structure

(The picture is for reference only, specifications are subject to the physical product)

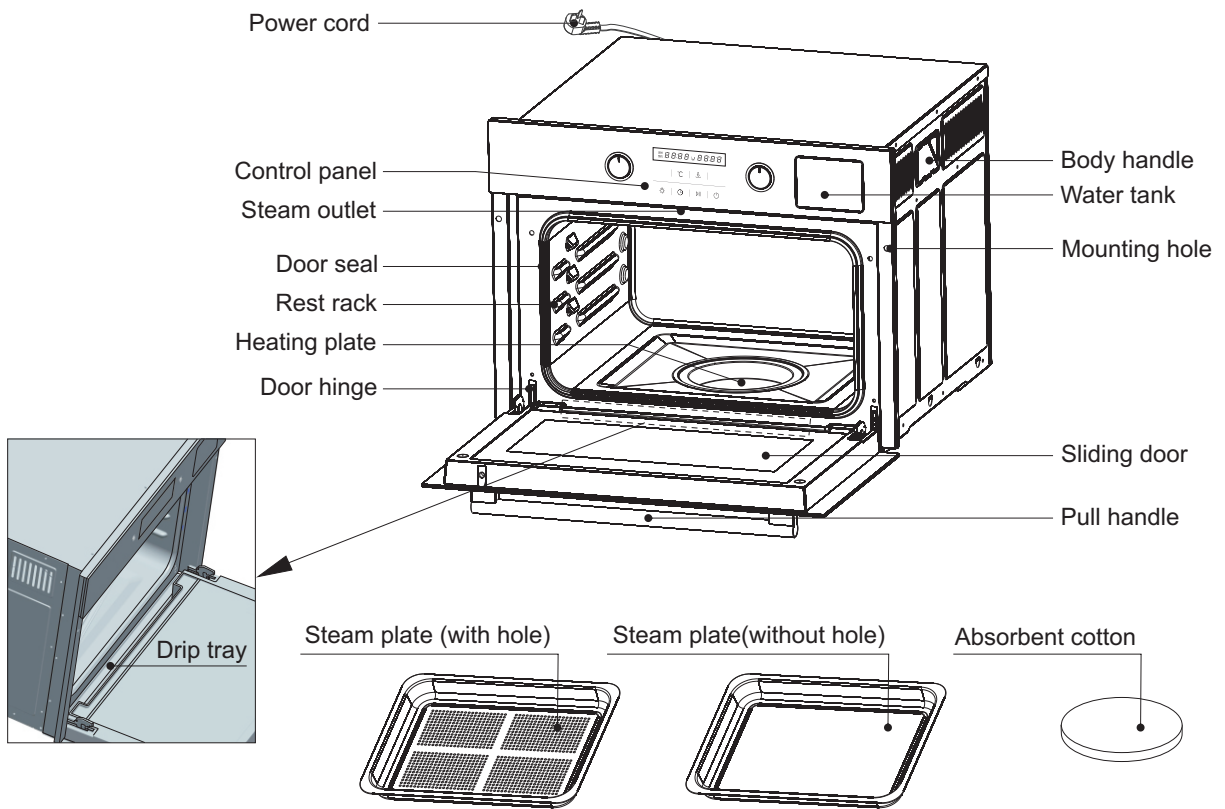

List of Accessories

S/N	Name	Quantity
1	User Manual	1 copy
2	Mounting screw	2 pieces
3	Steam plate (with hole)	1 cities
4	Steam plate (without hole)	1 cities
5	Absorbent cotton	1 cities

Installation Instructions

Follow below illustration to set the square hole at the setting position of the cabinet. Insert the steam oven steadily into the square hole in place. Do not place the oven inclined. Detailed hole size (mm), refer to the below table:

S/N	Name	A	B	C
1	Dimensions of the hole for full insertion (W×H×D)	600	460	565
2	Dimensions of the hole for semi-insertion (W×H×D)	560	450	550

(The pictures are for reference only and the specifications are subject to the physical product)

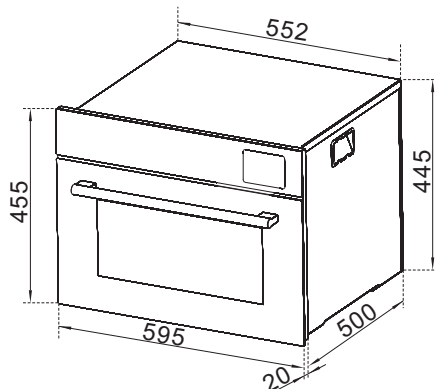

Complete dimensions diagram

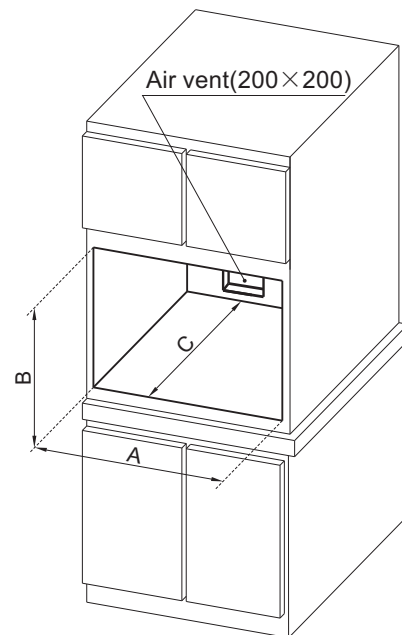

Semi-insertion hole diagram

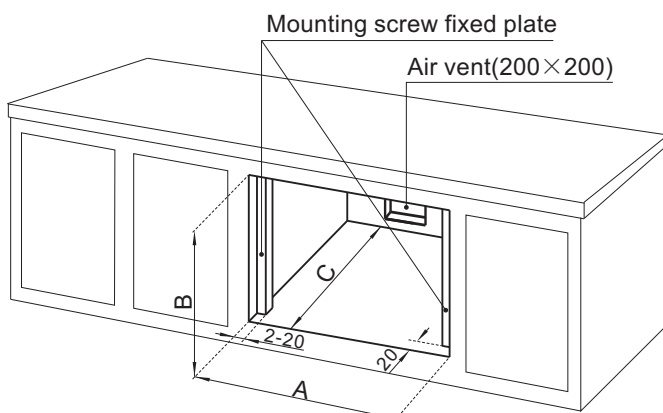

Full insertion hole diagram

Installation Requirements:

- The cabinet surface or table top to place the steam oven must be flat. The horizontal height difference between the front & back as well as the left & right must less than 8mm (approximately 1 degree).
- Make sure the air circulation as much as possible around the steam oven inside the cabinet. Recommend the clamp plate and fixing plate to adopt the moisture proof, water proof, anti-corrosion and high temperature resistant material.
- Use the two mounting screws provided to fix the unit onto the cabinet through the mounting holes on the left & right door frames.

Power Supply Requirements:

- For permanent installation, the electrical circuit must have the disconnecting and protecting device. The power connection plug and outlet should be of the same model and compliant with the local regulations.
- The power plug connection must be convenient. Make sure the steam oven can be disconnected as necessary from time to time after installation. Separately use the socket of 10A or above. Do not use the same socket together with other electric appliance. Make sure the socket is securely and effectively grounded.
- If any other electric appliance nearby, make sure the installation distance is more than 100mm.

Operation Instructions

Introduction to Control Panel

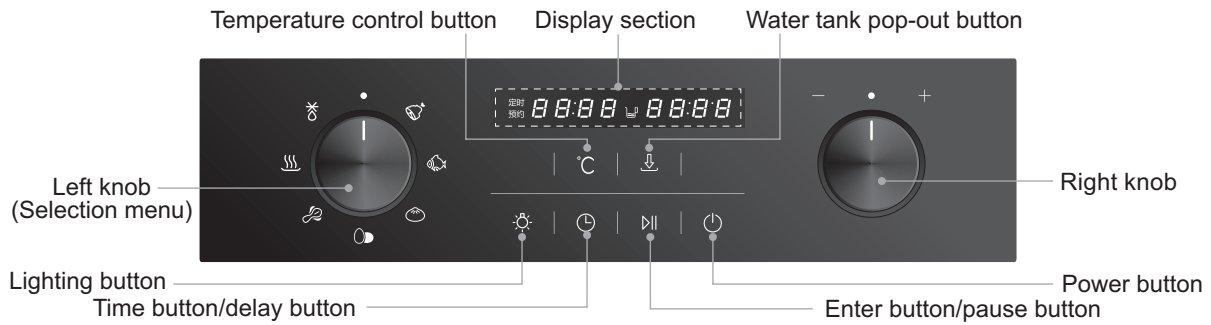

(The pictures are for reference only and the specifications are subject to the physical product)

Instructions before Use

- When using the vessel with hole to directly steam greasy food, insert the steam plate (without hole) at the first layer of the rest rack, to avoid the grease run into the chamber, resulting in difficulty for clean.

- **Cautions for installation of and filling water into the tank:**

1. When the appliance is on, press the “↓” icon to pop out the water tank. Take out the tank (see the illustration);
2. Check if the water tank is clean before use. If any abnormal odor or dirt, clean the tank accordingly. Do not use boiled water for clean;
3. Open the tank lid to fill water to the Max water level;
4. Push the tank filled with water into the tank trough.

Note: Do not fill hot water into the tank, to avoid tank deformation or damage on the appliance.

When there is lack of water, the “⚡” icon flashes and the unit beeps.

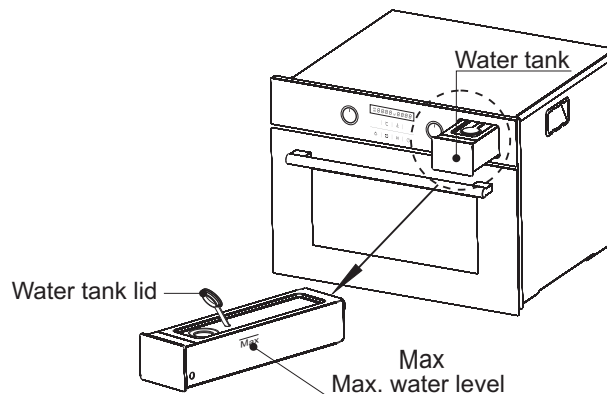

Using Methods

1. Power on

When plug in, there will be a sound and the indicator lights up. A few seconds later, the display shows 12:00, “⏻” button flashes, and all other indicators light out. The unit enters into the standby mode (as shown in the figure below).

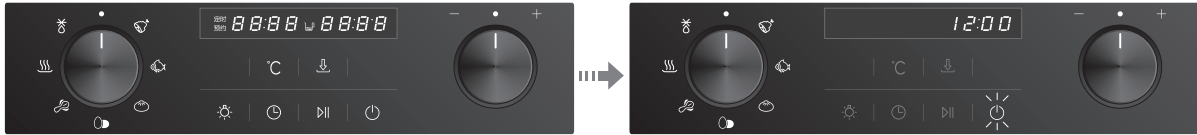

Note: If no operation after a few minutes, it switches to the off state. All indicators light out (except the “⚙️, ⏻” buttons, press any other button, “⏻” button flashes).

2. Time Adjustment

In standby code, press and hold the “⌚” button, and the hour indicator flashes. Rotate the right knob to set the hour. Then press the “⌚” button and the minute flashes. Rotate the right knob to set the minute. It automatically enters after a few seconds. Or press “⏪” button to enter the setting.



Note: The default time is 12. If the power is disconnected for a few seconds, the time will return back automatically to the default time 12:00 again. Time needs to be reset after the appliance is plugged in.

3. Starting up

Press and hold the “⏻” button to power on the unit (see below figure).

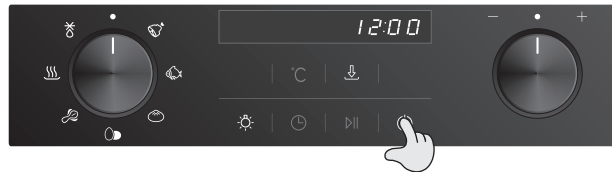

4. Select the Cooking Mode

Rotate the left knob and select the cooking mode as needed (e.g. selected the “tendon”). The default temperature and time is shown on the display (see below figure).



Set the cooking temperature. Press “°C” button and the temperature display section flashes, Then rotate the “right knob” to set the temperature needed (see below figure).



Set the cooking time. Press the “⌚” button and the time display section flashes, Then rotate the “right knob” to set the time needed (see below figure).



Note: ● If there is no need to set temperature or time, press the “▶||” button directly to start after the cooking mode is selected.

- Users may refer to the cooking reference table for temperature and time setting. Or set according to personal taste and cooking experience.

5. Confirmation to Start up

After the cooking mode is set, press the “▶||” button to start. The display panel shows the real time temperature and counting down time. When cooking finishes, the beep comes on.



■ Delay Function

For example: current time is 9am, users would like to start cooking at 10:30. Detailed operation steps are as follows:

1. Select the cooking mode first(temperature and time may be set after cooking mode is selected)
2. Press and hold “⌚” button to set the delay function and the hour setting is actuated. Rotate the “right knob” to set the hour to 10. Then press “⌚” button to actuate the minute setting. Rotate the “right knob” to set the minute to 30.
3. Press “▶||” button to start the delay function
4. When the time shown on the display panel reaches “10:30”, the unit starts the cooking mode automatically.

Note:

- Press the “⌚” button to start the delay function. Repeat pressing the button, it will switch between the hour setting → and minute setting. Operation repeats in such way;
- To cancel the delay function, press the “▶||” button or press and hold the “⌚” button.
- The delay time is the time starting the cooking.
- Before using the delay function, make sure the time shown on the unit is accurate.







■ Lighting Function

At the power connected state, press “” button to start the lighting function. Press the button again to switch off the function. Light will switch off automatically after 1 minute with no press.





■ Power off

1. Press and hold the power button at any state, the unit will be powered off.
2. At non-working state, the unit will be powered off automatically after a few minutes with no operation.
3. When the program ends, the unit will be powered off automatically after a few minutes with no operation. The fan will stop operation after delay for some time, which is helpful to extend the use life of the unit.

Mode Menu Button

Menu	Default working temperature (°C)	Default working time (min)	Temperature range (°C)	Time range (min)
 Tendon	100	60	90-100	20-90
 Fish	100	25	85-100	5-60
 Pastry	100	30	35-100	5-60
 Egg	95	20	85-100	5-60
 Vegetable	95	30	85-100	5-60
 Defrost	55	40	55-65	15-60
 Quick steam	105	60	105	20-90



Food Cooking Reference Table

Menu mode	Food	Cooking time(min)	Temperature (°C)	Comments
 Fish	Grass carp	20	100	Weighing 1000 grams approximately. Cut evenly on the back of fish
	Crucian	16	100	Weighing 300~350 grams approximately. Cut evenly on the back of fish
	Little yellow croaker	15	100	Weighing 100~200 grams approximately. Cut evenly on the back of fish
	Shrimp	10	100	Weighing 250 grams approximately
	Clam	8	100	Weighing 250 grams approximately
	Crab	15	100	4-6 crabs. Recommend to tie the crabs by a thread rope during steaming.
 Egg	Steamed egg	15	95	2 eggs, stir the egg. The ratio for egg to water is 1:1
	Egg	16	95	Whole piece
 Tendon	Pork totter	60	100	Weighing 500 grams approximately, cut into lumps
	Chick	45	100	Weighing 1300 grams approximately.
	Duck	60	100	Weighing 1200 grams approximately.
 Vegetable	Corn	30	100	Whole piece
	Potato	25	100	Weighing 250 grams approximately, cut into lumps
	Carrot	15	100	Weighing 250 grams approximately, cut into lumps
	Pumpkin	18	100	Weighing 250 grams approximately, cut into lumps
 Pastry	Steamed bread	45	100	50g/each
	Steamed stuffed bun	35	100	60g/each
	Dumpling	25	100	20-30g/each

Note: The food cooking temperature and time in the above table is for reference only. Users may set the temperature, time & menu mode according to personal taste & experience.

Common Faults and Fault Dropping

The problems listed in below table are the common malfunctions. Follow the instructions to confirm and deal with the problem. If the problem still occurs or the cause could not be determined, contact the local after-sales service department. For your personal safe, hereby reminds you: do not disassemble the unit for repair on your own.

Problem	Possible Causes	What to do
Steam oven will not start to work	Check if power is cut or the unit is correctly plugged in	Use after the power is connected
Display panel will not come up	Power is not connected or the PCB malfunctions	Check the power connection or contact the qualified personnel for repair
Light will not come on	Power is not connected or bulb failure	Check the power connection or replace the bulb
Leak gas or water during working	Door is not closed. Door seal is not installed in place or damaged	Check if the door is closed. Reinstall door seal or contact the qualified personnel for repair
Display problem 	Water tank needs more water. Tank was not pushed in place or the water level check switch fails	Add more water or contact the qualified personnel for repair
Screen becomes black suddenly during working	Upper fan malfunctions	Contact the qualified personnel for repair
Water tank is unable to pop out	Push rod motor failure	Contact the qualified personnel for repair
Display problem 	Temperature sensor inside the oven malfunction	Contact the qualified personnel for repair
Display problem 	Communication failure (Connection wire of the display panel fails)	Contact the qualified personnel for repair

Warning:

Before use, push the water tank in place. During cleaning process, do not block the inlet with foreign material. If the above problems could not be solved, contact ROBAM service center or the distributor. Disassembly by unqualified personnel is not allowed.

Maintenance and Care

Important instruction: before cleaning the steam oven, power supply must be disconnected.

Recommend to clean or maintain the unit after normal use

- Use the cloth to clean the inner container when the unit is cool and clean the door or open the door & let it dry in the air after each use.
- Take the water tank to pour out the water after each use to avoid the abnormal odor generated for some time.
- Water in the drip tray must be cleaned after use to avoid water overflow to the cabinet frame.

Recommend to clean or maintain the unit at weekly interval after normal use

- Clean inner container: use nylon brush or mild detergent to remove the dirt. Do not use the steel wool to avoid unreparable damage on the surface. Wipe with cloth after clean and keep the inner container in dry condition (Note: do not use the corrosive or abrasive detergent for clean).
- Clean the door: use the mild detergent to clean the stubborn dirt. Do not use the steel wool for clean to avoid scratch on surface. Use cloth to wipe the door after clean.
- Clean the heating plate: place the disincrustant or white vinegar into the heating plate. Use any function to heat 10-20 minutes. Switch off the function and remove the dirt water when it cools down.

Door Seal Installation Instruction

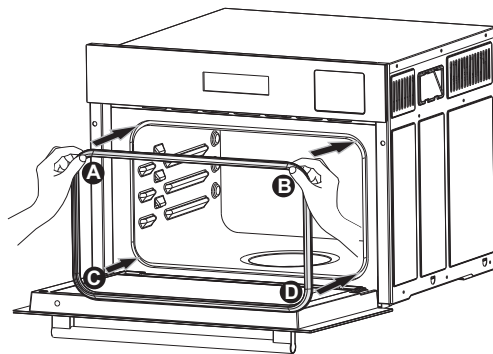

Hold the A & B half circle at the upper area of the door seal by hands. Align to the half circle slots at the upper area of the front panel and press in tightly. Then align the C & D half circles at the bottom to the two slots at the bottom of the front panel and press in tightly. Press the four sides completely into the slots. Make sure the seal is flat, not wrinkled and no gap.

Electrical Schematic Diagram

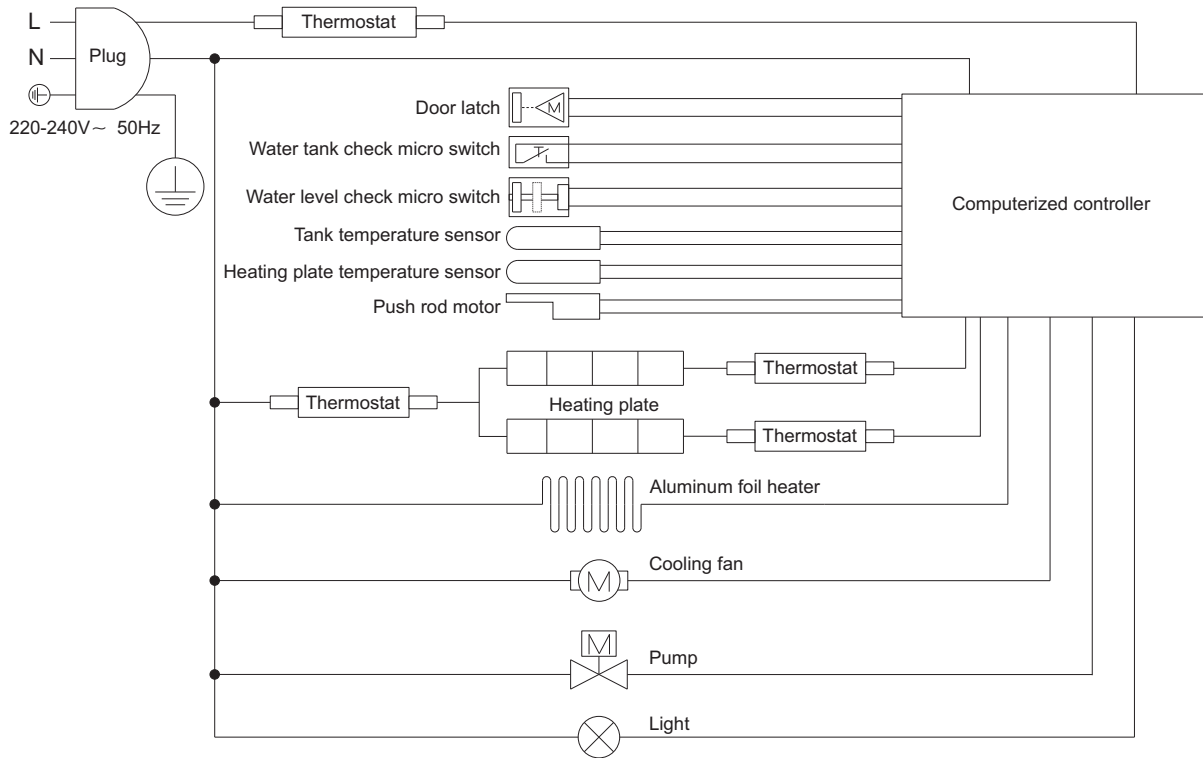

Edition: A/0
Publication Date: September,10,2017

ROBAM