

# ROBAM



## Operation Manual

**KQWS-2800-R306**

Electric Oven

# Contents



Safety Precautions .....	1
Product Introduction .....	3
Installation Instructions .....	5
Operation Instructions .....	6
Common Faults and Fault Dropping .....	11
Maintenance and care .....	11
Electrical Schematic Diagram .....	13

## Safety Precautions









In order to avoid any harm or property damage to the users and other persons, following distinctions and signs are specially given.

All these are the important notices concerned with safety, so please abide by these notices strictly. And, please use this product correctly on the premise that all the contents herein are understood fully.







Distinctions on contents made in accordance with extent of harm and damage















 Danger	Personal risk, serious injury or a fire may be very likely caused if this sign is neglected and the product is operated improperly.
 Warning	Personal risk, serious injury or a fire may be caused if this sign is neglected and the product is operated improperly.
 Notice	Personal injury or damage to objects may be caused if this sign is neglected and the product is operated improperly.







Signs of the behaviors that shall be paid attention to or that shall be prohibited

 Prohibited	 No open flames	 No touch	 No remove	 Abide by strictly	 To be grounded	 Electric shock danger	 Hot surface
--	--	--	---	---	---	---	---

 **Warning** Please use this product strictly in accordance with contents of this Operation Manual. Our company is not reliable for any property loss or personal injury caused by improper using of this product.

 <b>Danger</b>	
 <b>Abide by strictly</b> Before disconnecting plug from the socket, you should grip the end of the plug. Be sure not to disconnect the plug with power wire in your hand, otherwise such dangers as electric shock, short out and fire may be caused .	 <b>Prohibited</b> Be sure not to use a power socket which is loose or contacted poorly, otherwise such dangers as electric shock, short out and fire may be caused.
 <b>Abide by strictly</b> In order to avoid the electric shock that may occur, please ensure that the appliance has been disconnected from power before replacement of a bulb.	 <b>Abide by strictly</b> The complete appliance shall be kept far away from heat sources and inflammables (e.g. gas and alcohol).
 <b>Hot surface</b> During use the appliance becomes hot. Care should be taken to avoid touching heating elements inside the oven. when taking out foods after using, make sure to wear the high-temperature resistant protective gloves properly in order to avoid burns.	

 Notice	
 Abide by strictly If the supply cord is damaged, it must be replaced by the manufacturer, its service agent or similarly qualified persons in order to avoid a hazard.	 To be grounded Use a separate 16A or higher socket, and be sure not to connect several appliances to the same power socket at the same time, and make sure that the socket is grounded safely and effectively.
 Abide by strictly If the appliance functions improperly, make sure to disconnect it from the power and stop using immediately. And, be sure not to touch the appliance and that it is repaired by a professional.	 Abide by strictly Make sure the power cord is not damaged. When using the power cord, make sure that the cord is not bent, stretched, twisted or knotted. And, Be sure not to press or attack the power cord with weight.
 Abide by strictly You should cut off the power before cleaning of the appliance and use a neutral detergent to clean it. Moreover, make sure to clean it with a soft piece of cloth, in order to prevent its surface from being scratched.	 Abide by strictly Make sure to disconnect the electric oven from power before removing the fan guard. After cleaning, reset the guard properly to the original position in accordance with the Operation Manual.
 Abide by strictly Turn off the appliance immediately after using, otherwise the residual fat may cause a fire; in case the appliance is not to be used for an extended period of time, please cut off the power.	 Abide by strictly Hot air may come out when door of the appliance is opened after using, so please be sure not to stand too close to the appliance to avoid burns caused by the hot air.
 Abide by strictly <b>WARNING: Accessible parts may become hot during use.</b> Young children should be kept away.	 Abide by strictly <b>WARNING: Ensure that the appliance is switched off before replacing the lamp to avoid the possibility of electric shock.</b>
 Prohibited Do not use harsh abrasive cleaners or sharp metal scrapers to clean the oven door glass, since they can scratch the surface, which may result in shattering of the glass.	 Prohibited Never place any flammable substance (e.g. smoke agent) in or under the appliance; when using the appliance, be sure not to spray any smoke agent around it and that the appliance is always supervised.
 Abide by strictly In order to prevent a fire, the appliance should be kept clean and the air duct should be kept smooth.	 Abide by strictly Be sure not to operate the appliance when any of your hand or foot is wet or your feet are bare.
 Prohibited This appliance is not intended for use by persons (including children) with reduced physical, sensory or mental capabilities, or lack of experience and knowledge, unless they have been given supervision or instruction concerning use of the appliance by a person responsible for their safety. Children should be supervised to ensure that they do not play with the appliance.	

 Notice	
 Abide by strictly If the appliance functions abnormally, please disconnect the power plug and power it on again.	 Abide by strictly The internal grills and ovenware, etc. should be placed properly during using.
 Prohibited Be sure not to use a steam cleaner.	 Prohibited The appliance cannot be used as an indoor heater.
 Abide by strictly Use a temperature sensor recommended for this electric oven.	

## Product introduction

### Dear users:

We take this opportunity to express our heartfelt thanks to you for your choosing of ROBAM brand electric oven series products. We especially recommend that you shall read this Manual carefully before installing and using this product and keep it properly for later reference.

Our company is a professional corporation specializing in production of household appliances and kitchen wares such as extractor hoods, electric ovens, gas cookers and disinfecter cabinets in China. The electric oven of ROBAM brand adopts advanced design concept and optimized molding and focuses on matching with cabinet in the aspect of overall design.

### Important Information

#### Packaging of electric oven

Please dispose these packaging materials in an environment-friendly way, in order to keep a good environment.

Be sure not to allow children to play with the packaging materials (e.g. plastic film and carton box, etc.), otherwise it would lead to suffocation accident. So, please keep children away from the packaging materials.

### Product Characteristics

- Adoption of knob adjustment mode makes operation convenient;
- The high-temperature enamel liner is durable in use and the roll-over heating tube is convenient for removal and easy to be cleaned;
- Combination of special hinge and multiple layers of tempered glass door makes opening/closing of door portable and flexible;
- The multi-function baking options meet a variety of baking demands and are easy to use;
- The high-quality heating tubes for baking are characterized by rapid heating-up, high heat efficiency and long operating life;
- Adoption of energy-saving and environment-friendly high temperature-resistant super cotton brings better heat insulation performance and saves power energy during baking;

### Technical Parameters of the Product

Item No.	KQWS-2800-R306
Rated Voltage	220-240V~
Rated Frequency	50Hz
Rated Power	2800W
Capacity	56L
Net Weight	41kg
Dimensions W × H × D(mm)	595 × 595 × 520

# ROBAM | Electric Oven

## Product Structure

(The picture is for reference only, specifications are subject to the physical product)

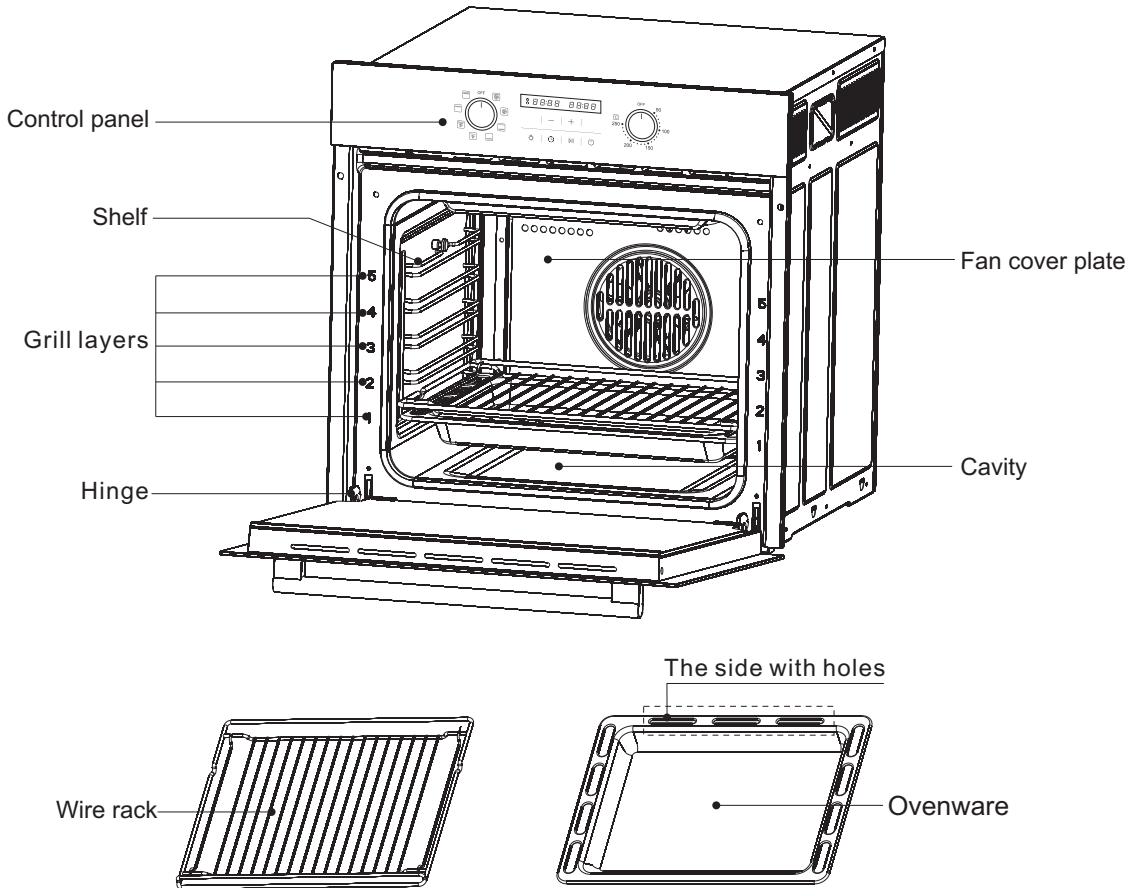

Note: when placing the ovenware, the side with holes shall be placed inward.

**The Wire rack should be placed in the Shelf.**

## List of Accessories

S/N	Name	Quantity
1	Operation Manual	1copy
2	Wire rack	1copy
3	Ovenware	1copy
4	Shelf	2copy
5	Mounting screw	2copy

## Installation Instructions

Drill a square hole on the setting position of the cabinet according to the installation drawing as shown below, insert the electric oven into this square hole stably and keep the electric oven horizontal. The specific dimensions of the hole are as shown in following table:

S/N	Name	A	B	C
1	Dimensions of the hole for full insertion	600	600	565
2	Dimensions of the hole for semi-insertion	560	590	550

(The pictures are for reference only and the specifications are subject to the physical product)

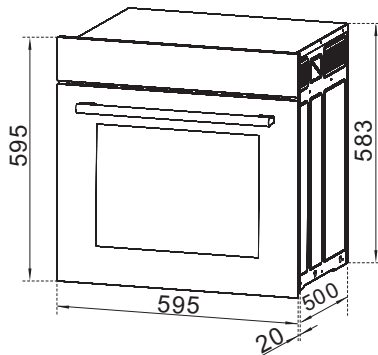

Complete dimensions diagram

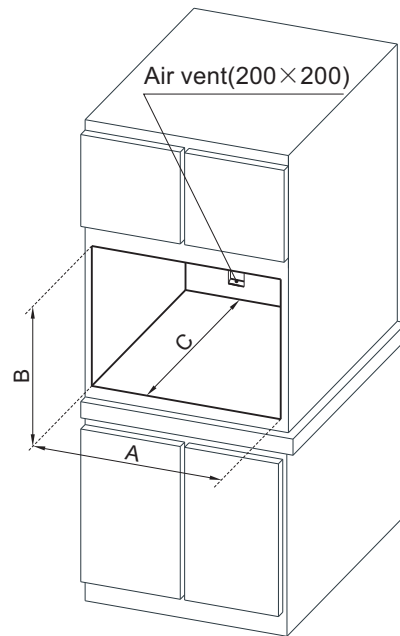

Semi-insertion hole diagram

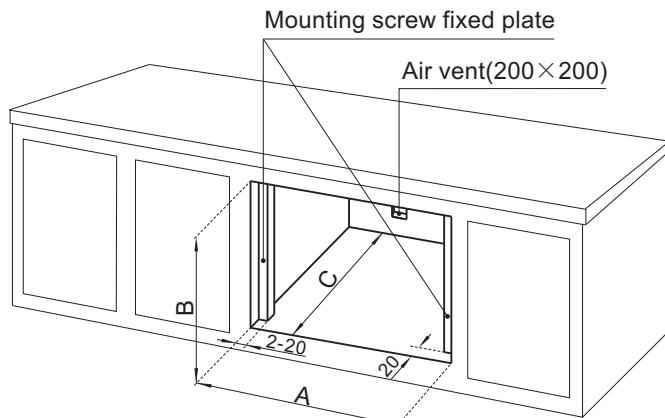

Full insertion hole diagram

### Installation Requirements:

**The oven must not be installed behind a decorative door in order to avoid overheating.**

The surface where the electric oven is to be placed on should be flat and the air around the electric oven mounted in the cabinet shall be ventilated well as much as possible. It is recommended that the clamping plates and fixed plates shall adopt incombustible thermal insulation material.

For easy connection and disconnection of power cord, be sure to disconnect the power supply at any time after the installation of the oven. a separate 16A or higher socket shall be used, be sure not to connect several appliances to the same power socket at the same time, and that the socket is grounded safely and effectively. In case there is any other electrical appliances around, please keep a 100mm or larger mounting distance.

## Operation Instructions

### Introduction to Control Panel

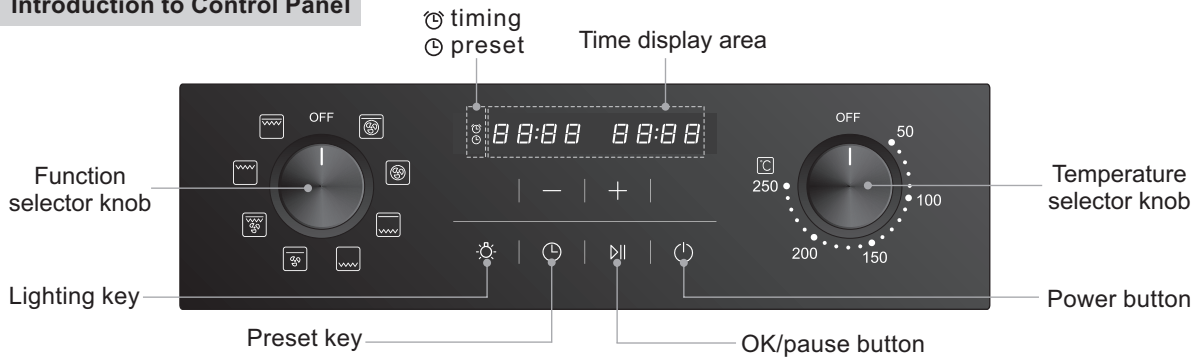

### Operation Instructions

- Since heating elements of the electric oven are protected with coating during storage, there will be a peculiar smell with evaporation of the heated coating when the electric oven is used for the first time. First of all, it is necessary to keep the room well ventilated, select the “Fan baking” function and set to the highest temperature and the longest operating duration to heat and evaporate the peculiar smell of coating without foods. Thereafter, open door of the electric oven to cool it down, in order to ensure delicacy of follow-up baking.

**Warm tips: You are recommended to open the exhaust hood when the electric oven is operating.**

### Using Methods

#### 1. Power on

A beep sounds and all indicator lights turn on when the power is turned on. A few seconds later, “12:00” will appear on the display, the “⏻” button flashes and other indicator lights turn off. And, the machine is in standby state (as shown below).

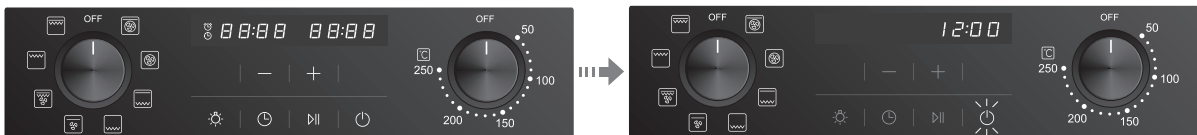

#### 2. Time adjustment

In the standby state, the “Hour” will flash when the “⌚” button is pressed and held. By this time, the “Hour” can be adjusted by pressing the “+” or “-” button; the “Minute” will flash when the “⌚” button is pressed again, and the “Minute” can be adjusted by pressing the “+” or “-” button. The result will be confirmed automatically a few seconds after the adjustment or can be confirmed by pressing the “▶||” button (as shown below).

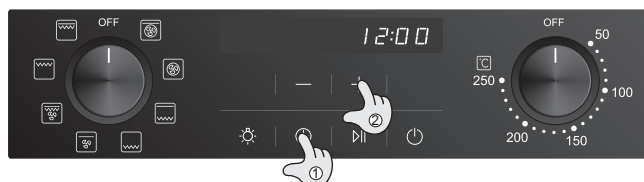

Note: the default time is 12:00. In case of a power outage, the time will reset to the default 12:00 automatically after a few seconds. And, the time shall be readjusted after power on.



### 3. Start up

Press and hold the “⏻” button to start up (as shown below);

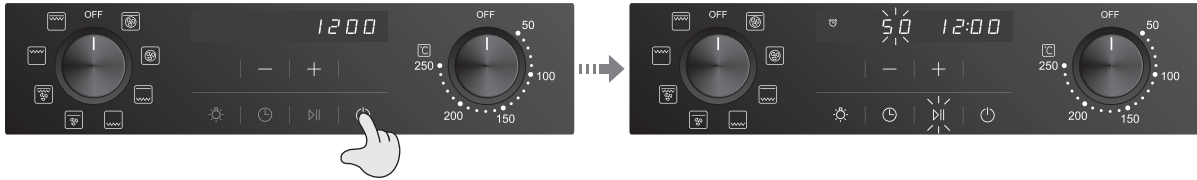

### 4. How to select functions

For example, turn the function selector knob to “🌀” icon to select the “Wind baking” function (as shown below).



Adjust time: press “+” or “-” button to adjust baking duration (within a range of 5-90min) when the time display area flashes.



Adjust temperature: turn the temperature selector knob to adjust baking temperature (as shown below).



**Note:**

- When setting the baking temperature and duration, users can adjust the temperature and duration in accordance with the baking reference table or their personal taste and cooking experiences.
- In the process of duration adjustment, the time duration will decrease or increase continuously when the “+” or “-” button is pressed and held.

### 5. Confirm to start

After the function is set properly, press the “▶||” button to start (as shown below); after baking is finished, a beep will sound.



## ■ Settings adjustment

If you want to change baking duration that has been set when the electric oven is working, please first press the “▷||” button to stop and enable the electric oven to be adjustable. By this time, you can reset the duration and press “▷||” button again after adjustment to start baking. If you want to change the baking mode or temperature that has been set, just operate the corresponding knob.

Note: The “Preset” function will be disabled after such stop.

## ■ Preset function

For example: If the time now is 9:00 a.m., the specific operation will be as follows when the client wants to preset to bake at 10:30 a.m.:

1. Select the baking mode and adjust temperature and time duration after the machine is powered on;
2. Press “⌚” button to enter into “Preset” function. By this time, the “Hour” will flash, press “+” or “-” button to adjust the “Hour” to 10; then, the “Minute” will flash when you press the “⌚” button again, just press “+” or “-” button to adjust the “Minute” to 30;
3. Press “▷||” button to start the preset function;
4. The machine will enter into baking mode when the time on the display is “10:30” .

Note: ● If you want to cancel the preset function, just press the “▷||” button.

- The preset time refers to the time that baking starts.
- Please make sure that the time of the product is correct before using the preset function.









## ■ Lighting function

The lighting function will be enabled when the “⦿” button is pressed and then the function will be disabled when such button is pressed again. And, the function will be disabled also when such button is not pressed again within one minute.

## ■ Power off

1. When the electric oven stops working, a beep will sound to hint that heating is stopped.
2. The electric oven in standby or power-on state will power off automatically several minutes after (no operation is carried out).
3. When the electric oven is working, it will stop heating and power off if you press and hold the “⏻” button.

**Baking Reference Table**









Function	Food	Position of Grill	Apparatus Adopted	Temperature (°C)	Baking Time (min)	Remarks
 Rapid heating	Corn	3	Wire rack	220-230	35-45	
	Vegetables	3	Wire rack	180-190	15-20	
	Egg tart	3	Ovenware	200-220	16-23	
 Wind baking	French chips	3	Ovenware	175-185	15-25	
	Sweet potato	3	Wire rack	220-230	45-60	About 200-300g/each
 Baking	Cup cake	3	Ovenware	170-180	20-25	
	Cake	3	Stainless steel cookware	155-165	45-55	Applicable for 8 in. cake
	Bun	3	Ovenware	165-175	15-20	About 30g/each
	Biscuit	3	Ovenware	160-170	15-22	About 3-4mm thick/piece
	Pizza	3	Ovenware	190-210	15-20	Applicable for 8in. and 9in. pizza
 Fan baking	Pork chop	3	Ovenware	190-205	18-23	About 9-12 thick/piece
	Streaky pork	3	Ovenware	210-230	25-35	The whole piece of streaky pork is 300g weight (the recommended dimensions are approximately 150x50x50mm (L x W x T))
	Bacon	3	Ovenware	195-205	7-12	About 2mm thick/piece
	Wing middle joint	3	Wire rack	180-200	15-20	About 25-35g/each
	Drumstick	3	Wire rack	195-215	20-30	About 60g/each
	Roast duck	3	Wire rack	200-220	45-60	About 1,600-1,800g/piece
	Roast chicken	3	Wire rack	200-220	35-50	About 900-1,400g/piece
	Shrimp	3	Wire rack	180-200	8-12	
	Steak	3	Wire rack	180-200	10-15	About 12-14mm thick/piece
 grill	Pork chop	3	Ovenware	200-215	20-30	About 9-12mm/piece
	Kebab	3	Wire rack	190-200	10-15	
	Sausage	3	Wire rack	190-210	15-20	
	Wing root	3	Wire rack	190-210	30-40	About 50g/each
 Strong grill	Steak	3	Ovenware	180-200	10-15	About 12-14mm/piece
	Sausage	3	Wire rack	185-195	15-20	
	Bacon	3	Ovenware	180-200	8-13	About 2mm thick/piece
	Roast chicken	3	Wire rack	195-215	50-65	About 900-1,400g/each
	Wing middle joint	3	Wire rack	180-200	15-25	About 25-35g/each
	Wing root	3	Wire rack	190-210	20-30	About 50g/each
	Drumstick	3	Wire rack	200-220	25-35	About 50g/each
	Roast fish	3	Ovenware	195-210	25-30	About 500g/piece
 Bottom heating	Crispy bun slices	3	Ovenware	160-170	10-15	About 10mm thick/piece
	Bacon	3	Ovenware	195-205	10-15	About 2mm thick/piece
 Unfreezing	You are recommended to unfreeze the foods by selecting this function.					

**Notes:**

- The baking temperature and time of foods mentioned in above table are for reference only. During baking of foods, users can adjust the baking temperature, time, baking function and baking layer according to their own tastes and baking experience;
- When baking meats of larger size (e.g. chicken and duck, etc.), the taste will be better if you have it baked at low temperature first and then bake it at high temperature thereafter;

- Before baking of foods requiring to be soured, users can have the foods soured with the prepared ingredients for approximately 30-40 minutes. Then, the foods will be tastier;
- Users also can bake the same food with different functions according to their own baking experience;
- In order to ensure that the heating is even during baking, it is recommended to turn foods over during baking. Especially, the chicken or duck should be turned over during baking.

## Baking & Heating Modes

Function	Default Time (min)	Upper Outer Heating Tubes	Upper Inner Heating Tubes	Bottom Heating Tubes	Rear Heating Tubes	Rear Fan	Lighting	Cooling Fan
 Rapid heating	50	●			●	●	○	●
 Wind baking	50				●	●	○	●
 Baking	50	●		●			○	●
 Fan baking	50	●	●			●	○	●
 Bottom heating	50			●			○	●
 grill	50		●				○	●
 Strong grill	50	●	●				○	●
 Unfreezing	50	●				●	○	●

Note: users can know the heating ways and select an appropriate baking function according to the heating modes mentioned in this table. ● Required ○ Optional

## Common Baking Symptoms and Remedies

Symptoms	Possible Causes	Remedies
Baking is uneven	<ul style="list-style-type: none"> <li>* Position of the baking layer is incorrect.</li> <li>* Foods are not placed at center part of the ovenware.</li> <li>* Selected function is improper.</li> </ul>	<ul style="list-style-type: none"> <li>* Select an appropriate baking layer position.</li> <li>* Place foods at center part of the ovenware.</li> <li>* Select a proper function.</li> </ul>
Upper surface color or bottom color of the baked foods is dark	<ul style="list-style-type: none"> <li>* Selected function is improper.</li> <li>* Size of foods is non-uniform or foods are not arranged evenly.</li> <li>* Baking temperature is too high.</li> <li>* Roast layer location is too high or too low.</li> <li>* Door of the electric oven is opened frequently during baking.</li> </ul>	<ul style="list-style-type: none"> <li>* Select a proper function.</li> <li>* Cut foods into uniform pieces and arrange them evenly on the ovenware.</li> <li>* Lower the temperature.</li> <li>* Place the foods to a lower or higher position.</li> <li>* Only open door of the electric oven when half of the baking time elapses.</li> </ul>
The baked cake has cracks or thick crust	<ul style="list-style-type: none"> <li>* The baking time is too long.</li> <li>* Baking temperature is too high.</li> <li>* Bake recipe or preparation method is incorrect.</li> <li>* Selected container is improper.</li> </ul>	<ul style="list-style-type: none"> <li>* Adjust the baking time.</li> <li>* Lower the temperature.</li> <li>* Adjust recipe and adopt correct preparation methods.</li> <li>* Replace with a proper container.</li> </ul>
The baked foods are light-colored or under-baked	<ul style="list-style-type: none"> <li>* Baking temperature is too low.</li> <li>* Baking time is too short.</li> </ul>	<ul style="list-style-type: none"> <li>* Adjust the baking temperature.</li> <li>* Extend the baking time.</li> </ul>

## Common Faults and Fault Dropping

Faults	Possible Causes	Fault Dropping
The electric oven does not work	<ul style="list-style-type: none"> <li>※The power is not connected.</li> <li>※Function button is operated improperly.</li> </ul>	<ul style="list-style-type: none"> <li>※Connect the power.</li> <li>※Operate properly.</li> </ul>
Lighting lamp of the electric oven does not turn on	<ul style="list-style-type: none"> <li>※The bulb is burnt out.</li> <li>※The bulb wire is open or disconnected.</li> </ul>	<ul style="list-style-type: none"> <li>※Replace the bulb.</li> <li>※Please contact the professional maintenance personnel.</li> </ul>
Heating of the electric oven is not enough	<ul style="list-style-type: none"> <li>※Any of the heating tube is open.</li> <li>※Any sensor fails.</li> </ul>	<ul style="list-style-type: none"> <li>※Please contact the professional maintenance personnel.</li> </ul>
Smoke is seen from the electric oven for the first time of using	<ul style="list-style-type: none"> <li>※The protective oil is volatilizing.</li> </ul>	<ul style="list-style-type: none"> <li>※Clean it out with a piece of cloth.</li> </ul>
The solid electric heating tubes fade in color	<ul style="list-style-type: none"> <li>※Fading of heating elements and ornaments when being heated is normal.</li> </ul>	<ul style="list-style-type: none"> <li>※This is normal and shall not be repaired.</li> </ul>

**Note:**

please contact with authorized service center or dealers of our company when any of the fault still lasts after fault dropping, and never allow any non-specialized person to remove or install the appliance without authorization.

## Maintenance and care

**Important Notification:** before cleaning the electric oven, make sure to cut off power of the electric oven first and never clean with steam.

Always keep the electric oven clean and make sure that no grease and oil is accumulated around the heating elements and fan; the ovenware and wire rack, etc. should be cleaned up, in order to prevent a fire from being caused by accumulated grease; before baking of meats, wrap the meats with a piece of aluminum foil in order to make it convenient for later cleaning; all the greases and oils will form a layer of lacquer deposit which is difficult to be cleaned in the electric oven. Therefore, the electric oven shall be cleaned thoroughly after every use.

1. Cavity of electric oven: clean it with warm water without using any corrosive or abrasive detergent; the stains which are difficult to be removed can be cleaned with a nylon brush or mild detergent rather than a steel wire ball, in order to avoid the surface from being left with un-repairable damages. The detergent to be used in the cavity should be cleaned up and no residue shall be left. After cleaning, wipe cavity out with a piece of wet cloth and keep it dry.

2. Glass panel: the glass panel of door and control panel shall be cleaned up immediately after it becomes dirty. The dirt that is difficult to be removed shall be cleaned with mild detergent rather than a steel wire ball, in order to avoid the surface from being scratched. After cleaning, dry it with a piece of cloth.

3. Removal and installation of fan cover plate: the fan cover plate is fixed to the internal cavity with 4 bolts and can be removed by screwing these bolts anticlockwise. Note: the fan cover plate should be reinstalled after being cleaned.

4. Removal and installation of lighting lamp in electric oven: remove the lighting lamp of the electric oven by rotating the glass lamp cover anticlockwise and then pull out the bulb; inset the bulb upward and rotate the glass lamp cover clockwise so that the lighting lamp of the electric oven is reinstalled.

5. In order to make it convenient for cleaning the top of the cavity, you can flip the upper heating tube down. First, rotate the fixation column of heating tube for 90 degrees (as shown in Fig.1), at this moment, the fixed plate at front end of heating tube will separate from the fixation column and then the heating tube can be flipped down about 20 degrees (as shown in Fig.2). Then retighten the upper heating tube in opposite direction, and reinstall the fixed plate of upper heating tube to the fixation column, then rotate it for 90 degrees.

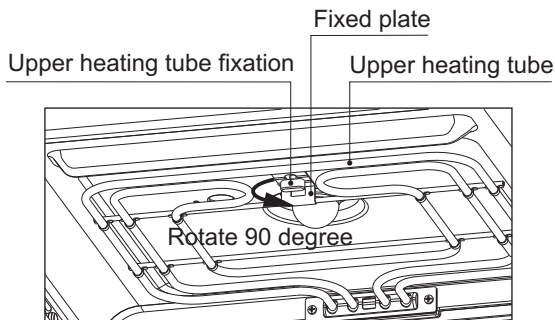

Diag. 1

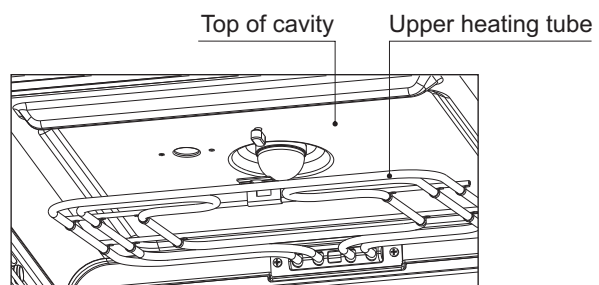

Diag. 2

6. Removal and installation of shelves (the procedures for left shelf are the same with that of the right one): press the position of shelf 1 (as shown in Diag.3) until the shelf is disconnected from the positioning bolts, then tilt it to a certain angle and take it out along the direction of arrow as shown in Diag.4, then the shelf can be removed. When reinstalling the shelf, align lower end of the shelf with hole 1 and 2 as shown in Diag.4 and insert the shelf into the hole, then secure the upper end of the shelf with positioning bolts.

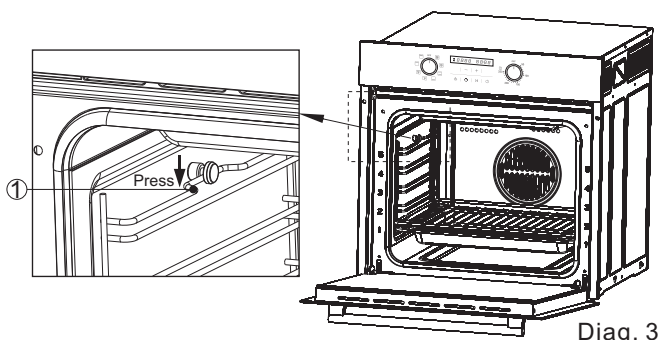

Diag. 3

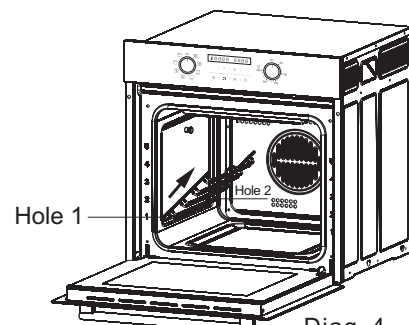

Diag. 4

Note: please adjust the angle slightly during installation or removal, or the liner enamel would be damaged.

## Electrical Schematic Diagram

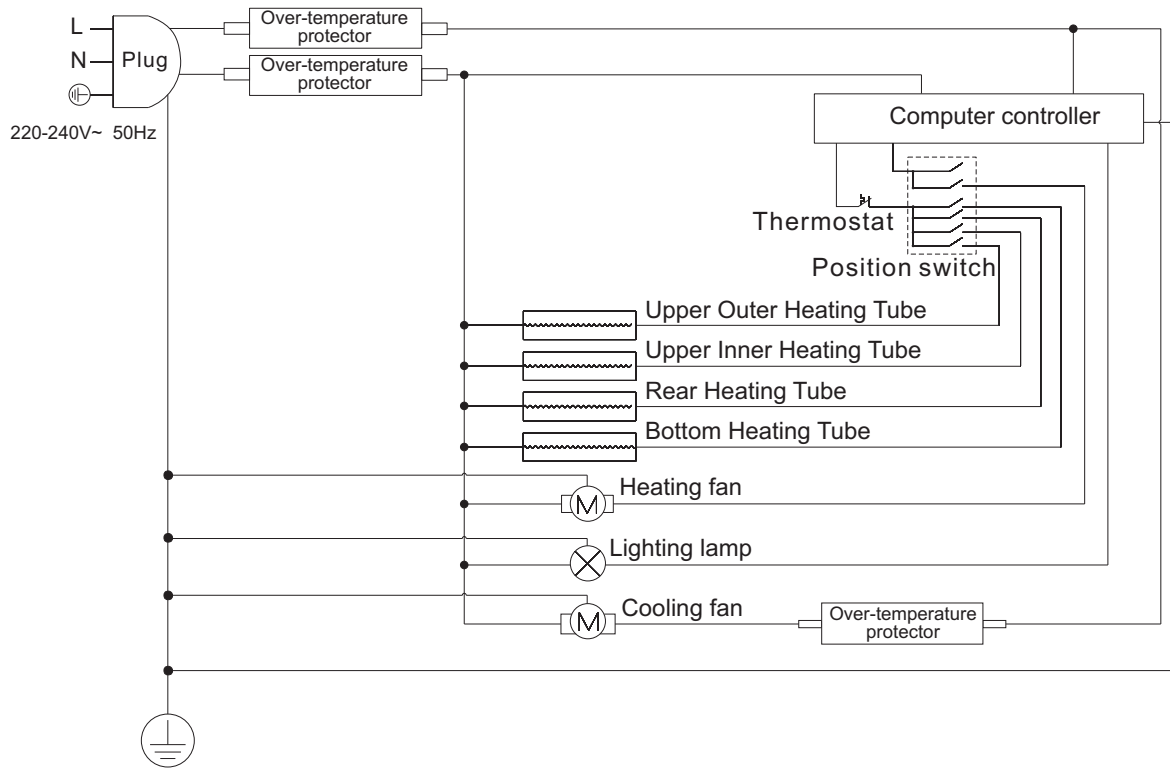

### Special statements

Technical improvements of the product (if any) will be incorporated in the Operation Manual of a new version without notice. If any alteration occurs on appearance or color of the product, the actual specifications are subject to the physical product.

Edition: A/0  
Publication Date: April,01,2017

**ROBAM**