

ROBAM



User Manual

Before operating this unit, please read the user manual completely and keep it.

CXW-220-A670

Range Hood

CONTENTS

Safety Precaution.....	1
Important Information.....	3
Product Overview.....	4
Packing List.....	4
Installation Instructions.....	5
User Manual.....	8
Maintenance.....	10
Removal of Components.....	10
Circuit Diagram.....	12
Troubleshooting of General faults.....	13

Dear users:



Thank for your buying our range hood. Please accept our best regards. Please read this user manual carefully before installation and operation.

*The pictures in this manual only for your reference. If the picture isn't accord with object, subject to object. We keep to right to update appearance, structure or products without notice.

Safety Precaution

In order to avoid harm or property damage to the users or other person, the following distinction and marks are stipulated. They are important safety precaution, please comply strictly based on the full understanding.









Subject to harmful or destruct degree

 Danger	If ignore this sign and operate product improperly, it's highly possible to cause danger, serious injury or fire.
 Warning	If ignore this sign and operate product improperly, it's possible to cause danger, serious injury or fire.
 Notice	If ignore this sign and operate product improperly, it's possible to cause injury or loss.

Notice and Prohibit Mark

 Prohibit	 Prohibit Flame	 Prohibit Touch	 Prohibit Touch by Wet Hand	 Prohibit Disassembly	 Strict Execution	 Necessary Earthed	 Caution Electric Shock	 Caution Scald
---	--	--	--	--	--	--	--	---

 Warning Please use this product according to manual strictly, or ROBAM shall not take any responsible caused by improper operation.







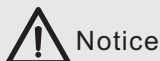

 Danger	
 Prohibit Don't allow children or weakling to use range hood separately, or it may cause electric shock or other accident.	 Prohibit Touch by Wet Hand Don't touch plug, electric parts or button by wet hands, or it may cause electric shock.
 Prohibit Prohibit water on motor, switches or other electric parts; Prohibit wash range hood by water spray. Don't use range hood if wet or it may cause electric leakage or shock.	 Prohibit Don't change, stretch, bind or press electric wire, or it's possible to cause electric shock or fire because of broken wire.
 Strict Execution The electric wire must be cut off before clean, install or maintain range hood avoiding from electric shock.	 Prohibit Prohibit any change of interior circuit, or it may cause injury or other danger, for example, electric shock or fire.
 Strict Execution Please turn off range hood immediately if pan got fire (range hood shall aggravate fire if it's working) and extinguish fire by effective action. For example, cover flame by metal cover, turn off gas valve immediately and remove inflammable things.	 Strict Execution Any abnormal, please turn off power, take off plug or cut off electric source, and contact service. It's possible to cause electric shock or fire if using range hood under abnormal situation.

Warning

 <p>Range hood must be installed, disassembled or maintained by professional person.</p> <p>Prohibit Disassembly</p>	 <p>Put out the stove fire in time when it is not used. That the stove fire bakes the range hood directly is prohibited. Do not barbecue food directly under the range hood lest the range hood is damaged and an accident should occur.</p> <p>Prohibit</p>
 <p>In order to ensure safety, range hood must be installed by specific accessory (especially expansion pipe and wooden screws, or it may cause accidental drop of range hood). The pipe bore and hole must fit tightly during the installation of metal expansion pipe. It is prohibited to make excessively large hole to prevent accidental drop of loosening expansion pipe.</p> <p>Strict Execution</p>	 <p>The range hood must be used by specific plug and properly ground it. It's possible to cause electric shock, hot plug or fire because of improper electric wire. Installation must be executed by professional person based on local electrical regulations. Before connect electricity, power must be turned off.</p> <p>Strict Execution</p>
 <p>If electrical wire is broken, only professional engineer can replace it.</p> <p>Strict Execution</p>	 <p>All operation must comply with our safety guidelines as well as local safety regulations.</p> <p>Strict Execution</p>
 <p>If the range hood will be used with the kitchen range burning gas or other fuels, the room must be well ventilated.</p> <p>Strict Execution</p>	 <p>The range hood is used only daily life not special environment (for example, outside). And it's not allowed to exhaust dangerous or explosive matter or air. It should be put under dry and ventilation environment without dangerous air.</p> <p>Strict Execution</p>
 <p>The range hood and electric circuit must be installed by skilled and trained personnel with required qualification. When installation, the related regulation, standard or instruction on fire must be complied. It may cause danger because of improper installation, for example, electric shock, drop or fire accident.</p> <p>Strict Execution</p>	 <p>The outlet must be connect with outside. In order to ensure safety and fresh air, waste gas should be exhaust to outside. Don't exhaust waste gas to the wall, loft or garage.</p> <p>Strict Execution</p>
 <p>It may get fire if cleaning range hood not in accordance with manual.</p> <p>Strict Execution</p>	 <p>Don't touch bulb if it's on or just close in short time, or it may cause scald.</p> <p>Prohibit Touch</p>
 <p>Keep a good habit to turn off gas hob and gas valve if go outside, sleep or finish operation. Replace or check gas pipe regularly, since gas alarm device can't completely avoid accident caused by gas leakage.</p> <p>Strict Execution</p>	



Notice

 Prohibit The gas from range hood shall not be exhausted to hot flue used for burning gas or other fuels.	 Strict Execution The temperature for range hood working can't exceed 40°C.
 Strict Execution Because the installation is difficult and hood is heavy, the installation shall be executed by professional person based on manual.	 Strict Execution Before removing range hood for installation, clean or maintenance, power must be cut off avoiding from electric shock. When installation, clean or maintenance, protective glove must be wear avoiding from injury.
 Strict Execution Don't break electric wire or other invisible equipment when cutting something or drilling holes on ceiling.	 Strict Execution When range hood is using in well sealed building, it should have air inlet or open door to ensure good ventilation.
 Strict Execution When the oil exceeds 2/3 or near tick mark in the oil cup, clean it in time. Don't eat waste oil from oil cup.	 Strict Execution The wall of installing range hood needs enough strength. For hollow walls, the thickness of solid layer of hollow wall must be more than 30mm, but for concrete walls, it can be drill holes directly. The range hood must be fixed on the wall firmly.

Important Information

Package of Range Hood

Please settle those packages carefully in order to protect environment.

Don't allow children to play plastic film and package, it may cause asphyxia. Please avoid children near package material.

Before use Range hood

This range hood exhaust fume outside.

Please read this manual and all information carefully before installation and operation. Please comply with our suggestion. If it's necessary, please read manual for gas hob. And please keep these manual carefully for future reference.

If range hood has obvious damage, please don't electrify and contact operator.

This appliance is not intended for use by persons (including children) with reduced physical, sensory or mental capabilities, or lack of experience and knowledge, unless they have been given supervision or instruction concerning use of the appliance by a person responsible for their safety.

Children should be supervised to ensure that they do not play with the appliance.

Product Overview

Technical Specification

Model	CXW-220-A670	Noise	57dB
Power Supply	220-240V~ 50Hz	Rated Input Power of the Hood	222W
Total Pressure Efficiency	≥23%	Rated Input Power of the Main Motor	220W
Nominal Pressure	340Pa	Maximum Input Power of the Light	≤2W
Air Flow Rate	19m ³ /min	Dimensions (L×W×H)	895 × 399 × 548(mm)
Maximum Static Pressure	430Pa	Net Weight of the Host	27.5kg
Odour Decrease Rate (Normal)	≥98%	Grease Separation Rate	≥92%
Odour Decrease Rate (Instantaneous)	≥80%		

Note: 1. The deviation between the expressed value and measured value of air flow rate, maximum static pressure and nominal wind pressure shall not exceed -10% of the expressed value.

2. When stir-frying function is enabled, the power will increase by 10% compared to strong power (level-2), and the air flow rate is 20m³/min.

Body Size



The marked sizes are for reference only. (Unit: mm)

Packing List

Please check lists if open the package.

Packing List	No.	Name	Quantity	No.	Name	Quantity
	1	Range hood	1 piece	8	Check valve	1 set
	2	Φ185 (OD) aluminum exhaust pipe	1 set	9	ST4x18 self-tapping screw	10 piece
	3	Exhaust pipe connection		10	ST4×60 wooden screw	4 pieces
	4	Exhaust pipe fixed strip		11	Hitching foot stopper	1 piece
	5	Exhaust pipe tape		12	M6 metal expansion pipe	1 pair
	6	Plastic expansion pipe	4 pieces	13	Hitching foot	1 piece
	7	User manual	1 piece	14	Oil cup	1 piece

Installation

Warning

1. The air must not be discharged into a flue that is used for exhausting fumes from appliances burning gas or other fuels, the discharge of air must fulfill the requirements of local regulations.
2. Note that when installing the metal expansion pipe, the pipe shall match with the hole in size. Overlarge hole is prohibited, as it will result in loose pipe and accidental drops.
3. There shall be adequate ventilation of the room when the range hood is used at the same time as appliances burning gas or other fuels.
4. If the flue aperture is less than air duct aperture, it will influence the fume suction effect and the too long air duct will influence the fume suction effect, too.
5. This product is only for daily use and please do not use it under special environment (e.g. outdoor); nor can it be used to exhaust hazardous or explosive substance or gas. Before assembly, the product shall be placed in environment which is dry, ventilated without corrosive and harmful gas in the surrounding.

Preparation for installation

● Surrounding

Keep the hood away from too many doors and windows, so as to avoid air convection affecting the efficiency.

● Tools preparation

The hood will be installed with the following tools: 1. an impact drill (with drill bit) 2. a wrench 3. a screwdriver; and 4. a ruler.

Notice

- Installation and circuit setting must be done by experienced professionals. Only a professionally trained person with an installation qualification can install the hood. Non-professionals are not allowed to install, dismantle and repair the hood.
- Please do not power on the hood before installation to avoid electric shock.
- Do not expose the hood if your kitchen is under renovation, because construction materials, dusts, paint, coatings, and emitted gases will corrode and tarnish the hood surface. Therefore, it is recommended to install it after the renovation is completed.
- Don't install the hood on wood and other combustible walls. The wall shall be made of noncombustible materials with enough strength and the surface shall be flat.
- The hood may have very sharp edges. So, please wear protective gloves during hood installation, cleaning or repair.
- When drilling on the wall or ceiling board, keep away from embedded wires and other concealed devices to avoid electric shock and fire.
- Do not install the hood at a too high position as well as keep the hood free from disturbance of ambient airflow lest the reduction of smoke pumping effect shall occur.
- When making cabinet, please leave space for installation and disassembly of the hood in order to maintain and overhaul the hood.
- When installing, please keep the machine body remain horizontal.
- Please use single phase grounded socket and the hood shall be well grounded (water pipe grounding is not reliable and gas pipeline grounding has risks of causing fire disaster and explosion).
- In order to ensure safety and successful installation, please use standard accessories provided with the hood for installation, otherwise the hood may be at risk of falling down.
- If the power cord is damaged, in order to avoid danger, it must be replaced by manufacturer, professionals of its maintenance department or similar departments. Please do not carry out restructuring, stretching, knotting and squeezing or apply heavy objects to the power cord, etc., otherwise it may cause power cord damage easily, leading to accidents such as electric shock and fire disaster, etc.
- After installation, please clean the surface of the hood, and then supply power for test run.

Installation

Note: All data units in the following figures are in mm

Figure 1

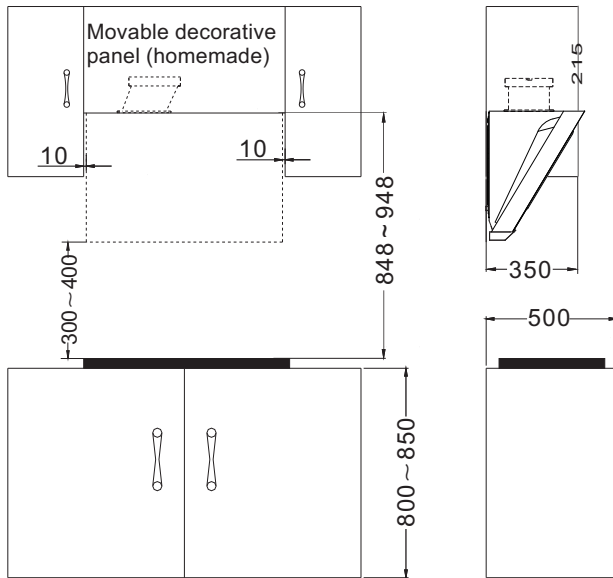

Cabinet dimension is for reference only

Figure 3

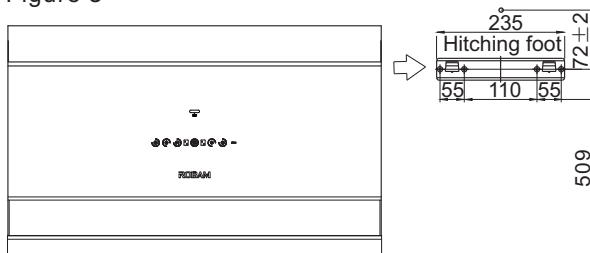

Hole size of the exhaust pipe $\Phi 200\text{mm}$

Figure 2

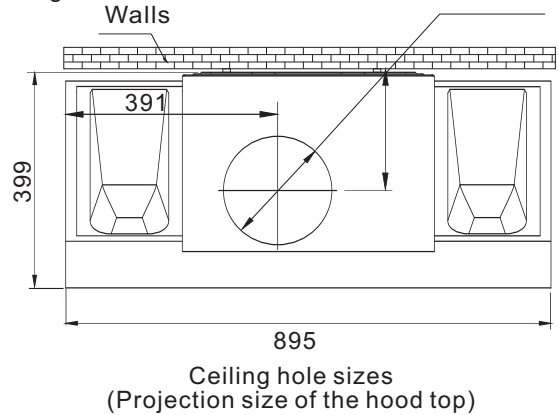

- 1. Determine the position:** Preliminary dimensions of cabinet is shown as Figure 1, ceiling hole size is shown in .

Hitching foot stopper

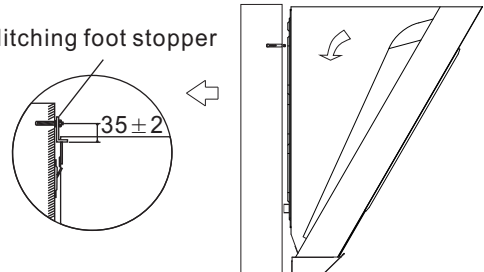

2. Install hitching foot: according to the size of the hitching foot, drill four 60-70mm-deep holes on the wall accordingly with an 10mm-diameter drill bit (overlarge holes are prohibited). Press the expansion pipe into the holes, and then reliably fix the hitching foot with 4 accompanying ST4×60 wood screws. Drill a hole with diameter of 10mm and depth of 50-55mm at the position 72mm above the four holes and insert the M6 metal expansion pipe into the hole. (As shown in Figure 3)

3. Install the hood body: fix the check valve as shown in Figure 5. Then direct the hanging holes in the back of hood at the hooks of hitching foot according to Figure 3, and press them together. Shake the body to check if it's hung securely. After the body is mounted, install the hitching foot stopper and gaskets to the M6 metal expansion pipe, and then tighten the nuts (to prevent accidental decoupling of the body under external force).

Install the aluminum foil exhaust pipe

●Drilling position of the aluminum foil exhaust pipe (public flues do not require drilling)

- Aluminum foil exhaust pipe and hob facing the window: Remove one of the glasses and install a plywood with ventilation holes or punch directly on the glass.
- Hob away from the window: Install the aluminum foil exhaust pipe through the window that is close to the hob and connected outside; or install it by punching on the wall that is close to the hob and connected outside.

c. Drill hole through the wall: Determine the location of the aluminum foil exhaust pipe against the wall and draw the drilling range (i.e. a circle slightly larger than the pipe OD). Then use a long drill bit to drill through the wall. Pay attention to the wall structure and material, so as not to destroy other parts of the wall.

● Link the aluminum foil exhaust pipe

Insert the end of aluminum foil exhaust pipe without fixed strip to the pipe connection and stick with tapes, then straighten the aluminum foil exhaust pipe and connect it to the public flue outlet (If there is no public flue, please straighten the aluminum foil exhaust pipe to the outdoors). This can be done directly when the public flue outlet or wall hole is larger than the aluminum foil exhaust pipe. Otherwise, there are five types of pipe small ends (OD: 140, 150, 160, 170 and 180 respectively) to be chosen from according to the hole size. Then cut the excess part smaller than public flue outlet or wall hole with scissors.

Then insert the end of the aluminum foil exhaust pipe with fixed strip in the outer ring of the check valve connection and seal with exhaust pipe tapes. At last, put four snaps of the check valve connection in corresponding slots, and rotate them clockwise to fix the exhaust pipe to the check valve.

Figure 4

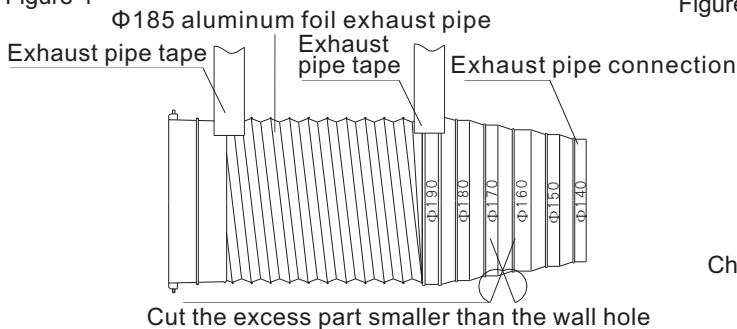
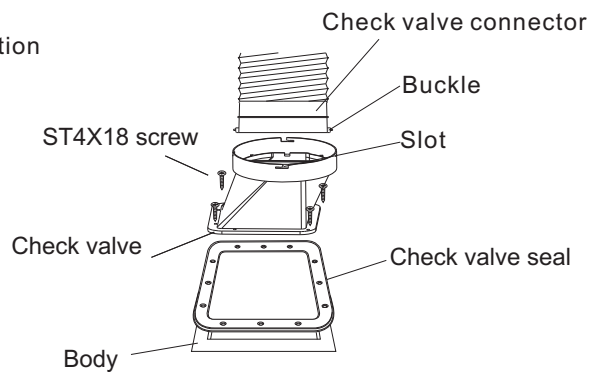

Figure 5



Note: During installation, straighten the aluminum foil exhaust pipe to avoid noises in semi-stretched state. Excess part may be cut with a wire cutter.

The exhaust wall hole diameter shall be close to that of the exhaust pipe, which shall not be too small. Otherwise, it will cause poor exhaust efficiency, more noises and lower airflow, etc. The connection between the pipe and the hole or the public flue must be sealed tightly to ensure that, the pipe and the check valve or public flue are connected securely. The blades at the check valve connection or public flue connection must be flexible.

User Manual

Switch Control Panel

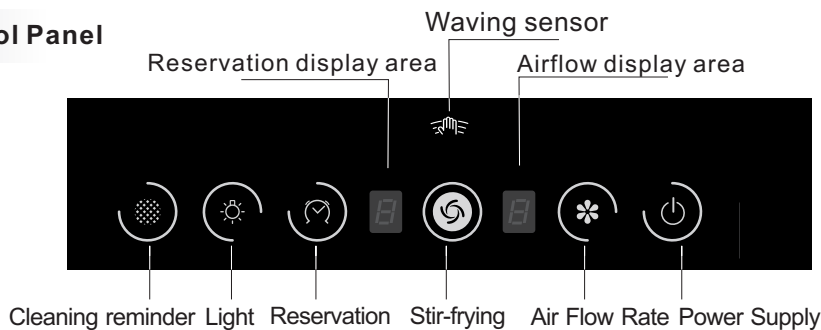

Power Supply

When the hood is shutdown, press the power button to enter standby mode, and now the fan is enabled. If the fan is working, after pressing the power button, the power icon will flash and the fan will be shut down after 1 minute. When the power button is flashing, press the button again, all functions will be disabled.



Air Flow Rate

In the standby status, press the airflow button, the smoke deflector will be unfolded, and the fan will run at “Level-2”; then repressing the airflow button, the fan will run at “Level-1”, and then press again to shut down the fan.



Light

Press the light button to turn on the light and repress to turn it off. (Press the light button in off mode, the smoke deflector and the light will be turned on at the same time.)



Stir-frying

In the standby status, press the stir-frying button, and the smoke deflector will be unfolded, and the fan will run at “Level-6”; then repressing the stir-frying button to shut down the fan. After running at “Level-6” for 3 minutes, the hood will automatically switch to “Level-2” airflow. In off mode, keeping pressing the stir-frying button for 3 seconds can check the accumulative total running hours of the hood.



Reservation

Press the reservation button when the fan is working, each press will increase the reservation time by 10 minutes, and the maximum reservation is 60 minutes. Upon end of reservation, the hood will sound a beep. Now, press any button to cancel the beep.



Cleaning reminder

After the hood has run for 60 hours, the “cleaning reminder” icon will flash to remind the user to clean the oil filter. Now press the cleaning button to enter cleaning mode (when the fan stops, in addition to cleaning button and light button, the rest buttons are invalid), in which users can clean the oil filter by themselves. Keep pressing the cleaning button for 3 seconds to exit the cleaning mode after cleaning, and the cumulative time will be cleared. In normal state, keeping pressing the cleaning button for 3 seconds can enter cleaning mode.



Waving sensor

In off mode, the waving sensor is on standby. In standby mode or fan operation mode, the “Level-6” can turned on or turned off by the waving sensor. In the off mode, keep pressing the “stir-frying” button and “airflow” button for 3 seconds at the same time can turn on or turn off the waving sensor.

Maintenance

⚠ Warning

1. There is a fire risk if cleaning is not carried out in accordance with the instructions.
2. Cleaning and maintenance shall be conducted under outage. Electrical components such as motor, switch, and connector shall not be spoiled by water so as to prevent from accidents.
3. It's prohibited to wash with water so as to prevent accidents.
4. Stove fire shall be extinguished timely when it is not used; do not flambe under the range hood and it's prohibited to bake food under range hood directly to prevent range hood from damaging and causing accidents.
5. If the supply cord is damaged, it must be replaced by the manufacturer, its service agent or similarly qualified persons in order to avoid a hazard.
6. Accessible parts may become hot when used with cooking appliances.

Notice

●The hood shall be cleaned and maintained regularly depending on the surroundings, so as to keep its cleanness & efficiency and extend its service life.

We recommend that:

Clean the exhaust fume collecting hood and hood body after each cooking.

To ensure smooth discharge of fumes, the filter screen shall be cleaned regularly according to actual situations. Be careful to avoid damage when cleaning.

●It is recommended to use a neutral detergent to clean instead of strong detergents, and dry with a soft cloth, and should avoid the contact between detergent and control buttons.

●Do not allow stains to stay on the surface of the hood for too long.

●Please do not use cleaning balls, brushes and other rough objects to clean the hood to prevent the body surface from scratching.

●When cleaning or maintaining the hood, please wear protective gloves to prevent wounding during wiping.

●Please check and clean the oil cup regularly. Pinch the oil cup by hands as the right picture and pull out to pour the waste oil.

●Do not touch the light bulb that has been turned on or just been turned off to avoid burns.

●Please unplug it during long-term shutdown, but please do not pull hard.

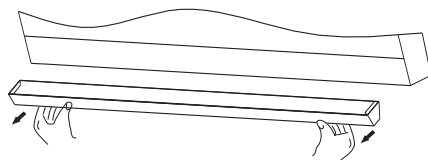

Removal of Components

⚠ Warning

- 1.The machine body needs not to be disassembled in ordinary conditions. Disassembly shall be operated by professional serviceman.
2. The electricity must be cut off before clean, installation or maintenance of range hood.

Note: The installation procedures are in reverse with the removal. Please wear protective gloves during operation to prevent the sharp edge of metal from hurting your hands.

Removal of light

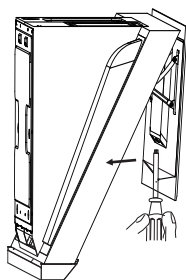

Keep pressing the cleaning icon to unfold smoke deflector, and unplug the power plug. Removing the two screws on the small cover plate by a screwdriver, and take the small cover plate as per the direction of the arrow.

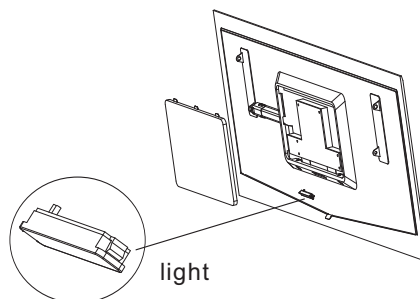

Push the light by hand from inside, and then disconnect the wire for repair and replacement.

Removal of switch

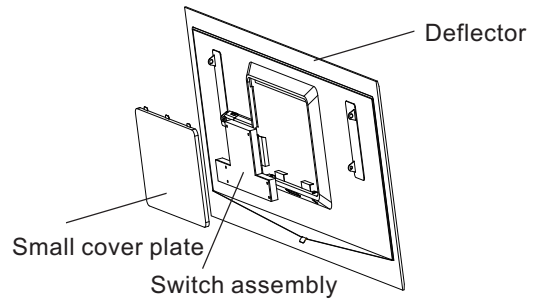
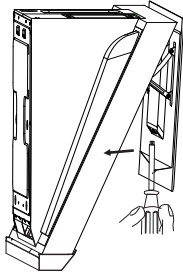

Keep pressing the cleaning icon to unfold smoke deflector, and unplug the power plug. Removing the two screws on the small cover plate by a screwdriver, and take the small cover plate as per the direction of the arrow.

Take out the switch assembly and unplug the connection line for maintenance and replacement.

Removal of filter screen

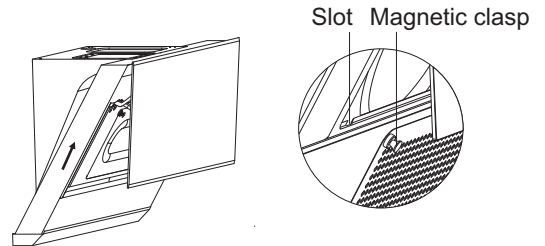
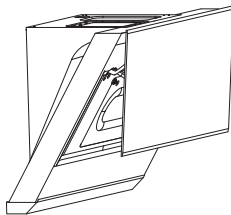

Long press on the icon of cleaning reminder will make the smoke deflector open.

Hold the two magnetic clasps with slightly outward force to make the filter no longer be sucked. Then lift the filter screen as per the arrow direction to make it out of slot. At last, take the filter screen outward for cleaning.

Removal of the whole body

Removal steps

1. Keep pressing the cleaning icon to lock the smoke deflector in the open condition. Then take off the filter screen according to filter removal steps and unscrew four screws on the retaining ring.
2. Close the smoke deflector and pluck the power plug;
3. Screw out the screws on the back board to remove it. Then unscrew each four screws of the air outlet and the border of air passage and remove the air passage;
4. Unscrew the cap clockwise, and take out of the impeller vertically;
5. Take out of the lamp according to the lamp removal steps;
6. Take out of the switch assembly according to the switch removal steps;

Installation steps are opposite to the removal steps.

(When you install the impeller, please add some lubricating oil on the shaft hole of it.)



In general, there is no need to disassemble the hood body.

The remove work needs to be completed by professional maintenance staff.

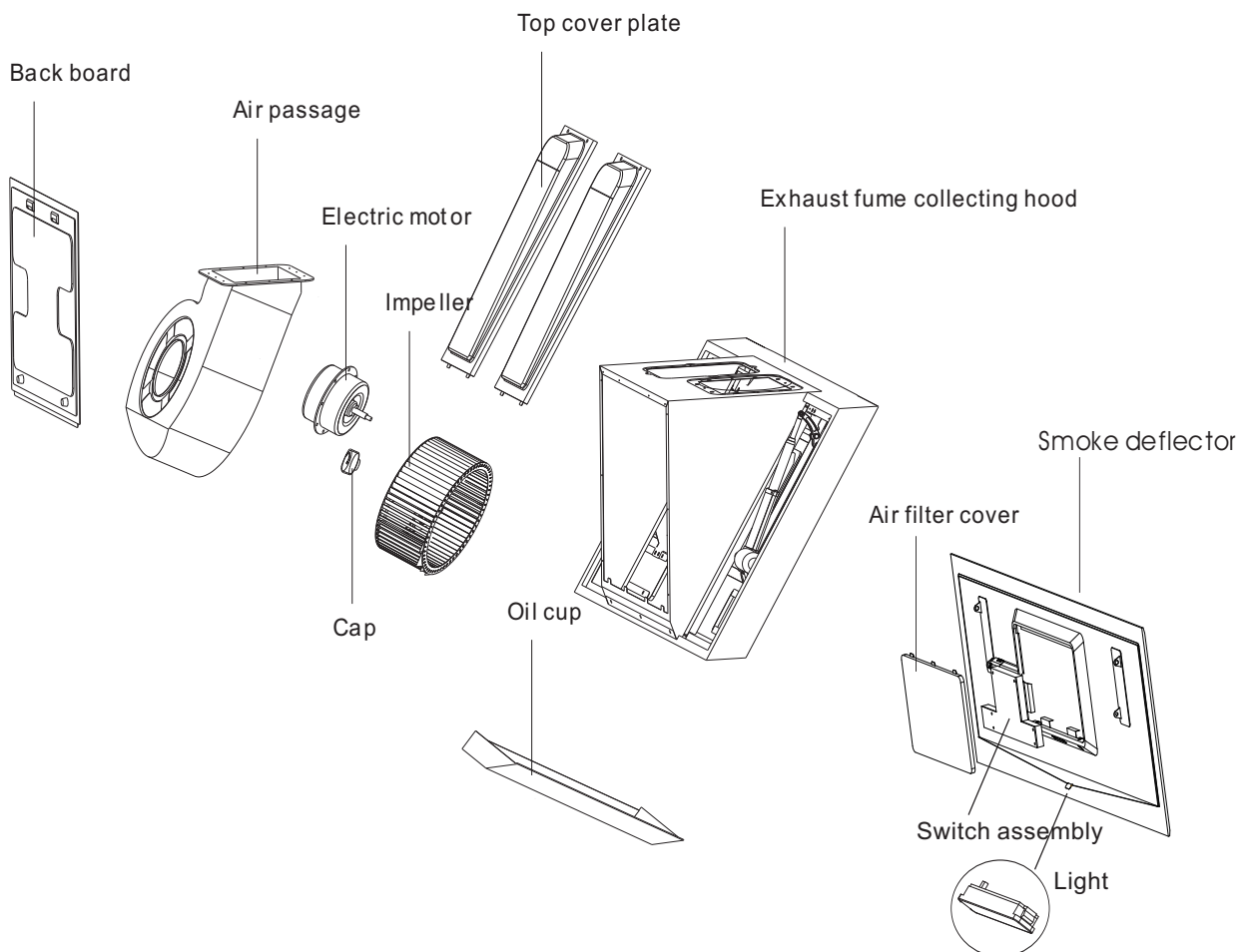

Circuit diagram

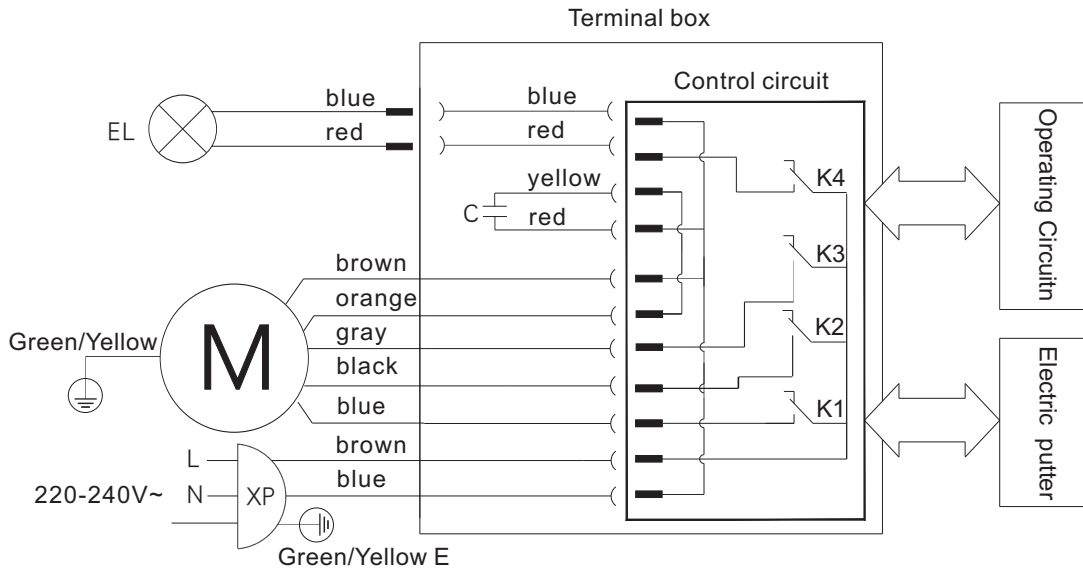

Troubleshooting of General faults

No.	Fault	Cause	⚠Warning
1	No response after pressing any button (e.g. the impeller does not rotate, or the light is off)	The power plug is not connected properly or there is power failure	1. When connecting or replacing the plug, please unplug the power plug. 2. If the range hood's power cords are damaged, it must be replaced by our company's professional maintenance staff. 3. The flame is strictly prohibited being sucked into the machine in case of the accidents.
2	Pressing the light switch, the light is not lit.	The light is damaged or poorly connected.	
3	Induced current exists on the hood body may paralyze hands	The power socket is not grounded well.	
4	Abnormal sound during impeller running	The impeller is loose, and the cap is not tightened.	
5	No oil in the oil cup after a period of time	The body is tilt	
6	After pressing the air flow key and during the opening of the smoke deflector, there are some beeps or the smoke deflector cannot open at all.	The driving circuit of the electronic push rod or the push rod itself malfunctions, or the wire of the push rod is in poor contact.	

Model: A670

Edition: A/0

Publication Date: August,1,2017

ROBAM