

5

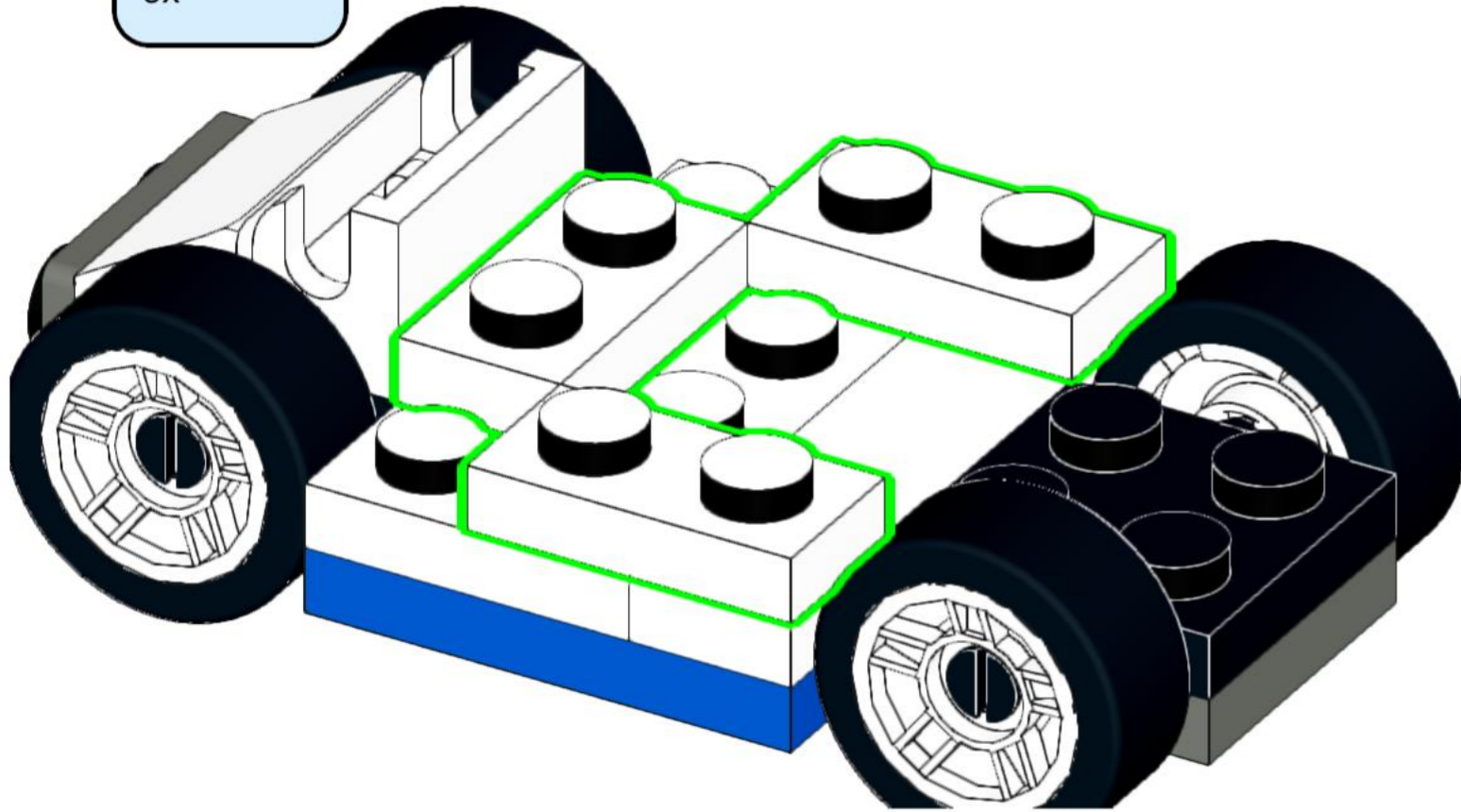

6

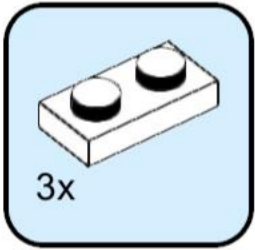
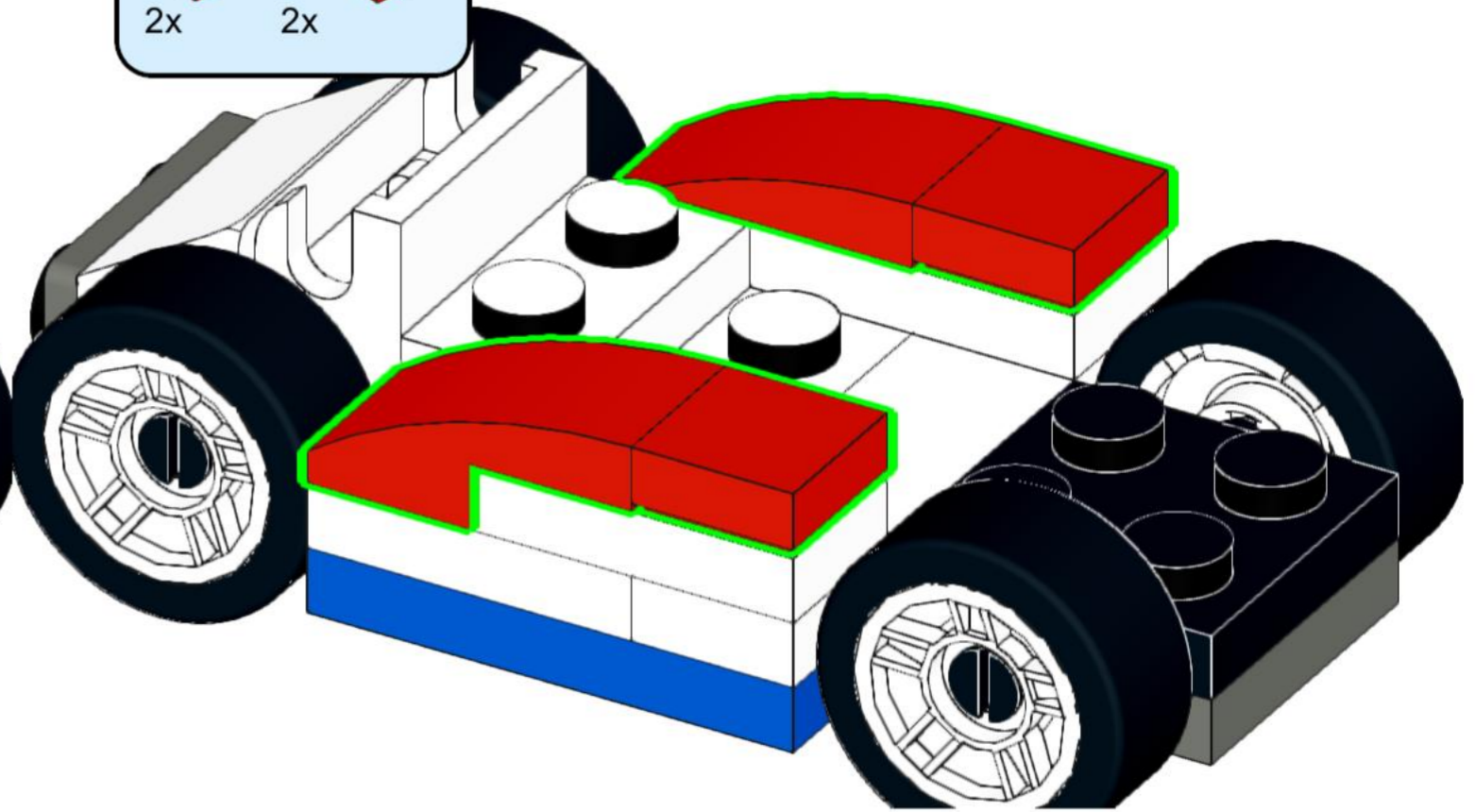
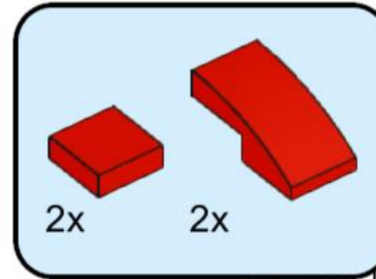

7

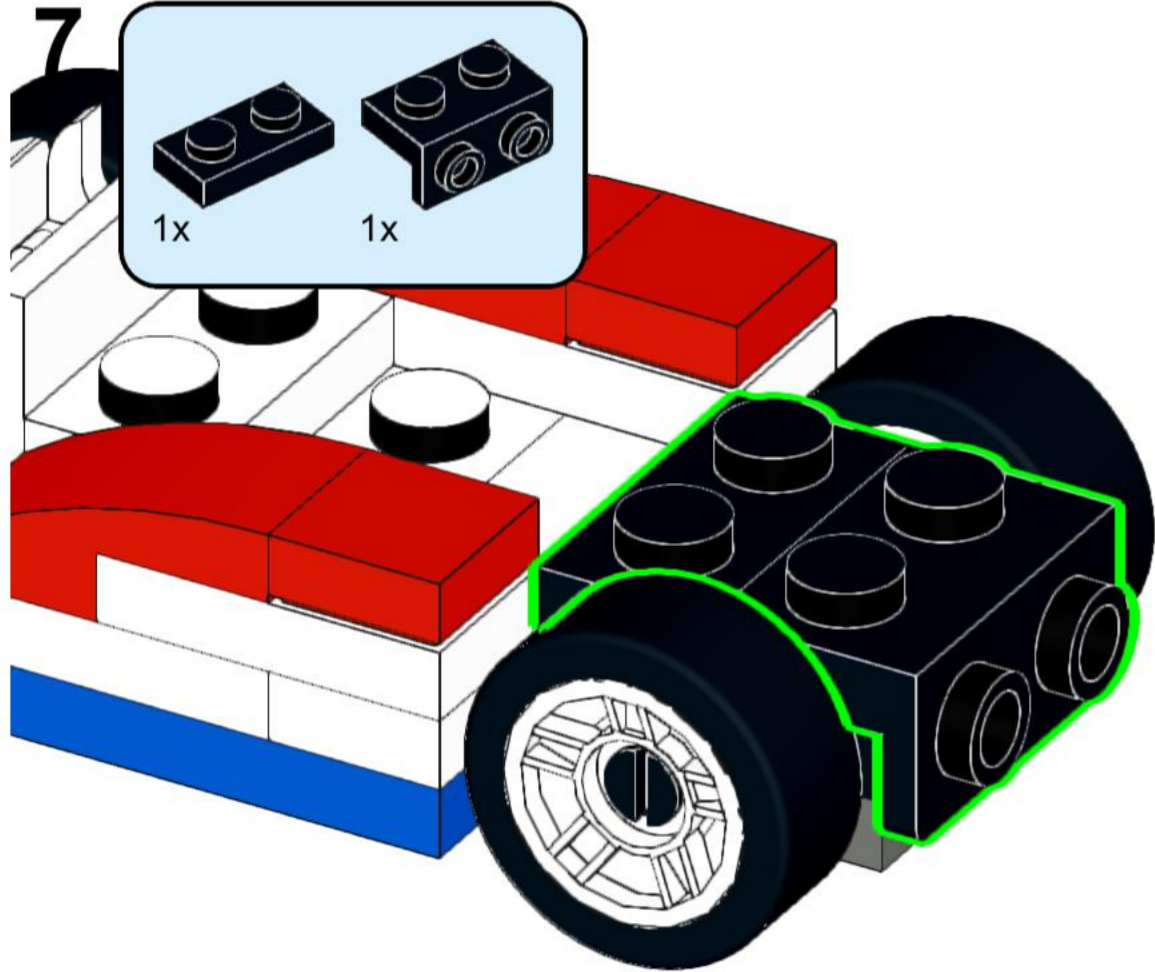
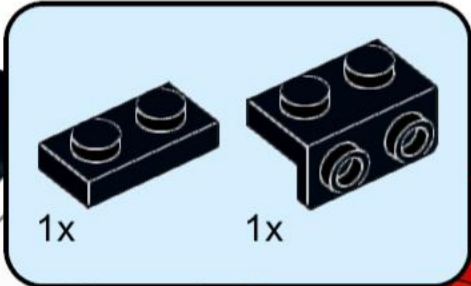

8

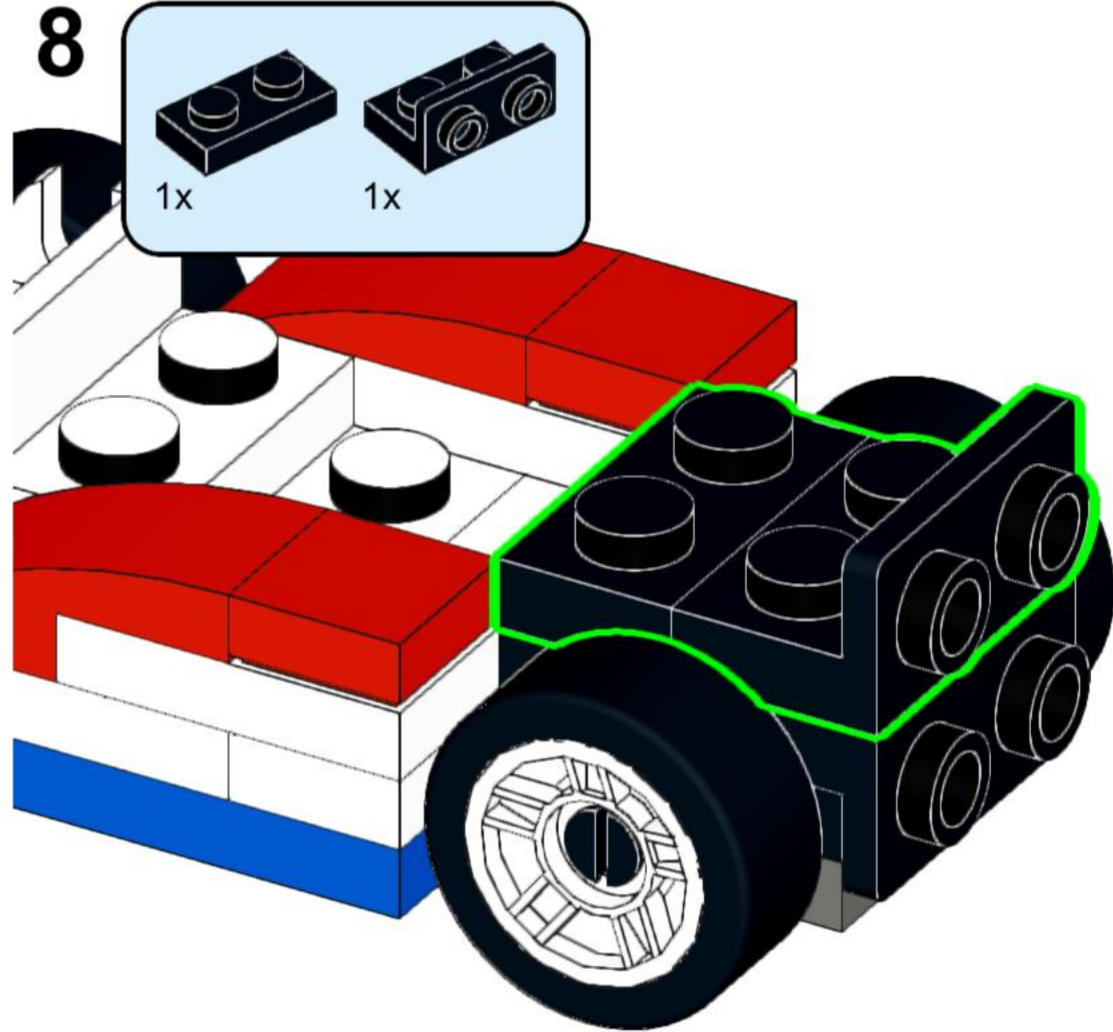
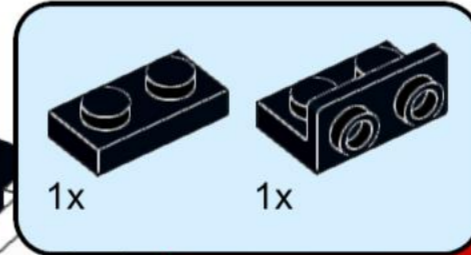

9

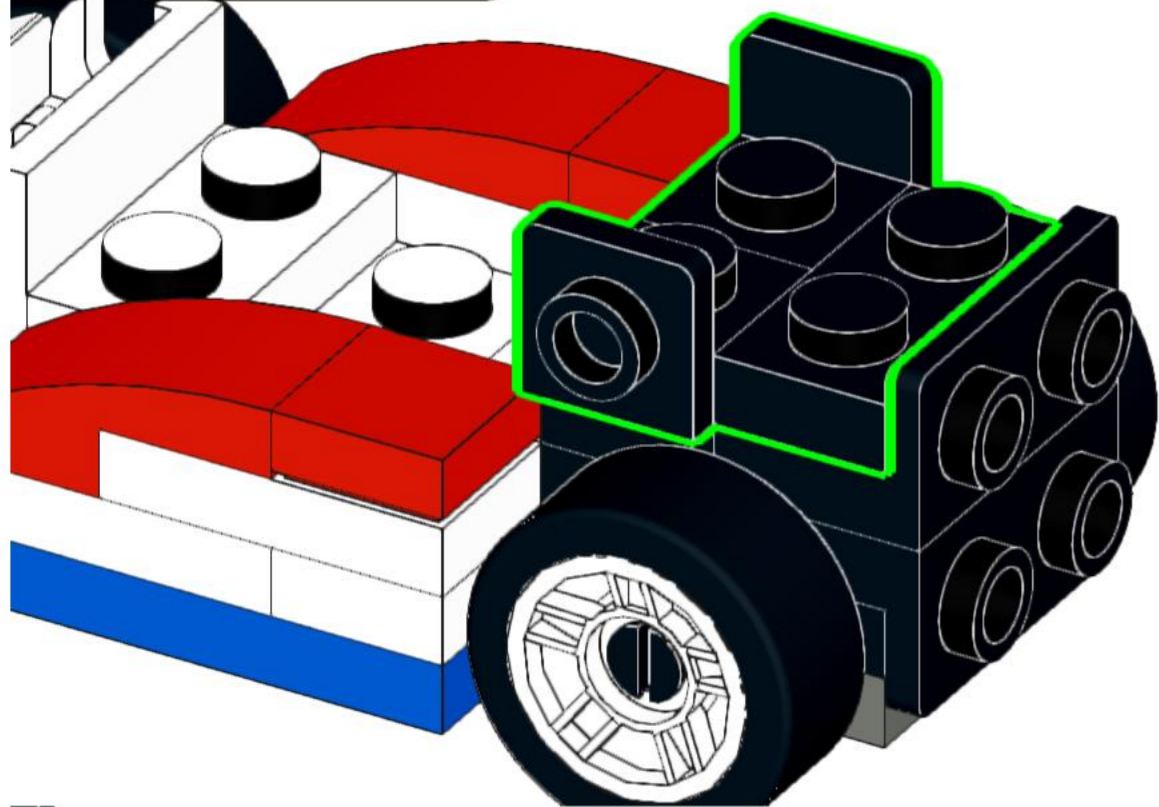
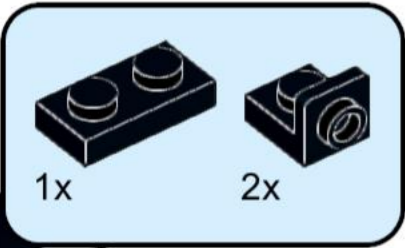

10

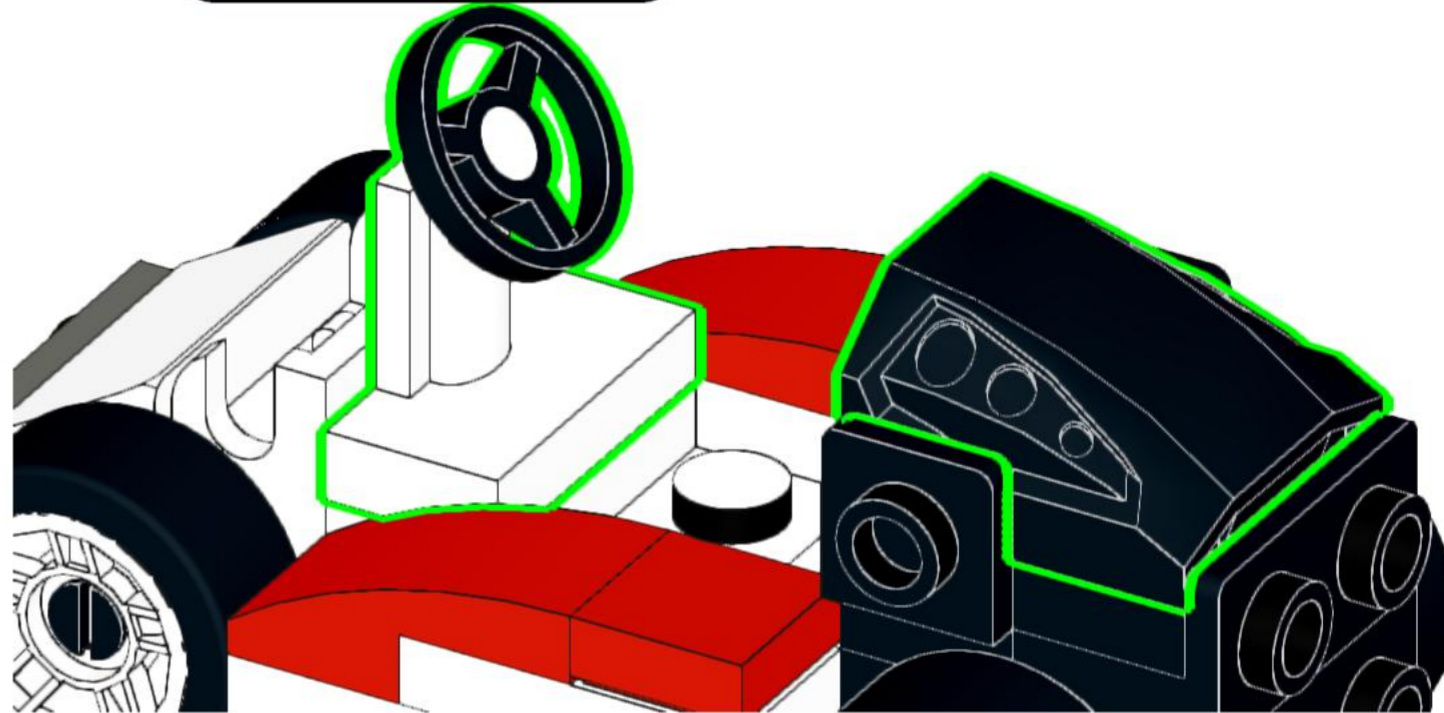
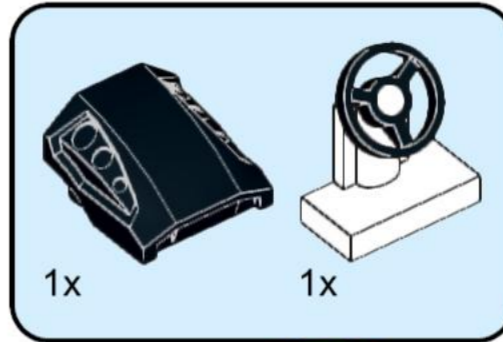

11

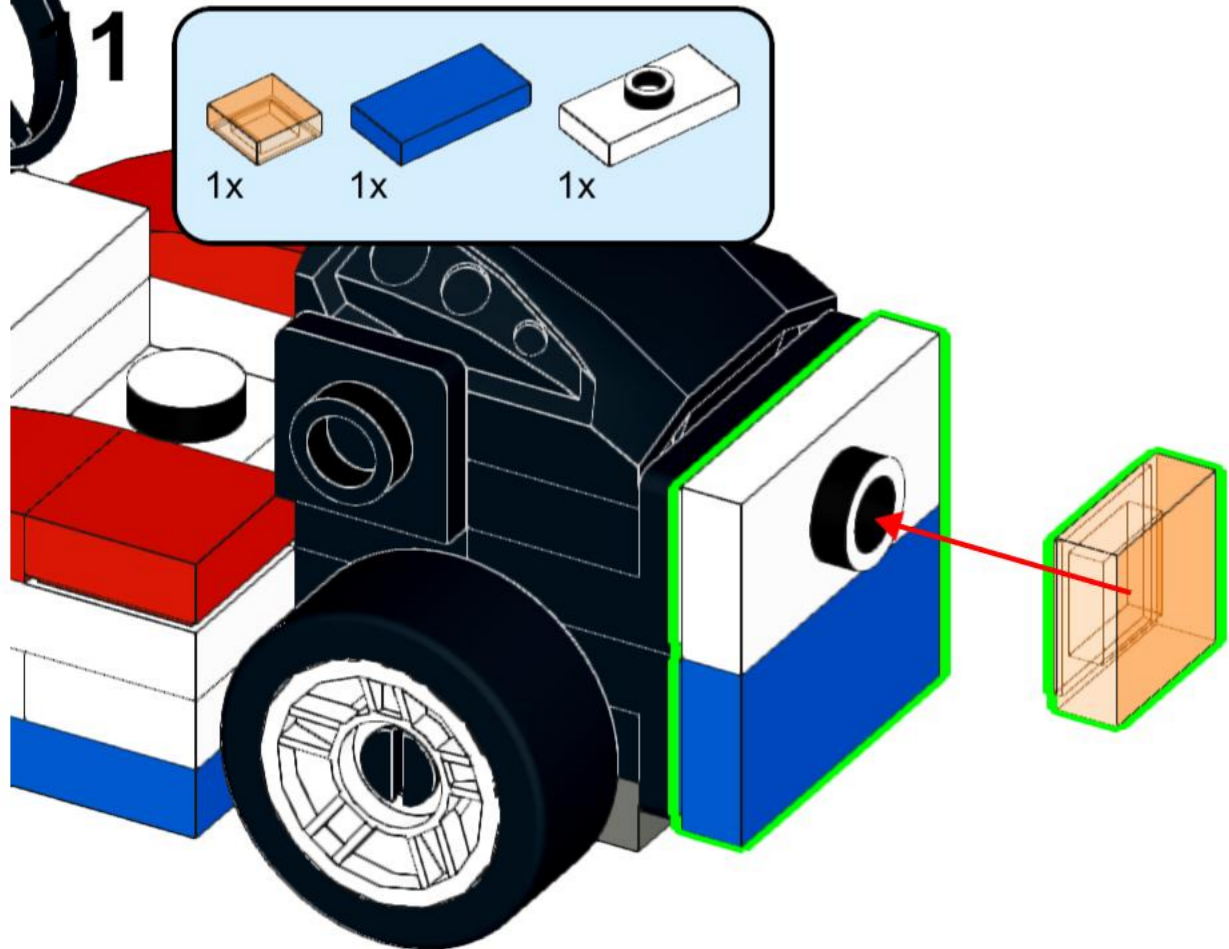
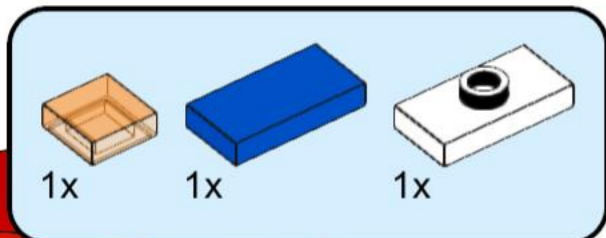

12

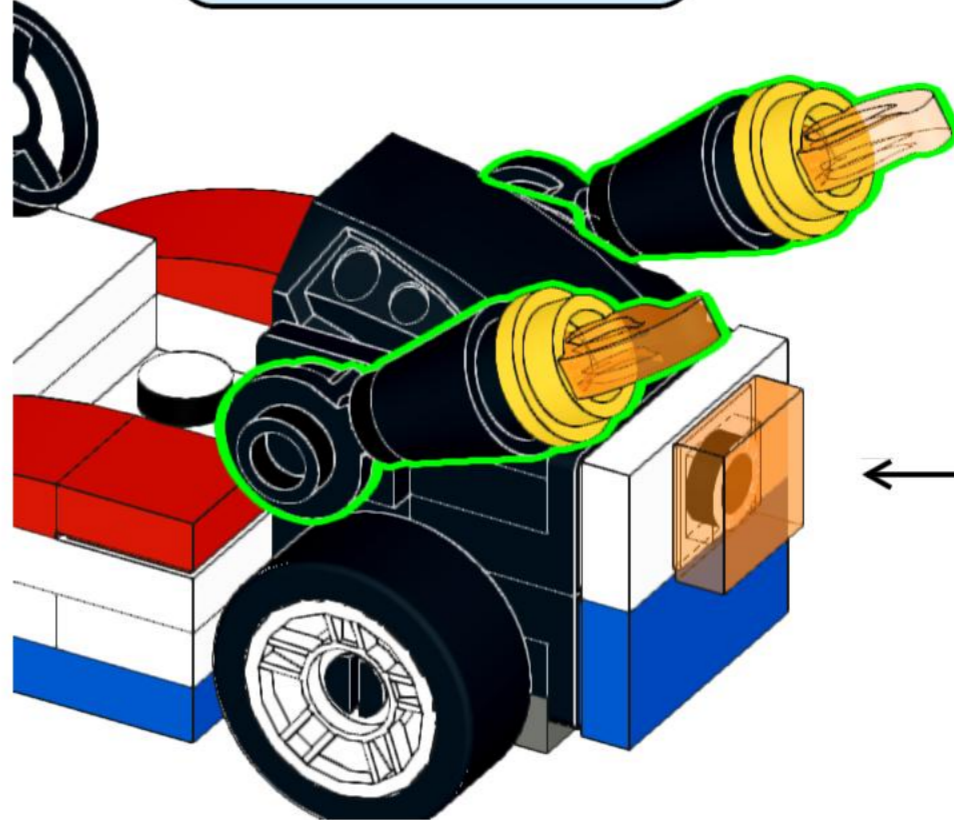

1



2



2x

13

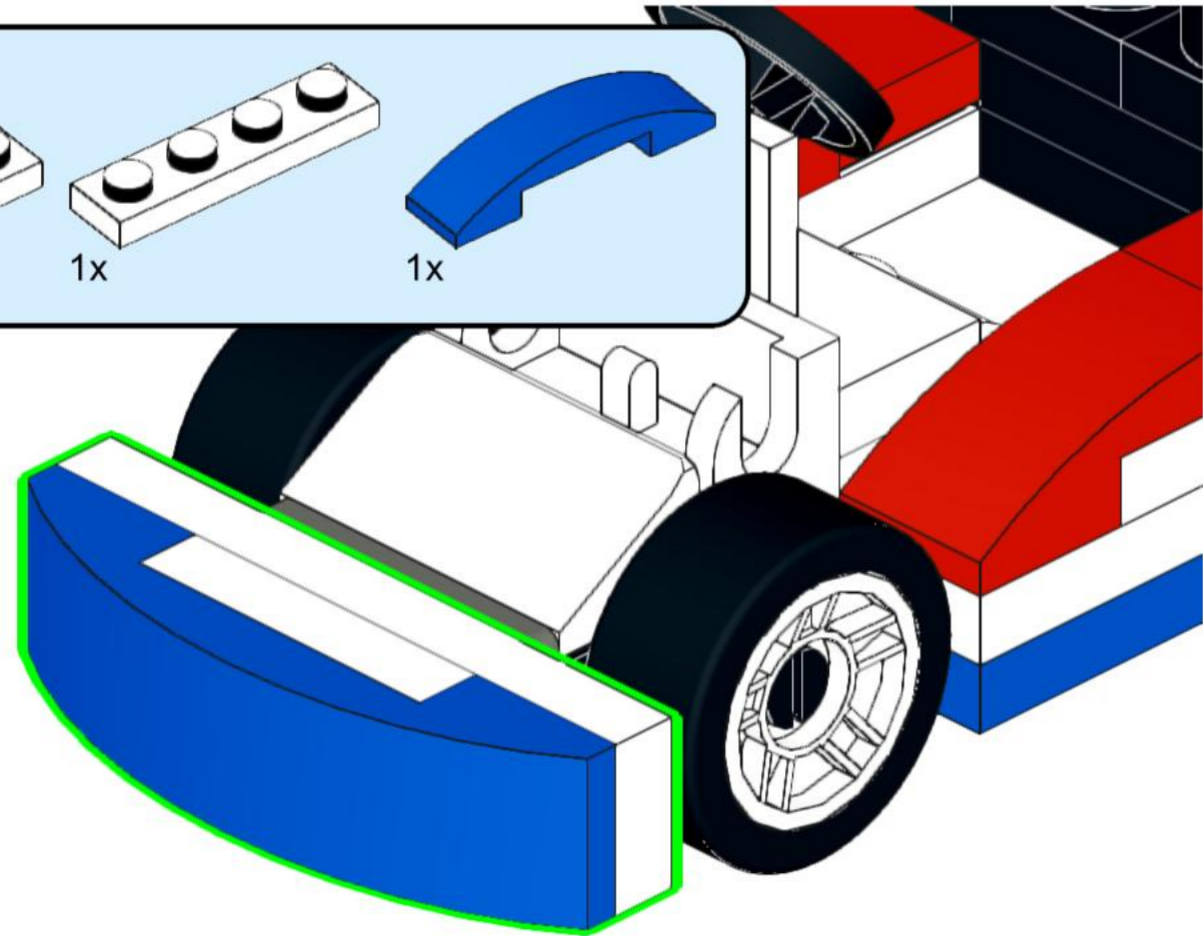
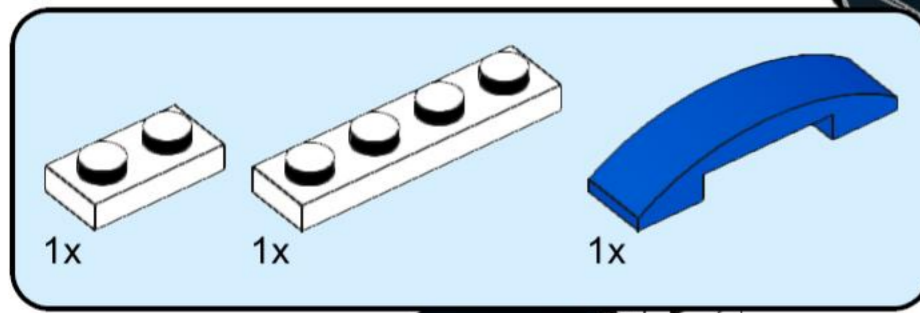

14

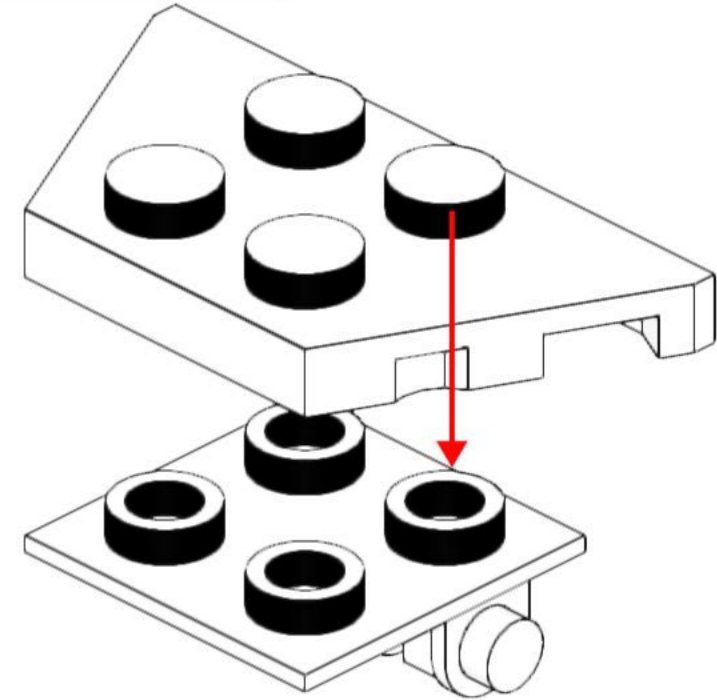
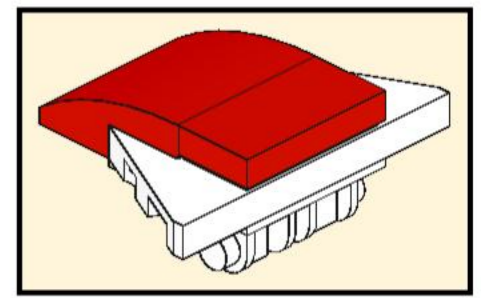
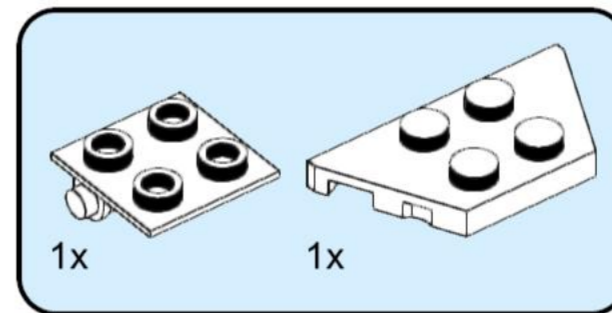

15

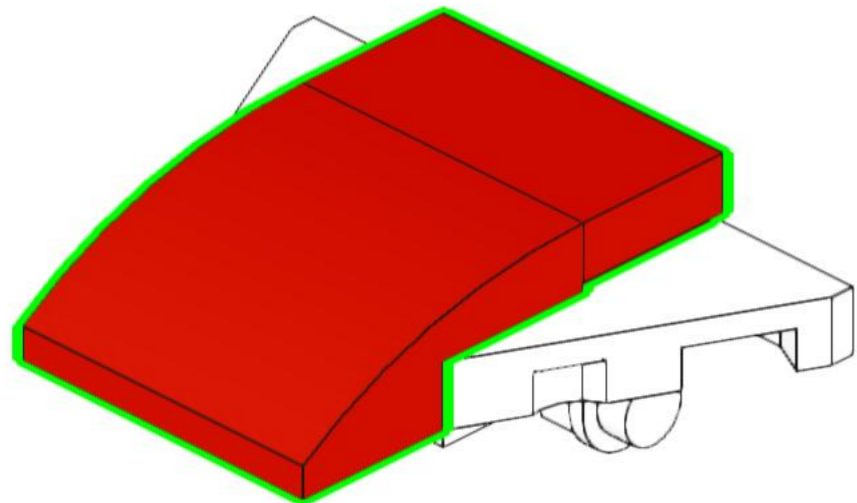
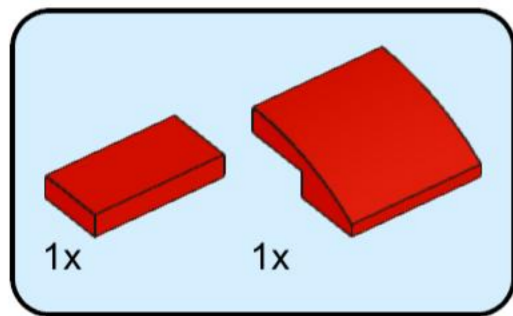

16

