

MSI-3460

Challenger 3

Technical Manual



An ISO 9001 registered company
© Rice Lake Weighing Systems. All rights reserved.

Rice Lake Weighing Systems® is a registered trademark of
Rice Lake Weighing Systems.

All other brand or product names within this publication are trademarks or
registered trademarks of their respective companies.

All information contained within this publication is, to the best of our knowledge, complete
and accurate at the time of publication. Rice Lake Weighing Systems reserves the right to
make changes to the technology, features, specifications and design of the equipment
without notice.

The most current version of this publication, software, firmware and all other product
updates can be found on our website:

www.ricelake.com

Contents

- 1.0 Introduction..... 1**
 - 1.1 Features 1
 - 1.2 Options 1
 - 1.3 Safety 2
 - 1.4 MSI-3460 Front Panel 3

- 2.0 Operation..... 4**
 - 2.1 Power 4
 - 2.2 Zero..... 4
 - 2.3 Tare..... 4
 - 2.3.1 View Tare 5
 - 2.3.2 Clear Tare..... 5

- 3.0 Installation..... 6**
 - 3.1 Unpacking 6
 - 3.2 Assembly..... 6
 - 3.3 Battery Pack 7
 - 3.4 Battery Charger..... 7

- 4.0 Setup..... 9**
 - 4.1 Set Function Key 10
 - 4.1.1 Test 10
 - 4.1.2 Total 11
 - 4.1.3 View Total 11
 - 4.1.4 Net / Gross..... 11
 - 4.1.5 Learn 11
 - 4.1.6 Peak Hold..... 11
 - 4.1.7 Units..... 12
 - 4.1.8 Print 12
 - 4.2 Auto- Off 12
 - 4.3 Sleep..... 12
 - 4.4 Display Brightness..... 13
 - 4.5 Setpoints..... 13
 - 4.6 Total Mode 14
 - 4.7 Filter Setup 15
 - 4.8 Unit 16
 - 4.9 Battery Life 16

- 5.0 Calibration 17**
 - 5.1 Calibration Switch Access 17
 - 5.2 Standard Calibration 17
 - 5.3 Initial Calibration..... 18
 - 5.4 Guidelines for Capacity and Resolution 19
 - 5.5 Constant Calibration (C-Cal) 19
 - 5.6 Standard Menu 20
 - 5.7 Auto Zero Maintenance (AZM) 21
 - 5.8 Zero Power Up (0.P-UP) 21
 - 5.9 Filter 22

- 6.0 Communications..... 23**



Technical training seminars are available through Rice Lake Weighing Systems. Course descriptions and dates can be viewed at www.ricelake.com/training or obtained by calling 715-234-9171 and asking for the training department.

6.1 Printer / Serial Output Setup	23
6.1.1 Standard Print Strings	23
6.1.2 Control Modes	24
6.1.3 Printer Output Setup	24
6.2 RF Network Setup	25
6.2.1 802.15.4 RF Network Setup	25
6.2.2 FCC Statement (for 802.15.4 Option)	27
6.2.3 International RF CERTS (For 802.15.4 OPTION)	27

7.0 Maintenance and Troubleshooting 28

7.1 Troubleshooting	28
7.2 Service Counters	29
7.3 Software Update	30
7.4 MSI-3460 Challenger 3 Dimensions	32
7.5 Specifications	33



Rice Lake continually offers web-based video training on a growing selection of product-related topics at no cost. Visit www.ricelake.com/webinars

1.0 Introduction

The *MSI-3460 Challenger 3* is a combination of the sound and proven mechanical design of the industry standard *Challenger* with today's most advanced electronics. It provides a superb feature set unmatched by any scale in its class or price range. The multi-purpose hanging scale is ideal for situations in which headroom is at a minimum. The *MSI-3460* is versatile, reliable, accurate and easy to operate. The *MSI-3460* is designed to meet or exceed the requirements of all regulatory agencies. RF remote control and remote display options are available to further enhance the safety and usability of the *MSI-3460*.



This manual can be viewed or downloaded from the Rice Lake Weighing Systems website at www.ricelake.com/manuals

Warranty information can be found on the website at www.ricelake.com/warranties

1.1 Features

- Meets or exceeds U.S. and international safety and environmental standards
- Provides up to 50 hours of weighing time when utilizing the automatic sleep mode
- Automatic power off conserves battery life by turning off after sensing no activity during set amount of time
- Automatic sleep mode preserves the battery life by dimming the LED display after a set number of minutes of no activity
- Rugged construction throughout. Buttons are sealed and rated for over one million operations
- Precise high resolution (2500 division standard and up to 10,000 possible) 24 bit A/D conversion coupled with advanced RISC micro controller provides world class features and accuracy
- Five large, 1.5" (38 mm) LED digits for clear weight reading from a distance
- Easy digital calibration assures reliable, repeatable measurements. Calibration can be performed without test weights using C-Cal technology
- Selectable for lb/kg unless prohibited by Legal for Trade regulations
- Automatic or manual weight totalization for loading operations
- Easily customized for special applications
- High-speed PEAK mode for wire and rope stress analysis
- Three setpoints can be set for any in-range weight for operator alerts or process control
- ScaleCore™ technology provides quick and easy software updates and backup for calibration and setup
- Two service counters ensure load train safety by warning the user to perform a load train safety check when the lift count gets high or the scale has been overloaded repeatedly

1.2 Options

- RF remote controller
- RF modem for connectivity to MSI-8000 RF Remote Display and/or remote receiver Model MSI-7000/1 RF Receiver and Remote Scoreboard
- MSI-8000 RF Display
- 85-265 VAC input power
- Audible alarm (triggered by setpoint 1)

1.3 Safety

Safety Signal Definitions:



Indicates an imminently hazardous situation that, if not avoided, will result in death or serious injury. Includes hazards that are exposed when guards are removed.



Indicates a potentially hazardous situation that, if not avoided could result in serious injury or death. Includes hazards that are exposed when guards are removed.



Indicates a potentially hazardous situation that, if not avoided, could result in minor or moderate injury.



Indicates information about procedures that, if not observed, could result in damage to equipment or corruption to and loss of data.

General Safety



Do not operate or work on this equipment unless this manual has been read and all instructions are understood. Failure to follow the instructions or heed the warnings could result in injury or death. Contact any Rice Lake Weighing Systems dealer for replacement manuals.



Failure to heed may result in serious injury or death.

Do not allow minors (children) or inexperienced persons to operate this unit.

Do not stand near the load being lifted as it is a potential falling hazard. Keep a safe distance.

Do not use for purposes other than weight taking or dynamic load monitoring.

Do not use any load bearing component that is worn beyond 5% of the original dimension.

Do not use the scale if any of the components of the load train are cracked, deformed, or show signs of fatigue.

Do not exceed the rated load limit of the scale, rigging elements, or the lifting structure.

Do not allow multi-point contact with the hook, shackle, or lifting eye of the scale.

Do not allow high torque on the scale unless it is specifically designed for high torque.

Do not make alterations or modifications to the scale or associated load bearing devices.

Do not use improperly rated or sized shackles. Use only MSI recommended shackles.

Do not remove or obscure warning labels.

For guidelines on the safe rigging and loading of overhead scales and dynamometers, read the MSI Crane Scale Safety and Periodic Maintenance Manual, PN 153105 (available at www.ricelake.com).

Keep hands, feet and loose clothing away from moving parts.

There are no user-serviceable parts within the MSI-3460. Any repairs are to be performed by qualified service personnel only.

1.4 MSI-3460 Front Panel



Figure 1-1. MSI-3460 Front Panel





Item No.	Key/LED	Description
1	 POWER	Turns the unit on and off When the indicator is in setup mode, cancels action and returns to prior level without saving
2	 ZERO	Used to zero out residual weight on the scale In setup mode, stores changes and returns to the prior level
3	 TARE	Removes the weight of containers, trucks or carriers and places the scale in the Net weight mode functions as tare in, tare out. To view gross weight without resetting the tare value, program the USER key as NET/GROSS .
4	 F USER	Programmable to user-selectable functions. See Section 4.0 on page 9. Defaulted is TEST
5	MOTION	Indicates the weight has not settled within the motion window. When lit, scale will not zero, tare or total.
6	SETPOINTS	User-programmable setpoints for early overload warnings. Blue LED - Setpoint 1 and 2 Red LED - Setpoint 3
7		Center-of-Zero – Indicates the weight is within 1/4 d of zero.
8	ACK	Acknowledge LEDs are used to provide feedback to the operator. <ul style="list-style-type: none"> • Blue LED - Incoming remote commands have been received. • Red LED - Lights momentarily when enabled. Lights to acknowledge Auto-Total operation.
9	RF	Indicates carrier detect for RF remote display equipped unit. An illuminated LED indicates the MSI-3460 and remote display are linked. On units equipped with the RF remote control, the LED is illuminated when a remote command is received for a half second.
10	LO BATT	Displays when approximately 10% of battery life remains, blinks when automatic shutdown is imminent.
11	X1000	Used with TOTAL LED, allows accumulation of weight beyond the five digit display capacity.
12	TOTAL	Indicates scale is displaying the Total weight. This is a temporary display lasting less than five seconds.
13	GROSS	Indicates the scale is in the Gross weight mode. All hook weight is displayed minus any zero offset.
14	NET	Indicates the scale is in Net weight mode. A tare weight is subtracted from the gross weight.
15	PEAK	Indicates the scale is in peak hold mode.
16	kg	Indicates weight display is in kilograms.
17	lb	Indicates weight display is in pounds.
18	-----	5-Digit 1.5"/3.8 mm high brightness LED weight display.
19	-----	Light sensor for auto brightness control.
20	-----	Wire seal-able calibration port.

Table 1-1. Front Panel Keys and Annunciators

2.0 Operation

The following sections describe the basic operation of the *MSI-3460*.



Note *If a function key does not work as expected, it is probably not set up to support the key. For example, if the Function Key is set for TOTAL, the TOTAL mode must also be set up in the Setup Menu.*

2.1 Power

To turn on the power, press . The following displays in order:

- LED lights all segments at full brightness as a display test
- Display brightness changes to the setting determined in the display menu
- Software version number displays
- The unit enters weigh mode

2.2 Zero

Press  to take out small deviations in zero when the scale is unloaded. See Section 2.3 on page 4 for zeroing (taring) package or pallet weights.

The zero key can be used in **GROSS** or **NET** mode.



Note



- *The backup memory in the unit stores the zero reading and retains it even if the power fails.*
- *Zeroing while in net mode will zero the gross weight causing the display to show a negative tare value.*
- *The scale must be stable within the motion window. The unit will only zero if  is on and there has been no activity for two seconds.*
- *The scale will accept a zero setting over the full range of the scale (NTEP and other Legal for Trade models may have a limited zero range). Zero settings above 4% of full scale will subtract from the overall capacity of the unit.*

Example: If 100 lb on a 1000 lb scale is zeroed, the overall capacity of the scale will reduce to 900 lb, plus the allowed over-range amount.

2.3 Tare



Tare is used to zero out a known weight such as a packing container or pallet and display a **NET** weight. The **TARE** function is defined as a **Tare-In** or **Tare-Out** operation.

To tare the scale:

1. Place the packing container/pallet on the scale.
2. Press  to enter a tare value. The *MSI-3460* stores the current weight as a tare value and subtracts the value of the container/pallet from the gross weight.  displays and the weight mode changes to **NET**.
3. Add the product to the packing container/pallet. The **NET** weight is displayed.

2.3.1 View Tare

To view the gross weight without clearing the tare value:

1. Program  to the **NET/GROSS** function. See Section 4.1.1 on page 12.
2. Press , to toggle between net and gross values. This will only work if a tare value has been established.



Note

- *The backup memory in the MSI-3460 stores the Tare reading and can restore it even if power fails.*
- *Only positive gross weight readings can be tared.*
- *The  must be on, indicating weight reading is stable.*
- *Setting or changing the tare has no effect on the gross zero setting.*
- *Taring will reduce the apparent over range of the scale.*

Example: Taring a 100 lb container on a 1000 lb scale, the scale will overload at a net weight of 900 lb (1000-100) plus any additional allowed overload (usually 4% or 9d).

- *The RF Remote Control has a Net/Gross permanently available.*

2.3.2 Clear Tare

To clear a saved tare value, press . The **GROSS** weight will display.

3.0 Installation

The *MSI-3460* installs easily by hanging it on a crane using properly sized rigging (hooks, shackles, slings).



WARNING Refer to the *Crane Scale Safety and Periodic Maintenance Manual (PN 153105)* for safe loading and rigging guidelines when installing the model *MSI-3460*.

Regular maintenance inspections of the lifting system should be performed to ensure safety. Pay particular attention for signs of stress on any element in the load train.

Use the appropriate interface hardware for the capacity and design of the scale.

- Rice Lake Weighing Systems can supply the *MSI-3460* with oversize lifting eyes or shackle interfaces, if the interface hardware does not fit properly.
- Install the scale using adaptive rigging if the crane hook is too large to fit in the lifting eye with single point interface.
- Use a shackle or ring to attach the multiple lines to keep a single point attachment to the scale if multiple attachments are needed.



Important Using an oversize shackle or hook to interface with the *MSI-3460* can cause off center loading and stress points that will reduce the life of the lifting eye or hook. Single point attachments are necessary to ensure the safety and accuracy of the scale system.

3.1 Unpacking

Ensure that all assembly parts are accounted for when unpacking the scale from the shipping container. Check the scale for any visible damage and immediately report any damage to the shipper. Rice Lake Weighing Systems recommends using the original shipping container when shipping or transporting the *MSI-3460*.

3.2 Assembly

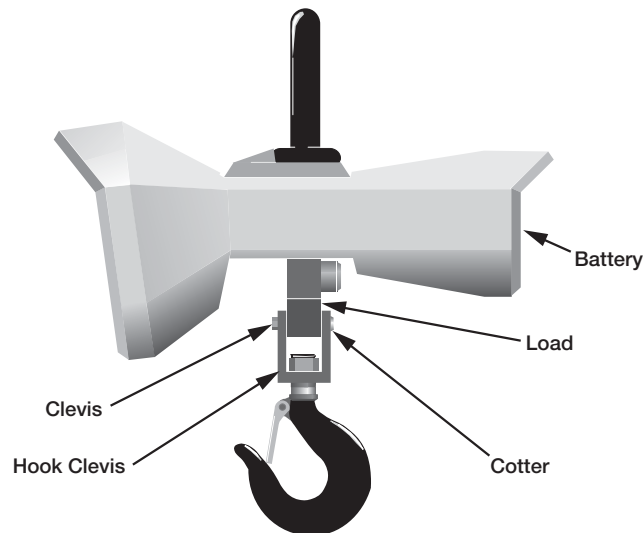

Figure 3-1. *MSI-3460* Assembly

1. Slide the hook clevis over the load cell with the open end of the hook toward front of the scale.
2. Align the holes of clevis and load cell.
3. Slide the clevis pin through the clevis and load cell holes.
4. Lock the clevis pin in place with a cotter pin. Bend the cotter pin.



WARNING The scale will be unsafe for use if the clevis pin is not properly secured with the cotter pin.

5. Slide the battery pack into the battery compartment. The battery will automatically engage with its connectors.
6. Secure the battery pack by turning the two locking fasteners on the access door clockwise 1/4 turn.

3.3 Battery Pack

The *MSI-3460* is powered by a 6V rechargeable battery. The battery door is part of the battery pack.

The scale will operate for up to 50 hours before requiring recharging, using the battery life conserving modes included in the scale.

- Auto Off – turns the scale off after a set amount of time of no scale activity. See Section 4.2 on page 12.
- Sleep mode – dims the display after a set amount of time of no scale activity. See Section 4.3 on page 12.
- Display Intensity – LED intensity can be lowered to save battery power. See Section 4.4 on page 13.
- Battery Life – when set to long, the system is placed into a sleep state for several seconds at a time if there is no change in weight. See Section 4.9 on page 16.

Charging time for a completely discharged battery is up to eight hours. A spare battery pack is recommended to keep the *MSI-3460* in continuous operation.



Figure 3-2. Battery Pack Removal

To Remove the Battery Pack

1. Turn the two fasteners on the access door counter-clockwise a 1/4 turn.
2. Grasp the handle and pull the battery pack straight out. The battery will disengage from its connectors.



Note Store the batteries between -4°F and 122°F (-20°C and $+50^{\circ}\text{C}$) to obtain maximum service life. Stored batteries should be recharged every three months. The battery is fully charged when the status indicator on the charger is flashing.

3.4 Battery Charger

The charger is a three-stage float charger that can be left on the battery indefinitely. It has a dual color LED to indicate the charging state:

- RED – fast charge mode.
- GREEN – charged or float charge.

Charge the Battery

1. Remove the battery from the scale.
2. Plug the battery charger into an AC power receptacle. The input voltage is universal from 115/230 VAC, 50/60 Hz. If the power input plug doesn't match, contact Rice Lake Weighing Systems for information on international plugs.
3. Slide the battery charger connector plate over the top of the battery until the battery terminals mate with the charger connectors, as viewed through the two observation holes.
4. Six to eight hours is required to recharge a fully discharged battery. Partially discharged batteries will finish the charge faster.



Figure 3-3. Battery Charger











Note



To obtain maximum service life from the batteries, the manufacturer suggests recharging after each 20 hours of use. Continuous deep discharging reduces the maximum battery life cycle estimated at 2000 cycles.

A second battery is recommended to enable continuous scale use. Keep one on the charger while the other is in service.

4.0 Setup

The following keys can be used when navigating through the menus while setting up the *MSI-3460*.

-  exits setup without saving changes. *CRNCE* displays briefly and unit enters weigh mode.
-  functions as the **Enter/Select** key
-  functions as the **Scroll** key
- To enter a decimal point, press  while the digit is blinking.
- Press  to save and go back one level. Press it again to return to weigh mode, *STORE* displays briefly.
- To change/correct a digit, press  to step back one digit and use  and  to change the digit

To enter into the *MSI-3460* setup menu, press  and  simultaneously.

Parameters	Choices	Description
<i>Func 1</i> <i>Func 2</i>	<i>OFF</i>	Function User Key 1 – user definable key that can be programmed to one of several functions Function User Key 2 – user definable key that can be programmed to one of several functions. Only available if an RF remote is used
	<i>TEST</i>	Test Display – Section 4.1.1 on page 10.
	<i>Total</i>	Total – Section 4.1.2 on page 11.
	<i>u-Total</i>	View Total – function always available on the RF Remote, see Section 4.1.3 on page 11.
	<i>Net/Gross</i>	Net/Gross – function always available on the RF Remote, Section 4.1.4 on page 11.
	<i>LEARN</i>	RF Remote Learn – Section 4.1.5 on page 11.
	<i>P-Hold</i>	Peak Hold – Section 4.1.6 on page 11 Function not available or non-functional in OIML R76 or NTEP HB44 modes.
	<i>Units</i>	Units – See Section 4.1.7 on page 12 Function not available or non-functional in OIML R76 & 1Unit modes.
	<i>Print</i>	Print – Section 4.1.8 on page 12.
<i>R-OFF</i>	<i>OFF</i> <i>15</i> <i>30</i> <i>45</i> <i>60</i>	Auto Off Time – prolongs the battery life of the scale by turning power off after the set time (in minutes) that the scale is not in use. See Section 4.2 on page 12
<i>SLEEP</i>	<i>OFF</i> <i>5</i> <i>15</i> <i>30</i>	Sleep – Time (in minutes) before unit will enter the sleep mode See Section 4.3 on page 12
<i>d SPL</i>	<i>LD-1</i> <i>LD-2</i> <i>H1-1</i> <i>H1-2</i> <i>Auto</i>	LED Display Intensity – used to set the display brightness. See Section 4.4 on page 13
<i>Setpt 1-8</i>	<i>OFF</i> <i>CRATE</i> <i>LESS</i>	Setpoint 1 to 8 – used for warnings or process control. See Section 4.5 on page 13







Table 4-1. Setup Menu Parameters

Parameters	Choices	Description
total	OFF tEOn A. LOAd A. LAsE A. H IGH	Total Mode – accumulation of multiple weighments See Section 4.6 on page 14
Filter	OFF LO HI - I	Weight Filter – allows the scale to adjust to situations where there may be movement See Section 4.7 on page 15
Unit	lb kg	Weight Units – toggle units between pounds and kilograms Function not available or non-functional in OIML R76 & 1Unit modes See Section 4.8 on page 16
baTtErE	STANd LONG	Battery Life – sets the options for standard or extended battery life. See Section 4.9 on page 16

Table 4-1. Setup Menu Parameters (Continued)

4.1 Set Function Key

The *MSI-3460* has one user definable key  on the front panel that can be programmed to one of several functions. To set the function key use the following steps:

1. Press and hold  and . *FUnC 1* displays.
2. Press . The current user key function displays.
3. Press  to scroll through the available functions.
4. Press  when the desired function is displayed. *FUnC 2* displays.
5. Press . *StANd* displays briefly and exits setup mode.

4.1.1 Test

The *TEST* function will automatically scroll through the following:

Lights all LEDs at once.

Displays *StANd* followed by the software version number.



Displays *baTtErE* followed by the battery voltage.

Displays *d. tESt* followed by the display counting from 00000 to 99999.





Displays *C-CAL* followed by the C-CAL value.

Other internal tests are performed and if any test fails, an error code will display. See Section 7.1 on page 28 for the troubleshooting guide.

To run a *TEST*:



1. Program the  to *tESt*. See Section 4.1.
2. Press  to start the test. It runs through the complete test and returns to weigh mode.

Single Step Through Test Procedure

1. Press  within two seconds of test start, to enable a single step mode.
2. Press  to scroll through the available test functions.
3. Press  to start or display the individual tests.
4. Press  to exit individual tests.
5. Press  to exit from the test function.

4.1.2 Total



Program the  to *TOTAL*. See Section 4.1 on page 10.

The function that will be performed when pressing , will need to be set in Section 4.6 on page 14. If nothing has been set, nothing will happen when  is set.





Note *The Total mode must be programmed from the Setup Menus before the USER key will function.*

4.1.3 View Total

1. Program the  to *VIEW*. See Section 4.1 on page 10.
2. Press  to activate the total weight display followed by the number of samples.
3. With the Total weight displayed, press  to clear.

4.1.4 Net / Gross

Switches the display between net and gross modes. Net weight is defined as gross weight minus a tare weight. To switch between net mode and gross mode:

1. Program the  to *NET/GROSS*. See Section 4.1 on page 10.
2. Press  to toggle between net and gross values. This will only work if a tare value has been established.

The operator can switch back to gross from net without clearing the tare value. Only clearing or setting a new tare will change the tare value held before switching into Gross Mode.

OIML Legal for Trade units only: The **NET/GROSS** key is a temporary action only. The gross weight is displayed for two seconds and then the display returns to the net mode. The only way to return to permanent gross readings is to clear the tare. See Section 2.3.2 on page 5.

4.1.5 Learn

Learn is used for programming the RF remote control. See the RF remote manual for more details.

4.1.6 Peak Hold

Peak hold only updates the display when a higher weight reading is established.

The peak hold function uses a high speed mode of the A/D converter allowing it to capture transient weights at a far higher rate than typical scales.

Peak hold is cleared and re-enabled with the , that has been set to *P-HLd*. See Section 4.1 on page 10.

Peak hold is not available on NTEP or OIML Legal for Trade certified scales.

4.1.7 Units

Units can be changed in two ways.

- To use the , program it to *Unit*. See Section 4.1 on page 10.
- Change the units with the setup menu. See Section 4.8 on page 16.



Note *Unit switching is not available on OIML certified Legal for Trade scales.*







4.1.8 Print

If the print option is installed, this menu choice will appear. See Section 6.1 on page 23 for setup.

4.2 Auto- Off

The *Auto-Off* feature prolongs the battery life by automatically powering off the unit if no buttons are pressed and there is no change in the load exceeding 10 d for the time period, in minute, set by the user. When a button is pressed or the detected load is in motion exceeding 10 d, the time limit is reset.

When disabled, the unit will only turn off by pressing , or if the battery dies. To set the *Auto-Off* function:





1. Press and hold  and . *FUNC 1* displays.
2. Press  to scroll to *A-OFF*.
3. Press . The current auto off time displays.
4. Press  to scroll through the available times.
5. Press  when the desired time is displayed. *SLEEP* displays.
6. Press  to exit setup and store the settings.



4.3 Sleep

The *Sleep* parameter reduces power consumption by automatically turning off the display during periods of inactivity, in minutes, set by the user. The green acknowledge annunciator blinks at one second intervals to indicate the unit is in the sleep mode. To wake the unit up, a button must be pushed (front panel or RF remote) or the weight must change by 5 d or more.



Note *Sleep must be set to less time than the Auto-Off timer.*

1. Press and hold  and . *FUNC 1* displays.
2. Press  to scroll to the *SLEEP* function.
3. Press . The current sleep time is displayed.
4. Press  to scroll through the available times.





5. Press  when the desired time is displayed.
6. Press  to exit setup and store the settings.

4.4 Display Brightness

The *Display* setup menu is used to set the display brightness. There are four fixed brightness settings and one automatic light sensing brightness setting.



Auto setting automatically detects the ambient light and adjusts the brightness of the display accordingly.

There are four fixed brightness settings, *LO-1*, *LO-2*, *HI-1* and *HI-2*. Lower brightness settings increase battery life.

1. Press and hold  and . *Func 1* displays.
2. Press  to scroll to the *DISPL*.
3. Press . The current setting is displayed.
4. Press  to scroll through the available settings.



Note The display brightness changes when each setting is displayed.

5. Press  when the desired setting is displayed. *5tPt 1* displays.
6. Press  to exit setup and store the settings.

4.5 Setpoints

The MSI-3460 supports eight setpoints. There are three LED outputs that are triggered by the first three setpoints. Setpoints 4 through 8 do not trigger an indication on the MSI-3460, but can be set to control relays or trigger indications that are sent to other peripheral devices either through RS-232 or wireless communication. It comes standard with LED outputs for a triggered set point.

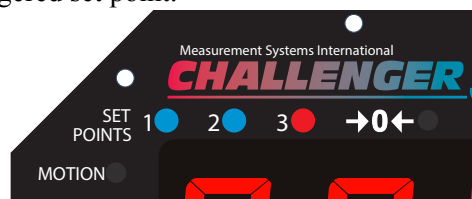

Figure 4-1. Setpoint LED's

The *MSI-3460* has an audible output option that is triggered by Setpoint 1. Contact Rice Lake Weighing Systems for other setpoint output options.











Setpoint	Description
Setpoint Mode	
OFF	Setpoint is not activated
GREAT	Indicates the setpoint will trigger when the weight exceeds a set value
LESS	Indicates the setpoint will trigger when the weight is less than a set value



Table 4-2. Available Setpoint Settings

Setpoint	Description
Setpoint Weight Type	
NETGR	responds to net or gross weight
GROSS	responds to gross weight regardless of the display
TOTAL	responds to the totaled weight
T-CNT	responds to the total count (number of samples)
LFcnt	responds to the number of times the weight has exceeded 25% of capacity

Table 4-2. Available Setpoint Settings (Continued)

To set the setpoint:

1. Press and hold  and . *Func 1* displays.
2. Press  to scroll to the desired setpoint (*SEtPt 1 - 8*).
3. Press . The current setpoint mode is displayed.
4. Press  to scroll to the setpoint mode desired.
5. Press . The current setpoint weight type is displayed.
6. Press  to scroll to the desired weight type.
7. Press . The current setpoint weight value is displayed.
8. Press  to scroll the numbers and  to enter each digit.
9. When the correct value is displayed, press . The next setup menu item is displays.

 **Note** To enter a decimal point, press  while the digit is blinking. To correct a digit, press  to step back.

10. Press  to exit setup and store the settings.

4.6 Total Mode

For the accumulation of multiple weighments, the Total function uses the displayed load, so gross and net readings can be added into the same total.

There are four modes of totalizing, manual and three auto modes.

All modes require that the weight on the scale return below 0.5% (relative to full scale) of **GROSS ZERO** or **NET ZERO** before the next weighment can be added. Applied weight must be $\geq 1\%$ of full scale above **GROSS ZERO** or **NET ZERO** before it can be totaled.

Manual Total

Manual Total (*TELETR*) adds a current weight to a previously accumulated value manually. To add weight to the total it must be greater than 1% of capacity and not yet totaled. This assures that a weight on the scale is only added to the total once.

1. Program the  to *TOTAL*. See Section 4.1 on page 10.

2. With the weight to be added on the scale, press . The acknowledge LED blinks to indicate the weight was accepted and the **TOTAL** annunciator lights. Then the total weight is displayed for five seconds and the number of samples is displayed for two seconds.
3. Repeat steps 1 & 2 until all weight samples have been added.



Note *Total Mode will not function while the scale is in motion, ensure  is on. If the system fails to achieve stable readings, increase the filter setting or increase the size of the scale division (d) in the Init Cal procedure.*

 functions as View Total only until the 1% threshold is exceeded to allow the addition to the total value.

Auto Total







This mode has three variations which are programmed in the Setup menu.

Program the  to **AUTO TOTAL**, it functions as *Auto Total On/Auto Total Off*. See Section 4.1 on page 10.

Setpoint	Description
R. Load	Auto Load – ensures any settled load above the Rise Above threshold will be automatically totaled. The scale must fall below the Drop Below threshold before the next total is allowed.
R. Last	Auto Last – takes the last settled weight to auto total with. The total occurs only once the scale goes below the threshold. This allows the load to be adjusted without a total occurring. Once the load is removed, the scale uses the last settled reading for total.
R. High	Auto High – uses the highest settled reading. This is useful for loads that can't be removed all at once.

Table 4-3. Auto Load Selections





Set Total Mode



1. Press  and  simultaneously. *Func 1* will display.
2. Press  to scroll to *AutoAL*.
3. Press . The currently saved total mode is displayed.
4. Press  to scroll through the choices.
5. With choice displayed, press  to select. *Filter* will be displayed.
6. Press  to exit setup and store the settings.

4.7 Filter Setup







Changing the filter settings allows the scale to adjust to situations where there is a lot a movement in the structure. If the reading is not stable, it can often be improved by increasing the filter setting. Settling time will be longer as the filter setting is increased. However, the *MSI-3460* employs algorithms that speed up large weight changes while still controlling vibration even with high filter settings.

Use the following steps to set up filtering.

1. Press  and  simultaneously. *Func 1* displays.
2. Press  to scroll to *Filter*.
3. Press . The currently saved total mode displays.

4. Press  to scroll through the choices.
5. With choice displayed, press  to select. *Unit* displays.
6. Press  to save and exit to weighing mode.

4.8 Unit







1. Press  and  simultaneously. *Func 1* displays.
2. Press  to scroll to *Unit*.
3. Press  *Unit* displays with lb or kg the display area.
4. Press  to toggle between lb and kg.
5. With the desired choice displayed, press  to select.
6. Press  to save and exit to weighing mode.

4.9 Battery Life

Select either Standard (*Standard*) or Long (*Long*) battery life.

In Long battery life mode, the system is placed into a sleep state for several seconds at a time if there is no change in weight. This disables the display in order to reduce power consumption and increase battery life. After several seconds, the *MSI-3460* will wake up to check for any changes in weight. If there is a change in weight, the unit will stay awake. The unit will also stay awake if it is in configuration mode.

Although long battery life mode can significantly increase battery life, performance of the scale is better in standard battery life mode.

1. Press  and  simultaneously. *Func 1* displays.
2. Press  to scroll to *battery*.
3. Press . The currently saved battery life displays.
4. Press  to toggle between the choices.
5. With choice displayed, press  to select. *Func 1* displays.
6. Press  to save and exit to weighing mode.

5.0 Calibration

The *MSI-3460* is calibrated using standard weights. It is required that the weight used is at least 10% of full capacity in order to achieve rated accuracy.

Example – use at least a 500 kg test weight to calibrate a 5000 kg capacity scale.

Although a single span point is usually adequate for rated accuracy, the *MSI-3460* supports multi-point calibration with up to four span points plus zero.

When adequate test weights are not available, the unit can be calibrated using a calculated Constant Calibration (C-Cal). To use, a previously generated C-Cal number must be known. Rice Lake Weighing Systems supplies replacement load cells with the C-Cal value stamped on the serial number label.

There are three kinds of calibration:

- **Standard Calibration** – this is used for maintenance and routine calibration.
- **Initial Calibration** – is used to set up both the capacity and resolution (*d*) of the scale. It differs from Standard Calibration only in the initial steps. The initial calibration is performed after a calibration reset which completely erases the calibration and setup memory.
- **C-Cal** – if the last calculated C-Cal value is known, the *MSI-3460* can be calibrated without weights.

5.1 Calibration Switch Access

Use the following steps to access the calibration switch on the *MSI-3460* if calibrating the unit using either the standard calibration or the C-Cal calibration.

1. Remove the hex seal screw from the *MSI-3460*.





















Figure 5-1. Calibration Button Seal Screw

2. Using a small non-conductive tool, press the calibration button located behind the hex seal screw. *CAL* is displayed.
3. Replace screw when calibration and setup is complete.

5.2 Standard Calibration

Use the following steps to calibrate the *MSI-3460* using the standard calibration procedure.









1. Place the *MSI-3460* into calibration mode. See Section 5.1.
2. Press . *UnLd* displays. Ensure there is no load on the scale.
3. Press . *0* displays briefly. If the scale is in range *PRSS* is displayed, then *Load 1* displays.
4. Load the scale with a test weight (for a single span point calibration, a test weight of more than 20% of capacity or more is recommended).
5. Press . The current capacity flashes on the display. If loading the scale with the capacity weight, skip to step 8.
6. Press  if using a calibration weight other than capacity. The displays far left digit blinks indicating a number should be entered.







7. Press  to scroll the numbers and  to enter each digit.
8. Press  to save the weight entry. If the cal value is within limits, *PASS* displays briefly, then *Load2*.
9. Press  to save the weight entry. If the cal value is within limits, *PASS* briefly displays then *Load2*.
10. Press  if more cal points are desired or  if a single point cal is needed.
11. Load the scale the next test weight and press  if the weight value is acceptable.
12. Press  to scroll through digit choices and press  to enter the calibration weight value.
13. Press  again to complete the calibration span point. If the cal value is within limits, *PASS* displays briefly, then *Load3* or *Load4* displays.
14. Press  to enter additional span point or  if finished. *CAL d* displays to indicate success.
15. Press  and the display flashes *[-CAL* followed by the *[-CAL* number.
16. Press  to store the calibration. *SETUP* displays.
17. Press  to exit and return to weigh mode.

5.3 Initial Calibration

Use this procedure only if the capacity and count-by (*d*) needs to be modified. The initial steps of the initial calibration will totally erase user setup as well as any previous calibration.

Use the following steps to calibrate using the initial calibration procedure.

1. Turn the *MSI-3460* off.
2. Remove the hex seal screw covering the calibration button. See Section 5.1 on page 17.
3. Press the *Cal* switch and  simultaneously. *RESET* displays.
4. Press  to reset the calibration constants. *SUREP* displays.
5. Press  to reset. *CAL* displays.
6. Press . *Unit* displays.
7. Press . *Unit* will begin flashing.
8. Press  to select lb or kg, when the LED is lit by the correct unit, press . *CAP* displays.
9. Press . A capacity of 10000 is the initial value and should not be set any higher than the load cell rated capacity.

10. Press  to scroll through the numbers and press  to set the number.
11. With the correct number displayed, press . d displays.
12. Press . The current scale divisions will display.
13. Press  to scroll through the available scale divisions.
14. When the desired value displays, press . $U_{nL}d$ displays, follow the standard calibration procedure in Section 5.2 on page 17 (starting with step 2) to complete calibration.

5.4 Guidelines for Capacity and Resolution

Crane scales are subject to forces that regular floor scales do not see. Bridge cranes, hoist cranes and mobile cranes lack rigidity and tend to bounce or swing when loads are lifted. Rice Lake Weighing Systems recommends that resolution is kept in the 1:2000 to 1:3000 range. Some improvement in stability can be achieved by increasing the filtering. If the *MSI-3460* display is unstable, it is recommended that the resolution be reduced and/or filtering increased.

Due to Legal for Trade requirements and general scale design criteria, the weight must be stable for **ZERO**, **TARE** and **TOTAL** to work.

To improve stability:

- Increase the filtering, at the risk of increasing settling time
- Increase the d (reduce resolution)
- Increase the motion window



Note

The MSI-3460 defaults to $\pm 1d$ as a motion window. It can be changed at Rice Lake Weighing Systems to a higher value if desired. Often $\pm 3d$ is selected for bridge cranes as these tend to have a lot of bounce to them. This will carry an accuracy penalty, adding $\pm 3d$ to the total accuracy of the scale, if the zero or tare operation happens to capture the weight in a valley or peak.

Setting capacity is dictated primarily by the capability of the load cell. Many different capacities of the *MSI-3460* are offered.



WARNING

Never set the capacity of the scale higher than the rating of the load cell.

Due to excellent linearity of the MSI S-Beam load cell, it is acceptable to set lower capacities to better match the crane that the *MSI-3460* is used on.

Example: if the hoist is rated for 9000 lb, then use a 10000 lb weight and reset the capacity to 9000 lb.

Use the Initial Calibration procedure for this calibration. De-rating as much as 50% of the capacity is usually acceptable, but the scale may be less stable if the d is decreased.

Due to kg to lb conversions, the capacity of all *MSI-3460* systems is rated approximately 20% higher than the rated capacity in pounds. This is to allow the kg capacity to be exactly 1/2 the number of the pound capacity.

5.5 Constant Calibration (C-Cal)

When adequate test weights are not available, the *MSI-3460* can be calibrated using a programmed constant calibration which is referred to as C-Cal. To use the C-Cal number must be known from a previous calibration. Rice Lake supplies replacement load cells for the *MSI-3460* with the C-Cal value stamped on the serial number label. When a calibration is performed with test weights, a new C-Cal is generated. C-Cal can be used when the electronics are replaced to get an approximate calibration is suitable for non Legal for Trade applications.













Important

The C-Cal number must be known prior to starting this procedure. For a MSI-3460 with its original load cell, Rice Lake prints this number on the calibration record, the serial number tag and on the calibration log found inside the battery compartment.

C-Cal can slightly reduce the absolute accuracy of the system if the electronics are replaced or a new load cell is installed and is intended for non-critical use only. Legal for Trade installations require that the *MSI-3460* is calibrated using test weights. If a system was originally multi-point calibrated, the C-CAL calibration will erase the additional span points, as C-Cal is only a two point calibration (zero and span at 10% of capacity).

Use the following steps to perform a C-Calibration.



1. Place the *MSI-3460* into calibration mode. See Section 5.1 on page 17.
2. Press  to scroll to \bar{C} -CAL.
3. Press . *UnLd* displays, ensure all weight has been removed from the scale.
4. Press  to set the zero calibration point. A flashing $\bar{0}$ displays. If the zero is in range, the scale will display *PASS*, then displays \bar{C} -CAL.
5. Press . A flashing $\bar{0}$ displays.
6. Press  to enter the C-Cal value. The far left digit will flash indicating that number should be entered.
7. Press  to scroll the numbers and  to enter each digit.
8. When correct number is displayed, press  to save. The display will read *PASS* followed by \bar{C} AL d.
9. Press  to exit C-Cal setup menu.
10. Press  to store the calibration and return to the weigh mode. *StorE* will display briefly.





5.6 Standard Menu

Selection	Description
Industrial (<i>indUS</i>)	This is the most common setting for the <i>MSI-3460</i> . With the Industrial standard, there is full range zero, access to units switching, filters, and peak hold.
Handbook 44 (<i>Hb-44</i>)	Enables only approved features per the NTEP HB-44 rules and regulations. Access is denied to Peak Hold, and the zero range may be limited. The Filter menu is moved to the calibration setup menu, so filters are only accessible through the calibration seal
R-76 (<i>r-76</i>)	Sets the scale to enable only approved features per OIML R-76. Only kg weight units are available. The zero range is limited to 4% (-1 to +3% relative to calibrate zero). Net/Gross function is temporary. Once net weight is established, pushing an F key set for Net/Gross will cause a maximum 5 second display of the gross weight. Clear the Tare to display gross weight constantly. Other metrological aspects are changed to meet R-76 requirements.
1Unit (<i>1Unit</i>)	The 1unit standard is exactly the same as Industrial, except units switching is inhibited. This is useful for metric only countries. Another use of the 1Unit standard is to allow the scale to be calibrated in units other than lb or kg, since conversions are eliminated. Contact Rice Lake for more information on the standards settings.

Table 5-1. Standard Menu Selections

Use the following steps to set up standard settings.

1. Enter configuration mode. See Section 5.1 on page 17. \bar{C} AL displays.
2. Press  to scroll to *SEtUP*.
3. Press . *StAnd* displays.

4. Press . The current standard setting is displayed.
5. Press  to scroll to the desired standard.
6. Press  to set the standard.
7. Press . *AUTOCAL* is displayed.
8. Press  twice to exit setup and store all changes. *STORE* is displayed briefly, then the unit goes to the weigh mode.







5.7 Auto Zero Maintenance (AZM)

An auto zeroing maintenance mechanism is used to adjust the zero reading to the center-of-zero. The center-of-zero is defined as the weight reading within 1/4 d of zero. AZM continuously adjusts zero to maintain the center-of-zero. It is recommended that AZM is on to maintain the highest accuracy.

There are circumstances when it should be turned off. This can happen when minor variations of weight occur while picking up scale attachments and the variations fall within the AZM capture window. The AZM capture window (usually 1 d) and capture time (usually 8 seconds) can be adjusted by Rice Lake Weighing Systems to meet custom requirements.



The settings of AZM are dictated in Legal for Trade standards and cannot be adjusted.





Use the following steps to set up a Legal for Trade standard settings.

1. Enter configuration mode. See Section 5.1 on page 17. *CAL* displays.
2. Press  to scroll to *SEtUP*.
3. Press . *StAnd* displays.
4. Press  to scroll to *AUTO0*.
5. Press . The current setting is displayed.
6. Press  to toggle between *On* or *OFF*.
7. Press . *0. P-UP* displays.
8. Press  twice to save settings. *STORE* displays briefly and exits setup.

5.8 Zero Power Up (0.P-UP)







This feature will cause the unit to automatically zero after the unit is turned on. Default is *OFF*.

1. Enter configuration mode. See Section 5.1 on page 17. *CAL* displays.
2. Press  to scroll to *SEtUP*.
3. Press . *StAnd* displays.
4. Press  to scroll to *0. P-UP*.

5. Press . The current setting is displayed.
6. Press  to toggle between *On* or *OFF*.
7. When desired value is displayed, press . *FILTER* displays.
8. Press  twice to save settings. *STORE* displays briefly and exits setup.

5.9 Filter

Changing the filter settings allows the scale to adjust to situations where there is a lot a movement in the structure. If the reading is not stable, it can often be improved by increasing the filter setting. Settling time will be longer as the filter setting is increased. However, the *MSI-3460* employs algorithms that speed up large weight changes while still controlling vibration even with high filter settings. Selections are *OFF*, *LD* and *High*.

1. Enter configuration mode. See Section 5.1 on page 17. *CRN* displays.
2. Press  to scroll to *SEETUP*.
3. Press . *Stand* displays.
4. Press  to scroll to *FILTER*.
5. Press . The current setting is displayed.
6. Press  to scroll to desired setting.
7. When desired value is displayed, press . *Stand* displays.
8. Press  twice to save settings. *STORE* displays briefly and exits setup.

6.0 Communications

The *MSI-3460* can communicate with peripheral devices using RS-232, 802.15.4, or 802.11/b, g, n Wi-Fi. Only one communication type can exist at a time. Due to the difficulty of dangling RS-232 cables from a hanging crane scale, the RF options are more commonly used for gathering weight data.

The RS-232 port located on the right side of the *MSI-3460* is useful for setup and calibration using a computer and the ScaleCore Connect software available on the Rice Lake website.

For RF operation, the *MSI-3460* uses an 802.15.4 transceiver to communicate between the MSI-8000 RF remote display. 802.15.4 operates in the 2.4 GHz ISM band and does not require the end user to obtain a license. 802.15.4 can coexist with other 2.4 GHz systems if caution is taken to isolate antennas at least 10' (3 m) from the crane scales and MSI-8000 Remote Display acts as the network coordinator. Also available is the 802.11 Wi-Fi option for communicating directly to a standard RF access point.

6.1 Printer / Serial Output Setup

The RS-232 communications port is capable of outputting load data. All of the RF linked device weight modes are available in user formatted form.

The communications port settings are independent of any print settings in connected displays/indicators. They reside only in the *MSI-3460*.

Parameters	Choices	Description
Listen	--	Listen – connects with an RF remote.
Output-P	Port. 0 RF	Output Port – select output port for print
SerialString	--	Serial String – for use in printing, see Section 6.1.1 on page 23.
Control	USER Load CONTINUOUS OFF	Control – print mode selected, see Section 6.1.2 on page 24.
Rate	0-65535	Rate – output rate in seconds, 0 is the fastest possible setting.

Table 6-1. Print Parameters

6.1.1 Standard Print Strings

Commands that can be used to format gross, net and print formats are shown below.

Command	Description
<T>	Load data
<U>	Units
<M>	Load mode (lb/kg)
<CRLF>	Carriage return line feed
<SP>	Space

Table 6-2. Standard Print Strings Commands

1	Current load	Fixed output length: 16. Leading zeros suppressed except for the least significant digit (LSD). <TTTTTT><SP><UU><SP><MMMMM><CRLF>
2	Net load	Fixed output length:16. Leading zeros suppressed except for the LSD. <TTTTTT><SP><UU><SP>NET<SP><SP><CRLF>
3	Gross load	Fixed output length: 16. Leading zeros suppressed except for the LSD. <TTTTTT><SP><UU><SP>GROSS<CRLF>
4	Tare Weight	Fixed output length:16. Leading zeros suppressed except for the LSD. <TTTTTT><SP><UU><SP>TARE<CRLF>

Table 6-3. Standard Print Strings

5	Total Weight	Fixed output length: 16. Leading zeros suppressed except for the LSD. <TTTTTT><SP><UU><SP>TTL<CRLF>
6	Number of Samples Totaled	Fixed output length: 16. Leading zeros suppressed except for the LSD. <SP><SP><SP><SP><SP><SP><SSSSSS><SP><T-CNT><SP>CRLF>
7	Current Weight Mode	Net, Gross, Peak, etc <SP><MMMM>CRLF>
8/9	Carriage Return/ Line Feed	Used to add a space between print records. <CRLF>

Table 6-3. Standard Print Strings (Continued)

Combinations of the standard print strings can be entered in the string number entry screen.

Example: To get a NET, GROSS, TARE printout with a space between records, enter 2349.

The ScaleCore Connect software can also be used for custom output strings. It can be downloaded from www.ricelake.com.

The serial output is configured as 9600 baud, Xon/Xoff handshaking, no hardware handshaking, 1 stop bit, no parity. Other baud rates are possible by special order only.

6.1.2 Control Modes

The user can select three control modes which are described in Table 6-4.

























Mode	Description
User	Printing is controlled by the operator using  . If set to print mode. If using a remote device, there may be a dedicated PRINT key (F-key 3) available.
Load	One print occurs when a stable load is read. The scale must then return to near zero before another print will occur.  Note <i>Other configurations of loads are available using the ScaleCore Connect software. It can be downloaded from www.ricelake.com</i>
Continuous	The MSI-3460 will continuously output the data at a rate specified in the rate parameter (up to 65,535 seconds). Setting the interval to 0 will set an interval as fast as the system can go.
Off	Printing is disabled. Power consumption is lower with the print off.

Table 6-4. Control Modes

6.1.3 Printer Output Setup

Use the following steps to set up the printer output.

- Press  and  at the same time. *Pr int* is displayed.
- Press . *L iStn* is displayed.
- Press . The current setting flashes.
- Enter the number using  to scroll through numbers and  to set number.
- Press . *OUT-P* displays.
- Press . The current setting flashes.
- Use  to toggle between *Port0* and *rF*.
- When the desired setting is displayed, press . *Stn0* displays.

9. Press  to enter.
10. Enter the number using  to scroll through numbers and  to set the string number desired.
11. When set, press  again. `cntrl` displays.
12. Press  to enter. Current setting flashes.
13. Press  to scroll through the settings.
14. When desired setting is displayed, press . `rflE` displays.
15. Press  to enter.
16. Enter the number using  to scroll through numbers and  to set number.
17. Press  again. `LSLEN` displays.
18. Press  twice to save settings. `StorE` displays briefly and exits setup.



Note When entering numbers, pressing  will step back a digit for corrections.

6.2 RF Network Setup

The *MSI-3460* uses 802.15.4 transceivers to communicate with an *MSI-8000* remote display.

The *MSI-3460* uses three numbers to establish a piconet. A piconet is a network that is created using a wireless connection. Table 6-5 lists out the elements used in setting up a piconet.

6.2.1 802.15.4 RF Network Setup

When equipped with the 802.15.4 option, the *MSI-3460* can connect with an *MSI-8000* Remote Display or another supported device with an 802.15.4 Modem.





Choices	Parameters/ Range	Description
<code>On. OFF</code>	On OFF	Enable RF – affects continuous mode only.
<code>Sc id</code>	0-254 20-30 recommended	ScaleCore ID – used to identify each ScaleCore device in a Piconet, must not be duplicated within the same RF Channel  Note <i>When using the MSI-8000 as network coordinator, it is recommended to use a number for the MSI-3460 from 0-3 if multiple units will be connected to the MSI-8000. If a single MSI-3460 is used, then any number up to 254 is acceptable.</i>
<code>chnl</code>	12-23	RF Channel – establishes the base network that all interconnected devices must match, range 12-23
<code>net id</code>	0-99999	Network ID – a 64 bit number that all interconnected devices must match. The <i>MSI-3460</i> limits this number to a max of 5 digits in a range of 0-99999.  Note <i>Do not use a small number here to help avoid other 802.15.4 networks that default to a Network ID of 0 Range 0-99999</i>
<code>TYPE</code>	ZBEE Other	Connection Type – type of card being used
<code>Hold</code>	On OFF	--





















Table 6-5. RF Menu Parameters

To enter the menu:

1. Press the  and  keys at the same time. *Prnt* displays.



Note *busy* may flash momentarily before entering the communications menu.

2. Press . *rF* displays.
3. Press . *On. OFF* displays.
4. Press  to scroll through parameters.
5. Press  to enter parameter. The current value flashes.
6. With parameter displayed, press  to select. The currently selected parameter flashes.
7. Press  to scroll through settings.
8. Press . *Sc id* is displayed.
9. Press . The current ID flashes. If SCID is correct, skip to step 11.
10. Enter the ID using  to scroll through numbers and  to set number.
11. When ID is set, press  again. *Chnl* displays.
12. Press . The current channel flashes. If the channel number is correct skip to step 14.
13. Enter the channel using  to scroll through numbers and  to set number.
14. When channel is set, press  again. *Net id* displays.
15. Press . The current net ID flashes. If the net ID is correct, skip to step 16
16. Enter the network id using  to scroll through numbers and  to set number.
17. When the Net ID is set, press  again. *On. OFF* displays.
18. Press  twice to save and exit to weighing mode.



Note When entering numbers, pressing  will step back a digit for corrections.

6.2.2 FCC Statement (for 802.15.4 Option)

Contains FCC ID: OUR-XBEEPRO

The enclosed device complies with Part 15 of the FCC rules. Operation is subject to the following two conditions: (i.) this device may not cause harmful interference and (ii.) this device must accept any interference received, including interference that may cause undesired operation.

6.2.3 International RF CERTS (For 802.15.4 OPTION)

Canada Radio Cert. No.: IC: 4214A-XBEEPRO

Australia & New Zealand: AS4268:3000

Japan: Certificate of Radio Equipment in Japan No.: 08215111/AA/02

Europe and much of Asia:

This product is compliant with the following standards and/or other normative documents:

Safety (article 3.1A) EN60950-1:2001

EMC (article 3.1b) ETSI EN 301 489-17 v1.2.1 (2002-08)

Spectrum (article 3.2) ETSI EN 300 328 v1.7.1 (2006-10)

7.0 Maintenance and Troubleshooting

7.1 Troubleshooting

Problem	Possible Cause	Solution
Display is blank when  pressed	Discharged battery	Recharge, allow at least four hours charge
	Defective battery	Replace
	Corroded battery or battery contacts	Clean contacts
	Defective switch or circuit board	Requires authorized service
Display does not function properly or front panel keys do not function normally or scale will not turn off	Improperly updated software.	Reinstall software
	Faulty circuit board	Requires authorized service
	Loose connectors	Requires authorized service
Scale does not respond to weight changes	Out of calibration	Calibrate
	Faulty load cell	Replace
	Load cell connector	Check connector and wires
Display over ranges below 100% capacity	Tared weight is added to load to determine overload point	Return to gross weight mode
	Zero requires adjustment	Rezero the scale
	Too much weight has been zeroed	Rezero the scale
Display Drifts	AZM (Auto0) is turned off	Turn AZM on
	Rapid temperature changes such as moving the scale from indoors to outdoors	Wait until the scale temperature has stabilized
Displayed weight shows large error	Scale not zeroed before load is lifted	Zero the scale with no load attached
	lb/kg units causing confusion	Select proper units
	Requires recalibration	Recalibrate
Display reading not stable	Excessive vibration in crane system	Increase filtering or increase d in cal
	Excessive side loading	Improve load train symmetry
	Load cell faulty	Check LC connections
Display toggles between ERROR and LOAD	Weight exceeds capacity	Reduce weight immediately
	Faulty load cell or wiring	Check LC and LC wiring
Display toggles between ERROR and A2DLO	A/D is saturated negative	Check LC and LC wiring
Display toggles between ERROR and BUTTN	A key is stuck or is being held down	Check switches for damage
		Ensure that a remote is not transmitting continuously
RF remote does not work	Units not mated	See Setting the Transmitter (Section 5.1.3) and Receiver (Section 5.1.4) address procedures
Some RF remote keys do not work but the ACK light blinks	Keys were not enabled during the setup process	Enable keys by running the transmitter and receiver address procedures
Lo Batt is blinking	Battery is low	Recharge battery
Unit turns on, then immediately off	Battery is low	Recharge battery
Weight will not zero	System not stable	Wait for motion light to turn off
		Increase filtering for more stability
Weight will not tare or total	Zero out of range	LFT units have limited zero range. Reduce the weight or use tare instead
		System is not stable
Weight will not tare or total	System is not stable	Wait for motion light to turn off, or if in a mechanically noisy crane, increase the filtering or reduce the size of the scale increment d . The motion window can also be increased. Contact RLW if there is a problem getting the MSI-3460 to zero, tare, or total due to stability issues
		Setpoint lights blink
Setpoint lights blink	Setpoint is enabled and the trigger point has been reached	Disable setpoints if they are not needed
		Manual total does not work
Manual total does not work	A function key is not set to TOTAL	Set up FUNC1 or FUNC2 for TOTAL
	Weight must be stable	Increase filtering for more stability

Table 7-1. Troubleshooting

Problem	Possible Cause	Solution
Auto total does not work	Weight must be stable	Wait for the motion light to go out, or increase filtering for more stability
	Weight thresholds not reached	Weight thresholds must exceed 1% of capacity for autototal to work. Then it must drop below 0.5% of capacity for additional weighments to register.

Table 7-1. Troubleshooting (Continued)

7.2 Service Counters





WARNING Only a MSI factory representative can reset the service counters, as these are important safety warning features. Depending on the circumstances, a thorough load train inspection might be necessary to ensure user safety.

Reference MSI's "Crane Scale Safety and Periodic Maintenance manual" (Pub. 243-08-94D) for proper loading techniques to improve the safety and longevity of your MSI-3460 crane scale. This publication is available at www.msiscales.com and is included in the CD shipped with your crane scale.

The MSI-3460 maintains two service counters for safety.

- The first counter counts the number of times the scale has been overloaded.
- The second counter counts lifts above 25% of capacity.





These counters serve to warn the user to inspect the load train after a number of overloads, also when there is a chance of fatigue failure. The power up routine will be interrupted when the lift counter exceeds 16383 lifts or the overload counter exceeds 1023 overloads. If the screen displays *LFCNT* when unit is powered on:

1. Press  to display the 25% lift counter.
TARE
2. Press  again to see the overload lift counter.
TARE
3. Press  to acknowledge the warning and return to standard scale operation.
ZERO







Note The power up warning message won't appear again for another 16383 lifts (or 1023 overloads).

To access the service counters:

4. Program  to be *TEST*. See Section 4.1 on page 10.
USER
5. Press .
USER
6. Within two seconds of pressing , press . The display flashes *LFCNT* (for Lift Counter) followed by the number of times the weight has exceeded 25% of capacity.



Note Press  to step through the service counters.
TARE

7. Press . The display flashes *OLCNT* (for Overload Counter) followed by the number of times the weight has exceeded capacity.
USER
8. Press . The display flashes *C-CAL* followed by the C-Cal value.
USER
9. Press . Returns to standard weighing mode.
USER

7.3 Software Update

For use with ScaleCore3 Printed Circuit Assembly (Circuit Board)

Equipment Requirements:

- PC with terminal program
- Interface Cable PN: 503230-0001 (10') or -0002 (5')

Updating Process

1. Connect interface cable to P2, as shown.

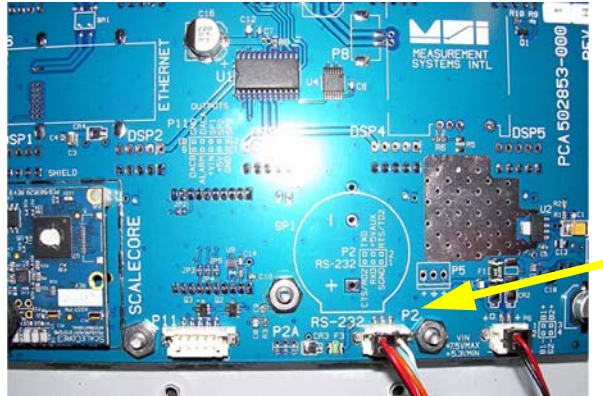

Figure 7-1. Connecting Interface Cable

2. Power on the scale.
3. Open the terminal program.

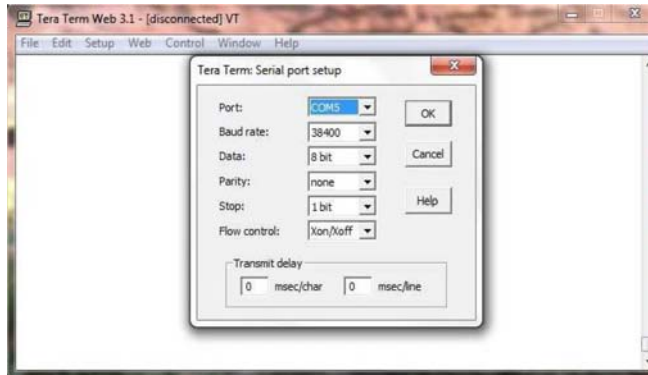
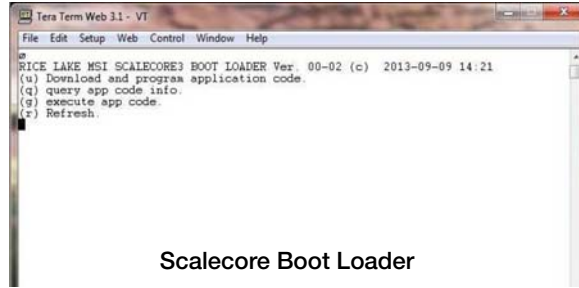

Figure 7-2. Serial Port Setup

4. Configure to the following:
 - Baud Rate: 38400
 - Data Bits: 8
 - Parity: None
 - Stop Bits: 1
 - Flow Control: XON/XOFF
5. Type: {00FF09=0199}, then press **Enter**. This command accesses the boot-loader program within the SCALECORE. *BLOAD* displays on the MSI-3460 and the Scalecore Boot Loader menu appears on the terminal screen.



MSI-3460 Display



Scalecore Boot Loader

Figure 7-3. Access Bootloader From Scalecore

6. Type **u** to download and program the application code. The boot loader program prompts to send the file.
7. Select the file, then send. Wait for a complete file transfer.

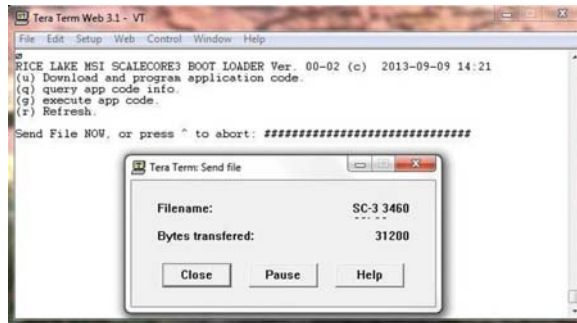

Figure 7-4. Send File

When complete, the boot loader menu appears on terminal screen.

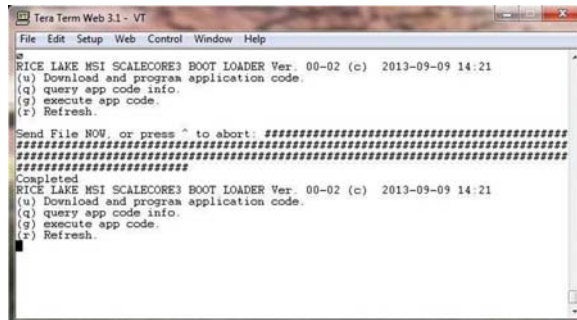

Figure 7-5. Bootloader Menu

8. Verify the Application Code Version, type **q** to query app code info.
 - App Code Version: 03b03



Note Contact Rice Lake Weighing Systems for the current version.

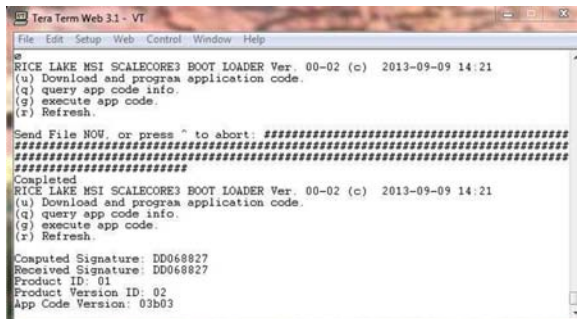

Figure 7-6. Query App Code Info

9. Type **g** to execute the application code, the MSI-3460 display will return to normal weighing mode.



Figure 7-7. Normal Weighing Mode

7.4 MSI-3460 Challenger 3 Dimensions

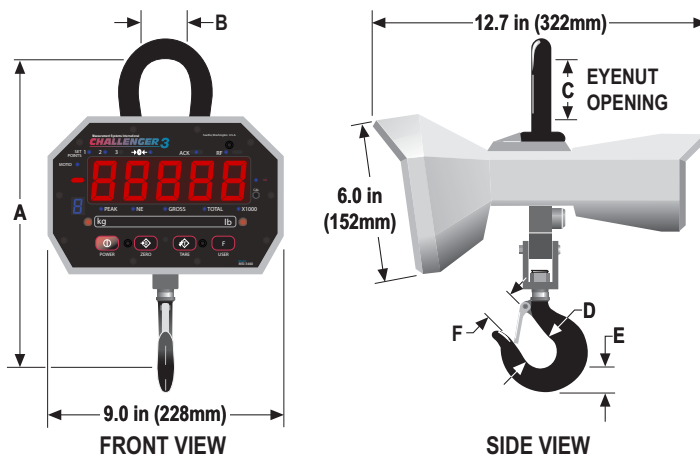

Note 15,000 lb (7,000 kg) unit comes standard with 12 ton top

Capacity	Resolution	A	B	C	D	E	F	Approximate Shipping Weight
250 lb	0.1 lb	11.94 in	2.0 in	2.45 in	1.63 in	1.14 in	1.16 in	22 lb
125 kg	.05 kg	303 mm	51 mm	62 mm	41 mm	29 mm	29 mm	10 kg
500 lb	0.2 lb	11.94 in	2.0 in	2.45 in	1.63 in	1.14 in	1.16 in	22 lb
250 kg	0.1 kg	303 mm	51 mm	62 mm	41 mm	29 mm	29 mm	10 kg
1,000 lb	0.5 lb	11.94 in	2.0 in	2.45 in	1.63 in	1.14 in	1.16 in	22 lb
500 kg	0.2 kg	303 mm	51 mm	62 mm	41 mm	29 mm	29 mm	10 kg
2,000 lb	1.0 lb	11.94 in	2.0 in	2.45 in	1.63 in	1.14 in	1.16 in	22 lb
1,000 kg	0.5 kg	303 mm	51 mm	62 mm	41 mm	29 mm	29 mm	10 kg
5,000 lb	2.0 lb	16.67 in	2.45 in	3.40 in	2.5 in	1.81 in	1.61 in	39 lb
2,500 kg	1.0 kg	423 mm	62 mm	86 mm	64 mm	46 mm	41 mm	18 kg
10,000 lb	5.0 lb	16.67 in	2.45 in	3.40 in	2.5 in	1.81 in	1.61 in	39 lb
5,000 kg	2.0 kg	423 mm	62 mm	86 mm	64 mm	46 mm	41 mm	18 kg
15,000 lb	5.0 lb	16.67 in	2.45 in	3.40 in	2.5 in	1.81 in	1.61 in	39 lb
7,500 kg	2.0 kg	423 mm	62 mm	86 mm	64 mm	46 mm	41 mm	18 kg

Table 7-2. MSI-3460 Challenger 3 Dimensions

7.5 Specifications

Accuracy	$\pm(0.1\% + 1d)$. d equals one displayable increment.
Resolution	Standard displayed resolution: 2500-3750 d. Resolutions to 10000 d (non LFT units only) are possible. Internal A/D resolution 24 bits.
Standard Capacities	lb – 250, 500, 1000, 2000, 5000, 10,000, 15,000 kg – 125, 250, 500, 1000, 2500, 5000, 7500
Power	Battery operated, 6V rechargeable sealed-lead acid battery pack (standard Challenger Charger) Typically 50 hours of battery life with automatic sleep mode and automatic power off.
Display	Five-digit, large 1.5 in (38 mm) numeric red GaAlAs Light Emitting Diode (LED)
Operating Temp	-40°F to +122°F (-40°C to +50°C), LFT range - 10°F to +104°F (10°C to +40°C)
Operating Time	50 hours typical/100 hours max. (depends on operating mode)
Enclosure	NEMA Type 4/IP65 powder coated anodized cast aluminum
Load Cell	Standard 350 Ω Bridge, S-Beam
User	Programmable multifunction button for use as Test, Total, Unit, Peak, Net/Gross, View Total, Learn (for RF Remote Control), Hi-Res
CAL	Front panel calibration switch (located behind wire sealable screw) initiates full digital calibration procedure.
Auto Zero Maintenance	Standard, can be disabled internally
Auto-Off Mode	Prolongs battery life by turning POWER off after 15, 30, 45 or 60 minutes (operator determined) of no scale activity.
Auto-Sleep Mode	Prolongs battery life by dimming LED display after 5, 15, or 30 minutes of no activity.
Units	kg, lb (other units available with custom calibrations)
Filtering	Selectable: OFF, Low (LO), Medium (HI-1), High (HI-2)
Totalization	Standard: Press button or automatic; TOTAL weight up to 99999 X 1000 kg or lb.
Peak	Uses unfiltered faster reading of A/D, (>220 readings per second)
Setpoints	Three internal standard setpoints and three ultra bright LEDs on front panel.
Service Counter	Two independent 32 bit registers; register 1 updated each time weight exceeds 25% of capacity; register 2 updated each time weight exceeds overload; when register 1 exceeds 16383 or register 2 exceeds 1023, display reads <i>CNT</i> for load cell counter; Test function shows the two readings in order.
Construction	All of these features are housed in a single, low-profile, cast aluminum housing consisting of three sections: The front of the scale houses the display, controls and all electronics. The center section contains the load cell, lifting eye and hook. The rear of the scale features a quick-access battery compartment.
Options	Wireless Remote Controller 50' (15 m) typical range Light-of-Sight. Uses 418 MHz (USA) hand-held transmitter. 802.15.4 RF Modem for connectivity with MSI-8000 RF Remote Display Integral 802.15.4 RF Modem for connectivity to Optional MSI-8000 RF Remote Display. MSI-8000 RF Remote Display 100' (30 m) typical range line of sight. Uses 802.15.4, 2.4 GHz transceiver



The MSI-3460 scale has a safe mechanical overload of 200%, and an ultimate overload of 500%. Overloads greater than 500% may result in structural failure and dropped loads. Dropped loads may cause serious personal injury or death.



© Rice Lake Weighing Systems Specifications subject to change without notice.
Rice Lake Weighing Systems is an ISO 9001 registered company.

230 W. Coleman St. • Rice Lake, WI 54868 • USA
U.S. 800-472-6703 • Canada/Mexico 800-321-6703 • International 715-234-9171 • Europe +31 (0)26 472 1319

www.ricelake.com