



EJ-123

Compact Precision Balance

INSTRUCTION MANUAL

This Manual and Marks

All safety messages are identified by the following, "WARNING" or "CAUTION", of ANSI Z535.4 (American National Standard Institute: Product Safety Signs and Labels). The meanings are as follows:

 WARNING	A potentially hazardous situation, which if not avoided, could result in death or serious injury.
 CAUTION	A potentially hazardous situation, which if not avoided, may result in minor or moderate injury.



This is a hazard alert mark.

Note This manual is subject to change without notice at any time to improve the product. No part of this manual may be photocopied, reproduced, or translated into another language without the prior written consent of the A&D Company.

Product specifications are subject to change without any obligation on the part of the manufacturer.

Compliance with FCC rules

Please note that this equipment generates, uses and can radiate radio frequency energy. This equipment has been tested and has been found to comply with the limits of a Class A computing device pursuant to Subpart J of Part 15 of FCC rules. These rules are designed to provide reasonable protection against interference when the equipment is operated in a commercial environment. If this unit is operated in a residential area it may cause some interference and under these circumstances the user would be required to take, at his own expense, whatever measures are necessary to eliminate the interference.

(FCC = Federal Communications Commission in the U.S.A.)

Copyright©2013 A&D Company, Limited

Microsoft, Excel and Word are trademarks of Microsoft Corporation.

CONTENTS

1. INTRODUCTION	3
2. UNPACKING.....	3
3. PART NAMES AND FUNCTIONS	4
4. SETTING UP	5
4.1. Setting Up Your Balance.....	5
4.2. Power Source	6
4.3. Breeze Break	7
5. OPERATION.....	8
5.1. Turn The Power ON And OFF.....	8
5.2. LCD Backlight	8
5.3. Units	9
5.4. Selecting A Weighing Unit.....	9
5.5. Basic Operation	10
5.6. Display Hold Mode.....	10
5.7. Counting Mode (pcs)	11
5.8. Percent Mode (%).....	12
6. ACCUMULATION FUNCTION.....	13
7. CALIBRATION	15
7.1. Calibration Using A Weight	15
7.2. Gravity Acceleration Correction	16
8. FUNCTIONS.....	17
8.1. Key Operation	17
8.2. Entering The Function Setting Mode.....	17
8.3. Setting Example.....	18
8.4. Storing Weighing Units	19
8.5. Function List.....	20
9. OPTIONS.....	22
9.1. EJ-02 USB Interface	22
9.2. EJ-03 RS-232C Serial Interface	23
9.3. Data Format	24
9.4. EJ-13 Density Determination Kit	26
10. ID NUMBER AND GLP	29
10.1. Setting The ID Number.....	29
10.2. GLP Report.....	30
11. MAINTENANCE	34
11.1. Notes On Maintenance	34
11.2. Error Codes	34

12. SPECIFICATIONS	36
12.1. Generals	36
12.2. Weighing Units.....	36
12.3. Options	37
12.4. Dimensions.....	37
13. GRAVITY ACCELERATION MAP	38

1. INTRODUCTION

This manual describes how this balance works and how to get the most out of it in terms of performance.

The EJ-123 compact precision balance has the following features:

- ❑ The balance is high-resolution type electronic balance having a display resolution of 1/120,000.
- ❑ The balance has a counting function, a percent function, a hold function and a total function.
- ❑ The LCD backlight will help with use in a dimly lighted place.
- ❑ The balance can be operated with an AC adapter, or 4 x “AA” size dry-cell batteries for cordless operation.
- ❑ The optional RS-232C serial interface can be connected with a printer or personal computer, and Good Laboratory Practice (GLP) data can be obtained.
- ❑ The optional USB interface is available for connection to a personal computer.

2. UNPACKING

When unpacking the product, check whether all of the following items are included and remove the protective film before use :

EJ-123

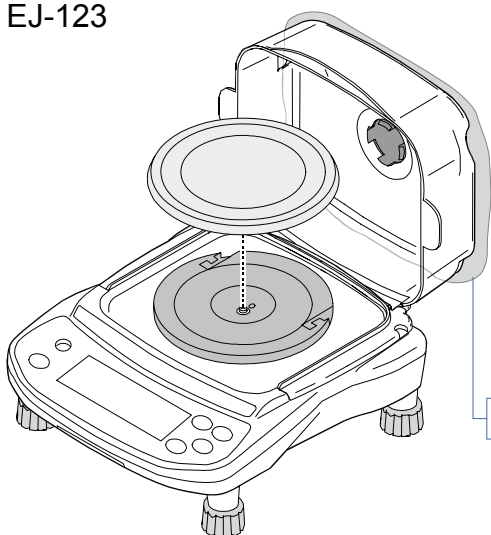

Protective film

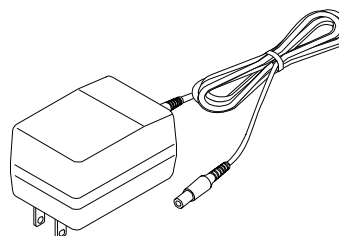



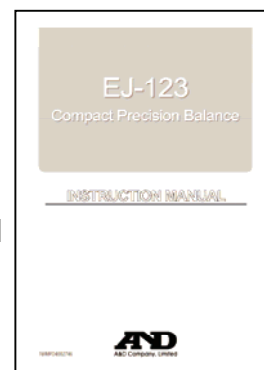

Please confirm that the AC adapter type is correct for your local voltage and receptacle type

Instruction Manual

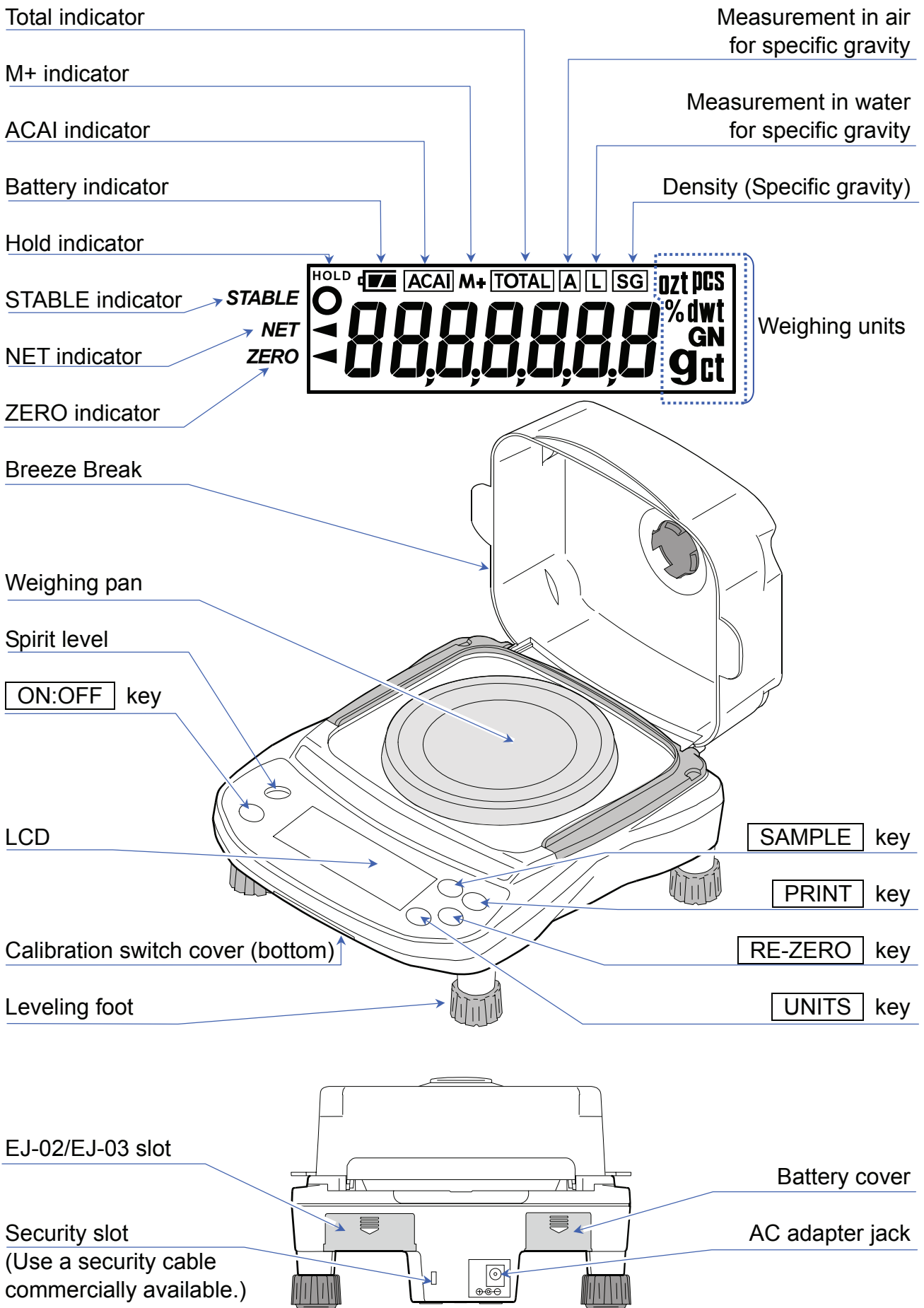

3. PART NAMES AND FUNCTIONS

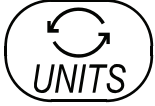

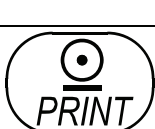
	Turns the power ON or OFF.
	Switches the weighing units and modes.
	Clears the display to zero (combined zero and tare).
	Held down to enter the function setting mode. pcs mode: Enters the sample unit weight storing mode. % mode: Enters the 100% weight storing mode. Total mode: Adds the measurement value to total.
	Outputs the weight data to a printer, or computer. Enters a unit weight, 100% weight or other setting values to the balance.

4. SETTING UP

4.1. Setting Up Your Balance

1. Place the weighing pan on the main unit.
2. Adjust the level of the balance using the leveling feet. Use the spirit level to confirm. The bubble should be in the center of the circle.
3. Calibrate your balance before use. (Refer to “7. CALIBRATION”)

Balance location

To measure correctly, to keep the balance in good condition, and to prevent hazards, observe the following:

- Do not install the balance in locations that are subject to excessive dust, breezes, vibration, large temperature fluctuations, condensation, or that may have magnetic fields.
- Do not install the balance on a surface that is soft or that may cause the balance level to shift.
- Do not install the balance in direct sunshine.
- Do not install the balance near heaters or air conditioners.
- Do not use an unstable AC power source.
- Do not install the balance in a place where combustible or corrosive gases may exist.
- Allow the balance to reach equilibrium with the ambient temperature before use.
- Switch the power ON at least half an hour before use so that the balance can warm up.
- When the balance is installed for the first time, or the balance has been moved, carry out calibration as described in “7. CALIBRATION”.

4.2. Power Source

For the power source, the AC adapter or 4 x “AA” size dry-cell batteries can be used.

When Using The AC Adapter

Use a stable power source. To use the AC adapter, insert the AC adapter plug into the AC adapter jack on the rear side of the balance.

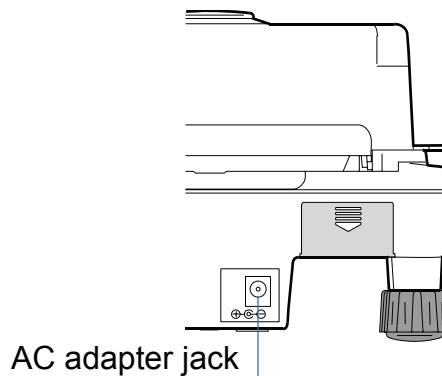

When Using The Dry-Cell Batteries

Prepare 4 x AA size (LR6 / R6P) dry cell batteries. The batteries are not included with the product.



⚠ CAUTION

- ❑ Take great care with the polarity of the batteries. The polarity marks are shown in the battery box.
- ❑ Replace used batteries with four new ones when “L bD” is displayed.
- ❑ Do not mix used and new batteries. Do not mix battery types. It may cause damage to the batteries or the balance.
- ❑ The battery life depends on the ambient temperature, how used and so on.
- ❑ Remove batteries when the balance is not to be used for a long time. They may leak and cause damage to the balance.
- ❑ Damage due to battery leakage is not covered by the warranty.

Installing Batteries

1. Turn off the balance and disconnect the AC adapter if used.
2. Slide the battery cover off.
3. Push the battery box up to unhook and pull it out.
4. Insert new four batteries (LR6 / R6P / AA size) into the battery box, taking extreme care of the polarities.
5. Push the battery box into the balance as before.
6. Attach the battery cover.

- ❑ The battery indicator turns on when the balance is powered by the batteries. It will change as the battery voltage decreases.

New  →  →  Coming close to “L bD”.

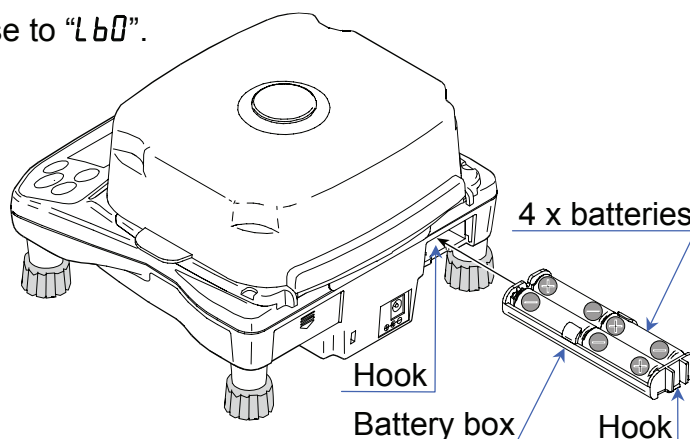
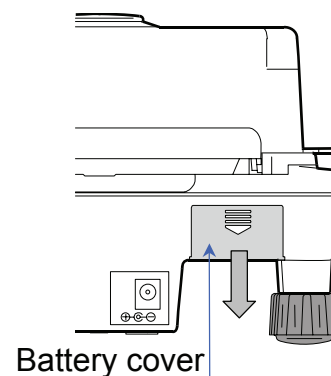

4.3. Breeze Break

The breeze break can prevent a measurement error due to a (disturbing) wind.

- ❑ Wipe it with a dry lint free cloth or a lint free cloth which is moistened with warm water.
- ❑ To keep the antistatic treatment, do not use alcohols and solvents to clean the balance.
- ❑ When an antistatic treatment becomes weak, apply an antistatic agent to the clear plastic parts.
- ❑ The clear cover can be disconnected from the fixing frame easily when adding an excessive stress during operation. Assemble the breeze break with the following steps.

Assembling the breeze break

1. Slide back the fixing frame to attach the clear cover.
(Or install the fixing frame into the guide on the balance.)
2. Attach the axis of the clear cover on the groove of the fixing frame when keeping the angle of 90 degrees.
3. Slide and fix the breeze break.
4. Close the breeze break.

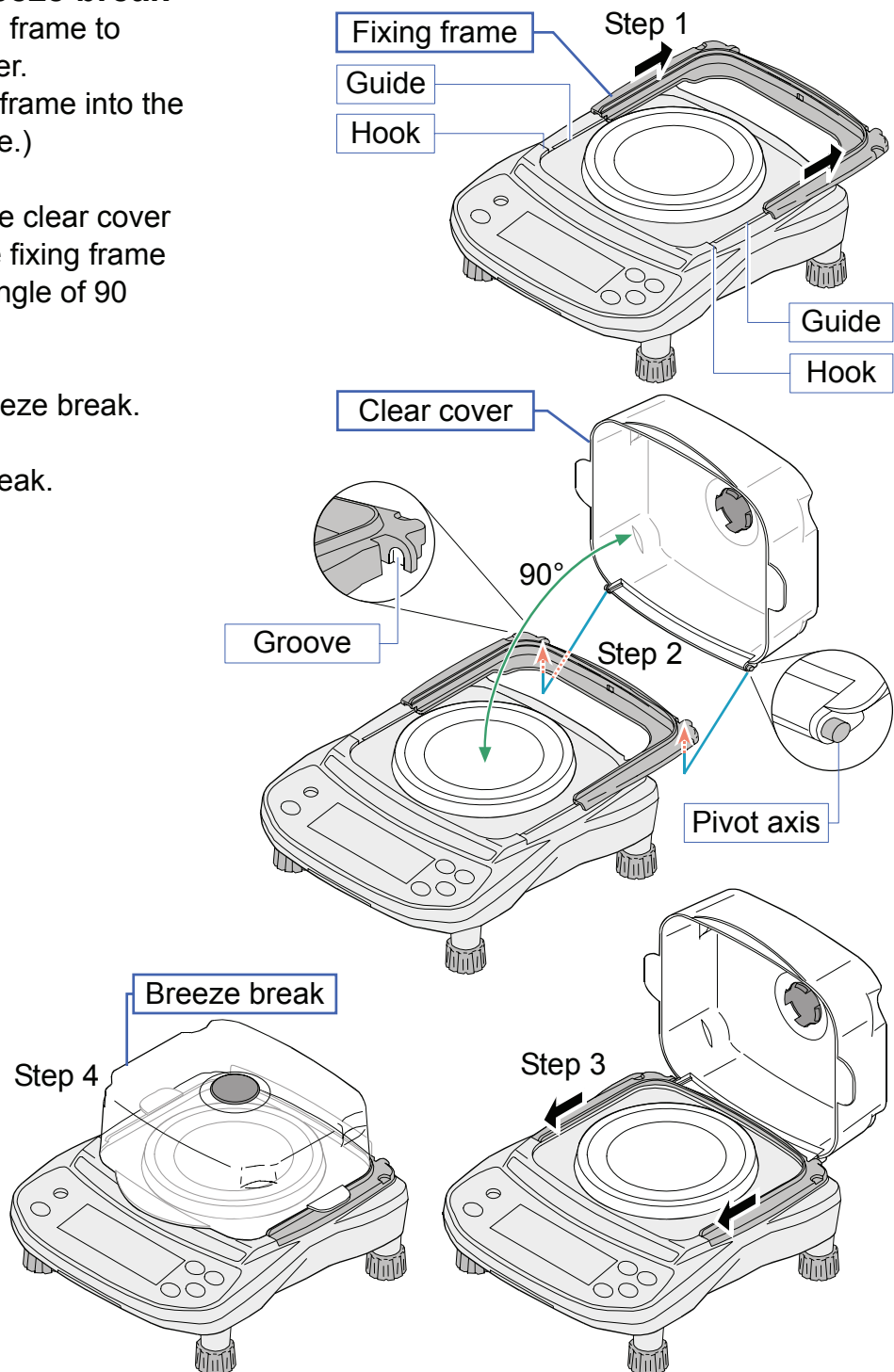

5. OPERATION

5.1. Turn The Power ON And OFF

1. Press the ON:OFF key to turn the power ON.

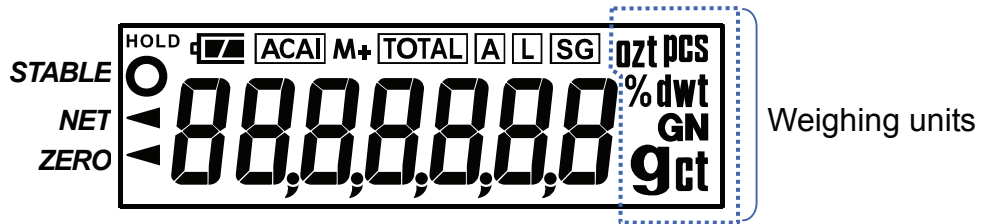

All of the symbols are displayed as shown above.
(About units: Only the available units will be displayed.)

The display turns off except for a weighing unit and the decimal point.
The balance waits for the weight value to become stable, and then, zero will be displayed with the ZERO indicator (power-on zero).

The range for power-on zero is within $\pm 50\%$ of the weighing capacity around the calibrated zero point.

If the power is switched ON while there is a load beyond this range, the balance will be tared to zero and the NET indicator and the ZERO indicator turn on.

2. Press the ON:OFF key again, and the power will be switched OFF.

□ **Auto-power off function**

It is possible to have the power automatically switched OFF, if zero is displayed for approximately 5 minutes. Refer to “8.5. Function List” and set the function to “POFF”.

5.2. LCD Backlight

The LCD backlight will turn on when the weight value changes more than 4d (4 x min. display division) or any key operation is done. When the weight value becomes and stays stable for some moments, the backlight will automatically turn off. There is also a setting that the backlight is always on or off. For details, see the function setting “LEUP” of “8.5. Function list”.

5.3. Units

The most common unit of weight used around the world is the gram, but there is often a need to shift to alternative units specific to the country where the balance is used or to select modes such as counting or percent.

The units and the order they appear in the display are as follows:

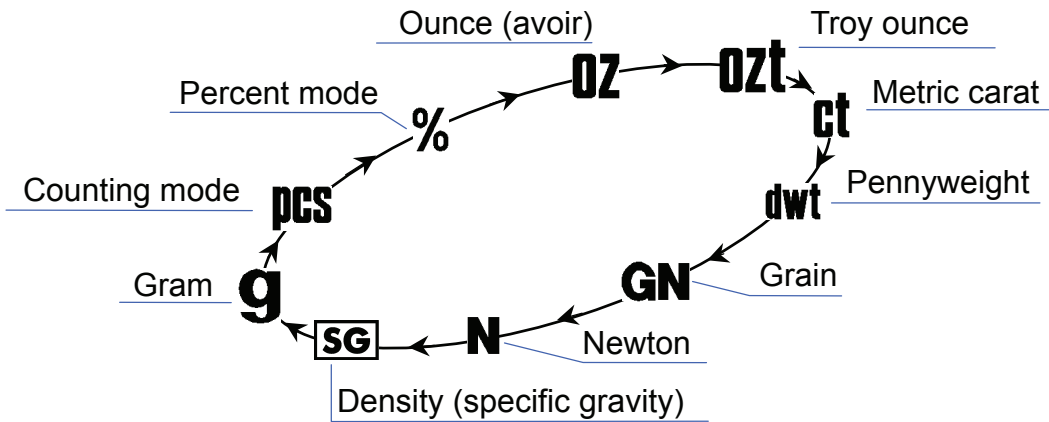

Among the units, those available for the user have been set at the factory before shipping. The unit can be selected in the function setting mode. The order of the units available is the same as above.

□ **Note**

It is possible to store only the units that will be actually used from the units available. It is also possible to specify the unit that will be shown first when the power is switched ON. For details, see “8.4. Storing weighing units”.

Conversion table

Units	Name	Conversion to gram
oz	Ounce (avoir)	28.349523125 g
ozt	Troy ounce	31.1034768 g
ct	Metric carat	0.2 g
dwt	Pennyweight	1.55517384 g
GN	Grain (UK)	0.06479891 g
N	Newton	(value in Newton) x 1000 / (9.80665 m/s ²) g

- “Newton” is the value calculated by “(weight in grams) x (9.80665 m/s²) / 1000”.

5.4. Selecting A Weighing Unit

Press the **UNITS** key to select a unit.

The following sections are a description of the three common units: g (gram mode), pcs (counting mode), and % (percent mode).



Each pressing switches the units available in the order described on the previous page.

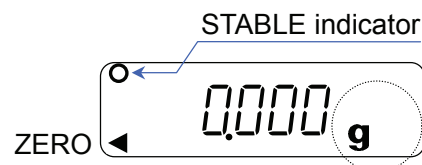

5.5. Basic Operation

1. Select a weighing unit.
2. When the display does not show zero, press the **RE-ZERO** key to set the display to zero.
3. When using a tare (container), place the container on the weighing pan, and press the **RE-ZERO** key to subtract the tare weight.
4. Place the object to be weighed on the pan or in the container.
Wait for the STABLE indicator to be displayed and read the value.
 - ❑ When using the display hold mode, the hold indicator HOLD is displayed.
5. Remove the object from the pan.
 - ❑ **The **RE-ZERO** key will zero the balance if the weight is within $\pm 2\%$ of the weighing capacity around the power-on zero point. The **ZERO** indicator \blacktriangleleft turns on. When the weight exceeds $+2\%$ of the weighing capacity, it will be subtracted from zero as a tare weight. In this case the **ZERO** and **NET** indicators turn on.**

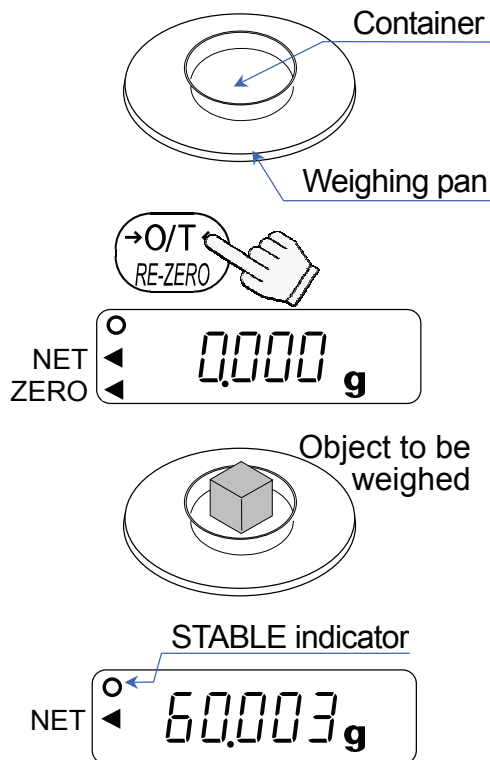

⚠ Precautions during operation

- ❑ Make sure that the **STABLE** indicator is on whenever reading or storing a value.
- ❑ Do not press the keys with a sharp object such as a pencil.
- ❑ Do not apply a shock or a load to the pan that is beyond the weighing capacity.
- ❑ Keep the balance free from foreign objects such as dust or liquid.
- ❑ Calibrate the balance periodically to maintain weighing accuracy. (Refer to "7. CALIBRATION".)

5.6. Display Hold Mode

In stable measurement, this function can pause the measurement value to read it easily. The function pauses the value except zero band. (band width : ± 4 digit from the zero point) The function releases the value when measurement value changes above preset value. Refer to the item "Hold" of "8.5. Function List".

5.7. Counting Mode (pcs)

The balance weighs the sample pieces and calculates the unit weight.

Using the sample unit weight, the scale counts the number of items in the sample.

- As for the minimum unit weight acceptable, see the function setting “ $\bar{u}n$ in”.

Selecting The Counting Mode

- Press the **UNITS** key to select **pcs**. (**pcs** :pieces)

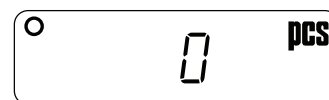

Storing The Sample Unit

- Press the **SAMPLE** key to enter the sample unit weight storing mode.

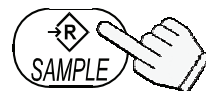

- To select the number of samples, press the **SAMPLE** key. It may be set to 5, 10, 25, 50, or 100.



- Place a tare container on the weighing pan, and press the **RE-ZERO** key. Confirm that the right side of the number of samples shows zero.

Switches the number of samples

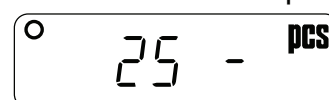

- Place the number of samples specified on the pan. In this example, 25 pieces.

Container

- Press the **PRINT** key to calculate and store the unit weight. Remove the sample. The balance is set to count objects with this unit weight.

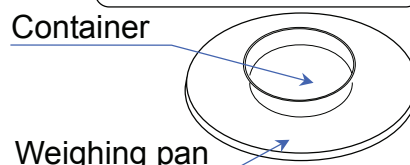

Weighing pan

- When a unit weight is too light to store, the display shows **Lo** for the moment and returns to the former display. When sample weight is light and the counting error could become large, the balance will request you to use a larger number of samples. Place the displayed number of samples on the pan and press the **PRINT** key to calculate and store the unit weight. See also "Sample quantity notice" and "Unit weight error" of "11.2.Error codes".

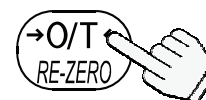

Confirm the display

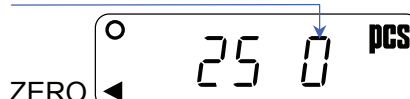

Samples (25 pcs)

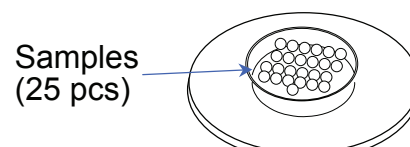

Counting The Objects

- Place the objects to be counted on the pan.

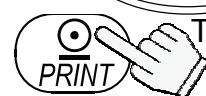

To store

Counting Mode Using The ACAI Function

ACAI™ (Automatic Counting Accuracy Improvement) is a function that improves the accuracy of the unit weight by increasing the number of samples as the counting process proceeds.

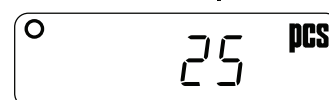

ACAI indicator

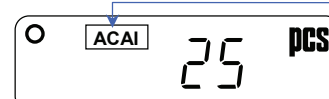

- After fixing the unit weight at step 6, add a few more samples on the pan. Then, the ACAI indicator turn on. (Add more than three pieces. But the indicator will not turn on for the number of samples beyond the ACAI range.)

- The ACAI indicator will blink and the balance re-calculates the unit weight. Do not touch the balance or samples on the pan until the ACAI indicator turns off.

10. Counting accuracy is improved when the ACAI indicator turns off. Each time the above operation is performed, a more accurate unit weight will be obtained. There is no definite upper limit of ACAI range for the number of samples exceeding 100. Try to add a similar number of samples as that displayed.

5.8. Percent Mode (%)

Displays the weight value in percentage compared to a reference (100%) weight.

Selecting The Percent Mode

1. Press the **UNITS** key to select %. (%:percent)

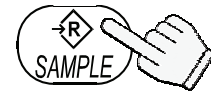
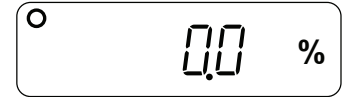

Storing The Reference (100%) Weight

2. Press the **SAMPLE** key to enter the reference weight storing mode.

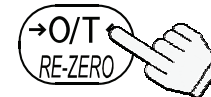

3. Press the **RE-ZERO** key to display 100 0%.



4. Place the sample to be set as the reference weight on the pan.

Sample corresponding to the 100% weight

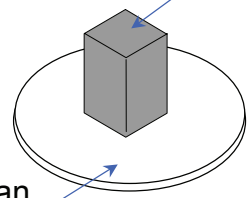

Weighing pan

5. Press the **PRINT** key to store the reference weight. Remove the sample.

- When a unit weight is too light to store, the display shows **L0** for the moment and returns to the former display.

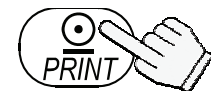

To store

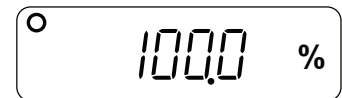

Object to be compared

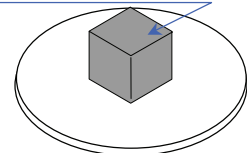

Reading The Percentage

6. Place the object to be compared to the reference weight on the pan. The displayed percentage is based on 100% of the reference weight.

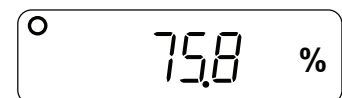

6. ACCUMULATION FUNCTION

- This function counts the number of times articles are weighed, calculates the total mass value and can display the number (accumulation count) and accumulated mass value.
- Preset the item "Hold" of the function list to use the accumulation function.
- The accumulation count and accumulated mass value are stored in the scale even if the power is removed.

Indicators And Keys

- The **M+** indicator is displayed when storing the accumulation data.
- The **M+** indicator and **TOTAL** is displayed when displaying the accumulated count and accumulated mass.
- Operation keys as follows :

The **UNITS** key

- When storing the accumulation data and pressing the **UNITS** key, the current measurement value, the accumulated count and accumulated mass value are displayed sequentially.
- When the accumulation data is not stored, the **UNITS** key switches the preset units sequentially.

The **RE-ZERO** key

- When displaying the measurement value and pressing the **RE-ZERO** key, the zero is displayed.
- While displaying the accumulated count and accumulated mass, when pressing the **RE-ZERO** key, the accumulation data is reset to the zero.

The **SAMPLE** key

The condition of the accumulation function is as follows :

- When a stable measurement value is above ± 5 digits from zero band.
 - The accumulated count is less than 1000.
 - The accumulated mass value is less than 9999999.
- The unit weight of the counting mode and the reference (100%) weight of the percent mode can not store when using the accumulation function.

Operations

Selecting A Weighing Unit

1. Select a unit to be used in the accumulation function with pressing the **UNITS** key.
- The unit can not change after storing the accumulation data. If changing the unit, reset the current accumulation data, change the unit. Plural units can not use at the same time.

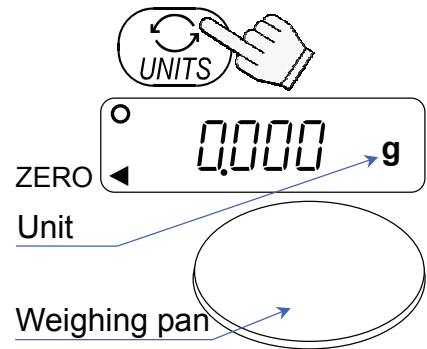

Adding Accumulation Data

2. Press the **RE-ZERO** key to display zero of the weighing measurement.
3. Place the sample on the pan.
4. When displaying stable measurement value, press the **SAMPLE** key to accumulate it. The **M+** indicator is displayed.
5. Repeat step 2, 3, 4 to weigh other samples. The **M+** indicator blinks at once for each sample.

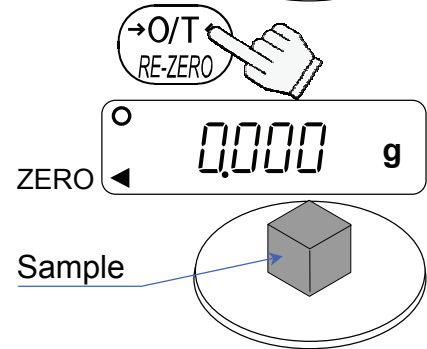

When accumulating data, the **M+** indicator is displayed.

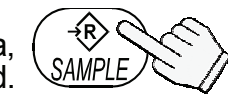

6. When pressing the **UNITS** key, the current measurement value, the accumulated count and accumulated mass value are displayed sequentially. The **M+** indicator and **TOTAL** is displayed when displaying the accumulated count and accumulated mass.

Measurement value (**M+** and unit)

Accumulated count (**M+** and **TOTAL**)

Accumulated mass (**M+**, **TOTAL** and unit)

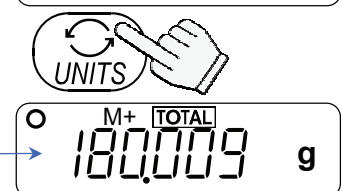
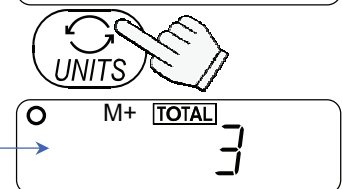
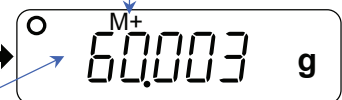

Deleting Accumulation Data

1. Display accumulated count or accumulated mass value.
2. Press the **RE-ZERO** key to reset the accumulated count and accumulated mass to zero. The **M+** indicator and **TOTAL** are turned off and the state of the balance proceeds to step 1 on this page.
- When the *Unit* of the function list is changed, the accumulation data are reset.

7. CALIBRATION

This function adjusts the balance for accurate weighing.
Perform calibration in the following cases.

- ❑ When the balance is first used.
- ❑ When the balance has been moved.
- ❑ For regular calibration.

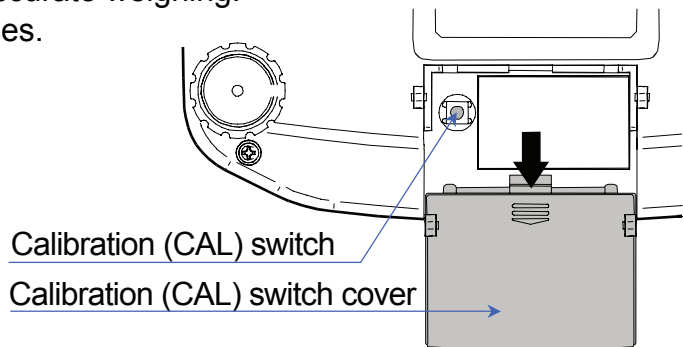

7.1. Calibration Using A Weight

- ❑ Prepare a calibration weight (sold separately) in advance.
1. Warm up the balance for at least half an hour with nothing on the pan.
 2. Press and hold the calibration (CAL) switch until **CAL** appears, and release the switch.
 3. The balance displays **CAL 0**.
To change the calibration weight value, proceed to step 4.
To use the calibration weight value in the balance memory, proceed to step 5.
 4. Press the **SAMPLE** key. The display shows the calibration weight value in “grams” that is stored in the balance. Use the following keys to change the value.
 - SAMPLE** keyTo select the digit blinking to be changed.
 - RE-ZERO** keyTo set the value of the digit selected.
 - PRINT** key.....To store the value and return to step 3.
 - UNITS** key.....To cancel the value and return to step 3.
 - ❑ Use a calibration weight more than 2/3 of the capacity.
 5. At step 3, press the **PRINT** key to weigh the zero-point value. Do not touch the pan during weighing. When the zero calibration is completed, the display will show the calibration weight value.
 - ❑ To perform the zero calibration only and finish the procedure, press the **UNITS** key. After displaying **End**, the balance turns off.
 6. Place a calibration weight with the same value as displayed on the pan.
Press the **PRINT** key to weigh it. Do not touch the pan during weighing.

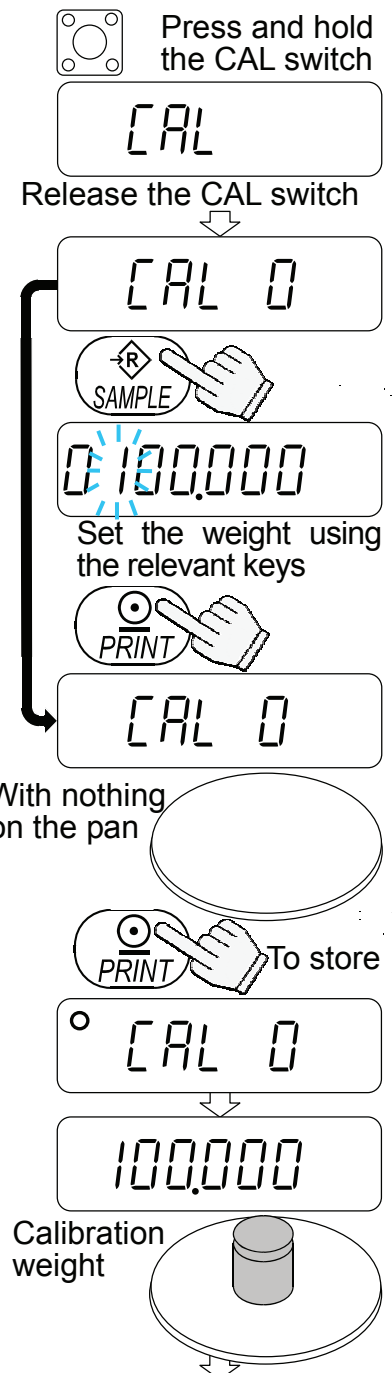

7. End is displayed.
Remove the weight from the pan.

When the GLP output (function setting “*info 1*” or “*info 2*”) is selected, GLP is displayed. The calibration report is output and End is displayed again. Then the balance will be turned off.

□ **Note**

The value set in step 4 is stored in memory even after the power is switched OFF.
If the balance is to be moved to other places, set the gravity acceleration value of the area where the calibration using a weight is to be done, and calibrate the balance according to the procedure above. See the next section to set the value.

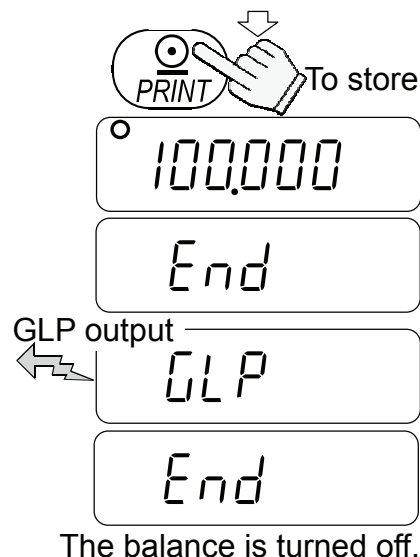

7.2. Gravity Acceleration Correction

When the balance is first used or has been moved to a different place, it should be calibrated using a calibration weight. But if a calibration weight is not available, the gravity acceleration correction will compensate the balance. Change the gravity acceleration value of the balance to the value of the area where the balance will be used. See the gravity acceleration map appended to the end of this manual.

□ **Note**

Gravity acceleration correction is not required when the balance is calibrated using a calibration weight at the place where the balance is to be used.

1. Press and hold the calibration (CAL) switch until CAL appears, and release the switch.
2. The balance displays CAL 0.
3. Press the RE-ZERO key. The display shows the gravity acceleration value stored in the balance. Use the following keys to change the value.
 - SAMPLE keyTo select the digit blinking to be changed.
 - RE-ZERO keyTo set the value of the digit selected.
 - PRINT key.....To store the value and return to step 2.
 - UNITS key.....To cancel the value and return to step 2.
4. After setting the value, press the PRINT key. End and CAL 0 is displayed again.
5. If it is necessary to calibrate the balance using a calibration weight, go to step 4 of "7.1. Calibration Using A Weight". To finish the setting, press the UNITS key.
6. The balance is turned off.

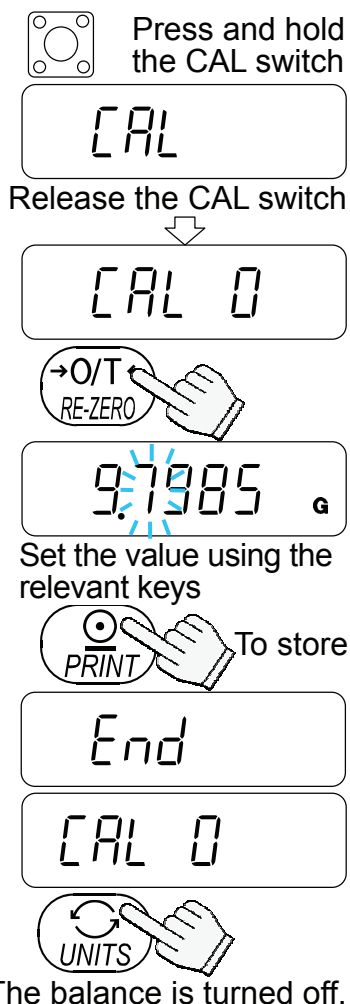

8. FUNCTIONS

8.1. Key Operation

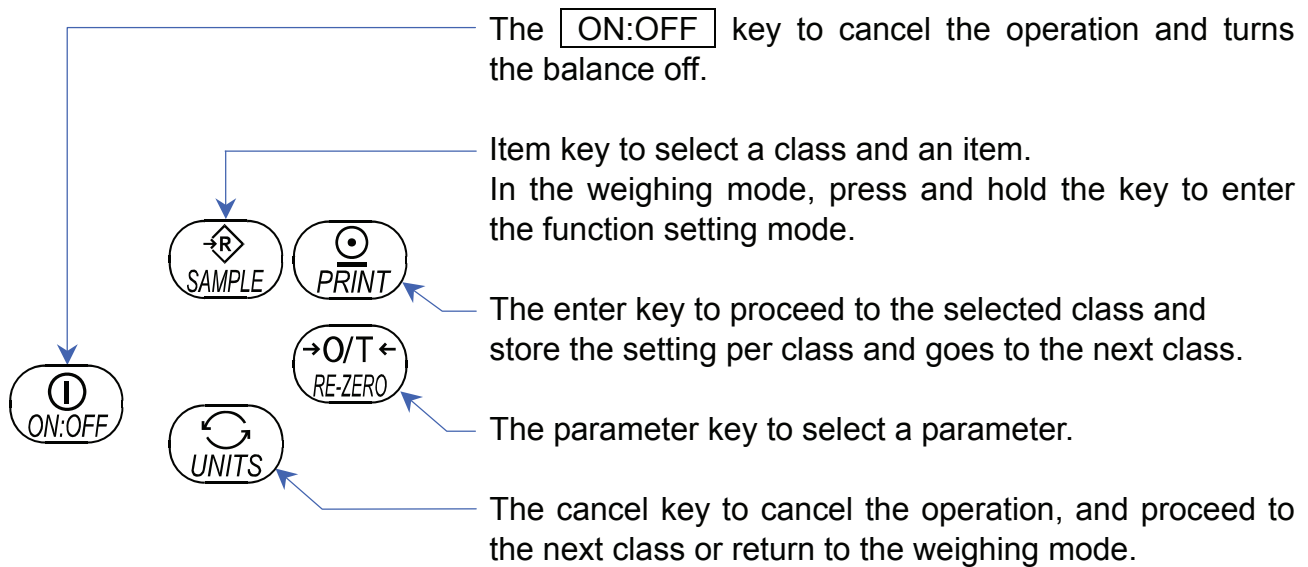

8.2. Entering The Function Setting Mode

In the weighing mode, press and hold the **SAMPLE** key to enter the function setting mode and display **Func**. Each time the **SAMPLE** key is pressed, the class appears one after another.

Once a class is selected, the items are available for selection. (Refer to “8.5. Function List”.)

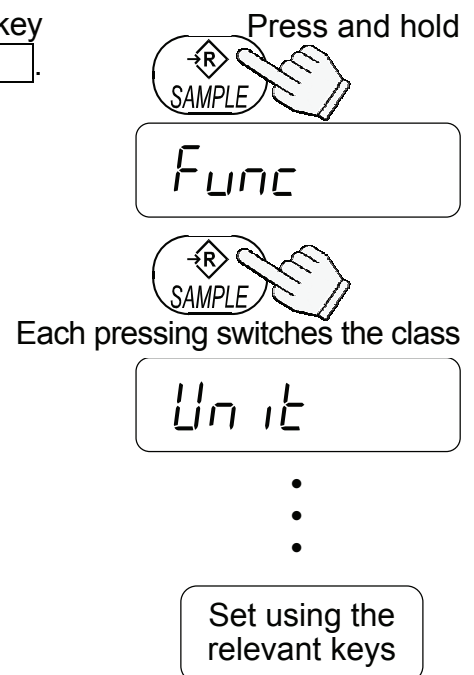

8.3. Setting Example

To set auto power-off function to “Enabled”, and the ACAI function to “Disabled”.

1. Press and hold the **SAMPLE** key to display **Func 0**.

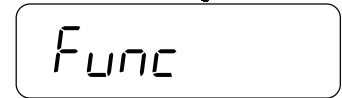

2. Press the **PRINT** key. The balance displays **PoFF 0**.



3. Press the **RE-ZERO** key to display **PoFF 1**.



Each pressing switches the parameter



4. Press the **SAMPLE** key several times to display **ACA, 1**.

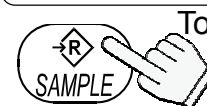

To confirm

5. Press the **RE-ZERO** key to select **ACA, 0**.

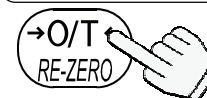

Each pressing switches the parameter



6. Press the **PRINT** key to store the parameters. **Unit** appears after **End**.



To store

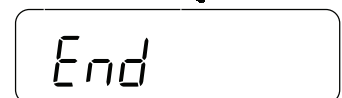

7. Press the **UNITS** key to turn off the balance.

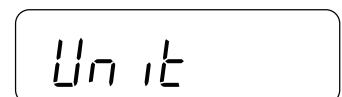

The balance returns off.

8.4. Storing Weighing Units

It is possible to store the weighing units that will actually be used from the units available. For the units available, see "5.3. Units".

Select and store the weighing units as described below:

1. Press and hold the **SAMPLE** key to display **Func**.

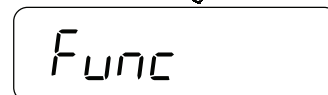

2. Press the **SAMPLE** key to display **Unit**.

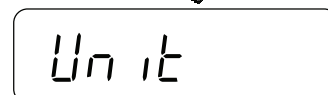
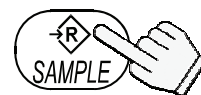

3. Press the **PRINT** key.

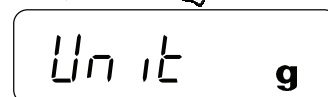

4. Press the **SAMPLE** key to display a weighing unit to be stored.

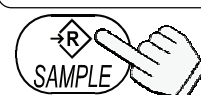

Each pressing switches the units available in the order described on "5.3.Units".

5. Press the **RE-ZERO** key to select the weighing unit. The selected weighing unit is shown with the STABLE indicator.

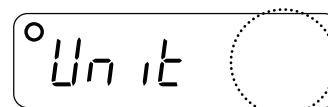

- At this stage, the weighing unit is not stored in memory.

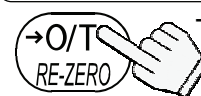

To select

6. Repeat steps 4. and 5. to store all weighing units to be used.



To store

7. Press the **PRINT** key to store the selected weighing units in memory. **id** is displayed after **End**.

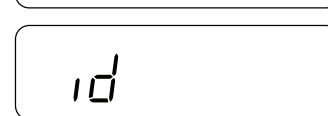

8. Press the **UNITS** key to turn off the balance.



The balance is turned off.

- **Note**

When the balance is switched ON, it starts with the unit that was stored first at step 5.

8.5. Function List

Class	Item	Parameter	Description	
Func	P _{OFF} Auto power-off	◆ 0	Auto power-off disabled	Automatically power off
		1	Auto power-off enabled	
	Cond Response	0	Fast / sensitive	Software filtering
		◆ 1		
	St-b Stability band width	2	Slow / stable	Conditions to turn on the STABLE indicator
		0	Stable when within ± 0.5d/1s	
		◆ 1	Stable when within ± 1d/1s	
	Zrc Zero tracking	2	Stable when within ± 2d/1s	Tracking zero shift
		0	Disabled	
	P _{nt} Decimal point	◆ 0	Point (.)	Decimal separator
		1	Comma (,)	
	P _{rt} Data output mode	0	Command and stream modes	Auto-print A: + data Auto-print B: +/- data
		◆ 1	Command and PRINT key	
		2	Command, PRINT key and auto-print A	
		3	Command, PRINT key and auto-print B	
	PUSE Data output pause	4	Command mode only	Interval between continuous data
		◆ 0	No pause (general equipment)	
	inF _o GLP output	1	1.6 seconds (for AD-8121)	GLP output format
		◆ 0	No output	
		1	AD-8121 format (*)	
	bPS Baud rate	2	General format	
		◆ 0	2400 bps	
		1	4800 bps	
		2	9600 bps	
	btPr Data and parity	3	1200 bps	
		◆ 0	7 bits, even parity	
		1	7 bits, odd parity	
	ACAI ACAI function	2	8 bits, non parity	If "0" is set, no additional samples required.
		0	ACAI disabled	
	U _{n in} Minimum unit weight	◆ 1	ACAI enabled	d = digit : in unit of minimum display
		◆ 0	1 d	
		1	1/10 d	
	S _{nPL} Sample number	2	total sample weight ≥ 5d (**)	The number of samples shown first when entered into the unit weight storing mode
		◆ 0	10 pcs	
		1	25 pcs	
		2	50 pcs	
		3	100 pcs	
		4	5 pcs	

◆ : Factory setting

* : When the AD-8121 format is selected, the interval between data is 1.6 seconds regardless of the setting "PUSE".

** : Even if the weight display is "5d", the sample weight may not be accepted. This is because the weight display data is rounded off internally.

Class	Item	Parameter	Description	
Func	Ld in Liquid density input	◆ 0	Water temperature	The way to input liquid density.
		1	Liquid density	
	Hold Display hold function	◆ 0	Not used	d = digit : in unit of minimum display Hold: When a stable value leaves more than 4 digits from zero band, the display value is held. When the value is change more than a limit, the display hold is released.
		1	Hold. Limit : ±10 d.	
		2	Hold. Limit : ±50 d.	
		3	Hold. Limit : ±100 d.	
		4	Hold. Limit : ±200 d.	
	totL Accumulation function	◆ 0	Not used	
		1	Accumulated	
	L L U P LCD Backlight control	0	Always off	To control how the LCD backlight turns off. Weight change or key operation will turn the backlight on.
		1	Turns off after 5 seconds	
		2	Turns off after 10 seconds	
		◆ 3	Turns off after 30 seconds	
		4	Turns off after 60 seconds	
		5	Always on	
Unit	Weighing units to be displayed		Sets to display units	Refer to “8.4. Storing Weighing Units”
	id	ID number for GLP output	Sets the ID number	Refer to “10. ID NUMBER AND GLP”

◆ : Factory setting

9. OPTIONS

The following options are available for the EJ-123 balance:

- EJ-02 USB interface
- EJ-03 RS-232C serial interface
- EJ-13 Density determination kit

□ **Note**

The EJ-123 balance have only one option slot for a communications interface. Either the EJ-02 USB interface or the EJ-03 RS-232C serial interface can be installed at one time.

9.1. EJ-02 USB Interface

The EJ-02 allows an EJ-123 balance to be connected with a printer or a personal computer with the USB interface.

- The EJ-02 can transmit the weight data (numerical value only) uni-directionally to a personal computer via USB.
- The EJ-02 can transmit the weight data (numerical value only) directly to application software such as Microsoft Excel, Word, memo pad, and so on.
- A special USB software driver is not necessary.
- The EJ-02 cannot be used for bidirectional communication.

EJ-02 Installation

1. Turn off the balance and disconnect the AC adapter if used.
2. Remove the cover of the option slot on the rear by pressing and lowering it down.
3. Connect the connector in the slot to the EJ-02 unit and insert it into the slot.
4. Secure the EJ-02 with the screws supplied with the option.

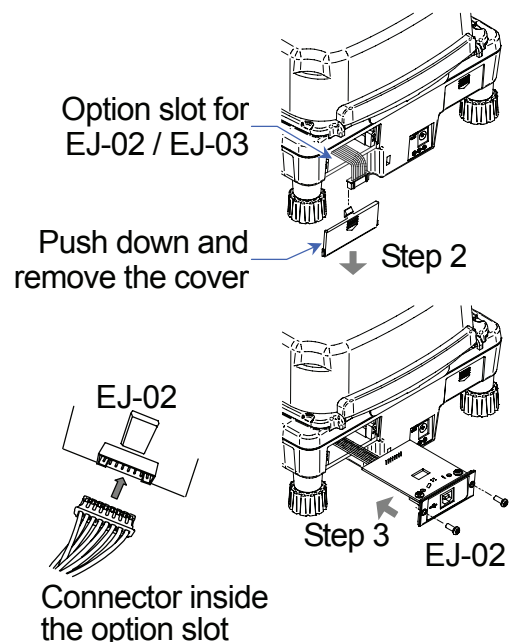

9.2. EJ-03 RS-232C Serial Interface

The EJ-03 allows an EJ-123 balance to be connected with a printer or a personal computer with the RS-232C interface.

- The RS-232C serial interface has the following four modes.
 - Stream mode.....Outputs data continuously.
 - Key mode.....Outputs data by pressing the **PRINT** key.
 - Auto-print modeOutputs data which meets the conditions of auto-print.
 - Command mode.....Controls the balance using commands from a computer.
- Set the parameters of the data format (b^P5 and b^tPr) and data output mode (Prt), as necessary.
- Use a D-Sub 9 pin cable (straight type) to connect with a computer.
Optional cable: AX-KO2466-200 D-Sub 9 pin / 9 pin cable (2 m long)

EJ-03 Installation

1. Turn off the balance and disconnect the AC adapter if used.
2. Remove the cover of the option slot on the rear by pressing and lowering it down.
3. Connect the connector in the slot to the EJ-03 unit and insert it into the slot.
4. Secure the EJ-03 with the screws supplied with the option.

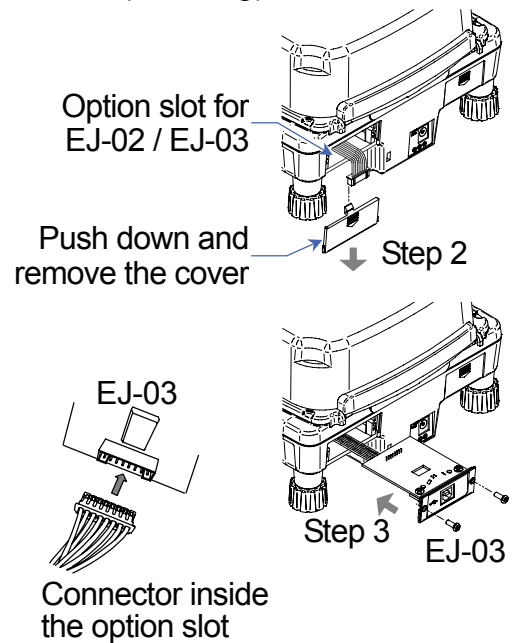

Interface Specifications

Transmission system	EIA RS-232C
Transmission form	Asynchronous, bi-directional, half-duplex
Data format	Baud rate: 1200, 2400, 4800, 9600 bps
	Data: 7 bits + parity 1bit (even or odd) or 8 bits (non-parity)
	Start bit: 1 bit
	Stop bit: 1 bit
	Code: ASCII
	Terminator: C_{RLF} (C_R : 0Dh, L_F : 0Ah)

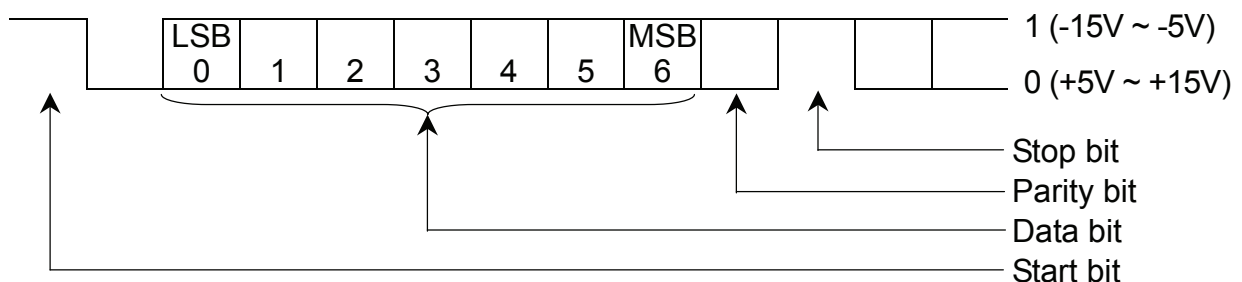

Pin Connections

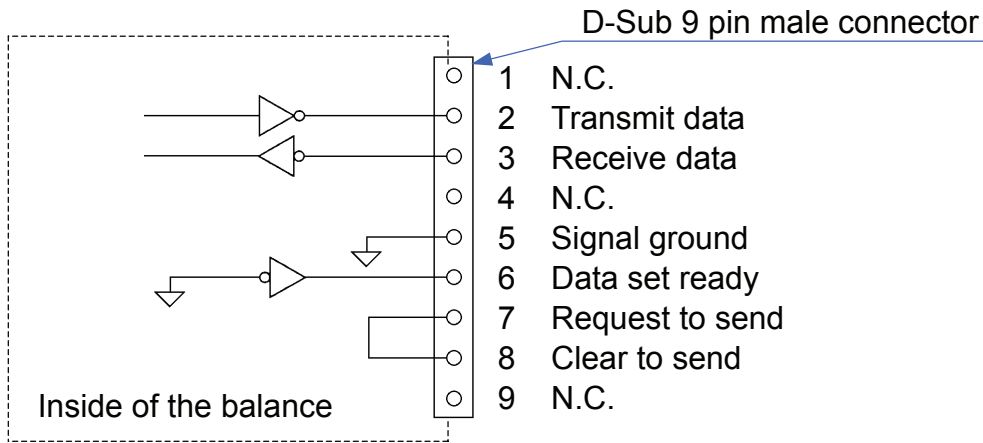

The interface is designated as DCE (Data Communication Equipment).

9.3. Data Format

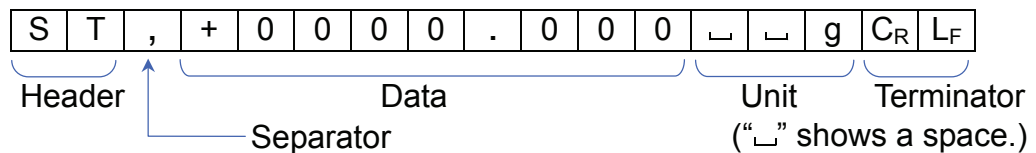

- There are four types of headers:
 - ST : Stable weighing data (including % data)
 - QT : Stable counting data
 - US : Unstable weighing data (including counting and % data)
 - OL : Out of weighing range (Over)
- The data is normally 9 digits including a decimal point and a sign.
- There are 10 types of units:
 - g : Weighing data “gram”
 - P C : Counting data “pcs”
 - % : Percentage data “%”
 - o z : Weighing data “decimal ounce”
 - o z t : Weighing data “troy ounce”
 - c t : Weighing data “carat”
 - d w t : Weighing data “penny weight”
 - GN : Weighing data “grain”
 - N : Force data “Newton”
 - D S : Calculated density (specific gravity) value
- The terminator is always C_RL_F.
- Example of output data:

Weighing data “gram”	S	T	,	+	0	0	1	2	.	3	4	5			g	C _R	L _F
Counting data	Q	T	,	+	0	0	0	1	2	3	4	5		P	C	C _R	L _F
Percentage data	S	T	,	+	0	0	0	1	2	3	.	4			%	C _R	L _F
Out of range “gram” (+)	O	L	,	+	9	9	9	9	.	9	9	9			g	C _R	L _F
Out of range “pcs” (-)	O	L	,	-	9	9	9	9	9	9	9	9		P	C	C _R	L _F

Data Output Mode

- Stream mode
Set the function to “Prt 0”.
The balance outputs the current display data. The data-update rate is approximately 10 times per second. This rate is the same as the display-update.
The balance does not output data while it is in the setting mode.
- Key mode
Set the function to “Prt 1, 2 or 3”.
When the **PRINT** key is pressed while the weight data is stable (the STABLE indicator is on), the balance transmits the data. When the data is transmitted, the display will blink one time.
- Auto-print mode A
Set the function to “Prt 2”.
The balance transmits the weight data when the display is stable (the STABLE indicator is on) and the data is greater than +4 digits.
The next output can be obtained after the display returns below +4 digits.
- Auto-print mode B
Set the function to “Prt 3”.
The balance transmits the weight data when the display is stable (the STABLE indicator is on) and the data is greater than +4 digits or less than -4 digits.
The next output can be obtained after the display returns between -4 digits and +4 digits.

Command Mode

In the command mode, the balance is controlled by commands that come from the personal computer and so on.

Command List

- Command to request the current weighing data.
Command

Q	C _R	L _F
---	----------------	----------------

Reply

S	T	,	+	0	0	1	2	.	3	4	5	┐	┐	g	C _R	L _F
---	---	---	---	---	---	---	---	---	---	---	---	---	---	---	----------------	----------------
- Command to zero or tare the balance (same as the **RE-ZERO** key).
Command

Z	C _R	L _F
---	----------------	----------------

Reply

Z	C _R	L _F
---	----------------	----------------
- Command to change the weighing units (same as the **UNITS** key).
Command

U	C _R	L _F
---	----------------	----------------

Reply

U	C _R	L _F
---	----------------	----------------

9.4. EJ-13 Density Determination Kit

Using this option and calculation program, the balance can determine the density (specific gravity) of a sample.

EJ-13 Installation

- ❑ Remove the weighing pan and the fixing frame.
- ❑ Install the beaker stand on the balance and attach the pan stand to the pan support of the balance.
- ❑ Remove the breeze break that can not be used while using the density determination kit.
- ❑ Place a beaker filled with water on the beaker stand and place the sample weighing pan on top of the pan stand.

Density (Specific Gravity) Measurement

- ❑ The density for a liquid can be set two ways. One is to set the water temperature and the other is to set the density value directly.
- ❑ The factory setting for density of a liquid is 25 °C as water temperature (the density value, $\rho = 0.99704 \text{ (g/cm}^3\text{)}$, is used for calculation).
- ❑ The result is shown with three decimal places.
- ❑ The density (specific gravity) is calculated by the following formula.

$$S = \frac{A}{A - B} \times \rho$$

S: Density (specific gravity) of a sample
 A: Weight in air
 B: Weight in liquid
 ρ : Density of liquid (water)

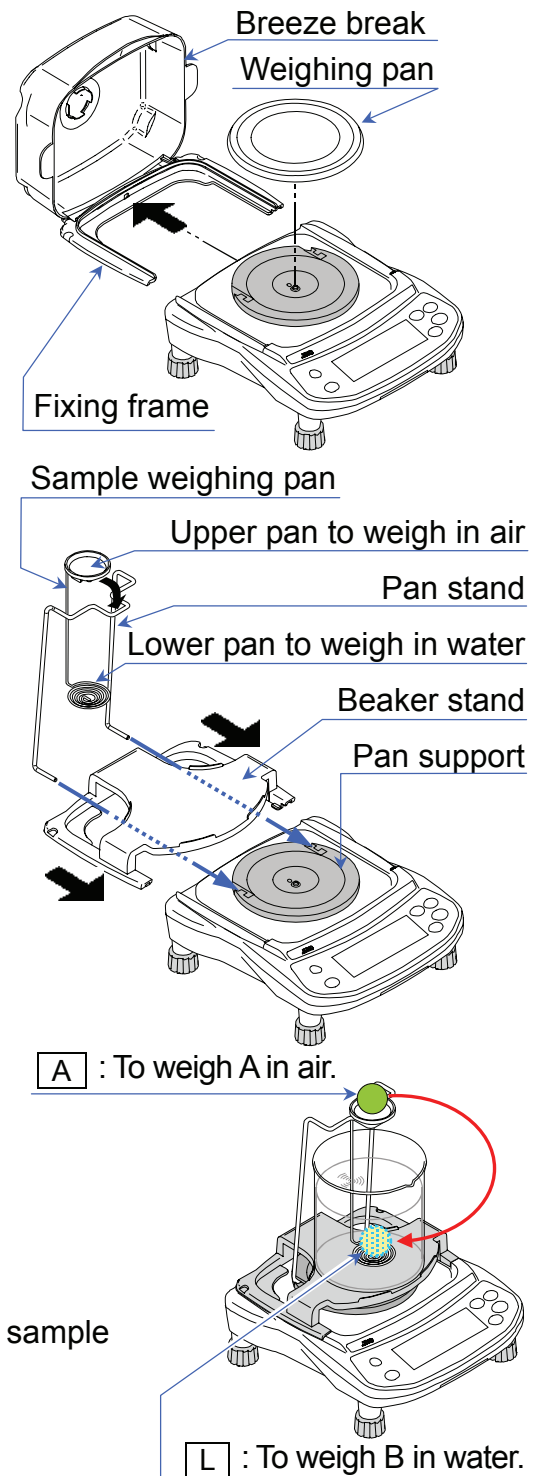

Change the function table

Selecting a way to set the density of a liquid

Select the liquid density input method from the function table below.

The function table is available only when the density measurement mode is selected.

Class	Item	Parameter	Description
Func	Ld in Liquid density input	◆ □	Water temperature
		!	Liquid density

◆ : Factory setting

Entering the density of a liquid ($Ld_{in} = 0$)

1. Press the **UNITS** key to select **SG**.
 2. Press and hold the **UNITS** key to display the liquid density input mode. The display will show the water temperature currently set (factory setting: 25 °C).
 3. Using the **RE-ZERO** (to increment the value) and **SAMPLE** keys (to shift the selected digit), set the value and press the **PRINT** key to store.
- To cancel the setting procedure and return to the density measuring mode, press the **UNITS** key. The input value is not stored.
 - The relation between the water temperature and density is shown below.

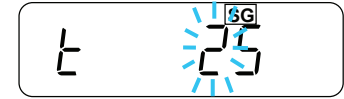
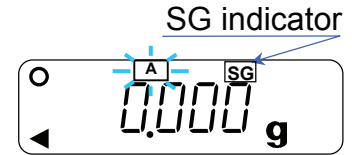

°C	+0	+1	+2	+3	+4	+5	+6	+7	+8	+9
0	0.99984	0.99990	0.99994	0.99996	0.99997	0.99996	0.99994	0.99990	0.99985	0.99978
10	0.99970	0.99961	0.99949	0.99938	0.99924	0.99910	0.99894	0.99877	0.99860	0.99841
20	0.99820	0.99799	0.99777	0.99754	0.99730	0.99704	0.99678	0.99651	0.99623	0.99594
30	0.99565	0.99534	0.99503	0.99470	0.99437	0.99403	0.99368	0.99333	0.99297	0.99259
40	0.99222	0.99183	0.99144	0.99104	0.99063	0.99021	0.98979	0.98936	0.98893	0.98849
50	0.98804	0.98758	0.98712	0.98665	0.98618	0.98570	0.98521	0.98471	0.98422	0.98371
60	0.98320	0.98268	0.98216	0.98163	0.98110	0.98055	0.98001	0.97946	0.97890	0.97834
70	0.97777	0.97720	0.97662	0.97603	0.97544	0.97485	0.97425	0.97364	0.97303	0.97242
80	0.97180	0.97117	0.97054	0.96991	0.96927	0.96862	0.96797	0.96731	0.96665	0.96600
90	0.96532	0.96465	0.96397	0.96328	0.96259	0.96190	0.96120	0.96050	0.95979	0.95906

Entering the density of a liquid directly ($Ld_{in} = 1$)

1. Press the **UNITS** key to select **SG**.
 2. Press and hold the **UNITS** key to display the liquid density input mode. The display will show the liquid density currently set (factory setting: 1.0000 g/cm³).
 3. Using the **RE-ZERO** (to increment the value) and **SAMPLE** keys (to shift the selected digit), set the value and press the **PRINT** key to store.
- To cancel the setting procedure and return to the density measuring mode, press the **UNITS** key. The input value is not stored.

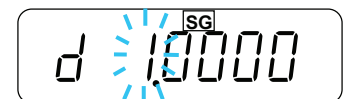

Example of density measurement

Selecting the density measurement mode

1. Press the **UNITS** key to select **SG** .
 - ❑ The weighing unit is “g”.
 - ❑ The display shows that **A** blinks and the balance is measuring the weight in air.
 - ❑ When the display does not show zero, press the **RE-ZERO** key to set the display to zero.
2. Place a sample on the upper pan.
3. Wait for the **STABLE** indicator to be displayed and press the **SAMPLE** key to store the weight in air.
4. The display shows that **L** blinks and the balance starts to measure the weight in water.
5. Place the sample on the lower pan in water.
 - ❑ Adjust the amount of water so that the sample is about 10 mm below the water surface.
6. Wait for the **STABLE** indicator to be displayed and press the **SAMPLE** key. Then the balance reads the weight in water and shows the density (specific gravity) of the sample.
7. To continue the density measurement, press the **SAMPLE** key again. To exit this measurement, press the **UNITS** key.

Measuring weight in air.

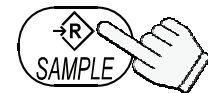
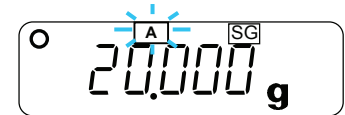
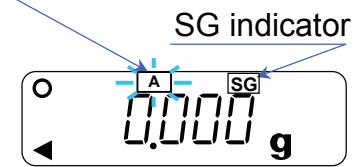

Measuring weight in water.

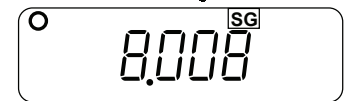
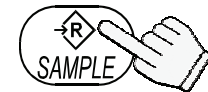
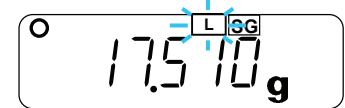
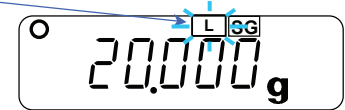

A : To weigh the sample in air.

L : To weigh the sample in water.

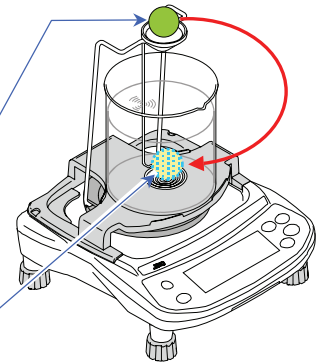

10. ID NUMBER AND GLP

- ❑ The ID number is used to identify the balance when Good Laboratory Practice (GLP) is used.
- ❑ The ID number is stored in memory even if power to the balance is switched OFF.
- ❑ The following GLP data is transmitted to a printer or a computer using the optional RS-232C serial interface.
 - The result of calibration (“Calibration report”)
 - The result of calibration test (“Calibration test report”)
 - The “Title block” and “End block” for GLP data
- ❑ The GLP output format includes the balance manufacturer name, model number, serial number, ID number and space for a signature.
- ❑ When used with the AD-8121B, the date and time can be printed (GLP output format *info = 1*).

10.1. Setting The ID Number

1. Press and hold the **SAMPLE** key to display **Func**.
2. Press the **SAMPLE** key several times to display **id**.
3. Press the **PRINT** key. Enter the ID number using the following keys.
 - SAMPLE** key To select the digit blinking to be changed.
 - RE-ZERO** key To set the character of the digit selected. See the table below for the “display character set”.
 - PRINT** key To store the value and proceed to the next step.
 - UNITS** key To cancel the value and proceed to the next step.
4. When the above operation has been completed, **Func** appears after **End**.
5. Press the **UNITS** key to turn off the balance.

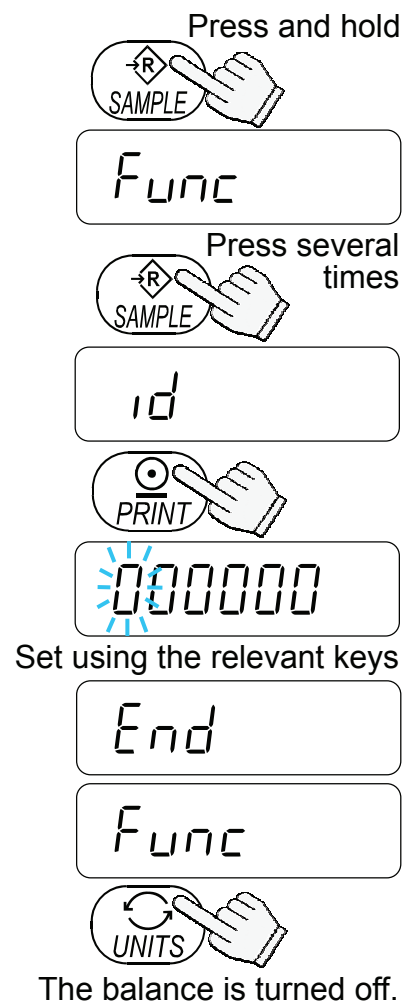

Display Character Set

0	1	2	3	4	5	6	7	8	9	-	_	A	B	C	D	E	F	G	H	I	J	K	L	M	N	O	P	Q	R	S	T	U	V	W	X	Y	Z	
0	1	2	3	4	5	6	7	8	9	-	_	A	b	C	d	E	F	G	H	,	U	U	L	n	n	o	P	q	r	S	t	U	u	y	1	1	2	2

“_” : Space

10.2. GLP Report

- To print the GLP report, set the function to “*Info 1*”, “*PUSE 1*” and set the AD-8121B printer to MODE 3.
- To output the GLP report to a personal computer, set the function to “*Info 2*”, “*PUSE 0*”.

Calibration Report

Perform calibration using a weight. Then the balance will output a calibration report. Refer to “7.1. Calibration Using A Weight” about the calibration.

1. Perform calibration according to “7.1. Calibration Using A Weight”.
2. `End` appears when the calibration has been completed.
3. `GLP` is displayed and calibration report is output.
4. `End` is displayed again. Remove the weight. The balance is turned off.

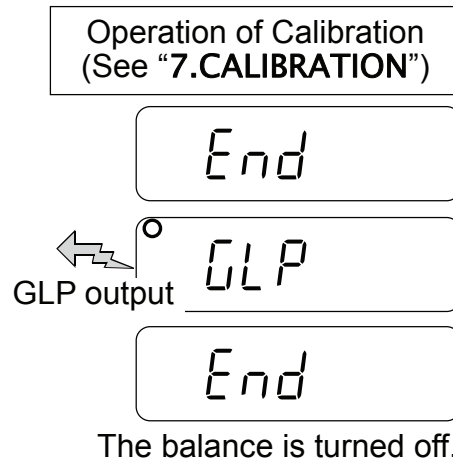

AD-8121 format “*Info 1*”

```

      A & D
MODEL    EJ-123
S/N      012345678
ID        ABCDEF
DATE     2013/11/14
TIME     02:53:21
CALIBRATED(EXT.)
CAL.WEIGHT
      +100.000 g
SIGNATURE
-----
    
```

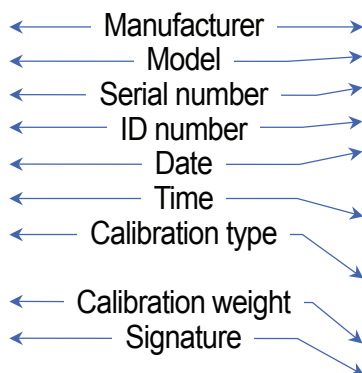

General format “*Info 2*”

```

.....A&D<CRLF>
MODEL.....EJ-123<CRLF>
S/N.....Q12345678<CRLF>
ID.....ABCDEF<CRLF>
DATE<CRLF>
<CRLF>
TIME<CRLF>
<CRLF>
CALIBRATED(EXT.)<CRLF>
CAL.WEIGHT<CRLF>
.....+100.000..g<CRLF>
SIGNATURE<CRLF>
<CRLF>
<CRLF>
-----<CRLF>
<CRLF>
<CRLF>
    
```

- ␣ : Space, ASCII 20h
- CR : Carriage return, ASCII 0Dh
- LF : Line feed, ASCII 04Ah

Calibration Test Report

- The calibration test mode is used to compare a calibration test weight with the calibration test data weighed by the balance.
 - This test does not perform calibration and this mode is available even after sealing the calibration (CAL) switch.
1. Press and hold the **SAMPLE** and **PRINT** keys. **CC** will appear. Then, release both keys.
 - Pressing and holding the calibration (CAL) switch will also display **CC** after **CAL**. Then, release the CAL switch while showing **CC**.
 2. **CC 0** is displayed.
 3. If necessary, change the value of calibration test weight according to the procedure step 4 of “7.1. Calibration Using A Weight”.
 4. With nothing on the pan, press the **PRINT** key. The zero point is measured and the weighed value is displayed for a few seconds. Then, the display shows the value of calibration test weight.
 5. Place a weight of the same value as displayed on the pan and press the **PRINT** key to weigh it. The weighed value is displayed for a few seconds.
 6. **End** appears.
 7. **GLP** is displayed and calibration test report is output.
 8. **End** appears again. Remove the weight. The balance is turned off.

Press and hold both keys.

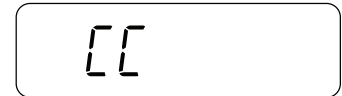

Release both keys.

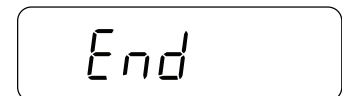
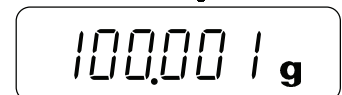
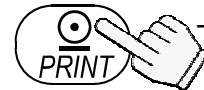
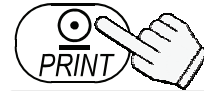
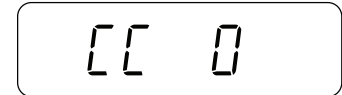

To output calibration test report

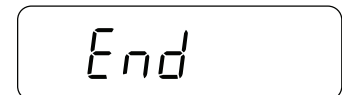
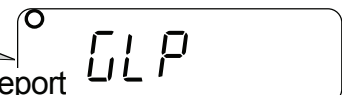

The balance is turned off.

AD-8121 format “info 1”

```

      A & D
MODEL    EJ-123
S/N      012345678
ID        ABCDEF
DATE     2013/11/14
TIME     02:53:21
CAL.TEST(EXT.)
ACTUAL
          0.000  g
          +100.001  g
TARGET
          +100.000  g
SIGNATURE
-----
  
```

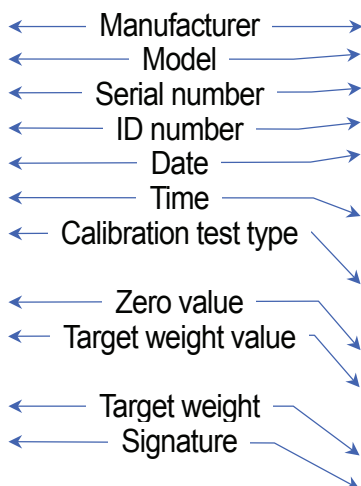

General format “info 2”

```

_____A_&_D<CRLF>
MODEL_____EJ-123<CRLF>
S/N_____Q12345678<CRLF>
ID_____ABCDEF<CRLF>
DATE<CRLF>
<CRLF>
TIME<CRLF>
<CRLF>
CAL.TEST(EXT.)<CRLF>
ACTUAL<CRLF>
_____0.000__g<CRLF>
_____+100.001__g<CRLF>
TARGET<CRLF>
_____+100.000__g<CRLF>
SIGNATURE<CRLF>
<CRLF>
<CRLF>
-----<CRLF>
<CRLF>
<CRLF>
  
```

- ␣ : Space, ASCII 20h
- CR : Carriage return, ASCII 0Dh
- LF : Line feed, ASCII 04Ah

Output Of “Title Block” And “End Block”

- When a weight value is recorded as the GLP report. “Title block” and “End block” are added at the beginning and at the end of a group of weight values.

“Title Block”

1. Press and hold the **PRINT** key. Release the **PRINT** key when **StArT** is displayed. The balance outputs the “Title block”.
2. The balance can output the weight data by pressing the **PRINT** key or selecting the auto-print mode.

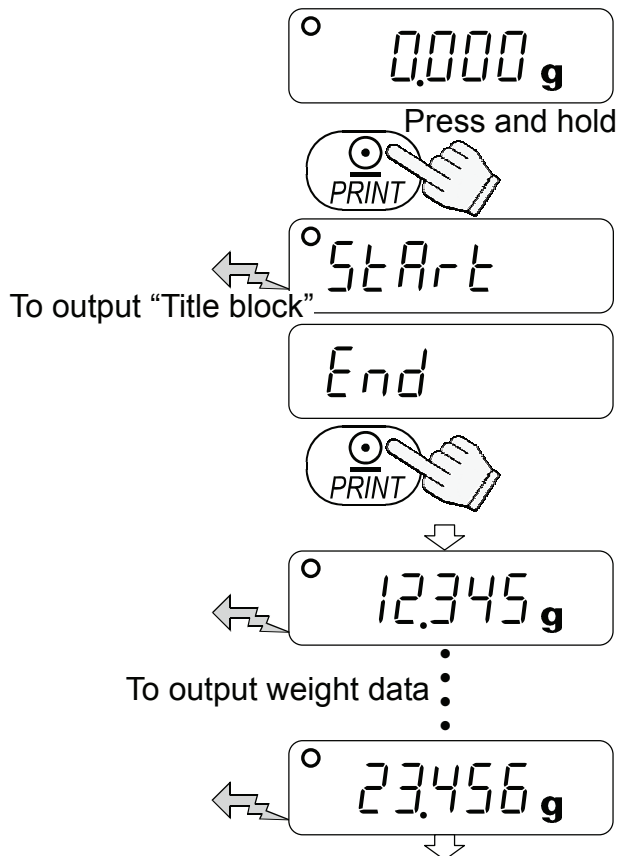

“End Block”

3. Press and hold the **PRINT** key. Release the **PRINT** key when `rEcEnd` is displayed. The balance outputs the “End block”.
4. `End` is displayed. The balance return to the weighing mode.

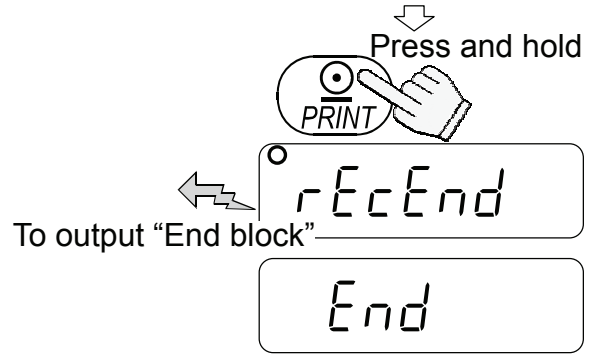

The balance return to the weighing mode.

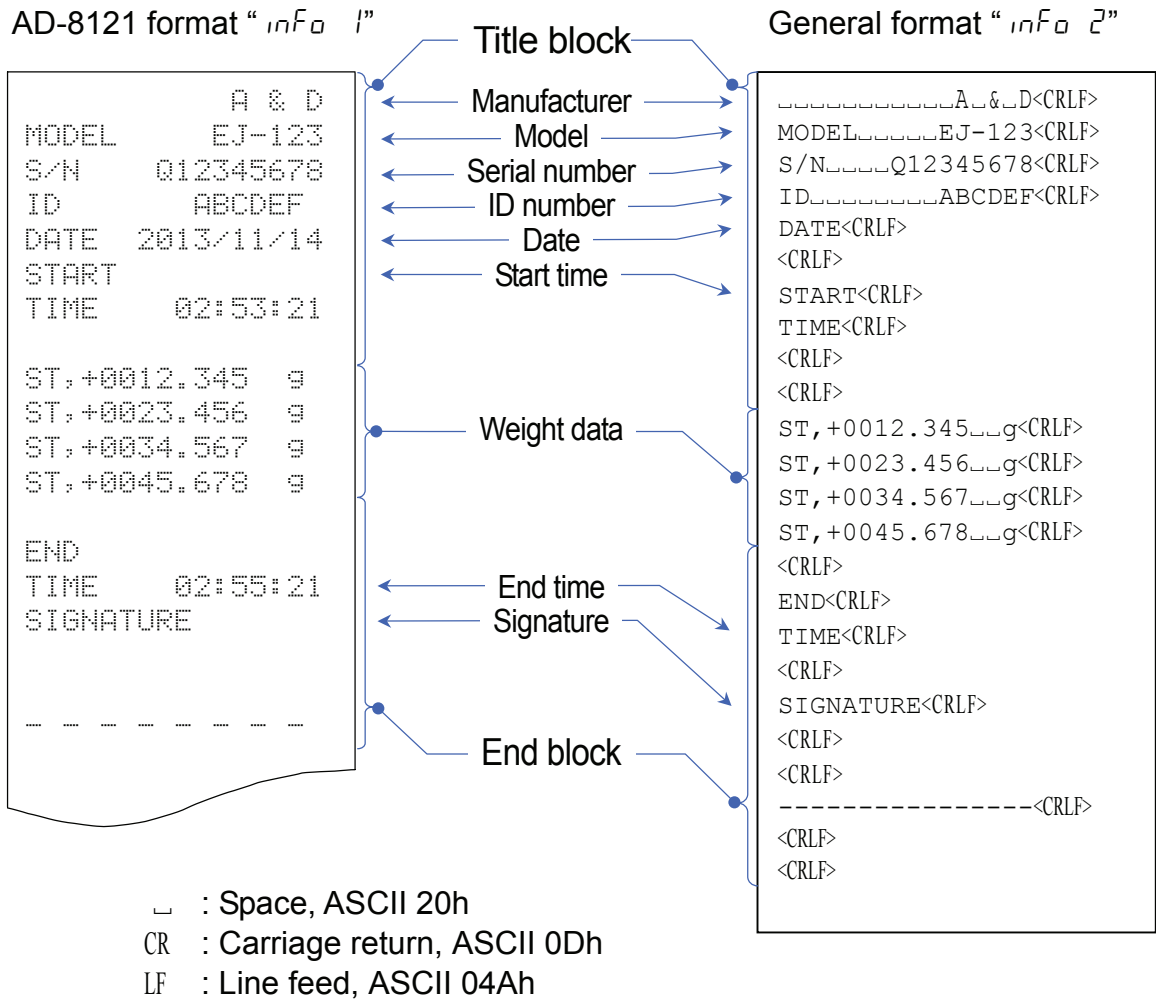

11. MAINTENANCE

11.1. Notes On Maintenance

- ❑ Do not disassemble the balance. Contact your local A&D dealer if your balance needs service or repair.
- ❑ Please use the original package for transportation.
- ❑ Do not use organic solvents to clean the balance. Use a lint free cloth dampened with warm water and a mild detergent.
- ❑ To clean around the pan support, refer to the illustrations below.

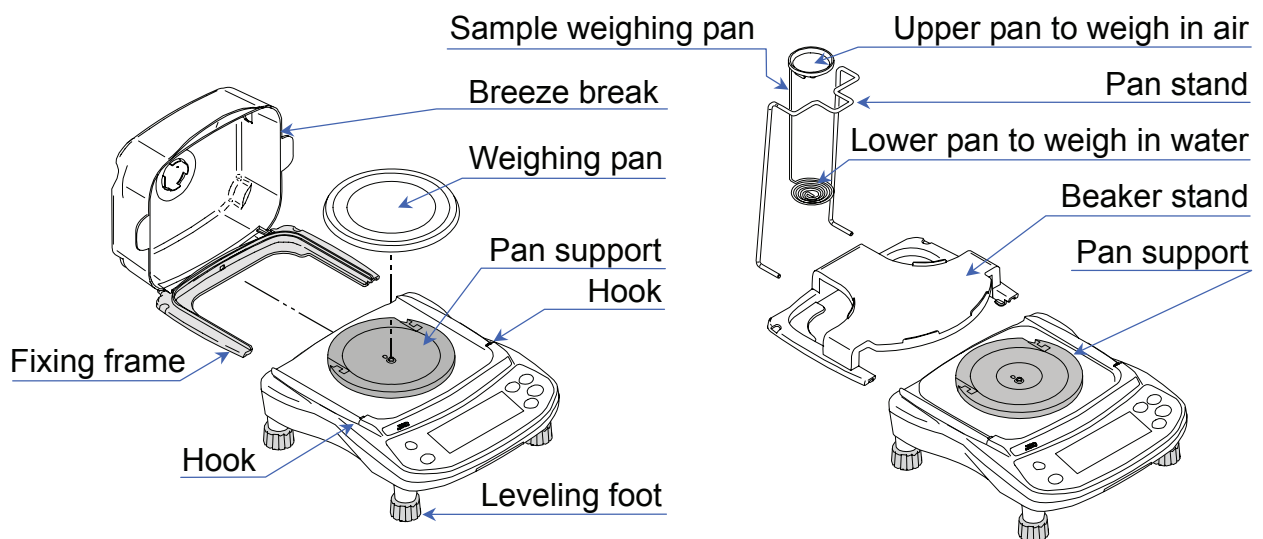

11.2. Error Codes

Overload error

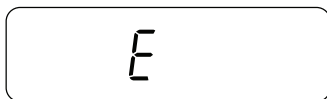

Warning to indicate that an object beyond the balance capacity has been placed on the pan. Remove the object from the pan.

Range over notice

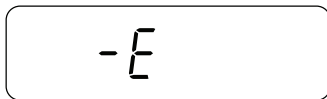

This will be shown if the weight sensor receives strong force upward. Check if there is anything sandwiched around the weighing pan. There is a possibility that the weight sensor itself may have a failure.

Unit / 100% weight error



The sample weight is too light to set the unit weight in the counting mode or 100% reference weight in the % mode.

Sample quantity notice



When sample weight is light and the counting error could become large, the balance will request you to use larger number of samples. Place the displayed number of samples on the pan and press the **PRINT** key to store the unit weight.



Note: Pressing the **PRINT** key without adding samples may reduce the counting accuracy. Starting from the 100 samples, **100 -** may be displayed when the sample weight is light. In this case, press the **PRINT** key without adding any samples. When “**ACAI, 0**” (ACAI disabled) or “**Unit 2**” is selected, this notice is not shown.

CAL errors

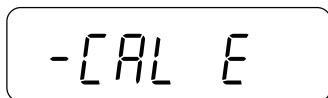

Warning to indicate that calibration has been canceled because the calibration weight is too light. Check the weighing pan and the calibration weight.

Battery error

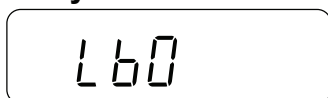

Warning to show that the batteries are exhausted. Replace them with new one or use the AC adapter.

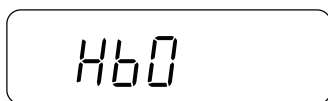

Warning to show that the battery voltage is too high. Check the battery.

AC adapter error

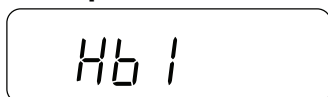

Warning to show that the output voltage of an AC adapter is too high. Check if the AC adapter is the correct type.

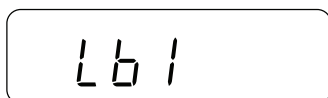

Warning to show that the output voltage of an AC adapter is too low. Check if the AC adapter is the correct type.

Stability error



Warning to indicate that the weight value is not stable and the balance cannot display it. Prevent vibration and drafts. Press the **UNITS** key to return to the weighing mode.

Internal errors (# is number except 1.)



The balance detects error state in the internal processing. With nothing on the weighing pan, turn the power off and on again. If the error persists, request service.

If you cannot cancel an error or other errors have occurred, request service from the store where you purchased the balance or from your local A&D dealer.

12. SPECIFICATIONS

12.1. Generals

MODEL	EJ-123
Weight capacity	120 g
Minimum display “d” = digit	0.001 g
Repeatability (Standard deviation)	0.003 g
Linearity	±0.003 g
Sensitivity drift	±20 ppm / °C (10 °C to 30 °C / 50 °F to 86 °F)
No. of samples	5, 10, 25, 50 or 100 pieces
Max. count *	120,000 pcs
Min. unit weight *	0.001 g
Min. % display	0.01 %
Min. 100 % weight	0.1 g
Display	7 segment LCD display with backlight (Character height 16 mm)
Display update	10 time per second
Operating temp.	10 °C to 30 °C / 50 °F to 86 °F, less than 85 %R.H. (non-condensing)
Power supply	AC adapter or 4 x “AA” size dry-cell batteries
Battery operation	Approximately 80 hours (backlight off, alkaline batteries)
Weighing pan size	110 mm ø
Weight	Approximately 1160 g
Calibration weight (factory setting)	100 g

* : In case of “Unit in g” (factory setting)

12.2. Weighing Units

MODEL		EJ-123
oz	Capacity	4.2329 oz
	Min. display	0.0001 oz
ozt	Capacity	3.8581 ozt
	Min. display	0.0001 ozt
ct	Capacity	600.000 ct
	Min. display	0.005 ct
dwt	Capacity	77.162 dwt
	Min. display	0.001 dwt
GN	Capacity	1851.88 GN
	Min. display	0.02 GN

12.3. Options

- EJ-02 USB interface
- EJ-03 RS-232C serial interface
- EJ-13 Density determination kit

12.4. Dimensions

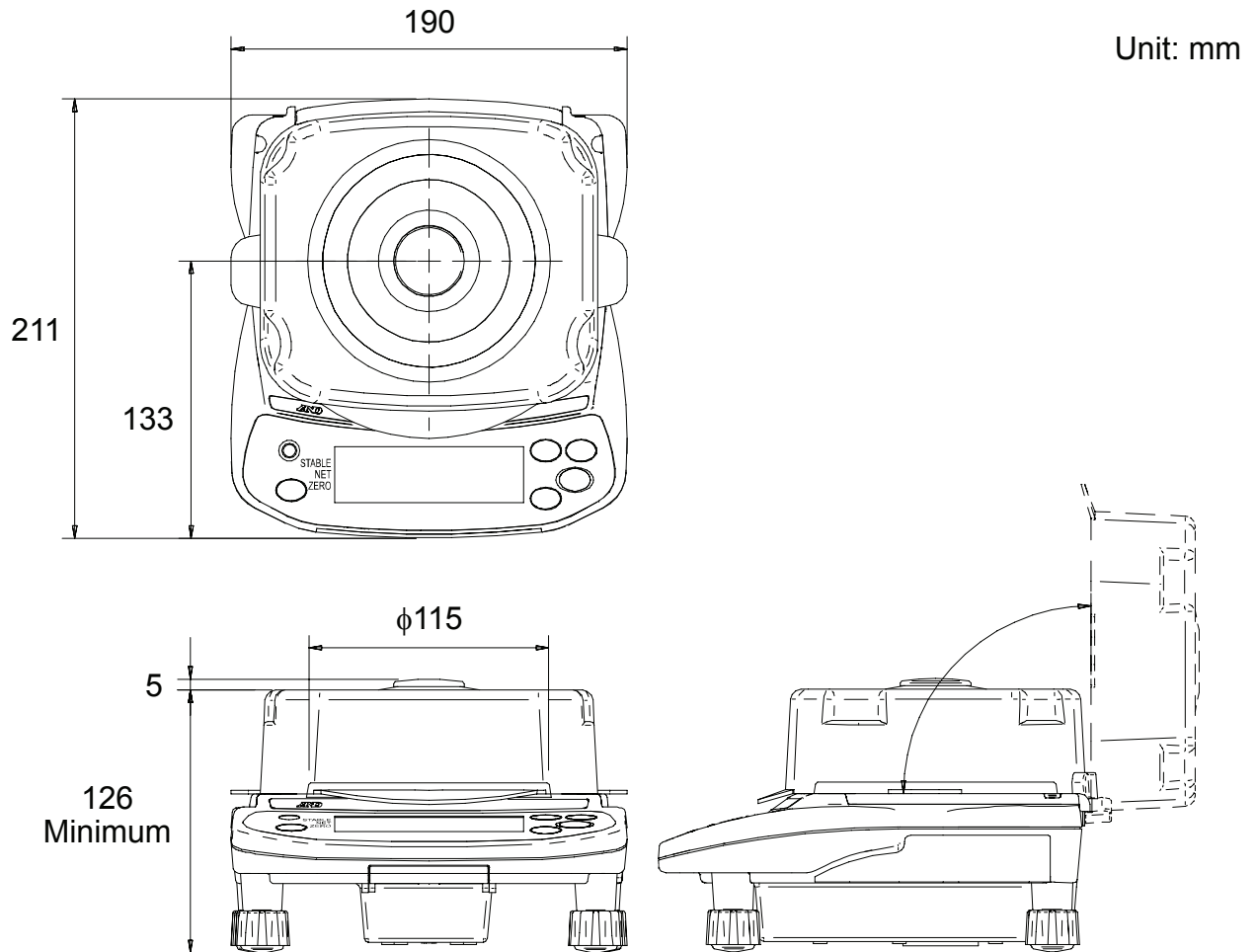

13. GRAVITY ACCELERATION MAP

Values Of Gravity At Various Locations

Amsterdam	9.813 m/s ²
Athens	9.807 m/s ²
Auckland NZ	9.799 m/s ²
Bangkok	9.783 m/s ²
Birmingham	9.813 m/s ²
Brussels	9.811 m/s ²
Buenos Aires	9.797 m/s ²
Calcutta	9.788 m/s ²
Cape Town	9.796 m/s ²
Chicago	9.803 m/s ²
Copenhagen	9.815 m/s ²
Cyprus	9.797 m/s ²
Djakarta	9.781 m/s ²
Frankfurt	9.810 m/s ²
Glasgow	9.816 m/s ²
Havana	9.788 m/s ²
Helsinki	9.819 m/s ²
Kuwait	9.793 m/s ²
Lisbon	9.801 m/s ²
London (Greenwich)	9.812 m/s ²
Los Angeles	9.796 m/s ²
Madrid	9.800 m/s ²

Manila	9.784 m/s ²
Melbourne	9.800 m/s ²
Mexico City	9.779 m/s ²
Milan	9.806 m/s ²
New York	9.802 m/s ²
Oslo	9.819 m/s ²
Ottawa	9.806 m/s ²
Paris	9.809 m/s ²
Rio de Janeiro	9.788 m/s ²
Rome	9.803 m/s ²
San Francisco	9.800 m/s ²
Singapore	9.781 m/s ²
Stockholm	9.818 m/s ²
Sydney	9.797 m/s ²
Taichung	9.789 m/s ²
Tainan	9.788 m/s ²
Taipei	9.790 m/s ²
Tokyo	9.798 m/s ²
Vancouver, BC	9.809 m/s ²
Washington DC	9.801 m/s ²
Wellington NZ	9.803 m/s ²
Zurich	9.807 m/s ²

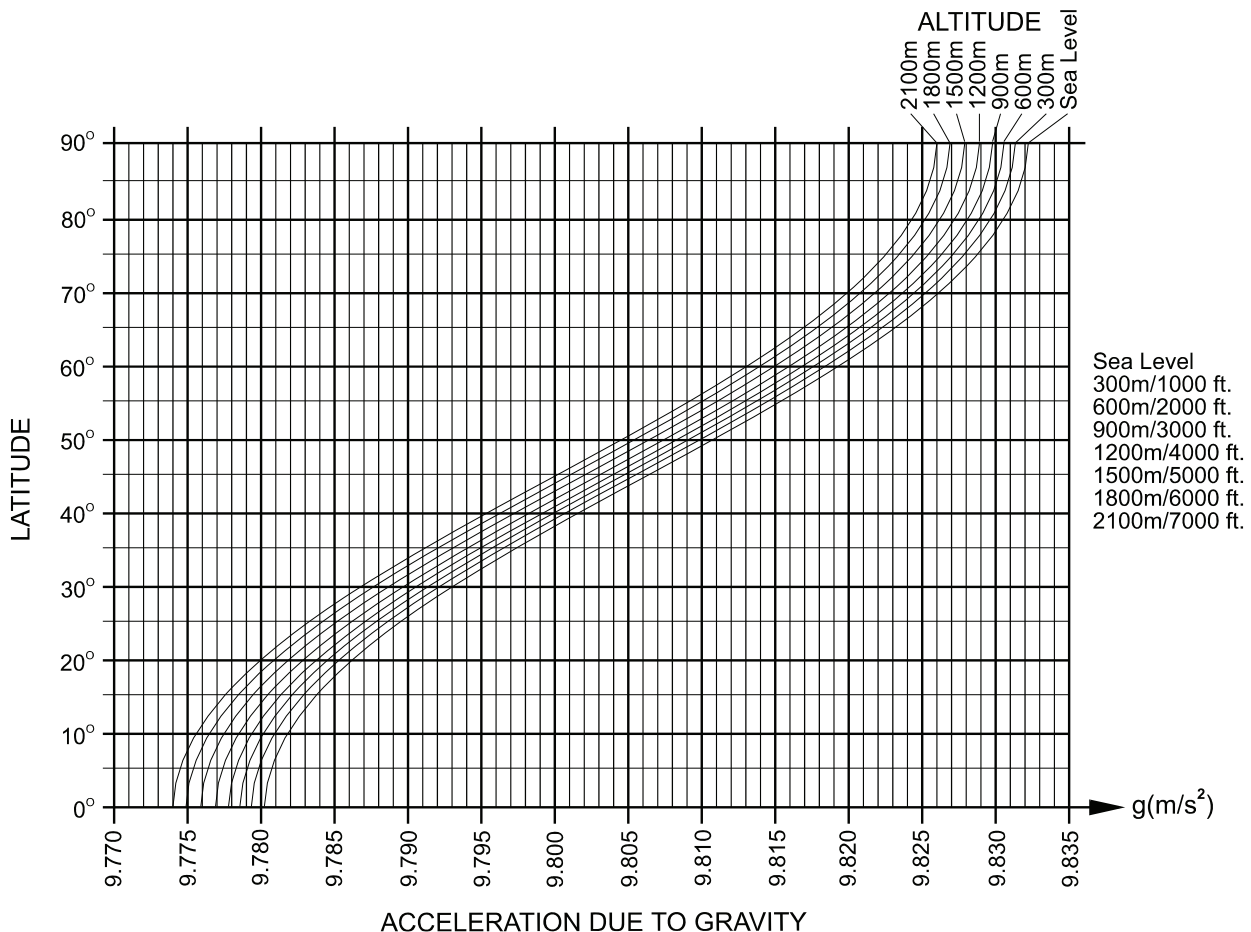

World Map

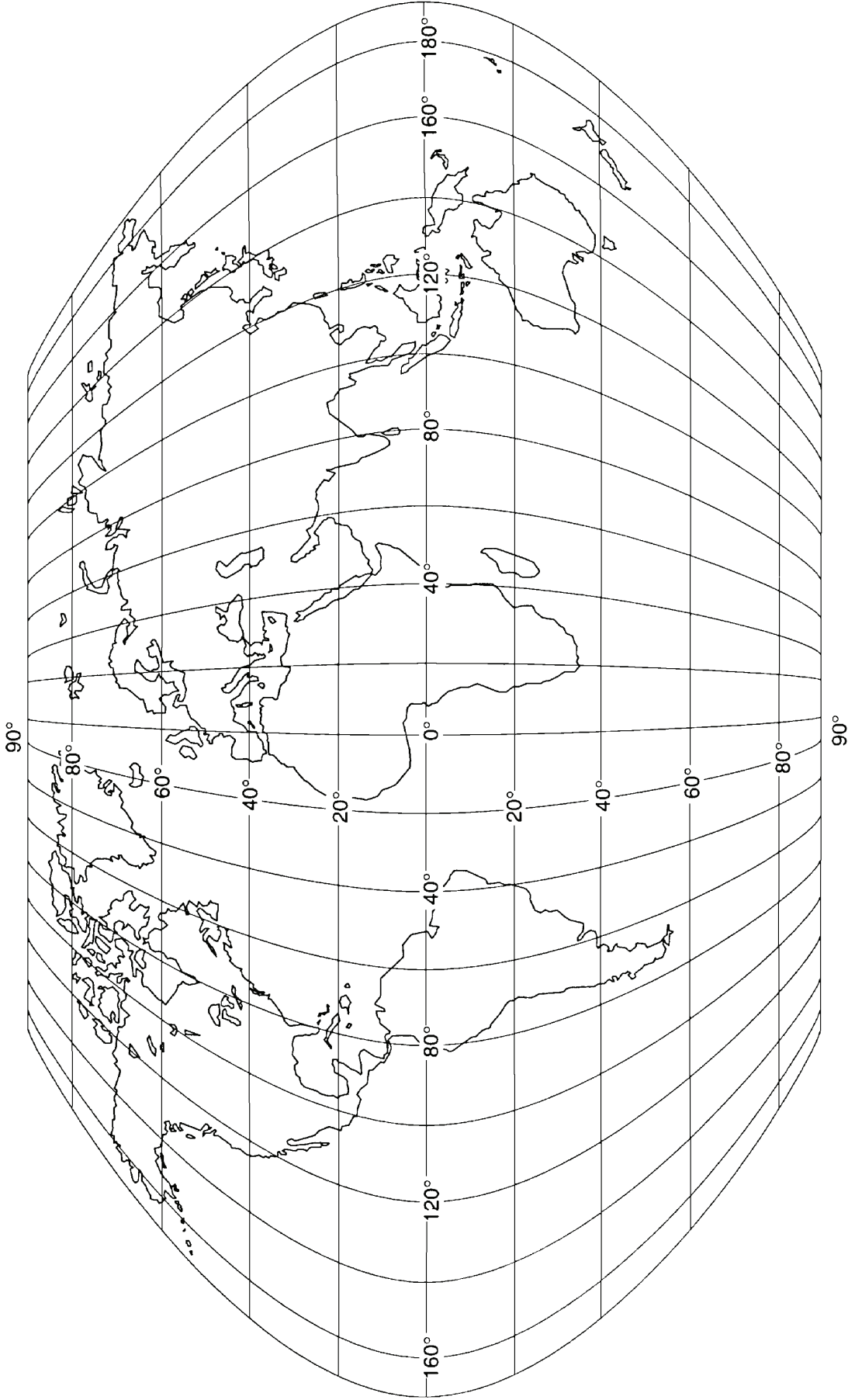



A&D Company, Limited

3-23-14 Higashi-Ikebukuro, Toshima-ku, Tokyo 170-0013, JAPAN

Telephone: [81] (3) 5391-6132

Fax: [81] (3) 5391-6148

A&D ENGINEERING, INC.

1756 Automation Parkway, San Jose, California 95131, U.S.A.

Telephone: [1] (408) 263-5333

Fax: [1] (408) 263-0119

A&D INSTRUMENTS LIMITED

Unit 24/26 Blacklands Way, Abingdon Business Park, Abingdon, Oxfordshire OX14 1DY United Kingdom

Telephone: [44] (1235) 550420

Fax: [44] (1235) 550485

A&D AUSTRALASIA PTY LTD

32 Dew Street, Thebarton, South Australia 5031, AUSTRALIA

Telephone: [61] (8) 8301-8100

Fax: [61] (8) 8352-7409

A&D KOREA Limited

한국에이.엔.디(주)

대한민국 서울시 영등포구 여의도동 36-2 맨하탄 빌딩 8층 우편 번호 150-749

(Manhattan Building 8th Floor, 36-2 Yoido-dong, Youngdeungpo-gu, Seoul, 150-749 Korea)

전화: [82] (2) 780-4101

팩스: [82] (2) 782-4280

OOO A&D RUS

ООО "Эй энд Ди Рус"

121357, Российская Федерация, г.Москва, ул. Вереysкая, дом 17

(Business-Center "Vereyskaya Plaza-2" 121357, Russian Federation, Moscow, Vereyskaya Street 17)

тел.: [7] (495) 937-33-44

факс: [7] (495) 937-55-66

A&D INSTRUMENTS INDIA PRIVATE LIMITED

ऐ&डी इन्स्ट्रूमेंट्स इण्डिया प्रा० लिमिटेड

509, उद्योग विहार, फेस -5, गुडगांव - 122016, हरियाणा, भारत

(509, Udyog Vihar, Phase-V, Gurgaon - 122 016, Haryana, India)

फोन : 91-124-4715555

फैक्स : 91-124-4715599