

680 Synergy Plus

Digital Weight Indicator

Technical Manual



An ISO 9001 registered company
© Rice Lake Weighing Systems. All rights reserved.

Rice Lake Weighing Systems® is a registered trademark of
Rice Lake Weighing Systems.
All other brand or product names within this publication are trademarks or
registered trademarks of their respective companies.

All information contained within this publication is, to the best of our knowledge, complete and accurate at the time of publication. Rice Lake Weighing Systems reserves the right to make changes to the technology, features, specifications and design of the equipment without notice.

The most current version of this publication, software, firmware and all other product updates can be found on our website:

www.ricelake.com

Contents

1.0	Introduction	1
1.1	Safety	1
1.2	Operating Modes	2
1.3	Option Card	2
2.0	Installation	3
2.1	Unpacking	3
2.1.1	Product Dimensions	3
2.2	Mounting Instructions	4
2.3	Backplate Removal	5
2.4	Cable Connections	5
2.4.1	Cable Shield Grounding	6
2.4.2	Torque Ratings	7
2.4.3	Load Cell Cables	7
2.4.4	RS-232 Serial Communications	7
2.4.5	RS-485/422 Serial Communications	7
2.4.6	Digital I/O	8
2.4.7	Micro USB Device Communications	8
2.4.8	Ethernet	9
2.4.9	Option Card Port	10
2.5	CPU Board	10
2.6	Backplate Attachment	10
2.7	Sealing the Indicator (Optional)	11
2.8	Parts Kit Components	11
2.9	Replacement Parts	12
3.0	Operation	14
3.1	Front Panel	14
3.2	LED Annunciators	15
3.3	General Navigation	15
3.3.1	Numeric Value Entry	15
3.3.2	Alphanumeric Entry	16
3.4	General Indicator Operation	16
3.4.1	Zero Scale	16
3.4.2	Toggle Units	16
3.4.3	Toggle Gross/Net Mode	16
3.4.4	Acquire Tare	16
3.4.5	Remove Stored Tare Value	17
3.4.6	Preset Tare (Keyed Tare)	17
3.4.7	Display a Stored Tare	17
3.4.8	Clear a Stored Tare	17
3.4.9	View Audit Trail Counters	18
3.4.10	View Legally Relevant Version	18
3.4.11	Display Accumulator	18
3.4.12	Print Accumulator	19
3.4.13	Clear Accumulator	19
3.4.14	Print Ticket	19



Technical training seminars are available through Rice Lake Weighing Systems. Course descriptions and dates can be viewed at www.ricelake.com/training or obtained by calling 715-234-9171 and asking for the training department.

Contents

3.4.15	Enter New Unit ID	20
3.4.16	View and Edit Time Value	20
3.4.17	View and Edit Date Value	20
3.4.18	View Configured Setpoint Values	21
3.4.19	Reset Configuration	21
4.0	Configuration	22
4.1	Setup Switch	22
4.1.1	Audit Jumper	22
4.2	Main Menu	23
4.3	Audit Menu	23
4.4	Setup Menu	24
4.4.1	Setup – Configuration Menu	24
4.4.2	Setup – Format Menu	26
4.4.3	Setup – Calibration Menu	26
4.4.4	Setup – Communication Menu	27
4.4.5	Setup – Program Menu	31
4.4.6	Setup – Print Format Menu	33
4.4.7	Setup – Stream Format Menu	34
4.4.8	Setup – Setpoints Menu	35
4.4.9	Setup – Digital I/O Menu	38
4.4.10	Setup – Analog Output Menu	39
4.5	Accumulator Menu	39
4.6	Tare Menu	39
5.0	Calibration	40
5.1	Front Panel Calibration	40
5.1.1	Span Calibration	40
5.1.2	Linear Calibration	41
5.2	Alternative Zero Calibrations	41
5.2.1	Last Zero	41
5.2.2	Temporary Zero	41
5.2.3	Rezero	41
5.3	EDP Command Calibration	42
6.0	Revolution®	43
6.1	Connecting to the Indicator	43
6.2	Saving and Transferring Data	43
6.2.1	Saving Indicator Data to a Personal Computer	43
6.2.2	Downloading Configuration Data from PC to Indicator	43
6.3	Updating Firmware	43
7.0	EDP Commands	44
7.1	Key Press Commands	44
7.2	Reporting Commands	45
7.3	Reset Configuration Command	45
7.4	Parameter Setting Commands	46
7.5	EDP Setting Commands	47



Rice Lake continually offers web-based video training on a growing selection of product-related topics at no cost. Visit www.ricelake.com/webinars

Contents

7.6	Internet Setting Commands	48
7.7	Stream Setting Commands	48
7.8	Feature Commands	49
7.9	Regulatory Commands	49
7.10	Setpoint Commands	50
7.11	Print Format Commands	51
7.12	Digital I/O Commands	51
7.13	Analog Output Commands	51
7.14	Weigh Mode Commands	52
7.15	Batching Control Commands	52
8.0	Print Formatting	53
8.1	Print Formatting Tokens	53
8.2	Customizing Print Formats	54
8.2.1	Using the Front Panel	54
9.0	Setpoints	55
9.1	Batch and Continuous Setpoints	55
9.2	Batching Examples	57
9.2.1	Example 1	57
9.2.2	Example 2	58
10.0	Maintenance	60
10.1	Maintenance Checkpoints	60
10.2	Field Wiring	60
10.3	Troubleshooting Tips	60
10.4	Battery Replacement	61
10.5	Board Replacement	61
11.0	Appendix	62
11.1	Error Messages	62
11.1.1	Displayed Error Messages	62
11.2	ZZ EDP Command	62
11.3	Continuous Data (Stream) Output Formats	63
11.3.1	Rice Lake Weighing Systems Stream Format (RLWS)	63
11.3.2	Cardinal Stream Format (cardnal)	63
11.3.3	Avery Weigh-Tronix Stream Format (wtronix)	64
11.3.4	Mettler Toledo Stream Format (toledo)	64
11.4	Local/Remote Operation	65
11.5	Audit Trail Support	65
11.6	Conversion Factors for Secondary Units	65
11.7	Digital Filtering	65
11.7.1	Digital Rolling Average Filter (AVGONLY)	65
11.7.2	Adaptive Filter (ADPONLY)	66
11.7.3	Damping Filter (DMPONLY)	67
11.8	Regulatory Mode Functions	68
11.9	ASCII Character Chart	69
11.10	Front Panel Display Characters	70



Technical training seminars are available through Rice Lake Weighing Systems. Course descriptions and dates can be viewed at www.ricelake.com/training or obtained by calling 715-234-9171 and asking for the training department.

Contents

12.0 Compliance	71
13.0 Specifications	72



Rice Lake continually offers web-based video training on a growing selection of product-related topics at no cost. Visit www.ricelake.com/webinars

1.0 Introduction

This manual is intended for use by service technicians responsible for installing and servicing 680 digital weight indicators. Configuration and calibration of the indicator can be accomplished using the Revolution® configuration utility or the indicator front panel keys. See [Section 4.0 on page 22](#) and [Section 5.0 on page 40](#) for information about configuration and calibration.



Manuals and additional resources are available from the Rice Lake Weighing Systems website at www.ricelake.com
Warranty information can be found on the website at www.ricelake.com/warranties

1.1 Safety

Safety Signal Definitions:



DANGER Indicates an imminently hazardous situation that, if not avoided, will result in death or serious injury. Includes hazards that are exposed when guards are removed.



WARNING Indicates a potentially hazardous situation that, if not avoided, could result in serious injury or death. Includes hazards that are exposed when guards are removed.



CAUTION Indicates a potentially hazardous situation that, if not avoided, could result in minor or moderate injury.



IMPORTANT Indicates information about procedures that, if not observed, could result in damage to equipment or corruption to and loss of data.

General Safety



Do not operate or work on this equipment unless this manual has been read and all instructions are understood. Failure to follow the instructions or heed the warnings could result in injury or death. Contact any Rice Lake Weighing Systems dealer for replacement manuals.



Failure to heed could result in serious injury or death.

Some procedures described in this manual require work inside the indicator enclosure. These procedures are to be performed by qualified service personnel only.

Ensure the power cord is disconnected from the outlet before opening the unit.

Do not allow minors (children) or inexperienced persons to operate this unit.

Do not operate without the enclosure completely assembled.

Do not use for purposes other than weight taking.

Do not place fingers into slots or possible pinch points.

Do not use this product if any of the components are cracked.

Do not exceed the rated specification of the unit.

Only connect unit to equipment certified to IEC 60950, IEC 62368, IEC 61010 or similar.

Do not make alterations or modifications to the unit.

Do not remove or obscure warning labels.

Do not use solvents or aggressive substances to clean the indicator.

Do not submerge.

1.2 Operating Modes

Weigh Mode

Weigh mode is the default mode of the indicator. The indicator displays gross or net weights as required, using the annunciators to indicate scale status and the type of weight value displayed.

User Mode

User mode is accessible by pressing  on the front panel. The indicator displays the audit, accumulator, tare and version menus when in user mode.

Setup Mode

Most of the procedures described in this manual, including calibration, require the indicator to be in setup mode.

See [Section 4.0 on page 22](#) for the procedure to enter setup mode and the parameters available.

1.3 Option Card

The 680 has a single option card slot which can support the Synergy Series Single Analog Output option card (PN 195084). The option card kit includes instructions for installation and setup.

2.0 Installation

This section describes procedures for connecting power, load cells, digital I/O and data communication cables to a 680 indicator. An assembly drawing and parts list are included for the service technician.



*Risk of electrical shock.
Risque de choc.*

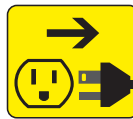

*Disconnect power before servicing.
Débranchez l'alimentation avant l'entretien.*



Risk of explosion if battery is replaced by an incorrect type. Dispose of used batteries according to state and local regulations.



Risque d'explosion si la batterie est remplacée par un type incorrect. Mettre au rebut les batteries usagées selon les règlements d'état et locaux.

Use anti-static protection for grounding and to protect components from electrostatic discharge (ESD) when working inside the 680 enclosure.

Procedures requiring work inside the 680 must be performed by qualified service personnel only.

The electric receptacle to the 680 must be easily accessible.

2.1 Unpacking

Immediately after unpacking, visually inspect the 680 to ensure all components are included and undamaged. The shipping carton contains the indicator, this manual and a parts kit (Section 2.9 on page 12). If parts were damaged in shipment, notify Rice Lake Weighing Systems and the shipper immediately.

2.1.1 Product Dimensions

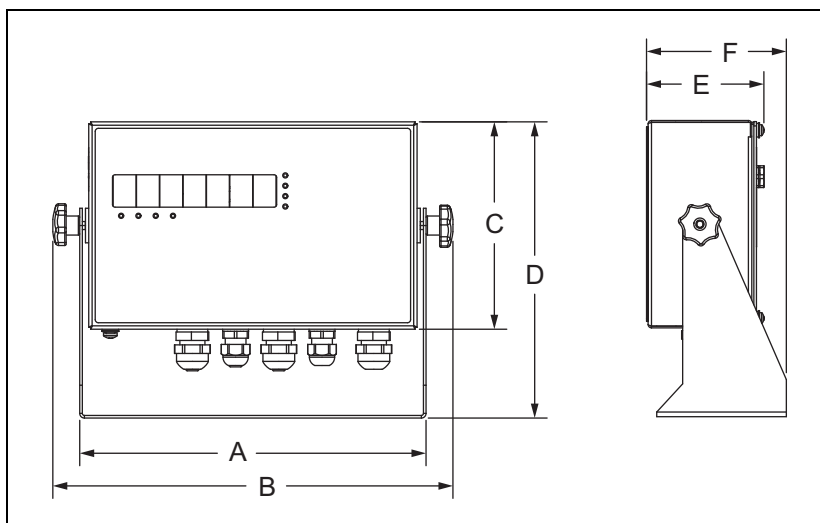

Figure 2-1. Product Diagram

A	B	C	D	E	F
10.02" (254.5 mm)	11.58" (294.1 mm)	6.00" (152.4 mm)	8.57" (217.7 mm)	3.40" (86.4 mm)	4.05" (102.9 mm)

Table 2-1. Product Dimensions

2.2 Mounting Instructions

The 680 includes a universal mount stand. The stand can be mounted on a wall, tabletop or a flat surface.

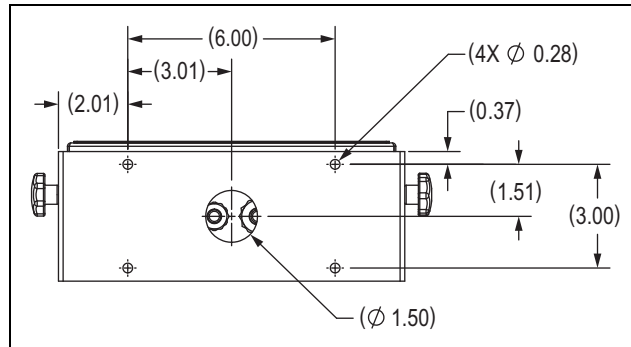

Figure 2-2. Mounting Dimensions



Note The universal mount stand comes attached to the 680. Rice Lake Weighing Systems recommends removing the 680 from the stand prior to mounting.



Figure 2-3. Mounting the Indicator

1. Using the mount as a template, mark the screw locations.
2. Drill holes for the screws.
3. Secure the universal mount using the appropriate length 1/4" or M6 hardware (not included).
4. Reattach the 680 to the universal mount stand.



Note The parts kit includes rubber grommets to insert into the four screw holes of the universal mount stand for a non-mounted application.

2.3 Backplate Removal

Remove the backplate of the 680 to connect cables and to gain access to the 680 board and power supply.

WARNING Before opening the unit, ensure the power cord is disconnected from the power outlet.

1. Place the 680 face-down on an anti-static work mat.
2. Remove the screws holding the backplate to the enclosure.
3. Lift the backplate away from the enclosure and disconnect the ground wire from the backplate.

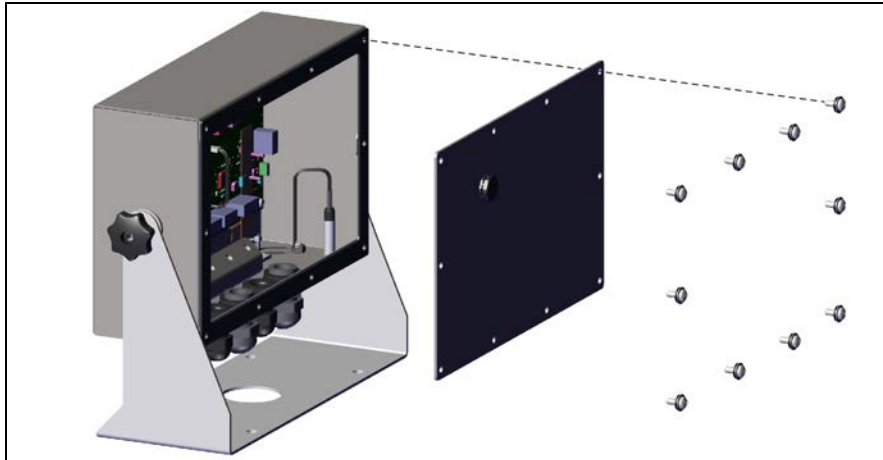

Figure 2-4. Removing the Backplate



Note

The 680 ships with only four screws securing the backplate. The remaining backplate screws are included in the parts kit. For reassembly, torque backplate screws to 15 in-lb (1.7 N-m).

2.4 Cable Connections

The 680 provides five cord grips at the bottom of the enclosure for cabling into the indicator. One of the cord grips is used for the power supply and the other four are used to accommodate the load cell cable and the serial, digital inputs and outputs, Ethernet, micro USB or the optional analog output communications cables. Three of the four free cord grips come with a plug installed to prevent moisture from entering the enclosure. Depending on the application, remove the plugs from cord grips to be used and install cables as required. The recommended cable strip length is 0.25" (7 mm) for all 680 connectors. See [Figure 2-5](#) for the recommended assignments for the 680 cord grips.

WARNING Only connect unit to equipment certified to IEC 60950, IEC 62368, IEC 61010 or similar.

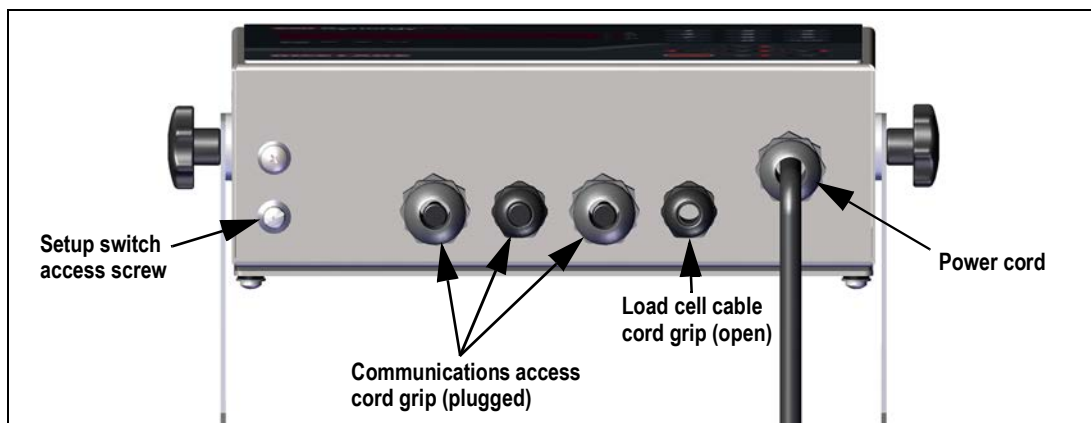

Figure 2-5. Recommended Cord Grip Assignments

IMPORTANT

Do not have open/bare wires outside of the enclosure. Make sure no stripped portion of cable is on the outside of the cord grips.

2.4.1 Cable Shield Grounding

Except for the power cord, all cables routed through the cord grips must be shield grounded against the enclosure.

- Use hardware provided in the parts kit to install shielding clamps on the grounding bracket at the bottom of the enclosure
- Install only the necessary amount of shielding clamps for the cord grips to be used
- Remove the insulated jackets and shielding per the following instructions

Shielding Procedure

1. Install the shielding clamps on the grounding rail using the clamp screws. Finger tighten the screws at this time.
2. Route the cables through the cord grips and the shielding clamps to determine the cable lengths required to reach the appropriate cable connectors.
3. Mark cables to remove the insulated jacket as described below for [Foil Shielded Cables](#) and [Braid Shielded Cables](#).

Foil Shielded Cables

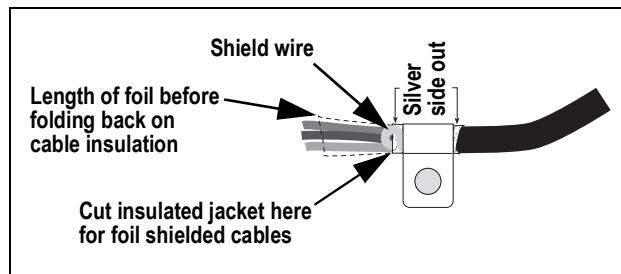

Figure 2-6. Foil Shielded Cable

1. Strip the insulated jacket and foil 1/2" (15 mm) past the shielding clamp.
2. Strip another 1/2" of the insulated jacket, leaving the foil shielding exposed.
3. Fold the foil shielding back on the cable where the cable passes through the clamp.
4. Ensure the silver (conductive) side of the foil is turned outward.
5. Wrap the shield wire around the cable, ensuring it contacts the foil where the cable passes through the clamp.
6. Torque the shielding clamp screw to 10 in-lb (1.1 N-m), ensuring the clamp is around the cable and contacting the shield wire.

Braid Shielded Cables

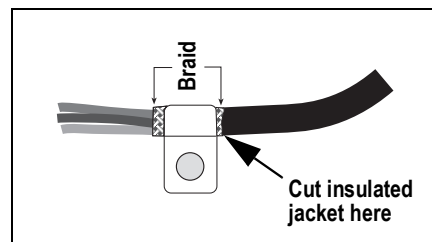

Figure 2-7. Braid Shielded Cable

1. Strip the insulated jacket and braided shielding from a point just past the shielding clamp.
2. Strip another 1/2" (15 mm) of the insulated jacket, leaving the braid exposed where the cable passes through the clamp.
3. Torque the shielding clamp screw to 10 in-lb (1.1 N-m), ensuring the clamp is contacting the braided shielding of the cable.

2.4.2 Torque Ratings

Refer to [Table 2-2](#) throughout installation and use of product to maintain proper torque ratings for 680 components.

Component	Torque Rating
Backplate Screw	15 in-lb (1.7 N-m)
Setup Screw	10 in-lb (1.1 N-m)
Cord Grip Nut (to enclosure)	33 in-lb (3.7 N-m)
Cord Grip Dome Nut (around cable)	22 in-lb (2.5 N-m)

Table 2-2. Component Torque Ratings

2.4.3 Load Cell Cables

To attach the cable from a load cell or junction box, route cable to the J1 connector ([Section 2.5 on page 10](#)). Connector for the cable is included in the parts kit. See [Table 2-3](#) for wiring the load cell cable from the load cell or junction box to connector.



A ferrite from the parts kit must be applied to the load cell cable within 1" (25 mm) of the load cell. The cable must be sent through the ferrite twice.

Connector	Pin	Function
J1	1	+SIG
	2	-SIG
	3	+SENSE
	4	-SENSE
	5	+EXC
	6	-EXC

Table 2-3. J1 Pin Assignments (Load Cell)



For a 4-wire installation leave pins 3 and 4 empty on the connector.

For a 6-wire installation set the SENSE parameter to 6-WIRE in the CONFIG menu ([Section 4.4.1 on page 24](#)).

2.4.4 RS-232 Serial Communications

The J3 connector ([Section 2.5 on page 10](#)) is intended to provide a connection point for the RS-232 serial communications. Two RS-232 ports are available. See [Table 2-4](#) for the pin assignments for the J3 connector.

Connector	Pin	RS232-1	RS232-2
J3	1	GND	-
	2	RX1	-
	3	TX1	-
	4	-	GND
	5	-	RX2
	6	-	TX2

Table 2-4. J3 Pin Assignments (RS-232)

2.4.5 RS-485/422 Serial Communications

The J4 connector ([Section 2.5 on page 10](#)) is intended to provide a connection point for the RS-485/422 serial communications. See [Table 2-5](#) for the pin assignments for the J4 connector.

Connector	Pin	RS485	422/485 Adapter
J4	1	GND	GND
	2	RXB	TDA(-)
	3	RXA	TDB(+)
	4	TXZ	RDA(-)
	5	TXY	RDB(+)

Table 2-5. J4 Pin Assignments (RS-485/422)



For transmit connections TXZ = TDB and TXY = TDA.

2.4.6 Digital I/O

The Digital I/O port, J5 connector (Section 2.5 on page 10) is intended to be connected to both digital inputs and outputs.

Digital inputs can be set to provide many functions, including most keypad functions except MENU. Digital inputs are active low (0 VDC) and inactive high (5 VDC). Use the Digital I/O menu to configure the digital inputs.

Digital outputs are used to control relays which drive other equipment. Outputs are designed to sink, rather than source current. Each output is an open collector circuit, capable of sinking 20 mA when active. Digital outputs are active when low or at 0 VDC, with reference to the 5 VDC supply.

Use the Digital I/O menu to set the function of the Digital I/O pins to OUTPUT and then use the Setpoints menu to configure the digital outputs. See Table 2-6 for the pin assignments for the J5 connector.

Connector	Pin	Signal
J5	1	5 VDC, 250 mA max
	2	GND
	3	DIO1
	4	DIO2
	5	DIO3
	6	DIO4

Table 2-6. J5 Pin Assignments (Digital I/O)

2.4.7 Micro USB Device Communications

The Micro USB port, J7 connector (Section 2.5 on page 10), is intended to be connected to a PC only. It appears as a Virtual COM Port and is assigned a “COMx” designation. Applications communicate through the port like a standard RS-232 communications port.

The driver must be installed on the PC before the Micro USB device port can be used. With the PC and 680 powered on, connect a USB cable from the PC to the micro USB connector (J7) on the 680. The PC recognizes if a device has been connected, and attempts to install the driver needed to make it work. The driver can also be downloaded from the [Rice Lake website](#).



Note *If using Windows 7 or later and the PC is connected to the Internet, the operating system may be able to install the drivers automatically.*

When the individual drivers are installed, a new COM Port designation is assigned for each physical USB port the 680 is connected to on the PC.

For example, if the PC has two physical RS-232 COM Ports, they most likely are designated COM1 and COM2. When connecting the 680 to a USB port on the PC, it is assigned the next available port designation, or in this case, COM3. When plugging into the same physical USB port on the PC, the port designation is again COM3. If plugging into another physical USB port on the PC, it is assigned the next available designation, in this case COM4.

After the drivers are installed, use Windows® Device Manager to determine the COM Port designation which was assigned to the USB port, or open the application to be used with the 680, such as Revolution, to see which ports are available.

Configuration of the Micro USB port is done in the USBCOM sub-menu under PORTS in setup mode.

The port can be configured as either a demand port for EDP commands and printing, or as a data streaming port. Other settings include the termination character(s), echoes, responses, the end-of-line delay and whether or not the 680 displays a 'print' message when a print format sends data out the port.



Note *If a computer application has an open communications connection through the Micro USB device port and the physical cable connection is interrupted, a soft reset must be performed on the 680 or the power must be cycled to the 680; the connection in the computer application must be disconnected and then reconnected before it continues to communicate with the 680.*

For the Micro USB device port, it does not matter what the settings are for Baud, Data Bits, Parity and Stop Bits in the computer software. The port communicates in the same way regardless of these settings.

This port is not a host port and is not intended to be connected to other devices such as keyboards, memory sticks or printers.

2.4.8 Ethernet

The 680 features Ethernet TCP/IP 10Base-T/100Base-TX communication using the J8 connector ([Section 2.5 on page 10](#)), and can support two simultaneous connections, one as a server, the other as a client.

Through an Ethernet network, software applications can communicate with the 680 using the EDP command set ([Section 7.0 on page 44](#)), or data can be streamed continuously from the 680, or printed on demand.

The Ethernet port supports both DHCP and manual configuration of settings such as the IP and netmask. In addition, the TCP Port number, and the Default Gateway can be configured using the Ethernet sub-menu of the Ports setup menu. For more information on configuring the Ethernet port see [Section 4.4.4.3 on page 30](#).

Physical connection to the 680 Ethernet port can be made directly from a PC to the 680 (AdHoc Network), or through a network router or switch. The port supports auto-sensing MDI/MDIX cable configuration, allowing either straight-through or crossover cables to be used. See [Table 2-7](#) for the pin assignments for the J8 connector.

Connector	Pin	Signal
J8	1	TX+
	2	TX-
	3	RX+
	4	RX-

Table 2-7. J8 Pin Assignments (Ethernet)



Note When looking into the enclosure from the backside of the indicator, pin 1 of the J8 connector is at the bottom.

See [Table 2-8](#) and [Table 2-9](#) for the pin assignments when connecting a RJ45 Ethernet cable to the J8 connector. There are two Ethernet wire standards (T568A and T568B). If the type of cable is unknown, use the wiring option in [Table 2-8](#). The auto-sensing feature of the Ethernet port allows either of the wiring options to work. Trim the unused wires to get them out of the way.

RJ45 Cable Pin	Wire Color (T568A)	Wire Diagram (T568A)	10Base-T Signal 100Base-TX Signal	J8 Connector Pin
1	White/Green		Transmit+	1
2	Green		Transmit-	2
3	White/Orange		Receive+	3
4	Blue		Unused	NA
5	White/Blue		Unused	NA
6	Orange		Receive-	4
7	White/Brown		Unused	NA
8	Brown		Unused	NA

Table 2-8. Ethernet Cable Pin Assignments for T568A

RJ45 Pin #	Wire Color (T568B)	Wire Diagram (T568B)	10Base-T Signal 100Base-TX Signal	J8 Pin #
1	White/Orange		Transmit+	1
2	Orange		Transmit-	2
3	White/Green		Receive+	3
4	Blue		Unused	NA
5	White/Blue		Unused	NA
6	Green		Receive-	4
7	White/Brown		Unused	NA
8	Brown		Unused	NA

Table 2-9. Ethernet Cable Pin Assignments for T568B

2.4.9 Option Card Port

The 680 has a single option card slot which uses the J22 and J23 connectors (Section 2.5). Instructions to install or replace an option card is provided with the option card.

2.5 CPU Board

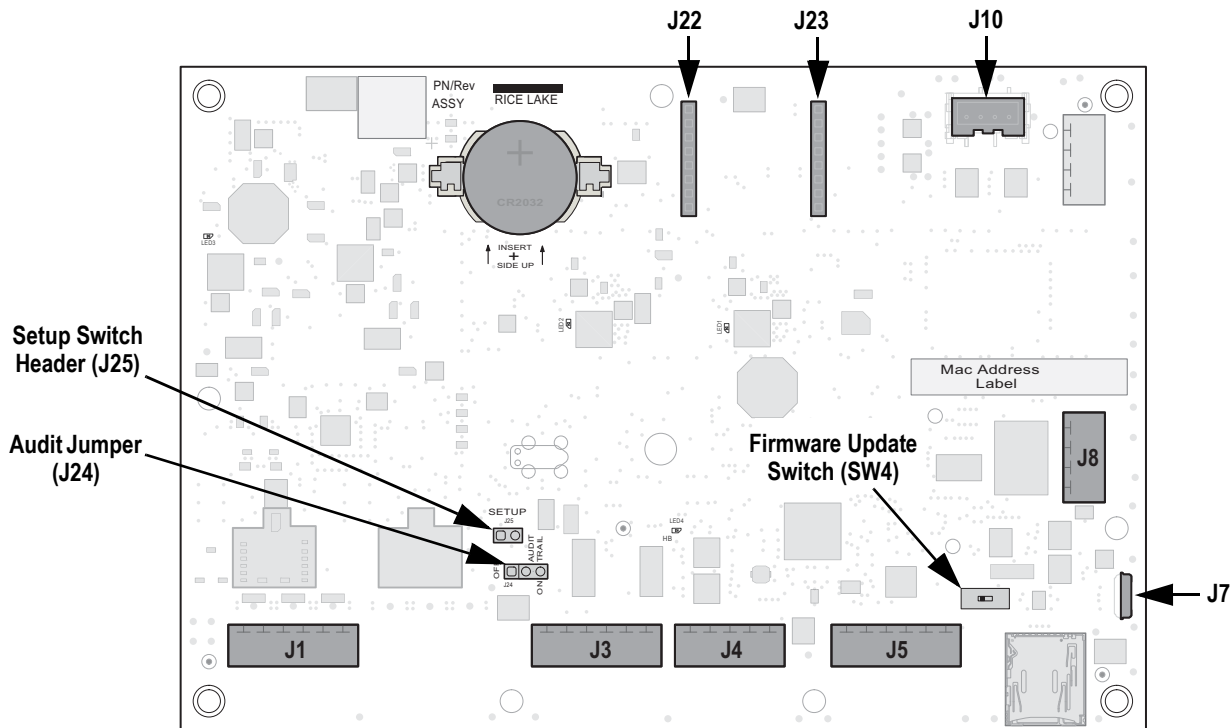

Figure 2-8. 680 CPU Board

Connectors

- Load Cell (J1)
- RS-485/422 (J4)
- Micro USB (J7)
- Power (J10)
- RS-232 1-2 (J3)
- Digital I/O (J5)
- Ethernet (J8)
- Option Slot (J22/J23)

2.6 Backplate Attachment

Once work inside of the enclosure is complete, reattach the backplate ground wire to the backplate. Position the backplate over the enclosure and install the ten backplate screws. Use the torque pattern in Figure 2-9 to prevent distorting the backplate gasket. Torque screws to 15 in-lb (1.7 N-m).

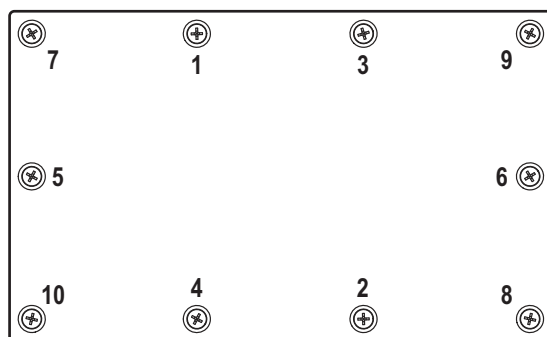

Figure 2-9. Backplate Torque Pattern



Note Torqued screws may become less tight as the gasket is compressed during the torque pattern; a second torque is required using the same pattern and torque value.

2.7 Sealing the Indicator (Optional)

Insert a lead wire seal through three fillister screws. This restricts access of the setup switch, electronics, electrical contacts and Legal for Trade configuration parameters.



Note

The audit jumper (J24) must be set to off to require pressing the setup switch for access to configuration parameters.

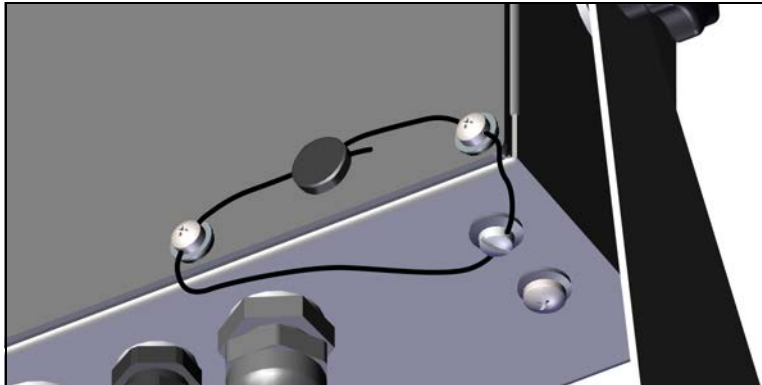

Figure 2-10. Sealing the Indicator – No Access

1. Reposition the two fillister head backplate screws to the lower right and lower right-center screws locations.
1. Torque the two backplate screws and setup screw as specified in [Section 2.4.2 on page 7](#).
2. Navigate the sealing wire through the fillister head screws on the backplate and the fillister head screw at the bottom of the enclosure, as shown in [Figure 2-10](#).
3. Seal the wire to secure.

2.8 Parts Kit Components

Part No.	Description	Qty
15631	Cable Tie, 3" Nylon	4
15650	Mount, Cable Tie 3/4"	2
193230	Screw, Mach M4 x 0.7 x 10 Phillips Pan Head SST	4
194219	Screw, Mach M4 x 0.7 x 10 Phillips Drilled Cheese Head SST	2
194446	Ferrite Core, Snap on Fair-rite	1
194488	Screw, Mach M4 x 0.7 x 6 Phillips Pan Head with External Tooth Washer SEMS	4
19538	Post Plug, Slotted Black Plastic Stem, 1/4 x 1, Seals Inside Cord Grip	3
195993	Connector, 6 Position Screw Terminal Pluggable 3.50 mm Black	3
195995	Connector, 4 Position Screw Terminal Pluggable 3.50 mm Black	1
195998	Connector, 5 Position Screw Terminal Pluggable 3.50 mm Black	1
30632	Bag, Plastic 5 x 8	1
42149	Bumper, Rubber Grommet 0.50 (OD) x 0.281 (ID)	4
53075	Clamp, Ground Cable Shield, Radius 0.078"	4
75062	Washer, Bonded Sealing #8 7/16 (0.4375) OD SST	6
94422	Label, Capacity 0.40 x 5.00	1

Table 2-10. Parts Kit (PN 194477) Components



Note

The recommended cable strip length is 0.25" (7 mm) for all 680 connectors.

2.9 Replacement Parts

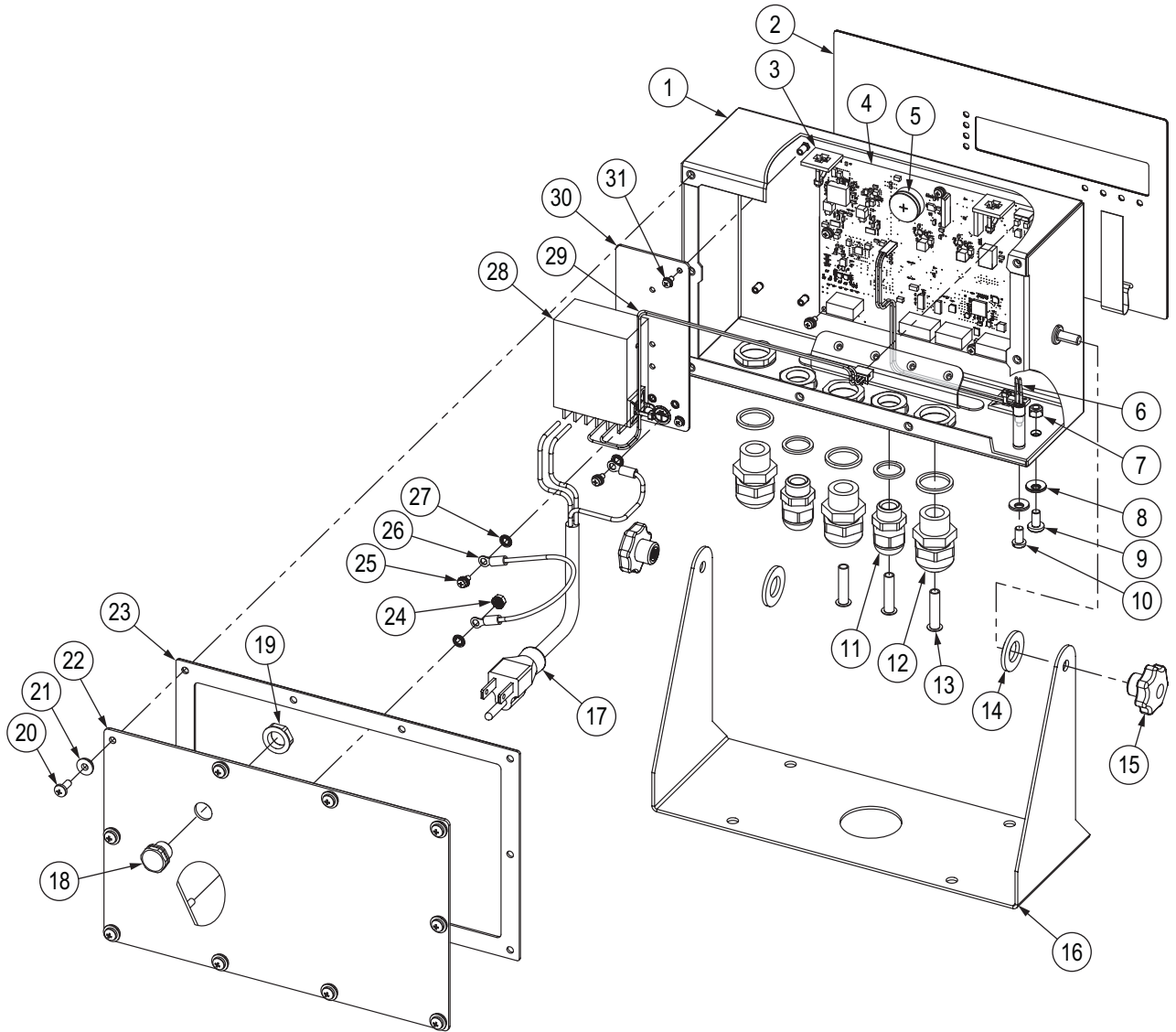

Figure 2-11. Replacement Parts Diagram

Item No.	Part No.	Description	Qty
1	190142	Enclosure, 680 Plus Indicator Multi-Segment LED Display	1
2	190230	Overlay, 680 Plus Indicator Membrane Switch with Numeric Keys	1
3	15650	Mount, Cable Tie 3/4"	4
	15631	Cable Tie, 3" Nylon	4
4	195684	680 Replacement CPU Board with Battery	1
	194487	Screw, Metric M3 x 6 SEMS Phillips Pan Head with External Tooth Washer	4
5	71408	Battery, CR2032 3 V Lithium Manganese Dioxide	1
6	193108	Setup Switch Assembly, Remote	1
7	187876	Nut, Lock M5 Nylon Insert A2 SST	1
8	46381	#10 Bonded Sealing Washer, 18-8 SST	2
9	150800	Screw, Mach M5-0.8 x 10 Pan Phillips SST	1
10	180861	Screw, Mach M5 x 0.8 x 10 mm Slotted Drilled Cheese Head SST	1
11	15626	Cord Grip, PG9	2
	30375	Seal Ring, PG9 Nylon	2
	15627	Lock Nut, PG9	2
12	68600	Cord Grip, PG11	3
	68599	Seal Ring, PG11 Nylon	3
	68601	Lock Nut, PG11	3
13	19538	Post, Slotted Black Seal 1/4 x 1, Cord Grip - Post Only	3
14	103988	Washer, Nylon 0.515-0.52 ID x 1.00 x 0.093-0.094 Thick White Nylon 6/6	2
15	180825	Knob, M6 x 1 Threaded 32 mm Diameter 7-Lobe Nylon ZN-Plated Steel	2
16	29635	Tilt Stand, SST	1
17	180842	Power Cord Assembly, NEMA 5-15 <i>NOTE: For Unit PN 193152 (AC - US) only</i>	1
	180850	Power Cord Assembly, Europe CEE7/7 <i>NOTE: For Unit PN 193153 (AC - EURO) only</i>	1
18	88733	Vent, Breather Sealed Gortex Membrane Black	1
19	88734	Nut, Breather Vent M12 x 1 Thread	1
20	193230	Screw, Mach M4 x 0.7 x 10 Phillips Pan Head SST	4
21	75062	#8 Bonded Sealing Washer, 7/16 OD SST	4
22	192562	Backplate, 680 Universal with Gore Vent Hole, No Options	1
23	84388	Gasket, Backplate	1
24	180826	Nut, KEP M4 x 0.7 External Tooth Lock Washer 18-8 SST	1
25	194488	Screw, Mach SEMS M4 x 0.7 x 6 Phillips Pan Head External Tooth Lock Washer	2
26	15601	Wire, Ground 6" with No. 8 Eye Connector	1
27	180856	Washer, M4 Internal Tooth SST	4
28	193281	Power supply, 12 V 15 W MeanWell RS-15-12 <i>NOTE: For AC units only</i>	1
29	193337	Cable Assembly, 680 Power Harness, 2 Position, Flying Lead	1
30	192439	Bracket, power supply MeanWell 15 and 25 Watt	1
31	194487	Screw, Metric M3 x 6 SEMS Phillips Pan Head with External Tooth Washer	5
-	194477	680 Indicator Parts Kit	1

Table 2-11. Replacement Parts

3.0 Operation

The front panel consists of a seven-segment display with seven 0.8" (20 mm) tall digits. A negative number displays as six digits plus the negative symbol. Front panel also includes 19 flat membrane panel, tactile feel buttons, which include six primary scale function buttons, a numeric keypad and a power button. There are eight LED annunciators for units and scale functions.

3.1 Front Panel

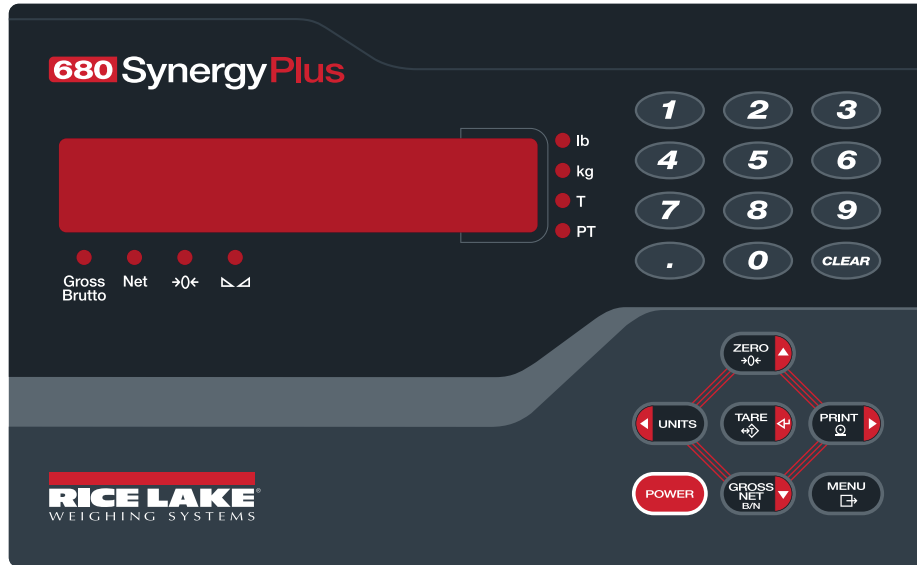

Figure 3-1. 680 Front Panel

Key	Function
	Turns the unit ON/OFF: If ON, press and hold for eight seconds to turn unit OFF If OFF, press and hold for two seconds to turn unit ON
	The Menu key is used to access user mode; See Section 4.1.1 on page 22 for more information on setting up the Menu key to access setup mode parameters
	Sets the current gross weight to zero, provided the amount of weight to be removed or added is within the specified zero range and the scale is not in motion; The zero band is defaulted to 1.9% of full scale, but can be configured for up to 100 percent of full scale; Also used as the up key to navigate menus
	Switches the weight display to an alternate unit; The alternate unit is defined in the Configuration menu, and could be kg, g, lb, oz, tn or t; Also used as the left key to navigate menus or to toggle to another digit when editing a value
	Sends on-demand print format out the configured port, provided the conditions for standstill are met; RS232-1 is the default print port; Also used as the right key to navigate menus or to toggle to another digit when editing a value
	Performs one of several predetermined Tare functions dependent on the mode of operation selected in the TARE FN parameter; Also acts as an enter key for numeric or parameter entry
	Switches the display mode from gross to net, or from net to gross; If a tare value has been entered or acquired, the net value is the gross weight minus the tare; Gross mode is represented by the Gross/Brutto annunciator; net mode is represented by the Net annunciator; Also used as the down key to navigate menus
	Clears current value in a numeric entry or clears the currently selected digit in an alphanumeric entry

Table 3-1. Buttons and Descriptions

3.2 LED Annunciators

The 680 display uses a set of eight LED annunciators to provide additional information about the value being displayed.

LED	Description
Gross Brutto	Gross/Brutto LED – Gross weight display mode (or Brutto in OIML mode)
Net	Net LED – Net weight display mode
→0←	The Center of Zero LED – Indicates the current gross weight reading is within +/- 0.25 display divisions of the acquired zero, or is within the center of zero band; A display division is the resolution of the displayed weight value, or the smallest incremental increase or decrease which can be displayed or printed
▢▢	Standstill LED – Scale is at standstill or within the specified motion band; Some operations, including zero, tare and print, can only be done when the standstill LED is on
lb	lb and kg LEDs:
kg	Displays which unit of measure is being used; lb and kg annunciators indicate the units associated with the displayed value; The displayed units can also be set to short tons (tn), metric tons (t), ounces (oz), grams (g) or none (no units information displayed); The lb and kg LEDs function as primary and secondary units annunciators; If neither primary nor secondary units are lb or kg, the lb annunciator is lit for primary units and kg is lit for secondary units
T	Tare LED – Indicates a push-button tare weight has been acquired and stored in memory
PT	Preset Tare LED – Indicates a preset tare weight has been keyed in or entered and stored in memory

Table 3-2. LED Annunciators

3.3 General Navigation

The front panel scale function buttons are also used to navigate through the menu structure.

- **UNITS** and **PRINT** move left and right (horizontally) in a menu level
- **ZERO** and **GROSS NET B/N** move up and down to different menu levels
- **TARE** enters a menu or parameter and selects/saves parameter settings or values
- **MENU** to access user mode, to leave a parameter without making changes, or to return to weigh mode
- Use the numeric keypad to enter a value and press **TARE** to accept the value ([Section 3.3.1](#))

3.3.1 Numeric Value Entry

Several parameters in the menu structure require the entry of a numeric value rather than the making of a selection.

Follow this procedure to enter a numeric value:

1. Press **GROSS NET B/N** or **TARE** to enter into a parameter. The current parameter value displays.
2. Press **CLEAR** to clear the current value.
3. Use the numeric keypad to enter a new value.
4. If necessary, press **GROSS NET B/N** to make the value negative.
5. Press **TARE** to save the new value. The next parameter in the menu displays.



Pressing **ZERO also saves the new value, but the indicator returns up to the current parameter, rather than to the next parameter in the menu.**

3.3.2 Alphanumeric Entry

Several parameters in the menu structure require the entry of an alphanumeric value rather than the making of a selection.



Note *The end of the alphanumeric character string is indicated by the “_.” character symbol.*

Follow this procedure to enter an alphanumeric value:

1. Press or to enter into the parameter. The current parameter entry displays.
2. Press or to move to the character to be edited.
3. Press to enter into the character options for the location at the far right of the display.
4. Press or to scroll through available character or use the numeric keypad to enter in the ASCII value of the intended character ([Section 11.9 on page 69](#)).
5. Press to select the currently displayed character. The selected character displays in the second display field.
6. Press to enter into the character options again for the next character.
7. Press again or press to clear the current character.
8. Repeat the previous steps until alphanumeric entry is complete.
9. Press to save the new entry.



Note *Press to leave the parameter without saving the changes.*

3.4 General Indicator Operation

Basic 680 operations are summarized below.

3.4.1 Zero Scale

1. In gross mode, remove all weight from the scale and wait for the LED to light.
2. Press . The LED lights to indicate the scale is zeroed.



Note *The scale must be stable and within the configured zero range for the scale to be zeroed. If the scale cannot be zeroed, see [Section 11.1.1 on page 62](#).*

3.4.2 Toggle Units

Press to toggle between primary and secondary units. The current unit LED is lit.

3.4.3 Toggle Gross/Net Mode







Net mode is available when a tare value has been entered or acquired (Net = Gross minus Tare). If tare has not been entered or acquired, the display remains in gross mode. The LED above Gross or Net indicate the current mode.

Press to toggle the display mode between gross and net.

3.4.4 Acquire Tare





1. Place a container on the scale and wait for the LED to light.
2. Press to acquire the tare weight of the container. The net weight displays and the Net LED and T LED light, confirming the tare value was entered.

3.4.5 Remove Stored Tare Value



1. Remove all weight from the scale and wait for the   LED to light. The display reads the negative tare value and the   LED is lit.
2. Press  to zero the scale, if needed.
3. Press  (or  in OIML mode). Display changes to gross weight and the Gross LED lights.

3.4.6 Preset Tare (Keyed Tare)















Tare mode must be set to keyed or both for the preset tare feature to function.

1. Remove all weight from the scale and wait for the   LED and   LED to light.
2. With the scale displaying zero weight, use the numeric keypad to enter the tare weight value and press .
3. The display changes to net weight and the Net LED and PT LED light, confirming the preset tare was entered.



























Note Press  again while the   LED is lit, or enter a keyed tare of zero to remove the preset tare value.

3.4.7 Display a Stored Tare

1. Press .    displays.
2. Press  or  until    displays.
3. Press .    displays.
4. Press . The stored tare value displays.
5. Press  twice to return to weigh mode.









If there is not a tare in the system, the value displayed is zero.

3.4.8 Clear a Stored Tare







1. Press .    displays.
2. Press  or  until    displays.
3. Press .    displays.
4. Press .    displays.
5. Press  or  to clear the stored tare value.   displays.
6. Press  or  to return the audit menu.
7. Press  to return to weigh mode.

3.4.9 View Audit Trail Counters









The audit trail calibration and configuration counters can be viewed in user mode.

1. Press . **AUDIT** displays.
2. Press . **LCU** displays.
3. Press . **CALLBR** displays.
4. Press . The audit trail calibration counter displays.
5. Press . **CALLBR** displays.
6. Press . **CONFIG** displays.
7. Press . The audit trail configuration counter displays.
8. Press  twice to return to weigh mode.











3.4.10 View Legally Relevant Version

1. Press . **AUDIT** displays.
2. Press . **LCU** displays.
3. Press . The legally relevant version displays.
4. Press  or  to return the audit menu parameters.
5. Press  twice to return to weigh mode.











3.4.11 Display Accumulator

1. Press . **AUDIT** displays.
2. Press  or  until **ACCUM** displays.
3. Press . **DISPACC** displays.
4. Press . The accumulator value displays.
5. Press  or  to return the accumulator menu parameters.
6. Press  to return to weigh mode.



3.4.12 Print Accumulator





1. Press . $\overline{A}Ud, t$ displays.
2. Press  UNITS or  until $\overline{A}CCUM$ displays.
3. Press . $\overline{d}, \overline{S}PACN$ displays.
4. Press . $\overline{P}r\overline{t}ACCUM$ displays.
5. Press  or  to print the accumulator value. $\overline{a}F$ displays.
6. Press  or  to return the accumulator menu parameters.
7. Press  to return to weigh mode.

3.4.13 Clear Accumulator

1. Press . $\overline{A}Ud, t$ displays.
2. Press  UNITS or  until $\overline{A}CCUM$ displays.
3. Press . $\overline{d}, \overline{S}PACN$ displays.
4. Press  UNITS. $\overline{C}LrACCUM$ displays.
5. Press  or  to clear the accumulator value. $\overline{a}F$ displays.
6. Press  or  to return the accumulator menu parameters.
7. Press  to return to weigh mode.







3.4.14 Print Ticket

1. Wait for the   LED to be lit.
2. Press  to send data to the configured port. The default print port is RS232-1 ([Section 2.4.4 on page 7](#)).

If the   LED is not lit and  is pressed, the print action only occurs if the scale comes out of motion within three seconds. If the scale stays in motion for over three seconds, the  press is ignored.







3.4.15 Enter New Unit ID

Entering a new Unit ID requires access to setup mode ([Section 4.1 on page 22](#)).

1. Press .
2. Press  to **AUDIT**.
3. Press  until display reads **UNIT ID**.
4. Press  to view the current value.
5. Edit the value using the keypad ([Section 3.3.1 on page 15](#)).
6. Press  when the value is correct.
7. Press  to return to weigh mode.

3.4.16 View and Edit Time Value

To view and edit the current time:







1. Press . **AUDIT** displays.
2. Press  multiple times until **TIME** displays.
3. Press  to view the current set time.
4. To edit the time value use the following method:
 - Press  to clear the current time
 - Use the numeric keypad to enter the new time value
 - Press  to accept the new time value once correct
5. Press  to return to weigh mode.



Note *Time is backed up by the internal battery and is not lost if the main power is interrupted. See [Section 4.4.5 on page 31](#) for time formatting options.*

3.4.17 View and Edit Date Value

To view and edit the current date:





1. Press . **AUDIT** displays.
2. Press  multiple times until **DATE** displays.
3. Press  to view the current set date.
4. To edit the date value use the following method:
 - Press  to clear the current date
 - Use the numeric keypad to enter the new date value and press  to accept the desired value
5. Press  to return to weigh mode.



Note *Date is backed up by the internal battery and is not lost if the main power is interrupted. See [Section 4.4.5 on page 31](#) for date formatting options.*

3.4.18 View Configured Setpoint Values







See [Section 9.0 on page 55](#) more information.

1. Press . $\overline{A}LUE$ displays.
2. Press  twice. $\overline{S}ETPt$ displays.
3. Press . The lowest configured setpoint number displays.
4. Press  to navigate to the desired setpoint number (1-8).











Note

Only configured setpoint numbers display. Displayed setpoints are read only unless access is set to on. See [Section 4.4.8 on page 35](#) for the complete setpoint menu.

5. Press . $\overline{A}LUE$ displays.
6. Press  again to view the current configured setpoint value.
7. To edit the setpoint value use the following method:
 - Press  to clear the current value
 - Use the numeric keypad to enter the new value and press  to accept it
 - Press  to accept the new value once correct
8. Press  to return to weigh mode.

3.4.19 Reset Configuration

1. Access setup mode by pressing the setup switch ([Figure 4-1 on page 22](#)). $\overline{C}ONFiG$ displays.
2. Press . $\overline{d}FLtEFt$ displays.
3. Press . $n0$ displays.
4. Press . $\overline{Y}ES$ displays.
5. Press  or  to reset the configuration setting. $n0$ displays.
6. Press  or . $n0$ displays again.
7. Press  to return to weigh mode.

4.0 Configuration

There are two types of configuration parameters in the 680, setup mode parameters (or Legal for Trade configuration) and user mode parameters (or non-legal configuration). Setup mode parameters are accessed by pressing the setup switch ([Section 4.1](#)). User mode parameters are accessed by pressing the menu button and do not require pressing the setup switch.

The following sections provide graphic representations of the 680 menu structures. Most menu diagrams are accompanied by a table which describes all parameters and parameter values associated with the menu. The factory default setting appears at the top of each column in bold type.

The audit, setpoints, accumulator, tare, time, date, Mac ID and version menus can be accessed by pressing .



The top-level setpoints menu displays the setpoint value of configured setpoints and is accessible with the menu button. Complete configuration of setpoints is under the setup menu and requires the setup switch for access.

The setup menu are accessed by pressing the setup switch ([Section 4.1](#)).



All weight related parameters must be configured prior to calibrating the unit.

4.1 Setup Switch

In order to configure the 680, it must be placed in setup mode with the setup switch. The setup switch is accessed through a small hole on the bottom of the enclosure. Remove the setup switch screw and insert a non-conductive tool into the access hole to press the setup switch.

IMPORTANT

Use caution when inserting the non-conductive tool into the enclosure. Insert the tool about 3/4" (19 mm), until the switch is engaged. Do not use excessive force which could damage the switch.

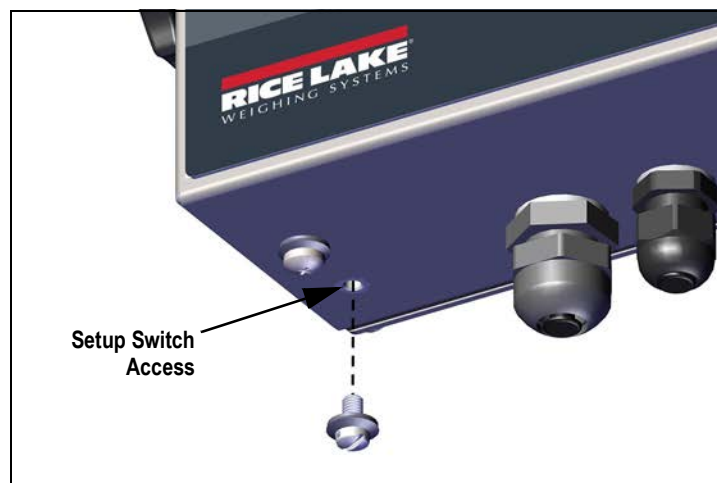

Figure 4-1. Setup Switch Access

When the 680 is placed in setup mode, the setup menu is accessed and $\square \square \square \square \square$ displays. See [Section 4.4 on page 24](#) for a detailed breakdown of this menu. Torque the setup switch screw to 10 in-lb (1.1 N-m) when reinserting.

4.1.1 Audit Jumper

The audit jumper (J24) turns setup mode access on and off. Access to setup mode is allowed without pressing the setup switch when the audit jumper is in the on position. Access to setup mode requires pressing the setup switch when the audit jumper is in the off position. See [Section 2.5 on page 10](#) for the location of the audit jumper on the CPU board.



In certain Legal for Trade applications it is necessary to seal the indicator to restrict access to the setup switch ([Section 2.7 on page 11](#)). Breaking of the seal terminates the Legal for Trade status of the indicator.

4.2 Main Menu



Figure 4-2. Main Menu

Menu	Description
AUDIT	Audit – Displays the legally relevant firmware version and allows access to view/print audit trail information; See Section 4.3
SETUP	Setup – Set configuration parameters for indicator (only accessible in setup mode); See Section 4.4 on page 24
SETPOINT	Setpoints – Displays the setpoint value of configured setpoints; Read only unless access parameter for the setpoint is set to ON; Setpoints are fully configurable in the setup menu while the indicator is in setup mode
ACCUM	Accumulator – Displays, prints and clears accumulated weight value; See Section 4.5 on page 39
TARE	Tare – Displays and clears stored tare value; See Section 4.6 on page 39
TIME	Time – Displays the time and allows the time to be edited (24-hour)
DATE	Date – Displays the date and allows the date to be edited
MAC ID	Mac ID – Displays the Mac ID (read only)
VER5	Version – Displays the installed firmware version number

Table 4-1. Main Menu Descriptions

4.3 Audit Menu

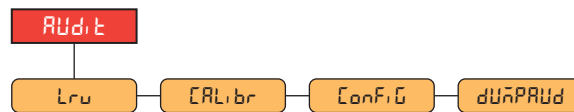

Figure 4-3. Audit Menu

Parameter	Description
LRV	LRV – Legally relevant firmware version
CALIBR	Calibration – Displays total number of calibration events (read only)
CONFIG	Configuration – Displays total number of configuration events (read only)
DUMPTRAIL	Dump Audit Trail – Prints the audit parameters to the configured port

Table 4-2. Audit Menu Descriptions

4.4 Setup Menu

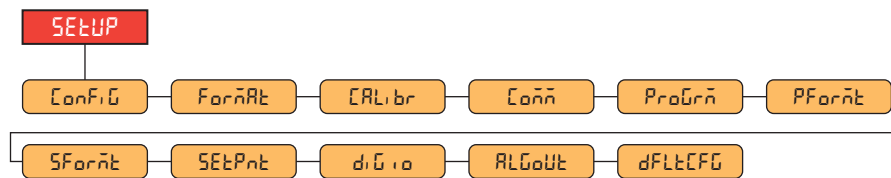

Figure 4-4. Setup Menu

Menu	Description
CONFIG	Configuration – See Section 4.4.1 on page 24 for menu structure and parameter descriptions of the Configuration menu
FORMAT	Format – See Section 4.4.2 on page 26 for menu structure and parameter descriptions of the Format menu
CALIBR	Calibration – See Section 4.4.3 on page 26 for menu structure and parameter descriptions of the Calibration menu
COMM	Communication – See Section 4.4.4 on page 27 for menu structure and parameter descriptions of the Communication menu
PROGRAM	Program – See Section 4.4.5 on page 31 for menu structure and parameter descriptions of the Program menu
PRINT	Print Format – See Section 4.4.6 on page 33 for menu structure and parameter descriptions of the Print Format menu
STREAM	Stream Format – See Section 4.4.7 on page 34 for menu structure and parameter descriptions of the Stream Format menu
SETPOINT	Setpoints – See Section 4.4.8 on page 35 for menu structure and parameter descriptions of the Setpoint menu
DIGIO	Digital I/O – See Section 4.4.9 on page 38 for menu structure and parameter descriptions of the Digital I/O menu
ANALOG	Analog Output – See Section 4.4.10 on page 39 for menu structure and parameter descriptions of the Analog Output menu
DEFAULT	Default Configuration – See Section 3.4.19 on page 21 for instructions to reset the configuration settings

Table 4-3. Setup Menu Descriptions

4.4.1 Setup – Configuration Menu

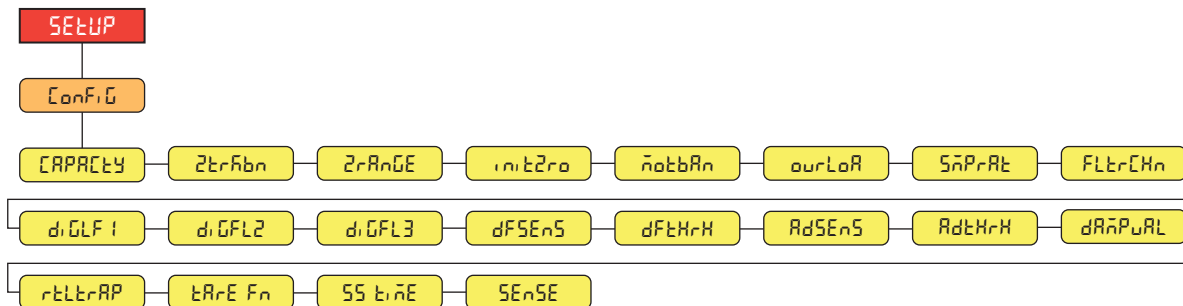

Figure 4-5. Setup – Configuration Menu

Menu	Description
CAPACITY	Capacity – Maximum rated capacity of the scale; <i>Enter value: 0.0000001–9999999.0, 10000.0 (default)</i>
ZTBND	Zero Track Band – Automatically zeros the scale when within the range specified, as long as the input is within the ZRNGE and scale standstill; When weight is within the zero band, the center of zero annunciator displays; Max legal value depends on local regulations; Specify the zero tracking band in ± display divisions; <i>Enter value: 0.0–100.0, 0.0 (default)</i>
ZRNGE	Zero Range – The total amount the scale can be zeroed; Zero range represents a percentage of capacity; The default value of 1.9 represents ±1.9% around the calibrated zero point, for a total range of 3.8%; A value of 0.0 prevents zeroing; Maximum legal value depends on local regulations; <i>Enter value: 0.0–100.0, 1.9 (default)</i>
INITZER	Initial Zero Range – When the indicator is turned on and the weight value is between the ± percent range specified in Calibrated Zero, the indicator automatically zeros off the weight; <i>Enter value: 0.0–100.0, 0.0 (default)</i>
MOTBND	Motion Band – Sets the level, in display divisions, at which scale motion is detected; If motion is not detected for the time defined by SS TRNE, the standstill symbol lights; Some operations, including print, tare, and zero, require the scale to be at standstill; Maximum legal value varies depending on local regulations; If this parameter is set to 0, the standstill annunciator is always lit and operations requiring standstill are performed regardless of scale motion; If 0 is selected, ZTBND must also be set to 0; <i>Enter value: 0–100, 1 (default)</i>

Table 4-4. Setup – Configuration Menu Descriptions

Menu	Description
oUrLoR	Overload – Determines the point at which the display blanks and the overload error message displays (^^^^^^); Maximum legal value varies depending on local regulations; <i>Settings: FS+2% (default), FS+1D, FS+9D, FS</i>
SnPrRt	Sample Rate – Selects measurement rate, in samples per second, of the analog-to-digital converter; Lower sample rate values provide greater signal noise immunity; <i>Settings: 6.25HZ, 7.5HZ, 12.5HZ, 15HZ, 25HZ, 30HZ (default), 50HZ, 60HZ, 100HZ, 120HZ</i>
FLtErChn	Filter Chain Type – Sets the filter type to be used; <i>Settings:</i> AVGONLY (default) – Digital Rolling Average Filter (Section 11.7.1 on page 65); Uses DIGFL 1-3, DFSENS and DFTHR ADPONLY – Adaptive Filter (Section 11.7.2 on page 66); Uses ADSENS and ADTHR DMPONLY – Damping Filter (Section 11.7.3 on page 67); Uses DAMPVAL RAW – No filtering
dIGFL 1-3	Digital Filters – Sets the digital filtering rate used to reduce the effects of environmental influences from the immediate area of the scale; <i>Settings indicate the number of A/D conversions per update which are averaged to obtain the displayed reading; a higher number gives a more accurate display by minimizing the effect of a few noisy readings, but slows down the response time of the indicator; Settings: 1, 2, 4 (default), 8, 16, 32, 64, 128, 256</i>
dFSEnS	Digital Filter Sensitivity – Specifies the number of consecutive A/D readings which fall outside the Filter Threshold before filtering is suspended; <i>Settings: 2OUT (default), 4OUT, 8OUT, 16OUT, 32OUT, 64OUT, 128OUT</i>
dFtHRH	Digital Filter Threshold – Sets a threshold value, in display divisions; when a number of consecutive A/D readings (Digital Filter Sensitivity) falls outside of this threshold value (when compared to the output of the filter), filtering is suspended and the A/D value is sent straight through the filter; Filtering is not suspended if the threshold is set to NONE; <i>Settings: NONE (default), 2D, 5D, 10D, 20D, 50D, 100D, 200D, 250D</i>
RdSEnS	Adaptive Filter Sensitivity – Controls the stability and response time of the scale; <i>Settings:</i> LIGHT (default) – Fastest response to small weight changes, but less stable MEDIUM – Has a quicker response time than heavy, but more stable than light HEAVY – Results in an output which is more stable but settles slowly; small changes in weight data (a few grads) on the scale base are not seen quickly
RdtHRH	Adaptive Filter Threshold – Sets the adaptive filter weight threshold value (in display divisions); a weight change exceeding the threshold resets the filtered values; must be set above the noise disturbances in the system (if set to zero, the filter is disabled); <i>Enter value: 0–2000, 10 (default)</i>
dRnPrL	Damping Value – Sets the damping time constant (in 0.1 sec intervals); <i>Enter value: 0–2560, 10 (default)</i>
rLtErRP	RattleTrap – Enables RattleTrap filtering; Effective at eliminating vibration effects, environmental influences and mechanical interference from nearby machinery, may increase response time over standard digital filtering; <i>Settings: OFF (default), ON</i>
tRrE Fn	Tare Function – Enables or disables push-button and keyed tare; <i>Settings:</i> BOTH (default) – Both push-button and keyed tare are enabled NOTARE – No tare allowed (gross mode only) PBTARE – Push-button tares enabled KEYED – Keyed tare enabled
SS t,nE	Standstill Time – Specifies the length of time the scale must be out of motion, before the scale is considered to be at standstill (in 0.1 sec intervals); <i>Enter value: 0–600, 10 (default)</i>
SEnSE	Sense – Specifies the type of load cell cable connected to the J1 connector (Section 2.4.3 on page 7); <i>Settings: 4-WIRE (default), 6-WIRE</i>

Table 4-4. Setup – Configuration Menu Descriptions (Continued)

4.4.2 Setup – Format Menu

4.4.2.1 Primary and Secondary Menus

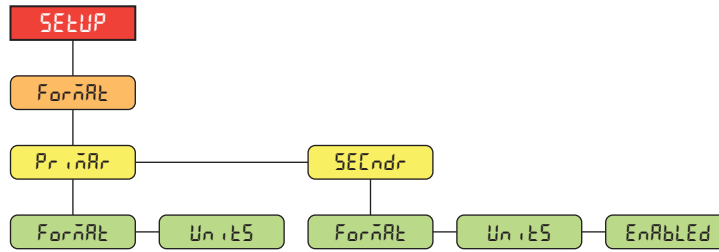

Figure 4-6. Format – Primary and Secondary Menus

Parameter	Description
Format	Format – Sets the decimal point and the display divisions for the Primary (Primary) and Secondary (Secondary) display weight format; For example, select 8888.885 if a count by of 0.005 is needed or select 8888820 if a count by of 20 is needed (the 8s serve as placeholders and show a breakdown of how digits will display); Settings: 8888881 (Primary default), 8888882, 8888885, 8888810, 8888820, 8888850, 8888100, 8888200, 8888500, 8.888881, 8.888882, 8.888885, 88.88881, 88.88882, 88.88885, 888.8881, 888.8882, 888.8885, 8888.881, 8888.882, 8888.885, 88888.81, 88888.82, 88888.85, 888888.1, 888888.2, 888888.5 (Secondary default)
Units	Units – Sets the units type; Settings: LB (Primary default), KG (Secondary default), OZ, TN, T, G, NONE
Enabled	Enabled – Enables the front panel UNITS button to toggle between the primary and secondary formats (only displays under Secondary); Settings: ON (default), OFF

Table 4-5. Format – Primary and Secondary Menu Parameters

4.4.3 Setup – Calibration Menu

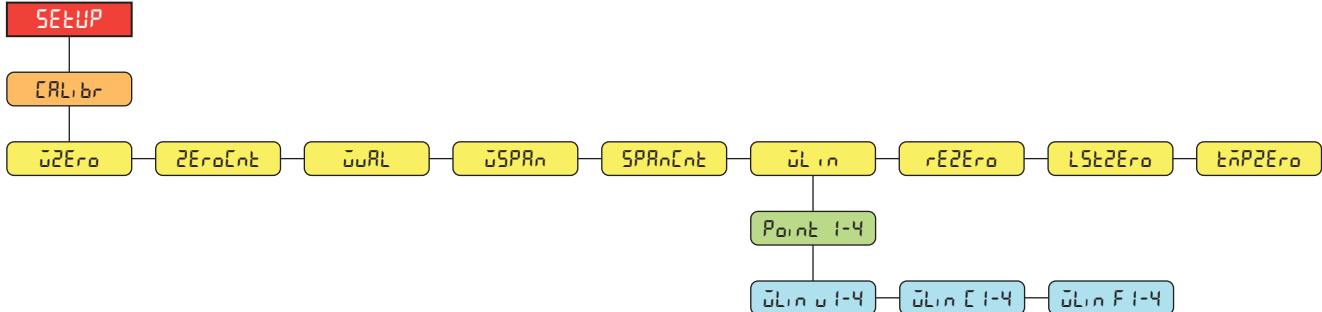

Figure 4-7. Setup – Calibration Menu

Parameter	Description
WZERO	Zero Calibration – Executes the zero calibration process; See Section 5.1 on page 40
ZEROCount	Zero Calibration Count – Displays the raw count value at the zero weight; A zero calibration (WZERO) generates this raw count value; Manually changing this count value changes the zero weight and negates the zero calibration
WWT	Test Weight Value – Sets the weight value for the span calibration; See Section 5.1 on page 40; Enter value: 0.000001–9999999.999999, 10000.0 (default)
WSPAN	Span Calibration – Executes the span calibration process; See Section 5.1.1 on page 40
SPANCount	Span Calibration Count – Displays the raw count value at the span weight; A span calibration (WSPAN) generates this raw count value; Manually changing this count value changes the span weight and negates the span calibration

Table 4-6. Setup – Calibration Menu Parameter

Parameter	Description
WLIN	Linear Calibration – A linear or multi-point calibration is performed by entering up to four additional calibration points; See Section 5.1.2 on page 41 WLIN V# – Sets the test weight value for linear calibration point WLIN C# – Executes the linear calibration process for the point; generates the raw count value (F) for the test weight value (V) WLIN F# – Displays the raw count value at the linear point weight; A linear calibration (WLIN C#) generates this raw count value; Manually changing this count value changes the linear point weight and negates the linear calibration for the point
REZERO	Rezero – Removes an offset value from the zero and span calibrations; See Section 5.2.3 on page 41
LASTZERO	Last Zero – Takes the last pushbutton zero in the system (from weigh mode) and uses it as the new zero reference point, after which a new span calibration must be performed; This calibration cannot be performed when calibrating a scale for the first time; See Section 5.2.1 on page 41
TEMPZERO	Temporary Zero – Temporarily zeros the displayed weight of a non-empty scale, after a span calibration was performed; The difference between the temporary zero and the previously calibrated zero value is used as an offset; See Section 5.2.2 on page 41

Table 4-6. Setup – Calibration Menu Parameter (Continued)

4.4.4 Setup – Communication Menu

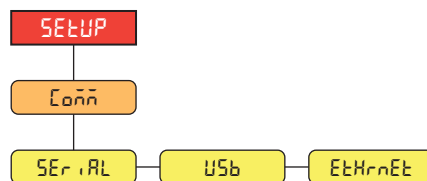

Figure 4-8. Setup – Communication Menu

Menu	Description
SERIAL	Serial Port – Supports RS-232 and RS-485/422 serial communications; See Section 4.4.4.1 on page 28
USB	USB – Intended to be connected to a PC only; appears as a Virtual COM Port and is assigned a “COMx” designation; applications communicate through the port like a standard RS-232 communications port; See Section 4.4.4.2 on page 29
ETHERNET	Ethernet – Features Ethernet TCP/IP 10Base-T/100Base-TX communication and can support two simultaneous connections, one as a server, the other as a client; See Section 4.4.4.3 on page 30

Table 4-7. Setup – Communication Menu Descriptions

4.4.4.1 Serial Port Menu

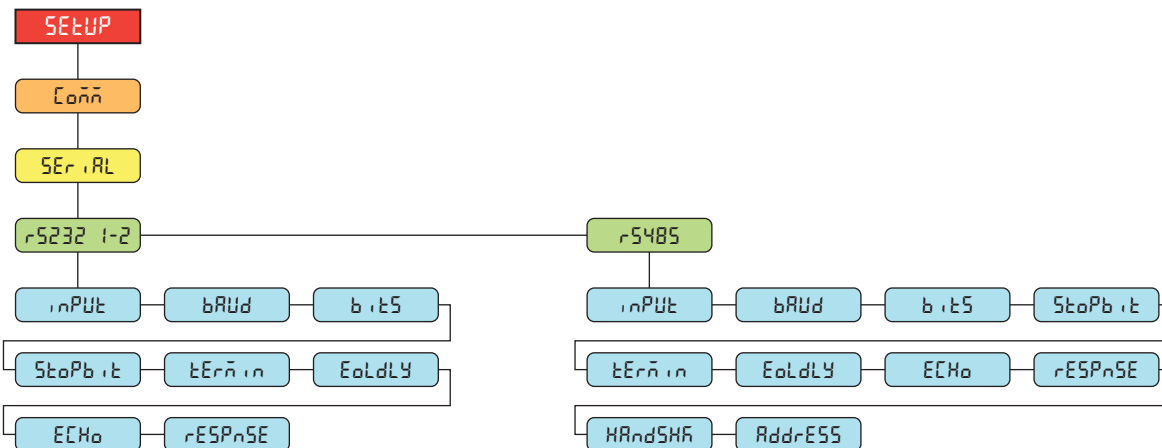

Figure 4-9. Communication – Serial Port Menu

Parameter	Description
input	Input – Sets the input trigger type; Settings: CMD (default) – Command: setting input trigger to command allows operation of EDP commands and can print STRIND – Stream Industrial Scale Data: data is updated up to the configured sample rate; allows operation of EDP commands and printing STRLFT – Stream Legal for Trade Data: data is updated at the configured display update rate; allows operation of EDP commands and printing REMOTE – Configures the port to operate as a serial scale input NOTE: When in STRIND, STRLFT and REMOTE, if the COMM port is set to RS485, the port does not stream data and cannot be used in a local/remote application
baud	Baud Rate – Sets the transmission speed for the port; Settings: 1200, 2400, 4800, 9600 (default), 19200, 28800, 38400, 57600, 115200
bits	Data Bits – Sets number of data bits transmitted or received by the port and specifies the parity bit to odd, even or none; Settings: 8NONE (default), 7EVEN, 7ODD
stopbit	Stop Bits – Sets the number of stop bits transmitted or received by the port; Settings: 1 (default), 2
termination	Outgoing Line Termination – Sets the termination character for data sent from the port; Settings: CR/LF (default), CR
enddelay	End of Line Delay – Sets the delay period from when a formatted line is terminated to the beginning of the next formatted serial output (measured in milliseconds); Enter value: 0–255, 0 (default)
echo	Echo – Specifies if characters received by the port are echoed back to the sending unit; Settings: ON (default), OFF
response	Response – Specifies if the port transmits replies to serial commands; Settings: ON (default), OFF
handshake	Port Handshaking – Specifies if XONXOFF flow control characters are used (RS-485 only); Settings: OFF (default), XONXOFF, HRDWAR
address	Address – Specifies address used to connect to the port (RS-485 only); Enter value: 0–255, 0 (default)

Table 4-8. Communication – Serial Port Menu Parameters

4.4.4.2 USB Menu

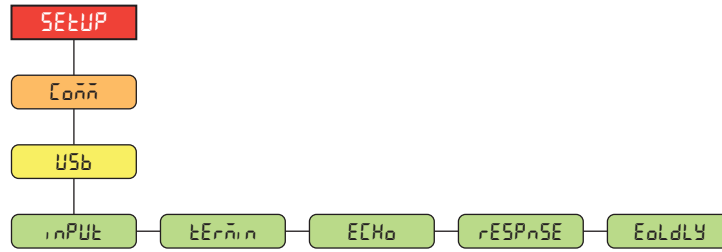

Figure 4-10. Communication – USB Menu

Parameter	Description
INPUT	Input – Sets the input trigger type; <i>Settings:</i> CMD (default) – Command: setting input trigger to command allows operation of EDP commands and can print STRIND – Stream Industrial Scale Data: data is updated up to the configured sample rate; allows operation of EDP commands and printing STRLFT – Stream Legal for Trade Data: data is updated at the configured display update rate; allows operation of EDP commands and printing REMOTE – Configures the port to operate as a serial scale input
TERMIN	Outgoing Line Termination – Sets the termination character for data sent from the port; <i>Settings:</i> CR/LF (default), CR
ECHO	Echo – Specifies if characters received by the port are echoed back to the sending unit; <i>Settings:</i> ON (default), OFF
RESPONSE	Response – Specifies if the port transmits replies to serial commands; <i>Settings:</i> ON (default), OFF
EOLLY	End of Line Delay – Sets the delay period from when a formatted line is terminated to the beginning of the next formatted serial output (measured in milliseconds); <i>Enter value: 0–255, 0</i> (default)

Table 4-9. Communication – USB Menu Parameters

4.4.4.3 Ethernet Menu

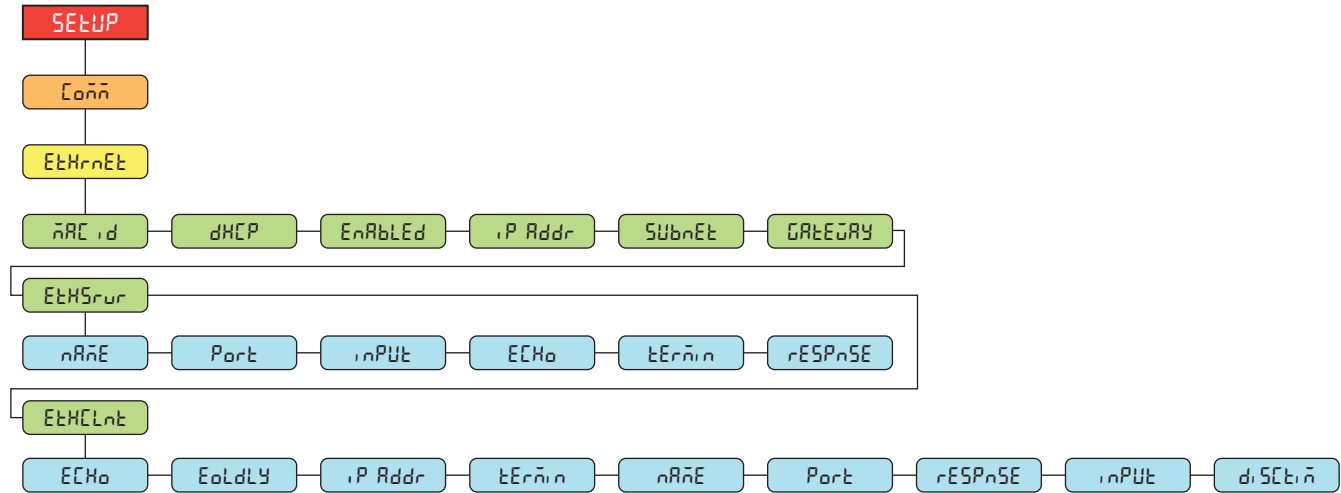

Figure 4-11. Communication – Ethernet Menu

Parameter	Description
MAC ID	Mac ID – Read only; <i>Settings: 00:00:00:00:00:00</i>
DHCP	DHCP – Dynamic Host Configuration Protocol (static allocation of IP address when OFF); <i>Settings: ON (default), OFF</i>
ENABLED	Enabled – Enables Ethernet communications; <i>Settings: OFF (default), ON</i>
IP ADDR	IP Address; <i>Enter value: 0.0.0.0</i>
SUBNET	Subnet Mask; <i>Enter value: 255.255.255.0</i>
GATEWAY	Default Gateway; <i>Enter value: 0.0.0.0</i>
ETHERSERV	Ethernet Server – Allows the 680 to receive external EDP commands; <i>Sub-parameters:</i> NAME – Name for Ethernet Server; <i>Enter characters: Alphanumeric entry up to 8 characters, TCPS (default)</i> PORT – Specifies IP Address port to open to establish communications; <i>Enter value: 1025–65535, 10001 (default)</i> INPUT – Sets the input trigger type; <i>Settings: CMD (default), NONE</i> ECHO – Specifies if characters received by the port are echoed back to the sending unit; <i>Settings: OFF (default), ON</i> TERMIN – Line Termination: Sets the termination character for data sent from the port; <i>Settings: CR/LF (default), CR</i> RESPONSE – Specifies if the port transmits replies to serial commands; <i>Settings: ON (default), OFF</i>
ETHERCLIENT	Ethernet Client – Allows the 680 to send EDP commands to external devices; <i>Sub-parameters:</i> ECHO – Specifies if characters received by the port are echoed back to the sending unit; <i>Settings: ON (default), OFF</i> EOLDLY – End of Line Delay: Sets the delay period from when a formatted line is terminated to the beginning of the next formatted serial output (measured in milliseconds); <i>Enter value: 0–255, 0 (default)</i> IP ADDR – IP Address; <i>Enter value: 0.0.0.0</i> TERMIN – Line Termination: Sets the termination character for data sent from the port; <i>Settings: CR/LF (default), CR</i> NAME – Name for Ethernet Client; <i>Enter characters: Alphanumeric entry up to 8 characters, TCPC1 (default)</i> PORT – Specifies IP Address port to look for to establish communications; <i>Enter value: 1025–65535, 10001 (default)</i> RESPONSE – Specifies if the port transmits replies to serial commands; <i>Settings: ON (default), OFF</i> INPUT – Sets the input trigger type; <i>Settings: CMD (default), STRIND, STRLFT, REMOTE</i> DISCTIM – Disconnect Timeout (in seconds); <i>Enter value: 0–60, 0 (default)</i>

Table 4-10. Communication – Ethernet Menu Parameters

4.4.5 Setup – Program Menu

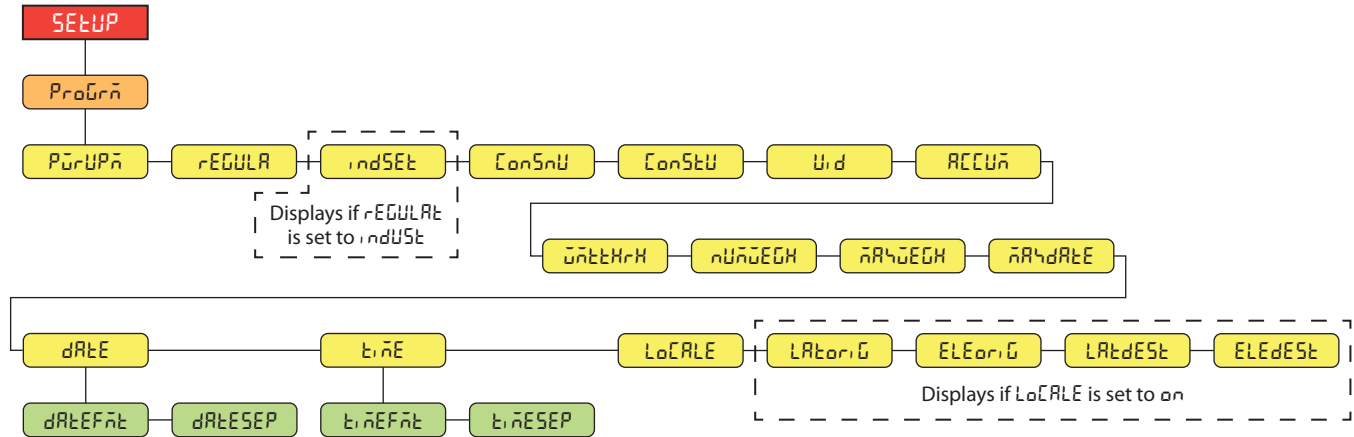

Figure 4-12. Setup – Program Menu

Parameter	Description
PowerUp	Power Up Mode – When the indicator is turned on, it performs a display test, then enters a warm up period; <i>Settings:</i> GO (default) – Performs display test, then enters weigh mode after brief warm up period DELAY – Performs display test, then enters a warm up period of 30 seconds <ul style="list-style-type: none"> • If no motion is detected during warm up period, indicator enters weigh mode when warm up period ends • If motion is detected, the 30 second timer is reset and the warm up period is repeated
REGULA	Regulatory Mode – Specifies the regulatory agency having jurisdiction over the scale site; the value specified for this parameter affects the function of the front panel tare and zero keys; <i>Settings:</i> NTEP (default) , OIML, CANADA, INDUST, NONE <ul style="list-style-type: none"> • OIML, NTEP, and CANADA modes allow a tare to be acquired at a weight greater than zero; NONE allows tares to be acquired at any weight value • OIML, NTEP, and CANADA modes allow a tare to be cleared only if the gross weight is at no load; NONE allows tares to be cleared at any weight value • NTEP and OIML modes allow a new tare to be acquired even if a tare is already present; In CANADA mode, the previous tare must be cleared before a new tare can be acquired • NONE, NTEP and CANADA modes allow the scale to be zeroed in either gross or net mode as long as the current weight is within the specified ZRANGE; In OIML mode, the scale must be in gross mode before it can be zeroed; pressing the ZERO key in net mode clears the tare • INDUST provides a set of sub-parameters to allow customization of tare, clear, and print functions in non Legal-for-Trade scale installations
INDUST	Industrial Settings – Displays when REGULA parameter is set to INDUST; See Section 4.4.5.1 on page 32
CONSNU	Consecutive Numbering – Allows sequential numbering for print operations; the value is incremented following each print operation which includes <CN> in the ticket format; <i>Enter value:</i> 0–9999999, 0 (default)
CONSNU	Consecutive Number Startup Value – Specifies the initial consecutive number (CONSNU) value used when the consecutive number is reset by sending CLRCN digital input; <i>Enter value:</i> 0–9999999, 0 (default)
Unit	Unit ID – Specifies the unit identification number with an alphanumeric value; <i>Enter characters:</i> Up to 6 alphanumeric characters, 1 (default)
ACCUM	Accumulator – Accumulation can be toggled ON/OFF; if ON, accumulation occurs on print operation; if OFF, an accumulation does not occur; <i>Settings:</i> OFF (default) , ON
WEIGHT THRESHOLD	Weight Threshold – When the weight falls below the value set, the accumulator is rearmed; <i>Enter value:</i> 0.0–9999999.0, 1000.0 (default)
NUMBER OF WEIGHMENTS	Number of Weighments – Displays the total number of weighments; <i>Read only</i>
MAXIMUM WEIGHMENT	Maximum Weighment – Displays the maximum weighment allowed; <i>Read only</i>
DATE/TIME OF MAX WEIGHT	Date/Time of Max Weight – Displays the date the maximum weighment occurred; <i>Read only</i>
DATE	Date – Allows setting of the date format and date separator character DATEFMT – Date Format; <i>Settings:</i> MMDDYY (default) , DDMMYY, YYMMDD, YYDDMM DATESEP – Date Separator; <i>Settings:</i> SLASH (default) , DASH, SEMI, DOT

Table 4-11. Setup – Program Menu Parameters

Parameter	Description
ፎርማት	Time – Allows setting of the time format and the separator character TIMEFMT – Time Format; Settings: 12HOUR (default), 24HOUR TIMESEP – Time Separator; Settings: COLON (default), COMMA, DOT
ሎኒሎ	Location Gravity Compensation – Enables gravity compensation; Settings: OFF (default), ON
ላቲቲዩድ	Latitude of Origin – Original latitude (to nearest degree) for gravity compensation; Enter value: 0–90, 45 (default)
ኢሌቫሽን	Elevation of Origin – Original elevation (in meters) for gravity compensation; Enter value: -9999–9999, 345 (default)
ላቲቲዩድ	Latitude of Destination – Destination latitude (to nearest degree) for gravity compensation; Enter value: 0–90, 45 (default)
ኢሌቫሽን	Elevation of Destination – Destination elevation (in meters) for gravity compensation; Enter value: -9999–9999, 345 (default)

Table 4-11. Setup – Program Menu Parameters (Continued)

4.4.5.1 Industrial Settings Menu

The industrial settings menu (ገንባታ) only displays if the regulation parameter (ገንባታ) is set to industrial (ገንባታ).

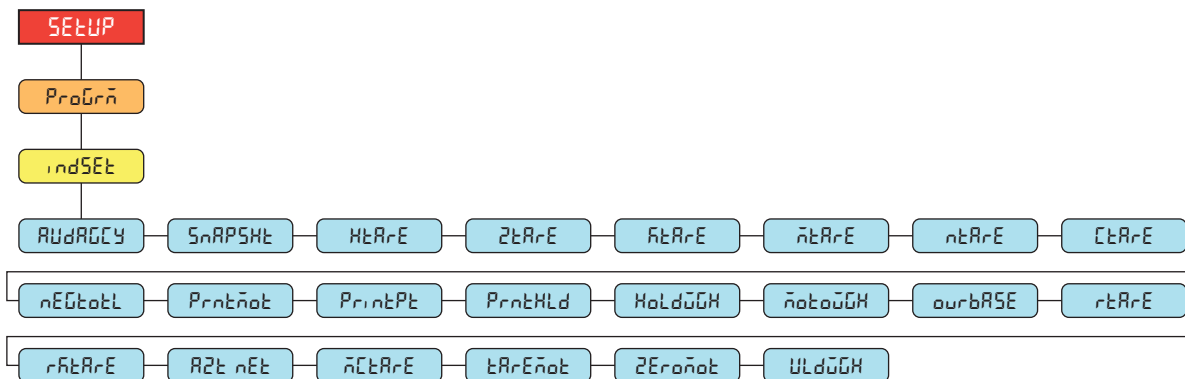

Figure 4-13. Industrial Settings Menu

Parameter	Description
የላቲቲዩድ	Audit Agency – Audit trail display agency format; Settings: NTEP (default), CANADA, NONE, OIML
ገንባታ	Snap Shot – Display or scale weight source; Settings: DISPLAY (default), SCALE
ዘይታ	Hold Tare – Allow tare in display hold; Settings: NO (default), YES
ደድታ	Zero Tare – Remove tare on zero; Settings: NO (default), YES
ቆይታ	Keyed Tare – Always allow keyed tare; Settings: YES (default), NO
ቆይታ	Multiple Tare – Replaces existing tare when the tare key is pressed; Settings: REPLACE (default), REMOVE, NOTHING
ቆይታ	Negative/Zero Tare – Allow negative or zero tare; Settings: NO (default), YES
ፍጥነት	Clear Tare/Accumulator – Allow clear key to clear tare/accumulator; Settings: YES (default), NO
ቆይታ	Negative Total – Allow total scale to display negative value; Settings: NO (default), YES
ገንባታ	Print In Motion – Allow print while in motion; Settings: NO (default), YES
ገንባታ	Print Preset Tare – Add preset tare (PT) to keyed tare print; Settings: YES (default), NO
ገንባታ	Print Hold – Print during display hold; Settings: NO (default), YES
ዘይታ	Hold Weighment – Allow weighment during display hold; Settings: NO (default), YES
ቆይታ	Motion Weighment – Allow weighment in motion; Settings: NO (default), YES
ቆይታ	Overload Base – Zero base for overload calculation; Settings: CALIB (default), SCALE
ቆይታ	Round Button Tare – Round pushbutton tare to the nearest display division; Settings: NO (default), YES
ቆይታ	Round Keyed Tare – Round keyed tare to the nearest display division; Settings: NO (default), YES
ቆይታ	AZT On Net Value – Perform auto zero tracking on net value; Settings: NO (default), YES
ቆይታ	Manual Clear Tare – Allow manual clearing of the tare value; Settings: YES (default), NO
ቆይታ	Tare In Motion – Allow tare in motion; Settings: NO (default), YES
ቆይታ	Zero In Motion – Allow scale to be zeroed while in motion; Settings: NO (default), YES
ቆይታ	Underload Weight – Underload weight value in display divisions; Enter value: 1–9999999, 20 (default)

Table 4-12. Industrial Settings Menu Parameters

4.4.6 Setup – Print Format Menu

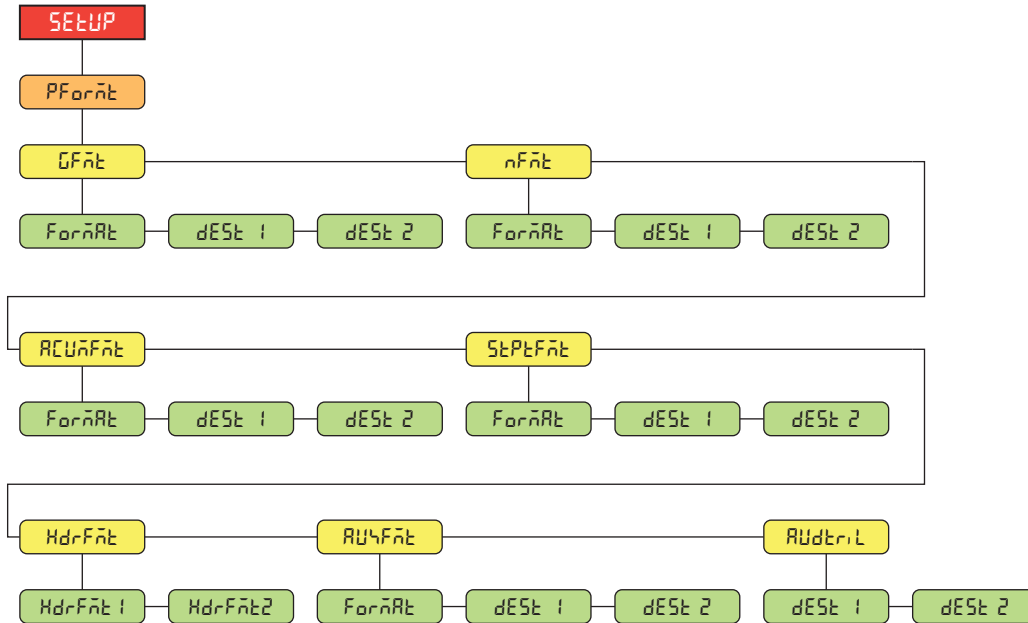

Figure 4-14. Setup – Print Format Menu

Parameter	Description
GFñt	Gross Format – Gross demand print format string FORMAT – Enter characters: Alphanumeric entry up to 1000 characters, Gross<g><n/2><td><n/2> (default) DEST 1-2 – Destination ports; Settings: RS232-1 (default), RS232-2, RS485, TCPC, USB, NONE (DEST 2 default)
nFñt	Net Format – Net demand print format string FORMAT – Enter characters: Alphanumeric entry up to 1000 characters, Gross<g><n/2>Tare<sp><td><n/2>Net<sp><n/2><td><n/2> (default) DEST 1-2 – Destination ports; Settings: RS232-1 (default), RS232-2, RS485, TCPC, USB, NONE (DEST 2 default)
RCUñFñt	Accumulator Format – Accumulator print format string FORMAT – Enter characters: Alphanumeric entry up to 1000 characters, Accum <a><n/2><da> <ti><n/2> (default) DEST 1-2 – Destination ports; Settings: RS232-1 (default), RS232-2, RS485, TCPC, USB, NONE (DEST 2 default)
StPtFñt	Setpoint Format – Setpoint print format string FORMAT – Enter characters: Alphanumeric entry up to 1000 characters, <scv><sp><spm><n/2> (default) DEST 1-2 – Destination ports; Settings: RS232-1 (default), RS232-2, RS485, TCPC, USB, NONE (DEST 2 default)
HdrFñt	Header Format – Ticket header format strings HDRFMT1 – Header 1 Format String; Enter characters: Alphanumeric entry up to 1000 characters, Company Name<n/2>Street Address<n/2>City St Zip<n/2> (default) HDRFMT2 – Header 2 Format String; Enter characters: Alphanumeric entry up to 1000 characters, Company Name<n/2>Street Address<n/2>City St Zip<n/2> (default)
RUYñFñt	Auxiliary Format (not implemented) – Auxiliary ticket format string FORMAT – Enter characters: Alphanumeric entry up to 1000 characters, Gross<g><n/2><td><n/2> (default) DEST 1-2 – Destination ports; Settings: RS232-1 (default), RS232-2, RS485, TCPC, USB, NONE (DEST 2 default)
RUDtRiL	Audit Trail – Audit trail port DEST 1-2 – Destination ports; Settings: RS232-1 (default), RS232-2, RS485, TCPC, USB, NONE (DEST 2 default)

Table 4-13. Setup – Print Format Menu Parameters

4.4.7 Setup – Stream Format Menu

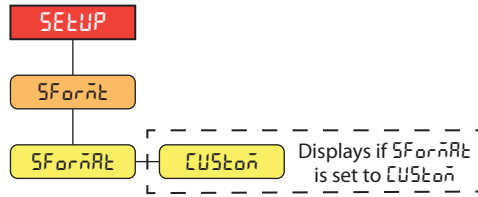

Figure 4-15. Setup – Stream Format Menu

Parameter	Description
SFORMAT	Stream Format – Specifies the stream format used for streaming output of scale data or specifies the expected input for a serial scale; <i>Settings:</i> RLWS (default) – Rice Lake Weighing Systems stream format (Section 11.3.1 on page 63) CARDNAL – Cardinal stream format (Section 11.3.2 on page 63) WTRONIX – Avery Weigh-Tronix stream format (Section 11.3.3 on page 64) TOLEDO – Mettler Toledo stream format (Section 11.3.4 on page 64) CUSTOM – Custom stream format
CUSTOM	Custom Stream Format – Specifies the custom stream format; only displays if SFORMAT is set to CUSTOM; <i>Enter characters: Alphanumeric entry up to 1000 characters</i>

Table 4-14. Setup – Stream Format Menu Parameters

4.4.8 Setup – Setpoints Menu

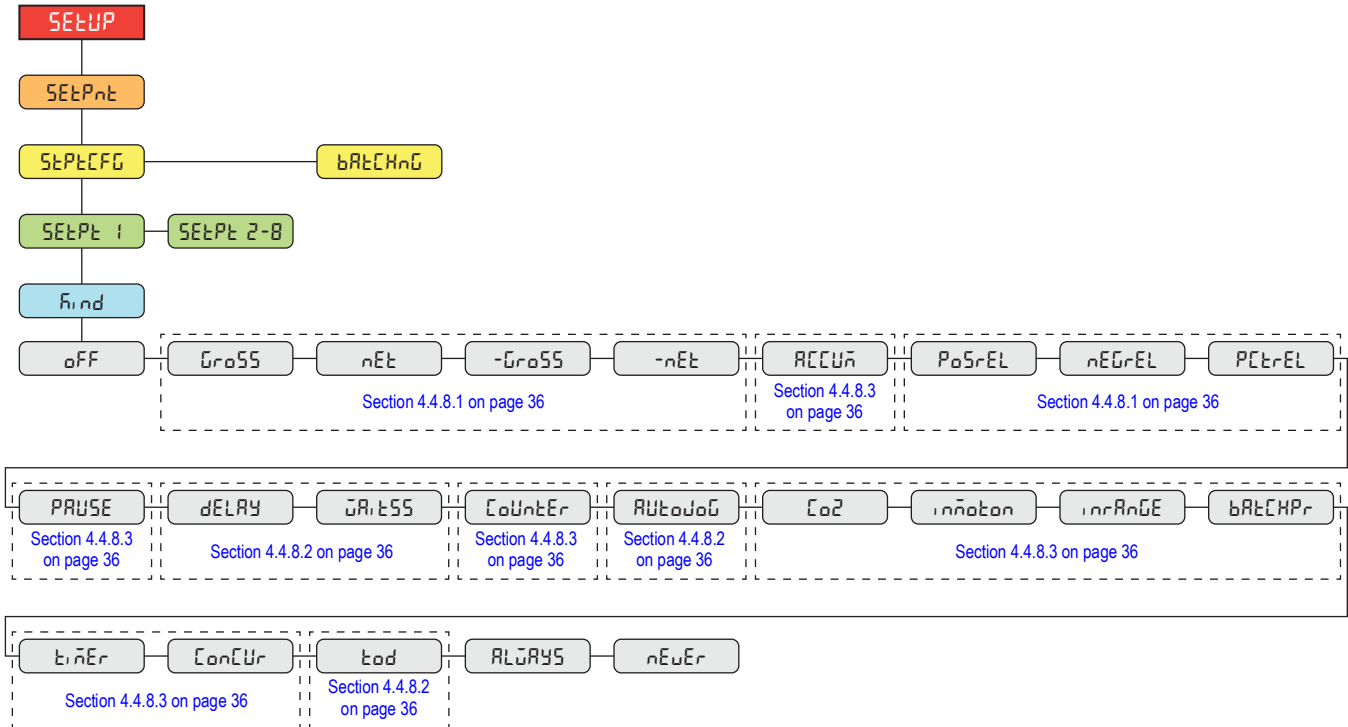

Figure 4-16. Setup – Setpoints Menu

Parameter	Description
SETPtCFG	Setpoint Configuration – Access to configuration parameters and settings for up to eight setpoints; Settings: SETPT 1-8 Find – Setpoint Kind: Settings: OFF (default), GROSS, NET, -GROSS, -NET, ACCUM, POSREL, NEGREL, PCTREL, PAUSE, DELAY, WAITSS, COUNTER, AUTOJOG, COZ, INMOTON, INRANGE, BATCHPR, TIMER, CONCUR, TOD, ALWAYS, NEVER
bATCHnG	Batching – Batch sequence runs when set to AUTO or MANUAL; Settings: OFF (default) AUTO – Allows the batch sequence to repeat automatically once it has been started MANUAL – Requires a BATSTRT input/command to run the batch sequence

Table 4-15. Setup – Setpoints Menu Parameters

4.4.8.1 If KIND = GROSS, NET, -GROSS, -NET, POSREL, NEGREL, PCTREL

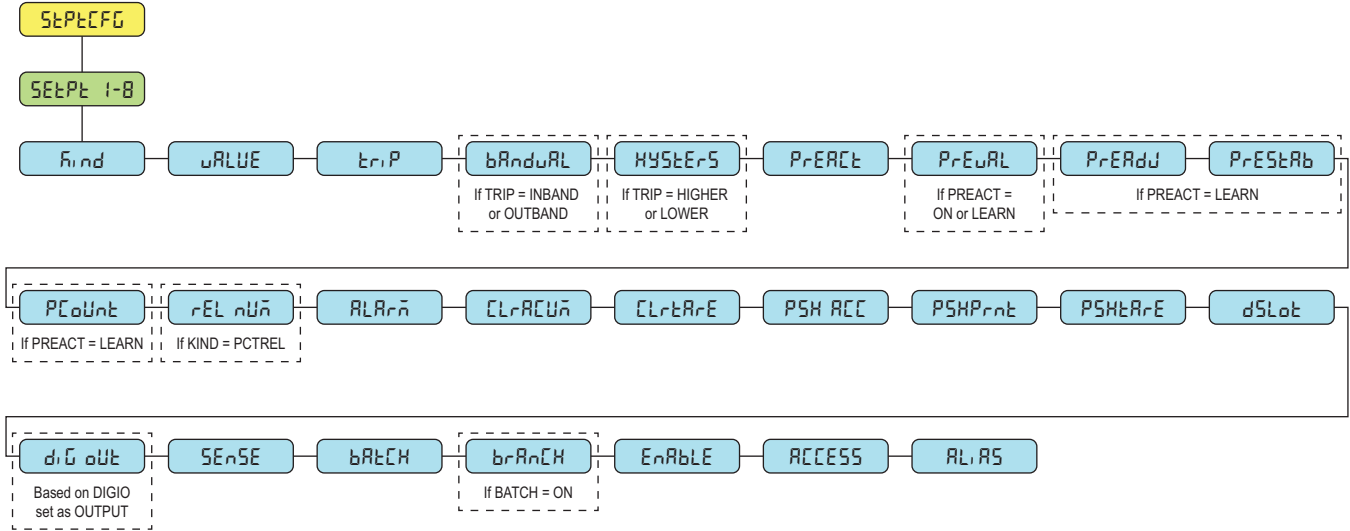

Figure 4-17. Setpoints – Parameter Group A

4.4.8.2 If KIND = ACCUM, DELAY, WAITSS, AUTOJOG, TOD

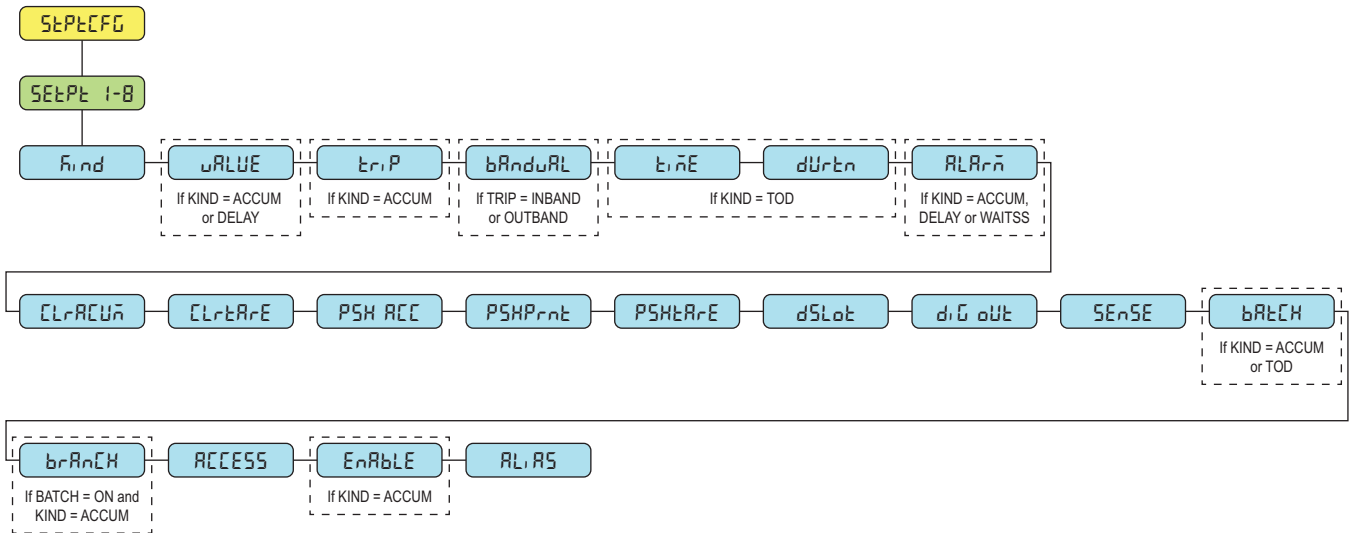

Figure 4-18. Setpoints – Parameter Group B

4.4.8.3 If KIND = PAUSE, COUNTER, COZ, INMOTON, INRANGE, BATCHPR, TIMER, CONCUR

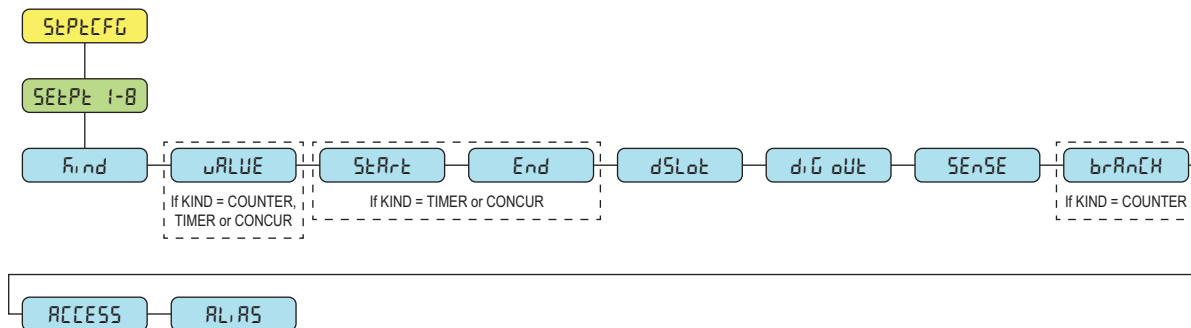

Figure 4-19. Setpoints – Parameter Group C

Parameter	Description
VALUE	Setpoint Value – For weight-based setpoints: <i>Enter value: 0.0–9999999.0, 0.0 (default)</i> For time-based setpoints: <i>Enter value: 0.0–65535.0, 0.0 (default)</i> For COUNTER setpoints: <i>Enter value: 0.0–65535.0, 0.0 (default)</i>
TRIP	Trip – Specifies whether the setpoint is satisfied when the weight is higher or lower than the setpoint value, within a band established around the value, or outside of the band; in a batch sequence with TRIP=HIGHER, the associated digital output is active until the setpoint value is reached or exceeded; with TRIP=LOWER, the output is active until the weight goes below the setpoint value; <i>Settings: HIGHER (default), LOWER, INBAND, OUTBAND</i>
BNDVAL	Band Value – For setpoints with TRIP=INBAND or OUTBAND, specifies a weight equal to half the band width; The band established around the setpoint value is VALUE ±BNDVAL; <i>Enter value: 0.0–9999999.0, 0.0 (default)</i>
HYSTER	Hysteresis – Specifies a band around the setpoint value which must be exceeded before the setpoint, once off, can trip on again; <i>Enter value: 0.0–9999999.0, 0.0 (default)</i>
PRACT	Preact Type – Allows the digital output associated with a setpoint to shut off before the setpoint is satisfied to allow for material in suspension; <i>Settings: OFF (default)</i> <i>ON – Adjusts setpoint trip value up or down (depending on the TRIP parameter setting) from setpoint value using a fixed value specified on the PREVAL parameter</i> <i>LEARN – Can be used to automatically adjust the PRACT value after each batch; it compares the actual weight at standstill to the target setpoint value and adjusts the PREVAL by the PREADJ value times the difference after each batch</i> <i>FLOW – Not implemented</i>
START	Starting Setpoint – Specifies starting setpoint number; do not specify number of the TIMER or CONCUR setpoint itself; TIMER or CONCUR setpoint begins when starting setpoint begins; <i>Enter value: 1–8, 1 (default)</i>
END	Ending Setpoint – Specifies ending setpoint number; do not specify number of the TIMER or CONCUR setpoint itself; TIMER or CONCUR setpoint stops when ending setpoint begins; <i>Enter value: 1–8, 1 (default)</i>
TIME	Time – For TOD setpoints, specifies the time at which the setpoint becomes active; the format used to enter the time (12hour or 24hour) is based on the value specified for the TIMEFMT parameter in the Program menu (HHMM); <i>Enter value: 0000 (default)</i>
DUR	Duration – For TOD setpoints; specifies the length of time the digital output associated with this setpoint changes state; value is entered in hours, minutes, and seconds (HHMMSS); <i>Enter value: 000000 (default)</i>
PVAL	Preact Value – Specifies the preact value for setpoints with PRACT set to ON or LEARN; depending on the TRIP setting specified for the setpoint, the setpoint trip value is adjusted up or down by the PREVAL value; <i>Enter value: 0.0–9999999.0, 0.0 (default)</i>
PADJ	Preact Adjustment – Setpoints with PRACT set to LEARN, specifies a decimal representation of the percentage of error correction applied (0.5 = 0.5%, 50.0 = 50%, 100.0 = 100%) each time a PRACT adjustment is made; <i>Enter value: 0.0–100.0, 0.5 (default)</i>
PSTO	Preact Stabilization Time-Out – Setpoints with PRACT set to LEARN, specifies the time, in 0.1-sec intervals, to wait for standstill before adjusting the PRACT value; setting this parameter to a value greater than zero disables the learn process if standstill is not achieved in the specified interval (in tenths of a second); <i>Enter value: 0–65535, 0 (default)</i>
PIC	Preact Learn Interval Count – Setpoints with PRACT set to LEARN, specifies the number of batches after which the preact value is recalculated; the default value, 1, recalculates the preact value after every batch cycle; <i>Enter value: 1–65535, 1 (default)</i>
REL	Relative Number – For relative setpoints, specifies the number of the relative setpoint; <i>Enter value: 1–8, 1 (default)</i> Target weight for this setpoint is determined as follows: POSREL setpoints, the value of the relative setpoint plus the value (VALUE parameter) of the POSREL setpoint NEGREL setpoints, the value of the relative setpoint minus the value of the NEGREL setpoint PCTREL setpoints, the percentage (specified on VALUE parameter of the PCTREL setpoint) of the target value of the relative setpoint
ALARM	Alarm – Specify ON to display the word ALARM on the primary display while the setpoint is active (batch setpoints) or while the setpoint is not tripped (continuous setpoints); <i>Settings: OFF (default), ON</i>
CLACC	Clear Accumulator – Specify ON to clear the accumulator when the setpoint is satisfied; <i>Settings: OFF (default), ON</i>
CLTARE	Clear Tare – Specify ON to clear the tare when the setpoint is satisfied; <i>Settings: OFF (default), ON</i>
PUSHACC	Push Accumulator – Specify ON to update the accumulator and perform a print operation when the setpoint is satisfied; specify ONQUIET to update the accumulator without printing; <i>Settings: OFF (default), ON, ONQUIET</i>
PUSHPRINT	Push Print – Specify ON to perform a print operation when the setpoint is satisfied; specify WAITSS to wait for standstill after setpoint is satisfied before printing; <i>Settings: OFF (default), ON, WAITSS</i>
PUSHTARE	Push Tare – Specify ON to perform an acquire tare operation when the setpoint is satisfied; <i>Settings: OFF (default), ON</i> NOTE: PSHTARE acquires the tare regardless of the value specified for the REGULA parameter in the Program menu
DIGOUT	Digital Output Slot – Lists all available digital I/O slots; this parameter specifies the slot number of the digital I/O card referenced by the DIG OUT parameter; <i>Settings: NONE (default), 0</i>

Table 4-16. Kind Parameter Descriptions

Parameter	Description
DIOUT	Digital Output – Lists all digital output bit numbers available for the specified digital output slot; this parameter is used to specify the digital output bit associated with this setpoint; use the DIGIO menu to assign bit function to OUTPUT; <i>Enter value: 1–4, 1 (default)</i> NOTE: For continuous setpoints, the digital output becomes active (low) when the condition is met; for batch setpoints, the digital output is active until the setpoint condition is met
SENSE	Sense – Specifies whether the value of the digital output associated with this setpoint is inverted when the setpoint is satisfied; <i>Settings: NORMAL (default), INVERT</i>
BATCH	Batch – Specifies whether the setpoint is used as a batch (ON) or continuous (OFF) setpoint; <i>Settings: OFF (default), ON</i>
BRANCH	Branch Destination – Specifies the setpoint number to which the batch sequence is to branch, if the current setpoint is not satisfied upon initial evaluation (0 = do not branch); <i>Enter value: 0–8, 0 (default)</i>
ENABLE	Enable – Specifies if setpoint parameters display in user mode; <i>Settings: ON (default), OFF</i>
ACCESS	Access – Specifies the access allowed to setpoint parameters in user mode; <i>Settings: ON (default) – Values can be displayed and changed HIDE – Values cannot be displayed or changed OFF – Values can be displayed but not changed</i>
ALIAS	Alias – Name for the setpoint; <i>Enter characters: Alphanumeric entry up to 8 characters, SETPT (default)</i>

Table 4-16. Kind Parameter Descriptions (Continued)

4.4.9 Setup – Digital I/O Menu

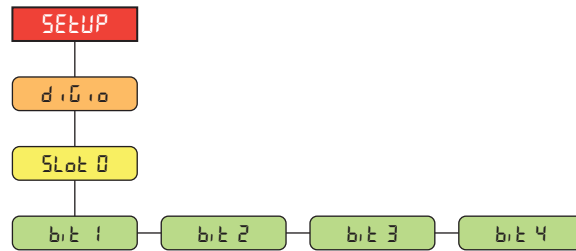

Figure 4-20. Setup – Digital I/O Menu

Parameter	Description
bit 1-4	Digital I/O Bit 1-4 – Specifies the mode and function of the digital I/O pins; <i>Settings: OFF (default), PRINT, ZERO, TARE, UNITS, PRIM, SEC, CLEAR, DSPACC, DSPTAR, CLRACC, CLRTAR, NT/GRS, GROSS, NET, CLRCN, KBDLOC, BATRUN, BATSTRT, BATPAUS, BATRESE, BATSTOP, OUTPUT</i>

Table 4-17. Setup – Digital I/O Menu Parameters

4.4.10 Setup – Analog Output Menu

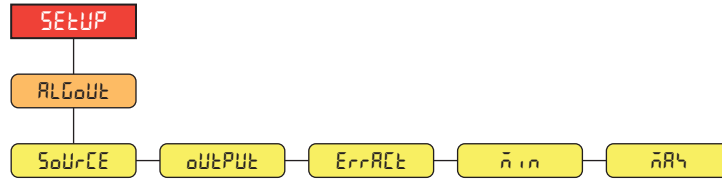

Figure 4-21. Setup – Analog Output Menu

Parameter	Description
SOURCE	Source – Specifies the scale tracked by the analog output; Settings: GROSS (default), NET
OUTPUT	Output – Specifies the voltage or current tracked by the analog output; Settings: 0-10V (default), 0-20MA, 4-20MA
ERROR	Error Action – Specifies how the analog output responds to system error conditions; Settings: FULLSC (default) – Set to full scale (10 V or 20 mA) HOLD – Holds current value ZEROSC – Sets to zero value (0 V, 0 mA or 4 mA)
MIN	Minimum Weight – Specifies the minimum weight value tracked by the analog output; Enter value: ±9999999.0, 0.0 (default)
MAX	Maximum Weight – Specifies the maximum weight value tracked by the analog output; Enter value: ±9999999.0, 10000.0 (default)

Table 4-18. Setup – Analog Output Menu Parameters

4.5 Accumulator Menu



Figure 4-22. Accumulator Menu

Parameter	Description
DISP	Display Accumulator – Displays the accumulator value; Read Only
PRINT	Print Accumulator – Prints the accumulator value to specified port, if setup
CLEAR	Clear Accumulator – Clears the accumulator value

Table 4-19. Accumulator Menu Parameters

4.6 Tare Menu

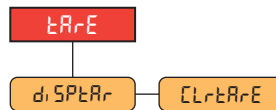

Figure 4-23. Tare Menu

Parameter	Description
DISP	Display Tare – Displays the current tare value; Read Only
CLEAR	Clear Tare – Clears the current tare value

Table 4-20. Tare Menu Parameters

5.0 Calibration

The 680 can be calibrated using the front panel and EDP commands. The following sections describe the procedures required for these calibration methods.



Note The 680 requires a WZERO and WSPAN points to be calibrated. The linear calibration points are optional; they must fall between zero and span, but must not duplicate zero or span.

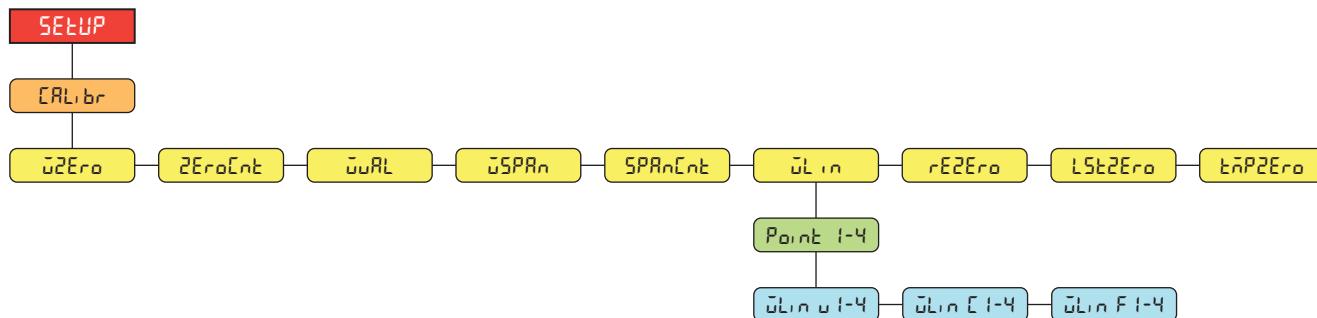

Figure 5-1. Calibration Menu

5.1 Front Panel Calibration

5.1.1 Span Calibration

Use the following steps to perform a standard span calibration on a connected scale.

1. Access the setup menu by pressing the setup switch (Section 4.1 on page 22). CONF displays.
2. Press twice. CALibr displays.
3. Press . uZERO displays.



Note See Section 5.2 on page 41 if the application requires a rezero, last zero or temporary zero.

4. Ensure there is no weight on the scale.
5. Press to perform a zero calibration. oF displays.
6. Press . ZEROEnt displays. See Section 4.4.3 on page 26 for more information on ZEROEnt .
7. Press . uARL displays.
8. Press . The current test weight value displays.
9. Press and use the numeric keypad to enter a new value, if necessary.
10. Press to accept value. uSPRn displays.
11. Place the specified amount of test weight on the scale.
12. Press to perform a span calibration. oF displays.
13. Press . SPRnEnt displays. See Section 4.4.3 on page 26 for more information on SPRnEnt .













Note Span calibration is complete. To continue with a linear calibration, see Section 5.1.2 on page 41 before returning to weigh mode.

14. Press to return to weigh mode.

5.1.2 Linear Calibration

Linear calibration points provide increased scale accuracy by calibrating the indicator at up to four additional points between the zero and span calibrations.

1. Complete [steps 1–13](#) in [Section 5.1.1 on page 40](#). Press . \bar{L}_1 displays.
2. Press . P_0 displays.
3. Press . \bar{L}_1 displays.
4. Press . The current test weight value for point 1 displays.
5. Press  and use the numeric keypad to enter a new value, if necessary.
6. Press  to accept value. \bar{L}_1 displays.
7. Place the specified amount of test weight on the scale.
8. Press  to perform a linear point calibration. \bar{L}_1 displays.
9. Press . \bar{L}_1 displays. See [Section 4.4.3 on page 26](#) for more information on \bar{L}_1 F#.
10. Press . P_0 displays.
11. Press . P_2 displays.
12. Repeat previous steps for points 2-4, if necessary.



Note *The linear calibration for a point is saved once point is calibrated.*

13. Press  to return to weigh mode.

5.2 Alternative Zero Calibrations

During a calibration, the zero value (\bar{L}_1) can be replaced with a temporary zero (\bar{L}_1) or last zero (\bar{L}_1). A rezero (\bar{L}_1) can be done after calibration. See below for information on these alternative zeros.

5.2.1 Last Zero

This takes the last push-button zero in the system (from weigh mode) and uses it as the new zero reference point, after which a new span calibration must be performed. This calibration cannot be performed when calibrating a scale for the first time.

A last zero calibration is typically used on truck scales to allow a scale verification to become a calibration without having to remove the test weights.

5.2.2 Temporary Zero

A temporary zero calibration temporarily zeros the displayed weight of a non-empty scale. After span calibration, the difference between the temporary zero and the previously calibrated zero value is used as an offset.

A temporary zero calibration is typically used on hopper scales to calibrate the span without losing the original zero calibration.

5.2.3 Rezero

A rezero calibration is needed to remove a calibration offset when hooks or chains are required to suspend the test weights.

Once a span calibration is complete, remove the hooks or chains and the test weights from the scale. With all the weight removed, a rezero calibration is used to adjust the zero and span calibration values.

5.3 EDP Command Calibration

Use the following instructions to calibrate the 680 using EDP commands. For information on the EDP commands of the 680, see [Section 7.0 on page 44](#).



Note *The indicator must respond with OK after each step or the calibration procedure must be done again.*

1. Press the setup switch to place indicator in setup mode ([Section 4.1 on page 22](#)).
2. For a standard calibration, remove all weight from scale (except hooks or chains which are needed to attach weights).
3. Send the command **SC.WZERO#s** to perform a standard calibration of the zero point.
 - Send **SC.TEMPZERO#s** to perform a temporary zero calibration
 - Send **SC.LASTZERO#s** to perform a last zero calibration
4. Apply the span calibration weight to the scale.
5. Send the command **SC.WVAL#s=xxxxx**, where **xxxxx** is the exact value of the span calibration weight applied to the scale.
6. Send the command **SC.WSPAN#s** to calibrate the span point. Continue on to [step 7](#) to calibrate additional linearization points, or proceed to [step 11](#).
7. Apply weight equal to the first linearization point to the scale.
8. Send the command **SC.WLIN#n#s=xxxxx**, where **n** is the linearization point number (1-4) and **xxxxx** is the exact value of the weight applied.
9. Send the command **SC.WLIN.Cn#s** to calibrate the linearization point.
10. Repeat [steps 7–9](#) for up to four total linearization points.
11. If hooks or chains were used to attach the weights, remove all weight, including the hooks and chains, and send the command **SC.REZERO#s** to remove the zero offset.
12. Send the command **KSAVEEXIT** to return to weigh mode.

6.0 Revolution®

The Revolution utility provides a suite of functions used to support configuration, calibration, customization and backup of the 680 software.

Calibration values and scale configuration can both be saved and restored to the 680 using Revolution.



Note For system requirements visit the Revolution product page on [Rice Lake Weighing Systems website](#).

6.1 Connecting to the Indicator

Connect the PC serial port to com 1 of the 680, then click **Connect** in the toolbar. Revolution attempts to establish communications to the indicator. If communications settings need to be adjusted, select **Options...** from the Tools menu.

Downloading to the Indicator

The **Download Configuration** function on the Revolution Communications menu allows a Revolution configuration file (with or without scale calibration data) or ticket formats to be downloaded to a connected indicator in setup mode.

The **Download Section** function on the Communications menu allows the download of only the currently displayed object, such as a scale configuration.

Because less data is transferred using the **Download Section**, it is typically faster than a full configuration download, but there is an increased possibility the download fails due to dependencies on other objects. If the download fails, try performing a complete download using the **Download Configuration** function.

Uploading Configuration to Revolution

The **Upload Configuration** function on the Revolution Communications menu allows the existing configuration of a connected indicator to be saved to a file on the PC. Once saved, the configuration file provides a backup which can be quickly restored to the indicator if needed. Alternatively, the file can be edited within Revolution and downloaded back to the indicator.

6.2 Saving and Transferring Data



Note Revolution has a module to save and transfer data. It is the preferred method over using ProComm or Hyper Terminal.

6.2.1 Saving Indicator Data to a Personal Computer

Configuration data can be saved to a computer connected to the selected port. The PC must be running a communications program such as PROCOMMPLUS®.

When configuring the indicator, ensure the values set for the baud and bits parameters on the serial menu match the baud rate, bits and parity settings configured for the serial port on the PC.

To save all configuration data, first put the communications program into data capture mode, then place the indicator in setup mode and send the DUMPALL command to the indicator. The 680 responds by sending all configuration parameters to the PC as ASCII-formatted text.

6.2.2 Downloading Configuration Data from PC to Indicator

Configuration data saved on a PC or disc can be downloaded from the PC to an indicator. This procedure is useful when a number of indicators with similar configurations are set up or when an indicator is replaced.

To download configuration data, connect the PC to the selected port as described in [Section 6.2.1](#). Place the indicator in setup mode and use the PC communications software to send the saved configuration data to the indicator. When transfer is complete, calibrate the indicator as described in [Section 5.0 on page 40](#).

6.3 Updating Firmware

Revolution is used to update the firmware of the 680 indicator. The link to begin this process is available on the Revolution home screen. Updating the firmware defaults configuration settings.

7.0 EDP Commands

The 680 indicator can be controlled by a personal computer connected to one of the indicator communication ports. Control is provided by a set of commands which can simulate front panel key press functions, return and change setup parameters, and perform reporting functions. The commands provide the capability to print configuration data or to save data to an attached personal computer. This section describes the EDP command set and procedures for saving and transferring data using the communication ports. The EDP command set is divided into several groups.

When the indicator processes a command, it either responds with a value (for reporting commands, or when querying parameter settings), or with the message **OK**. The **OK** response verifies the command was received and has been executed. If the command is unrecognized, the indicator responds with **?? invalid command**. If the command cannot be executed in the current mode, the indicator responds with **?? invalid mode**. If the command is recognized, but the value is out of range or the invalid type, the indicator responds with **??** followed by the type and the range.

7.1 Key Press Commands

Key press serial commands simulate pressing keys on the front panel of the indicator. These commands can be used in both setup and weigh mode. Several of the commands serve as pseudo keys, providing functions which are not represented by a key on the front panel.

For example, to enter a 15 lb tare weight using serial commands:

1. Type **K1** and press **Enter** (or **Return**).
2. Type **K5** and press **Enter**.
3. Type **KTARE** and press **Enter**.

Command	Function
KZERO	In weigh mode, this command acts like pressing the Zero key
KGROSSNET	In weigh mode, this command acts like pressing the Gross/Net key
KGROSS	Displays Gross mode (pseudo key)
KNET	Displays Net mode (pseudo key)
KTARE	In weigh mode, this command acts like pressing the Tare key
KUNITS	In weigh mode, this command acts like pressing the Units key
KPRIM	Displays primary units (pseudo key)
KSEC	Displays secondary units (pseudo key)
KPRINT	In weigh mode, this command acts like pressing the Print key
KPRINTACCUM	Prints the accumulated weight
KDISPACCUM	Displays the accumulator value
KDISPTARE	Displays the tare value
KCLR	In weigh mode, this command acts like pressing the Clear key
KCLRCN	Clears consecutive number
KCLRTAR	Clears the tare from the system (pseudo key)
KLEFT	In setup mode, this command moves Left in the menu
KRIGHT	In setup mode, this command moves Right in the menu
KUP	In setup mode, this command moves Up in the menu
KDOWN	In setup mode, this command moves Down in the menu
KEXIT	In setup mode, this command exits to weigh mode
KSAVE	In setup mode, this command saves the current configuration
KSAVEEXIT	In setup mode, this command saves the current configuration and exits to weigh mode
KTIME	Displays time
KDATE	Displays date
KTIMEDATE	Displays time and date
KCLRACCUM	Clears the accumulator

Table 7-1. Key Press Commands

Command	Function
Kn	This command acts like pressing numbers 0 (zero) through 9
KDOT	This command acts like pressing the decimal point (.)
KENTER	This command acts like pressing the Enter key
KYBDLK	In setup mode, this command locks the keys, except for the Menu key
KLOCK=x	In setup mode, this command locks specified front panel key; x = KPRINT, KUNITS, KTARE, KGROSSNET, KZERO, K0-K9, KDOT, KCLEAR (example: to lock the Zero key, enter KLOCK=KZERO)
KUNLOCK=x	In setup mode, this command unlocks specified front panel key; x = KPRINT, KUNITS, KTARE, KGROSSNET, KZERO, K0-K9, KDOT, KCLEAR (example: to unlock the Print key, enter KUNLOCK=KPRINT)

Table 7-1. Key Press Commands (Continued)

7.2 Reporting Commands

Reporting commands send specific information to the communications port. The commands listed in Table 7-2 can be used in either setup mode or weigh mode.

Command	Function
DUMPALL	Returns a list of all parameter values
DUMPAUDIT	Returns the Audit Trail information
KDUMPAUDIT	Returns the Audit Trail information on the same port which the EDP command was sent
AUDIT.LRVERSION	Returns the legally relevant firmware version
AUDIT.CONFIG	Returns the number of times configuration has changed
AUDIT.CALIBRATE	Returns the number of calibrations
AUDITJUMPER	Returns the position of the audit jumper (ON or OFF)
SPDUMP	Returns a list of the setpoint parameter values
VERSION	Returns the firmware version
HARDWARE	Returns the option card installed
HWSUPPORT	Returns the CPU board part number
RTCBATTERYSTATUS	Returns the status of the real time clock battery (GOOD or BAD)

Table 7-2. Reporting Commands

7.3 Reset Configuration Command

The following command can be used to reset the configuration parameters of the 680.

Command	Function
RESETCONFIGURATION	Restores all configuration parameters to default values (setup mode only)

Table 7-3. Reset Configuration Command



Note All scale calibration settings are lost when the **RESETCONFIGURATION** command is run.

7.4 Parameter Setting Commands

Parameter setting commands allow the current value for a configuration parameter to be displayed or changed. Current configuration parameter settings can be displayed in setup mode or weigh mode using the following syntax:
command<ENTER>

Most parameter values can be changed in setup mode only; setpoint parameters listed in [Table 7-10 on page 50](#) can be changed when in normal weigh mode.

Use the following command syntax when changing parameter values: command=value<ENTER>, where **value** is either a number or a parameter value. Use no spaces before or after the equal (=) sign. If an incorrect command is typed or an invalid value is specified, the indicator returns ?? followed by the error message.

Example: to set the motion band parameter on Scale #1 to 5 divisions, type the following:

SC.MOTBAND#1=5<ENTER>

To return a list of the available values for parameters with specific values, enter the command and equal sign, followed by a questions mark (command=?<ENTER>). The indicator must be in setup mode to use this function.

After changes are made to configuration parameters using EDP commands, use the **KSAVE** or **KSAVEEXIT** commands to commit the changes to memory.



Note

The user must stop the current batch for new values to take effect.

Command	Description	Values
SC.CAPACITY#n	Scale capacity	0.0000001–9999999.0, 10000.0 (default)
SC.ZTRKBN#n	Zero track band (in display divisions)	0.0–100.0, 0.0 (default)
SC.ZRANGE#n	Zero range (%)	0.0–100.0, 1.9 (default)
SC.MOTBAND#n	Motion band (in display divisions)	0–100, 1 (default)
SC.SSTIME#n	Standstill time (in 0.1 second intervals; 10 = 1 second)	0–600, 10 (default)
SC.OVERLOAD#n	Overload	FS+2% (default), FS+1D, FS+9D, FS
SC.WMTTHR#n	Weighment threshold	0.0–9999999.0, 1000.0 (default)
SC.NUMWEIGH#n	Number of weighments	0–4294967295 (uint_32_t_max), 0 (default)
SC.MAX_WEIGHT#n	Maximum weighment	-9999999–9999999, 0 (default)
SC.MAX_DATE#n	Date of maximum weighment	Up to 25 alphanumeric characters
SC.DIGFLTR1#n SC.DIGFLTR2#n SC.DIGFLTR3#n	Number of A/D samples averaged for the individual stages (1-3) of the three stage digital filter	1, 2, 4, 8 (default), 16, 32, 64, 128, 256
SC.DFSENS#n	Digital filter cutout sensitivity	2OUT (default), 4OUT, 8OUT, 16OUT, 32OUT, 64OUT, 128OUT
SC.DFTHR#n	Digital filter cutout threshold	NONE (default), 2D, 5D, 10D, 20D, 50D, 100D, 200D, 250D
SC.RATLTRAP#n	Rattletrap filtering	OFF (default), ON
SC.SMPRAT#n	Scale A/D sample rate	6.25HZ, 7.5HZ, 12.5HZ, 15HZ, 25HZ, 30HZ (default), 50HZ, 60HZ, 100HZ, 120HZ
SC.PWRUPMD#n	Power up mode	GO (default), DELAY
SC.TAREFN#n	Tare function	BOTH (default), KEYED, NOTARE, PBTARE
SC.PRI.FMT#n	Primary units format (decimal point and display divisions)	8888100, 8888200, 8888500, 8888810, 8888820, 8888850, 8888881 (default), 8888882, 8888885, 888888.1, 888888.2, 888888.5, 88888.81, 88888.82, 88888.85, 8888.881, 8888.882, 8888.885, 888.8881, 888.8882, 888.8885, 88.88881, 88.88882, 88.88885, 8.888881, 8.888882, 8.888885
SC.PRI.UNITS#n	Primary units	LB (default), KG, OZ, TN, T, G, CUSTOM, NONE
SC.SEC.FMT#n	Secondary units format (decimal point and display divisions)	8888100, 8888200, 8888500, 8888810, 8888820, 8888850, 8888881, 8888882, 8888885, 888888.1, 888888.2, 888888.5 (default), 88888.81, 88888.82, 88888.85, 8888.881, 8888.882, 8888.885, 888.8881, 888.8882, 888.8885, 88.88881, 88.88882, 88.88885, 8.888881, 8.888882, 8.888885
SC.SEC.UNITS#n	Secondary units	LB, KG (default), OZ, TN, T, G, CUSTOM, NONE

For commands ending with #n, n is the scale number (1)

Table 7-4. Scales Commands

Command	Description	Values
SC.SEC.ENABLED#n	Enable the Secondary Units	ON (default), OFF
SC.FILTERCHAIN#n	Defines what filter to use	AVGONLY (default), ADPONLY, DMPONLY, RAW
SC.DAMPINGVALUE#n	Sets the damping time constant	0–2560 (in 0.1 second intervals), 0 (default)
SC.ADTHRESHOLD#n	Adaptive filter weight threshold value	0–2000 (in display divisions), 10 (default)
SC.ADSENSITIVITY#n	Adaptive filter sensitivity	LIGHT (default), MEDIUM, HEAVY
SC.ACCUM#n	Accumulator enable	OFF (default), ON
SC.WZERO#n	Perform zero calibration	—
SC.TEMPZERO#n	Perform temporary zero calibration	—
SC.LASTZERO#n	Perform last zero calibration	—
SC.WVAL#n	Test weight value	0.000001–9999999.999999, 10000.0 (default)
SC.WSPAN#n	Perform span calibration	—
SC.WLIN.F1#n– SC.WLIN.F4#n	Actual raw count value for linearization points 1–4	0–16777215, 0 (default)
SC.WLIN.V1#n– SC.WLIN.V4#n	Test weight value for linearization points 1–4 (A setting of 0 indicates the linearization point is not used)	0.000001–9999999.999999, 0.0 (default)
SC.WLIN.C1#n– SC.WLIN.C4#n	Perform linearization calibration on points 1–4	—
SC.LC.CD#n	Deadload coefficient raw count value	0–16777215, 8386509 (default)
SC.LC.CW#n	Span coefficient raw count value	0–16777215, 2186044 (default)
SC.LC.CZ#n	Temporary zero raw count value	0–16777215, 2186044 (default)
SC.REZERO#n	Perform the Rezero calibration function	—
SC.INITIALZERO#n	Initial Zero range in % of full scale	0.0–100.0, 0.0 (default)
SC.RTZGRAD#n	Number of graduations from the zero base at which the accumulator re-arms itself	0.0–100.0, 0.4 (default)
For commands ending with #n, n is the scale number (1)		

Table 7-4. Scales Commands (Continued)

7.5 EDP Setting Commands

Command	Description	Values
EDP.INPUT#p	Port serial input function	CMD (default), STRIND, STRLFT, REMOTE
EDP.BAUD#p	Port baud rate	1200, 2400, 4800, 9600 (default), 19200, 38400, 57600, 115200
EDP.BITS#p	Port data bits/parity	8NONE (default), 7EVEN, 7ODD
EDP.TERMIN#p	Port line termination character	CR/LF (default), CR
EDP.STOPBITS#p	Port stop bits	1 (default), 2
EDP.ECHO#p	Port echo	ON (default), OFF
EDP.RESPONSE#p	Port response	ON (default), OFF
EDP.EOLDLY#p	Port end-of-line delay	0–255 (0.1-second intervals), 0 (default)
EDP.HANDSHK#p	Port handshake	OFF (default), XONXOFF, HRDWAR
EDP.ADDRESS#p	Port RS-485 address	0–255, 0 (default)
For commands ending with #p, p is the port number (1-5)		

Table 7-5. Serial Port Commands

CPU Ports

- Ports 1 and 2 are the two RS-232 ports
- Port 3 is the RS-485/422 port
- Port 4 is the USB device port
- Port 5 is the Ethernet port

For ports 4 (USB) and 5 (Ethernet), the only applicable parameters are INPUT, TERMIN, ECHO, RESPONSE, EOLDLY. All other parameters are ignored.

7.6 Internet Setting Commands

Command	Description	Values
WIRED.MACID	Ethernet hardware MAC ID (read only)	xx:xx:xx:xx:xx:xx, 00:00:00:00:00:00 (default)
WIRED.DHCP	Enable Ethernet DHCP	ON (default), OFF
WIRED.ENABLED	Enable wired Ethernet adapter	ON, OFF (default)
WIRED.IPADDR	Ethernet IP address	Valid IP xxx.xxx.xxx.xxx*, 0.0.0.0 (default)
WIRED.SUBNET	Ethernet subnet mask	Valid IP xxx.xxx.xxx.xxx*, 255.255.255.0 (default)
WIRED.GATEWAY	Ethernet gateway	Valid IP xxx.xxx.xxx.xxx*, 0.0.0.0 (default)
TCPC1.ECHO	TCP Client 1 echo	ON (default), OFF
TCPC1.EOLDLY	TCP Client 1 end-of-line delay	0–255 (in 0.1 sec intervals), 0 (default)
TCPC1.IPADDR	TCP Client 1 remote server IP	Valid IP xxx.xxx.xxx.xxx*, 0.0.0.0 (default)
TCPC1.LINETERM	TCP Client 1 line termination	CR/LF (default), CR
TCPC1.NAME	TCP Client 1 name	Up to 16 alphanumeric characters, TCPC1 (default)
TCPC1.PORT	TCP Client 1 remote server port	1025–65535, 10001 (default)
TCPC1.RESPONSE	TCP Client 1 response	ON (default), OFF
TCPC1.DISCTIME	TCP Client 1 disconnect time (in seconds)	0–60 (0= do not disconnect), 0 (default)
TCPC1.INPUT	TCP Client 1 input function	CMD (default), STRIND, STRLFT, REMOTE
TCPS.ECHO	TCP Server echo	ON (default), OFF
TCPS.INPUT	TCP Server input type	CMD (default)
TCPS.LINETERM	TCP Server line termination	CR/LF (default), CR
TCPS.NAME	TCP Server name	Up to 16 alphanumeric characters, TCPS (default)
TCPS.PORT	TCP Server port number	1025–65535, 10001 (default)
TCPS.RESPONSE	TCP Server response	ON (default), OFF
USB.INPUT	USB input function	CMD (default), STRIND, STRLFT, REMOTE
USB.LINETERM	USB line terminator	CR/LF (default), CR
USB.ECHO	USB echo	ON (default), OFF
USB.RESPONSE	USB response	ON (default), OFF
USB.EOLDLY	USB end of line delay	0–255, 0 (default)
USB.PRINTMSG	USB print message	ON (default), OFF

* A valid IP consists of four numbers, in the range of 0 to 255, separated by a decimal point (127.0.0.1 and 192.165.0.230 are valid IP addresses)

Table 7-6. Ethernet TCP/IP and Wi-Fi Commands

7.7 Stream Setting Commands

Command	Description	Values
STRM.FORMAT#n	Stream format	RLWS (default), CARDNAL, WTRONIX, TOLEDO, CUSTOM
STRM.CUSTOM#n	Custom stream definition	Up to 1000 alphanumeric characters
STRM.GROSS#n	Mode token when streaming the Gross weight	Up to 8 alphanumeric characters, G (default)
STRM.NET#n	Mode token when streaming the Net weight	Up to 8 alphanumeric characters, N (default)
STRM.PRI#n	Units token when streaming Primary units	Up to 8 alphanumeric characters, L (default)
STRM.SEC#n	Units token when streaming Secondary units	Up to 8 alphanumeric characters, K (default)
STRM.INVALID#n	Status token when streaming an Invalid weight	Up to 2 alphanumeric characters, I (default)
STRM.MOTION#n	Status token when the weight is in motion	Up to 2 alphanumeric characters, M (default)
STRM.POS#n	Polarity token when the weight is positive	SPACE (default), NONE, +
STRM.NEG#n	Polarity token when the weight is negative	SPACE, NONE, – (default)
STRM.OK#n	Status token when the weight is OK (not invalid, out of range, at zero, or in motion)	Up to 2 alphanumeric characters
STRM.TARE#n	Mode token when streaming the tare weight	Up to 8 alphanumeric characters, T (default)
STRM.RANGE#n	Status token when the weight is Out of Range	Up to 2 alphanumeric characters, O (default)
STRM.ZERO#n	Status token when the weight is at Center of Zero	Up to 2 alphanumeric characters, Z (default)

For commands ending with #n, n is the stream format number (1)

Table 7-7. Stream Formatting Commands

7.8 Feature Commands

Command	Description	Values
DATEFMT	Date format	MMDDYY (default), DDMMYY, YYMMDD, YYDDMM
DATESEP	Date separator	SLASH (default), DASH, SEMI, DOT
TIMEFMT	Time format	12HOUR (default), 24HOUR
TIMESEP	Time separator	COLON (default), COMMA, DOT
CONSNUM	Consecutive numbering	0–9999999, 0 (default)
CONSTUP	Consecutive number start-up value	0–9999999, 0 (default)
UID	ID of the indicator	Up to 6 alphanumeric characters, 1 (default)
KYBDLK	Keyboard lock (disable keypad)	OFF (default), ON
ZERONLY	Disable all keys except ZERO	OFF (default), ON
CONTACT.COMPANY	Contact company name	Up to 30 alphanumeric characters
CONTACT.ADDR1-3	Contact company address	Up to 30 alphanumeric characters (for each line)
CONTACT.NAME1-3	Contact names	Up to 30 alphanumeric characters (for each line)
CONTACT.PHONE1-3	Contact phone numbers	Up to 30 alphanumeric characters (for each line)
CONTACT.EMAIL	Contact e-mail address	Up to 30 alphanumeric characters.
CONTACT.NEXTCAL	Next calibration date	Date MMDDYYYY as an 8-digit number.
CONTACT.LASTCAL	Last calibration date	Date MMDDYYYY as an 8-digit number.
LOCALE	Enable gravity compensation	OFF (default), ON
LAT.LOC	Origin latitude (to nearest degree) for gravity compensation	0–90, 45 (default)
ELEV.LOC	Origin elevation (in meters) for gravity compensation	-9999–9999, 345 (default)
DEST.LAT.LOC	Destination latitude (in degrees) for gravity compensation	0–90, 45 (default)
DEST.ELEV.LOC	Destination elevation (in meters) for gravity compensation	-9999–9999, 345 (default)

Table 7-8. Feature Commands

7.9 Regulatory Commands

Command	Description	Values
REGULAT	Regulatory mode	NTEP (default), CANADA, INDUST, NONE, OIML
AUDAGNCY	Audit Agency (Industrial Mode)	NTEP (default), CANADA, NONE, OIML
REG.SNPSHOT	Display or Scale weight source	DISPLAY (default), SCALE
REG.HTARE	Allow tare in display hold	NO (default), YES
REG.ZTARE	Remove tare on ZERO	NO (default), YES
REG.KTARE	Always allow keyed tare	NO, YES (default)
REG.MTARE	Multiple tare action	REPLACE (default), REMOVE, NOTHING
REG.NTARE	Allow negative tare	NO (default), YES
REG.CTARE	Allow Clear key to clear tare/accumulator	NO, YES (default)
REG.NEGTOTAL	Allow total scale to display negative value	NO (default), YES
REG.PRTMOT	Allow print while in motion	NO (default), YES
REG.PRINTPT	Add PT to keyed tare print	NO, YES (default)
REG.PRTHLD	Print during display hold	NO (default), YES
REG.HLDWGH	Allow weighment during display hold	NO (default), YES
REG.MOTWGH	Allow weighment in motion	NO (default), YES
REG.OVRBASE	Zero base for overload calculation	CALIB (default), SCALE
REGWORD	Regulatory word	GROSS (default), BRUTTO
REG.RTARE	Round the Pushbutton Tare	NO (default), YES
REG.RKTARE	Round the Keyed Tare	NO (default), YES
REG.AZTNET	Perform AZT on Net value	NO (default), YES
REG.MANUALCLEARTARE	Allows manual clearing of the tare value	NO, YES (default)
REG.TAREINMOTION	Allows Tare in Motion	NO (default), YES
REG.ZEROINMOTION	Allows scale to be zeroed while in motion	NO (default), YES
REG.UNDERLOAD	Underload weight value in display divisions	1–9999999, 20 (default)

Table 7-9. Regulatory Commands

7.10 Setpoint Commands

Command	Description	Values
BATCHNG	Batching mode	OFF (default), AUTO, MANUAL
SP.KIND#n	Setpoint kind	OFF (default), GROSS, NET, -GROSS, -NET, ACCUM, POSREL, NEGREL, PCTREL, PAUSE, DELAY, WAITSS, COUNTER, AUTOJOG, COZ, INMOTON, INRANGE, BATCHPR, TIMER, CONCUR, TOD, ALWAYS, NEVER
SP.VALUE#n	Setpoint value	0.0–9999999.0, 0.0 (default)
SP.TRIP#n	Trip	HIGHER (default), LOWER, INBAND, OUTBAND
SP.BANDVAL#n	Band value	0.0–9999999.0, 0.0 (default)
SP.HYSTER#n	Hysteresis	0.0–9999999.0, 0.0 (default)
SP.PREACT#n	Preact type	OFF (default), ON, LEARN
SP.PREVAL#n	Preact value	0.0–9999999.0, 0.0 (default)
SP.PREADJ#n	Preact adjustment percentage	0.0–100.0, 0.5 (default)
SP.PRESTAB#n	Preact learn stability (in tenths of a second)	0–65535, 0 (default)
SP.PCOUNT#n	Preact learn interval	1–65535, 1 (default)
SP.BATCH#n	Batch step enable	OFF (default), ON
SP.CLRACCM#n	Clear accumulator enable	OFF (default), ON
SP.CLRTARE#n	Clear tare enable	OFF (default), ON
SP.PSHACCM#n	Push accumulate	OFF (default), ON, ONQUIET
SP.PSHPRINT#n	Push print	OFF (default), ON, WAITSS
SP.PSHTARE#n	Push tare	OFF (default), ON
SP.ALARM#n	Alarm enable	OFF (default), ON
SP.ALIAS#n	Setpoint name	Up to 8 alphanumeric characters, SETPT (default)
SP.ACCESS#n	Setpoint access	OFF, ON (default), HIDE
SP.DSLOT#n	Digital output slot	NONE (default), 0
SP.DIGOUT#n	Digital output	1–4, 1 (default)
SP.SENSE#n	Digital output sense	NORMAL (default), INVERT
SP.BRANCH#n	Branch destination (0 = do not branch)	0–8, 0 (default)
SP.RELNUM#n	Relative setpoint number	1–8, 1 (default)
SP.START#n	Starting setpoint	1–8, 1 (default)
SP.END#n	Ending setpoint	1–8, 1 (default)
SP.TIME#n	Trip time	hhmm, 0000 (default)
SP.DURATION#n	Trip duration	hhmmss, 000000 (default)
SP.ENABLE#n	Setpoint enable	OFF, ON (default)

For setpoint commands ending with #n, n is the setpoint number (1-8)

Table 7-10. Setpoints Commands

7.11 Print Format Commands

Command	Description	Values
GFMT GFMT.PORT GFMT.PORT2	Gross demand print format string	Each format can be sent out one or two ports; for the .PORT and .PORT2 commands, specify the port name as one of the following: RS232-1, RS232-2, RS485, TCPC, USB, NONE
NFMT NFMT.PORT NFMT.PORT2	Net demand print format string	<i>Example: To send the Gross format out both RS-232 Port 2 and the TCPC Port at the same time, send:</i> GFMT.PORT=RS232-1 GFMT.PORT2=USB See Section 8.0 on page 53 for information about demand print format strings
ACCFMT ACC.PORT ACC.PORT2	Accumulator print format string	
SPFMT SPFMT.PORT SPFMT.PORT2	Setpoint print format string	
HDRFMT1 HDRFMT2	Ticket header format strings	
AUD.DEST1 AUD.DEST2	Audit trail port	

Table 7-11. Print Format Commands

7.12 Digital I/O Commands

Command	Description	Values
DIO. <i>b</i> # <i>s</i>	Sets DIO type	OFF (default), OUTPUT, PRIM, PRINT, SEC, TARE, UNITS, ZERO, BATRUN, BATSTRT, BATPAUS, BATRESET, BATSTOP, CLEAR, CLRACC, CLRCN, CLRTAR, DSPACC, DSPTAR, GROSS, KBDLOC, NET, NT/GRS
Valid bit values (<i>b</i>) are 1-4; For commands ending with # <i>s</i> , <i>s</i> is the slot assigned to the digital I/O (0); Slot 0 is onboard		

Table 7-12. Digital I/O Commands

7.13 Analog Output Commands

Command	Description	Values
ALG.SOURCE# <i>s</i>	Analog output source	SCALE1 (default), REMOTE
ALG.MODE# <i>s</i>	Mode	GROSS (default), NET
ALG.OUTPUT# <i>s</i>	Type of output	0-10V (default), 0-20MA, 4-20MA
ALG.ERRACT# <i>s</i>	Error action	FULLSC (default), HOLD, ZEROSC
ALG.MIN# <i>s</i>	Minimum value tracked	±9999999.0, 0.0 (default)
ALG.MAX# <i>s</i>	Maximum value tracked	±9999999.0, 10000.0 (default)
For commands ending with # <i>n</i> , <i>n</i> is the slot number assigned to the analog output (1)		

Table 7-13. Analog Output Commands

7.14 Weigh Mode Commands

These commands function in the weigh mode. Non weight related commands work in setup mode.

Command	Description	Values
CONSNUM	Returns current consecutive number value	0–9999999, 0 (default)
UID	Set unit ID	Up to 6 alphanumeric characters, 1 (default)
SD	Set or return the current system date	<i>MMDDYY</i> , <i>DDMMYY</i> , <i>YYMMDD</i> , or <i>YYDDMM</i> . Enter six-digit date using the year-month-day order specified for the DATEFMT parameter, using only the last two digits of the year; The current system date is returned by only sending SD
ST	Set or return the current system time	<i>HHMM</i> (enter using 24-hour format) The current system time is returned by only sending ST
SX# <i>n</i>	Start serial data stream(s)	OK or ??
EX# <i>n</i>	Stop serial data stream(s)	An EX command sent while in setup mode does not take effect until the indicator is returned to weigh mode
RS	Reset system	Soft reset; Used to reset the indicator without resetting the configuration to the factory defaults
SF# <i>n</i>	Returns a single stream frame from scale <i>n</i> (<i>n</i> =1) using the standard Rice Lake format.	--
XA# <i>n</i>	Returns the accumulator value in displayed units	nnnnnnnn UU
XAP# <i>n</i>	Returns the accumulator value in primary units	
XAS# <i>n</i>	Returns the accumulator value in secondary units	
XG# <i>n</i>	Returns the gross weight in displayed units	nnnnnnnn UU
XGP# <i>n</i>	Returns the gross weight in primary units	
XGS# <i>n</i>	Returns the gross weight in secondary units	
XN# <i>n</i>	Returns the net weight in displayed units	nnnnnnnn UU
XNP# <i>n</i>	Returns the net weight in primary units	
XNS# <i>n</i>	Returns the net weight in secondary units	
XT# <i>n</i>	Returns the tare weight in displayed units	nnnnnnnn UU
XTP# <i>n</i>	Returns the tare weight in primary units	
XTS# <i>n</i>	Returns the tare weight in secondary units	

For commands ending with #*n*, *n* is the scale number (1)

Table 7-14. Weigh Mode Commands

7.15 Batching Control Commands

The commands listed in [Table 7-15](#) provide batching control through a communications port.

Command	Description	Values
BATSTART	Batch Start	If the BATRUN digital input is active or not assigned, the BATSTART command can be used to start the batch program
BATSTOP	Batch Stop	Stops an active batch and turns off all associated digital outputs; Requires a Batch Start to resume processing
BATPAUSE	Batch Pause	Pauses an active batch and turns off all digital outputs except those associated with Concurrent and Timer setpoints; processing is suspended until the indicator receives a Batch Start signal; pressing the BATSTRT digital input, BATSTART serial command, Batch Start softkey or the StartBatch function (in iRite) resumes the batch and re-energizes all digital outputs turned off by the Batch Pause
BATRESET	Batch Reset	Stops the program and resets the batch program to the first batch step; use the BATRESET command after making changes to the batch configuration
BATSTATUS	Batch Status	Returns <i>XXXX</i> where <i>X</i> is <i>S</i> (if the batch is stopped), <i>P</i> (if the batch is paused), <i>R</i> (if the batch is running); and <i>YYY</i> is the setpoint number the batch is currently on (1-8)

Table 7-15. Batching Control Commands

8.0 Print Formatting

The 680 provides multiple print formats, GFMT, NFMT, ACUMFMT, STPTFMT and HDRFMT, which determine the format of the printed output when the **Print** key is pressed. If a tare has been entered or acquired, NFMT is used; otherwise, GFMT is used.

Each print format can be customized to include up to 1000 characters of information, such as company name and address, on printed tickets. Use the print format menu through front panel of the indicator to customize the print formats.



Note Press the down arrow to view the ASCII character decimal value on the second menu level. See [Section 11.9 on page 69](#) to view the ASCII character chart.

8.1 Print Formatting Tokens

[Table 8-1](#) lists tokens which can be used to configure the print formats. Tokens included in the format strings must be enclosed between < and > delimiters. Characters outside of the delimiters are printed as text on the ticket. Text characters can include ASCII characters which can be printed by the output device.

Token	Description
<G>	Gross weight in displayed units
<G2>	Gross weight in non-displayed units***
<N>	Net weight in displayed units
<N2>	Net weight in non-displayed units***
<T>	Tare weight in displayed units
<T2>	Tare weight in non-displayed units***
<A>	Accumulated weight in displayed units
<AC>	Number of accumulator events (5 digit counter)
<AD>	Date of last accumulator event
<AT>	Time of last accumulator event
<UID>	Unit ID number
<CN>	Consecutive number
<NLnn>	New line (nn = number of termination (<CR/LF> or <CR>) characters)*
<SPnn>	Space (nn = number of spaces)*
<SU>	Toggle weight data format (formatted/unformatted)** ***
<TI>	Time
<DA>	Date (prints 4 digit year)
<TD>	Time & Date
<SCV>	Setpoint captured value
<STV>	Setpoint target value
<SPM>	Setpoint mode (Net or Gross)
<SN>	Setpoint number
Gross, net, and tare weights are 9 digits in length, including sign (10 digits with decimal point) followed by a space and a two-digit units identifier. Total field length with units identifier is 12 (or 13) characters.	
UID and consecutive number (CN) fields are 6 characters in length.	
* If nn is not specified, 1 is assumed. Value must be in the range 1–99.	
** After receiving an SU command, the indicator sends unformatted data until the next SU command is received. Unformatted data omits decimal points, and leading and trailing characters.	
*** Not available if regulatory mode is set to OIML.	

Table 8-1. Print Format Tokens

Table 8-2 lists the default 680 print formats:

Format	Default Format String	When Used
GFMT	GROSS<G><NL2><TD><NL>	Weigh mode – no tare in system
NFMT	GROSS<G><NL>TARE<SP><T><NL>NET<SP2><N><NL2><TD><NL>	Weigh mode – tare in system
ACUMFMT	ACCUM <A><NL><DA> <TI><NL>	Accumulator demand print format string
STPTFMT	<SCV><SP><SPM><NL>	Setpoint print operation with PSHPRNT=ON
HDRFMT1-2	COMPANY NAME<NL>STREET ADDRESS<NL>CITY ST ZIP<NL2>	

Table 8-2. Default Print Formats



Note

The <G2>, <N2> and <T2> tokens (Table 8-1) print the gross, net and tare weights in the units not currently displayed on the indicator.

The 1000 character limit of each print format string includes the output field length of the print formatting tokens, not the token length. For example, if the indicator is configured to display a decimal point, the <G> token generates an output field of 13 characters: the 10 character weight value (including decimal point), one space, and a two-digit units identifier.

PT (preset tare) is added to the tare weight if tare was keyed in.

8.2 Customizing Print Formats

The GFMT, NFMT, ACUMFMT, STPTFMT and HDRFMT formats can be customized using the print format menu (PF₀-F1) via the front panel. See Section 4.4.6 on page 33 for the print format menu structure. To access the print format menu the indicator must be in setup mode (Section 4.1 on page 22).

8.2.1 Using the Front Panel

Use the print format menu to customize the print formats and to edit the print format strings by changing the ASCII characters in the format string. See Section 3.3.2 on page 16 for the alphanumeric entry procedure to edit the print format string.



Note

Some characters cannot be displayed on the 680 front panel, see the ASCII character chart in Section 11.9 on page 69 for available characters. The 680 can send or receive ASCII characters; the character printed depends on the particular ASCII character set implemented for the receiving device.

9.0 Setpoints

The 680 indicator provides eight configurable setpoints for control of both indicator and external equipment functions. Setpoints can be configured to perform actions or functions based on specified parameter conditions. Parameters associated with various setpoint kinds can, for example, be configured to perform functions (print, tare, accumulate), to change the state of a digital output controlling indicator or external equipment functions, or to make conditional decisions.



Note *Weight-based setpoints are tripped by values specified in primary units only.*

9.1 Batch and Continuous Setpoints

680 setpoints can be either continuous or batch.

Continuous setpoints are free-running; the indicator constantly monitors the condition of free-running setpoints at each A/D update. The specified setpoint action or function is performed when the designated setpoint parameter conditions are met. A digital output or function assigned to a free-running setpoint continuously changes state, becoming active or inactive, as defined by the setpoint parameters.

Batch setpoints (BATCH = ON) which have digital outputs associated to them remain active until the setpoint condition is met. The setpoint is then latched for the remainder of the batch sequence.

To use batch setpoints, set the batching (BATCHNG) parameter on the setpoints (SETPTS) menu. This parameter defines whether a batch sequence is automatic or manual. AUTO sequences repeat continuously after receiving a single batch start signal, while MANUAL sequences only run through once for each Batch Start signal. The batch start signal can be initiated by a digital input (set to BATSTR), or an EDP command (BATSTART).

For a setpoint to be used as part of a batch sequence, its batch sequence (BATCH) parameter must be set to ON. If a setpoint is defined and enabled, but its Batch Sequence parameter is set to OFF, the setpoint operates as a continuous setpoint even during batch sequences.



Note *In applications which contain both batch setpoint routines and continuous setpoints, it is good practice to keep continuous setpoints separate from the batch sequence.*

Do not assign them the same digital output.

Set the ACCESS parameter ON when creating and testing batch routines. Once the batching routine is complete and ready for production, ACCESS can be set to OFF to prevent changes to the configured setpoint value, or to HIDE to prevent changing or viewing the value.

Parameter	Description	Batch	Continuous
OFF	Off – Setpoint turned off/ignored		
GROSS	Gross Weight – Performs functions based on the gross weight; the target weight entered is considered a positive gross weight	X	X
NET	Net Weight – Performs functions based on the net weight; the target weight entered is considered a positive net weight value	X	X
-GROSS	Negative Gross Weight – Performs functions based on the gross weight; the target weight entered is considered a negative gross weight	X	X
-NET	Negative Net Weight – Performs functions based on the net weight; the target weight entered is considered a negative net weight value	X	X
ACCUM	Accumulate – Compares the value of the setpoint to the source scale accumulator; the accumulator setpoint is satisfied when the value of the source scale accumulator meets the value and conditions of the accumulator setpoint	X	X
POSREL	Positive Relative – Performs functions based on a specified value above a referenced setpoint, using the same weight mode as the referenced setpoint	X	X
NEGREL	Negative Relative – Performs functions based on a specified value below a referenced setpoint, using the same weight mode as the referenced setpoint	X	X

Table 9-1. Setpoint Kinds

Parameter	Description	Batch	Continuous
PCTREL	Percent Relative – Performs functions based on a specified percentage of the target value of a referenced setpoint, using the same weight mode as the referenced setpoint; the actual target value of the Percent Relative setpoint is calculated as a percentage of the target value of the referenced setpoint	X	X
PAUSE	Pause – Pauses the batch sequence indefinitely; a Batch Start signal must be initiated to continue the batch process	X	
DELAY	Delay – Delays the batch sequence for a specified time; the length of the delay (in tenths of a second) is specified on the Value parameter	X	
WAITSS	Wait Standstill – Suspends the batch sequence until the scale is at standstill	X	
COUNTER	Counter – Specifies the number of consecutive batch sequences to perform; place counter setpoints at the beginning of a batch routine	X	
AUTOJOG	<p>Auto-Jog – Automatically checks the previous weight-based setpoint to verify the setpoint weight value is satisfied in a standstill condition</p> <ul style="list-style-type: none"> If the previous setpoint is not satisfied when at standstill, the AUTOJOG setpoint activates the digital output of the previous weight-based setpoint for a period of time, specified on the Value parameter (in tenths of a second) The AUTOJOG process repeats until the previous weight-based setpoint is satisfied when the scale is at standstill <p>NOTE: The AUTOJOG digital output is typically used to signify an AUTOJOG operation is being performed.</p> <p>NOTE: AUTOJOG uses the digital output of the previous weight-based setpoint, and should not be assigned to the same digital output as the related weight-based setpoint.</p>	X	
COZ	<p>Center of Zero – Monitors for a gross center of zero condition</p> <ul style="list-style-type: none"> The digital output associated with this setpoint kind is activated when the referenced scale is at center of zero No value is required for this setpoint 		X
INMOTON	<p>In-Motion – Monitors for an in-motion condition</p> <ul style="list-style-type: none"> The digital output associated with this setpoint is activated when the scale is not at standstill. No value is required for this setpoint 		X
INRANGE	<p>In-Range – Monitors for an in-range condition</p> <ul style="list-style-type: none"> The digital output associated with this setpoint is activated when the scale is within capacity range No value is required for this setpoint 		X
TIMER	<p>Timer – Tracks the progress of a batch sequence based on a timer</p> <ul style="list-style-type: none"> The timer value, in tenths of a second, determines the length of time allowed between start and end setpoints Start and End parameters are used to specify the start and end setpoints If the End setpoint is not reached before the timer expires, the digital output associated with this setpoint is activated 		X
CONCUR	<p>Concurrent – Allows a digital output to remain active over a specified portion of the batch sequence</p> <ul style="list-style-type: none"> Type 1 (VALUE=0): The digital output associated with this setpoint becomes active when the Start setpoint becomes the current batch step and remains active until the End setpoint becomes the current batch step Type 2 (VALUE > 0): If a non-zero value is specified for the Value parameter, the value represents the timer, in tenths of a second, for this setpoint; the digital output associated with this setpoint becomes active when the Start setpoint becomes the current batch step and remains active until the timer expires 		X
TOD	Time of Day – Performs functions when the internal clock time of the indicator matches the specified setpoint time	X	X
ALWAYS	Always – This setpoint is always satisfied; it is typically used to provide an endpoint for true/false branching batch routines	X	
NEVER	<p>Never – This setpoint is never satisfied</p> <ul style="list-style-type: none"> Used to branch to a designated setpoint in true/false branching batch routines in which the batch does not continue through the normal sequence of batch setpoints 	X	

Table 9-1. Setpoint Kinds (Continued)

9.2 Batching Examples

9.2.1 Example 1

The following example uses seven setpoints to dispense material from a hopper in 100 lb batches and to automatically refill the hopper when its weight drops below 300 lb.

Bits 1 and 2 in the Digital I/O menu ([Section 4.4.9 on page 38](#)) are assigned to batch start and batch run functions: BATRUN must be on (low) before the BATSTRT input starts the batch.

```
SLOT 0, BIT 1=BATSTRT
SLOT 0, BIT 2=BATRUN
BATCHNG=MANUAL
```

Setpoint 1 ensures the hopper has enough material to start the batch. If the hopper weight is 300 lb or higher, setpoint 1 is tripped.

```
SETPT 1
KIND=GROSS
VALUE=300
TRIP=HIGHER
ALARM=ON
BATCH=ON
```

Setpoint 2 waits for standstill, then performs a tare to put the indicator into net mode.

```
SETPT 2
KIND=WAITSS
PSHTARE=ON
```

Setpoint 3 is used as a reference (relative setpoint) for setpoint 4.

```
SETPT 3
KIND=NET
VALUE=0
TRIP=HIGHER
BATCH=OFF
```

Setpoint 4 is used to dispense material from the hopper. When the hopper weight falls to 100 lb less than its weight at the relative setpoint (setpoint 3), digital output 1 is set off.

```
SETPT 4
KIND=NEGREL
VALUE=100
TRIP=LOWER
DIG OUT=1
BATCH=ON
RELNUM=3
```

Setpoint 5 is used to evaluate the gross amount of material in the hopper after dispensing, and to maintain a minimum material level in the hopper. When the hopper weight falls below 300 lb, digital output 2 becomes active and the hopper is refilled to 1000 lb.

```
SETPT 5
KIND=GROSS
VALUE=300
TRIP=HIGHER
HYSTERS=700
DIG OUT=2
BATCH=ON
```

Setpoint 6 is used to ensure the operation performed in setpoint 4 is completed within 10 seconds. The START and END parameters identify the setpoints monitored by the timer. If the timer expires before setpoint 5 starts, digital output 4 is turned on as an alarm to signal a process fault.

```
SETPT 6
KIND=TIMER
VALUE=100
START=4
END=5
DIG OUT=4
```

9.2.2 Example 2

The following example uses six setpoints to control a two-speed fill operation where both fast and slow feeds are on simultaneously.

Bits 1 and 2 in the Digital I/O menu ([Section 4.4.9 on page 38](#)) are assigned to batch start and batch run functions: BATRUN must be on (low) before the BATSTRT input starts the batch.

```
SLOT 0, BIT 1=BATSTRT
SLOT 0, BIT 2=BATRUN
BATCHNG=MANUAL
```

Setpoint 1 ensures the scale is empty (0 ± 2 lb).

```
SETPT 1
KIND=GROSS
VALUE=0
TRIP=INBAND
BANDVAL=2
BATCH=ON
```

Setpoint 2 checks for the weight of a container (>5 lb) placed on the scale.

```
SETPT 2
KIND=GROSS
VALUE=5
TRIP=HIGHER
BATCH=ON
```

Setpoint 3 waits for standstill, then tares the container weight, placing the indicator in net mode.

```
SETPT 3  
KIND=WAITSS  
PSHTARE=ON
```

Setpoint 4 starts the fast fill operation. When the net weight reaches 175 lb, the setpoint trips and digital output 1 is set off.

```
SETPT 4  
KIND=NET  
VALUE=175  
TRIP=HIGHER  
DIG OUT=1  
BATCH=ON
```

Setpoint 5 controls the slow fill operation. When the net weight reaches 200 lb, the slow fill is stopped, the indicator waits for standstill and performs a push print operation using the SPFMT ticket format.

```
SETPT 5  
KIND=NET  
VALUE=200  
TRIP=HIGHER  
PSHPRNT=WAITSS  
DIG OUT=2  
BATCH=ON
```

Setpoint 6 is a continuous setpoint, used to allow the slow feed output to be on at the same time as the fast fill. The slow fill output (digital output 2) is turned on when setpoint 4 (fast fill) starts and remains on until setpoint 5 begins.

```
SETPT 6  
KIND=CONCUR  
VALUE=0  
START=4  
END=5  
DIG OUT=2
```

10.0 Maintenance

The maintenance information in this manual is designed to cover aspects of maintaining and troubleshooting the 680 indicator. Contact the local Rice Lake Weighing Systems dealer if a problem requires technical assistance.



Note Have the scale model number and serial number available when calling for assistance.

10.1 Maintenance Checkpoints

The scale must be checked frequently to determine when a calibration is required. It is recommended a zero calibration be checked every other day and a calibration checked every week for several months after installation. Observe the results and change the period between calibration checks, depending upon the accuracy desired.



Note Establish a routine inspection procedure. Report changes in the scale function to the individual or department responsible for the scales' performance.

10.2 Field Wiring

If a problem with the wiring is suspected, check the electrical portion of the scale.

- Check for proper interconnections between the components of the system
- Check wiring meets all specifications in the installation drawings
- Check all wiring and connections for continuity, shorts and grounds using an ohmmeter with the scale off
- Check for loose connections, poor solder joints, shorted or broken wires and unspecified grounds in wiring; these issues cause erratic readings and shifts in weight readings
- Check all cable shields to ensure grounding is made at only the locations specified in the installation drawings

10.3 Troubleshooting Tips

Table 10-1 lists general troubleshooting tips for hardware and software error conditions

Symptom	Possible Cause	Remedy
680 does not power up	Bad power supply	Check power supply; Check presence of AC power – breaker tripped or unit unplugged; Power supply outputs around 12 VDC – replace if bad
Battery backed corrupt error message at startup	Dead battery	Perform configuration reset then check for low battery warning on display; If battery is low, replace battery, perform another configuration reset, then reload files/configuration
nnnnnnnn or uuuuuuuu	Over or under range scale condition	Check scale; For out-of-range conditions in total scale display, check all scale inputs for positive weight values
Display reads 0.000000	Scale not updating	Make sure all cables/wires are connected for the pulse input and/or load cell; Cycle the power
Cannot enter setup mode	Bad switch	Test switch
Serial port not responding	Configuration error	Ensure port INPUT parameter is set to CMD for command input
A/D scale out of range	Scale operation Load cell connection Bad load cell	Check source scale for proper mechanical operation Check load cell and cable connection Check 680 operation with load cell simulator Check status of sense settings
Option card failure	Possible defective card or slot	Disconnect power, remove and reinstall card in slot, then apply power again

Table 10-1. Basic Troubleshooting

10.4 Battery Replacement

The battery life varies depending on use. It is recommended to replace the battery every three years, or sooner, if left powered off for extended periods of time to prevent data loss in the event of a power failure.

Use the Revolution configuration utility ([Section 6.0 on page 43](#)) or EDP commands ([Section 7.0 on page 44](#)) to store a copy of the 680 configuration on a PC before attempting battery replacement. The 680 configuration can be restored from the PC if data is lost.



WARNING

Risk of explosion if battery is replaced with an incorrect type. Dispose of used batteries according to federal, state and local regulations.

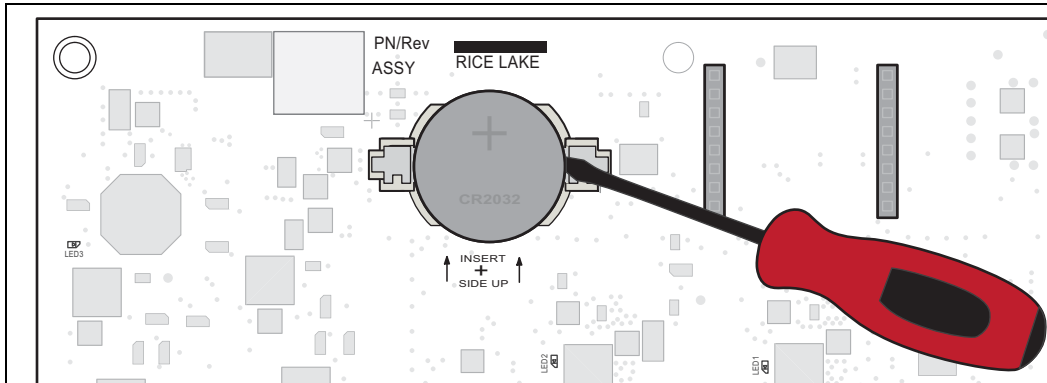

Figure 10-1. Non-Conductive Screw Driver Placement

To replace the battery, use the following procedure:

1. Disconnect power to the indicator.
2. Remove backplate as described in [Section 2.3 on page 5](#).
3. Place the tip of a non-conductive flat head screw driver between negative contact and battery.
4. Twist screw driver to release battery from holder.
5. Press new replacement battery straight into the battery holder with the positive side up. See [Section 2.9 on page 12](#) for replacement battery details.

10.5 Board Replacement

To replace a 680 board, use the following procedure:

1. Disconnect power to the indicator.
2. Remove backplate as described in [Section 2.3 on page 5](#).
3. Label connections for re-installation to board.
4. Disconnect all connections from the board.
5. Remove the four corner screws securing the board, then lift the board from the enclosure.
6. Place new replacement board in place and secure with previously removed screws. See [Section 2.9 on page 12](#) for replacement board details.
7. Reconnect all connections to the board.

IMPORTANT

Always verify indicator has been returned back to a safe state with the proper installation of all connections and a complete functions test before reinstalling the backplate and returning the indicator back to service.

11.0 Appendix

11.1 Error Messages

The 680 indicator provides a number of error messages. When an error occurs, the message is displayed on the indicator.

11.1.1 Displayed Error Messages

The 680 provides a number of front panel error messages to assist in problem diagnosis. [Table 11-1](#) lists these messages and their meanings.

Error Message	Description
-----	Overflow error – Weight value too large to be displayed
nnnnnnnn	Gross > overload limit – Gross value exceeds overload limit; Check configuration or signal input level; Overload can be caused by input signal > 45 mV or common mode voltage > 950 mV
uuuuuuuu	Gross < underload limit – Gross value exceeds underload limit
ERRR IN MOTION NOT ALLOWED	Scrolls across display when attempting to perform a tare while weight is in motion, if in motion tares are not allowed
NEGATIVE TARE NOT ALLOWED	Scrolls across display when attempting to perform a negative tare, if a negative tare is not allowed
KEYED TARE NOT ALLOWED	Scrolls across display when attempting to perform a keyed tare, if a keyed tare is not allowed
TARE LARGER THAN CAPACITY NOT ALLOWED	Scrolls across display when attempting to perform a tare larger than capacity, if it is not allowed
TARE ALREADY IN SYSTEM	Scrolls across display when attempting to perform a tare if a tare is already in the system, if tare is not configured to replace or remove
INITIAL ZERO FAILED	Scrolls across display when an attempt to perform an initial zero fails, only possible at startup
PLEASE WAIT	Scrolls across display when calibrating
ALARM	Displays when a configured setpoint's ALARM action occurs

Table 11-1. 680 Error Messages

11.2 ZZ EDP Command

The ZZ EDP command can be used to remotely query which annunciators are currently displayed on the indicator front panel. The ZZ command returns a decimal number representing the LED annunciators currently lit (see [Table 11-2](#)).

Example: If the annunciator status value returned on the ZZ command is 148, the gross, standstill and lb annunciators are lit. The number 145 represents the sum of the values for the gross mode annunciator (128), the tare entered annunciator (16) and the standstill annunciator (4).

Decimal Value	Annunciator
1	Net
2	Center of zero
4	Standstill
8	Keyed tare entered
16	Tare entered
32	kg/secondary units
64	lb/primary units
128	Gross

Table 11-2. Status Codes Returned on the ZZ Command

11.3 Continuous Data (Stream) Output Formats

When the trigger setting for a port is set to STRIND or STRLFT, data is continuously streamed from the appropriate port in one of the four fixed format options or a custom format option.

Fixed Format Options:

- Rice Lake Weighing Systems ([Section 11.3.1](#))
- Cardinal ([Section 11.3.2](#))
- Avery Weigh-Tronix ([Section 11.3.3 on page 64](#))
- Mettler Toledo ([Section 11.3.4 on page 64](#))

11.3.1 Rice Lake Weighing Systems Stream Format (rLW5)

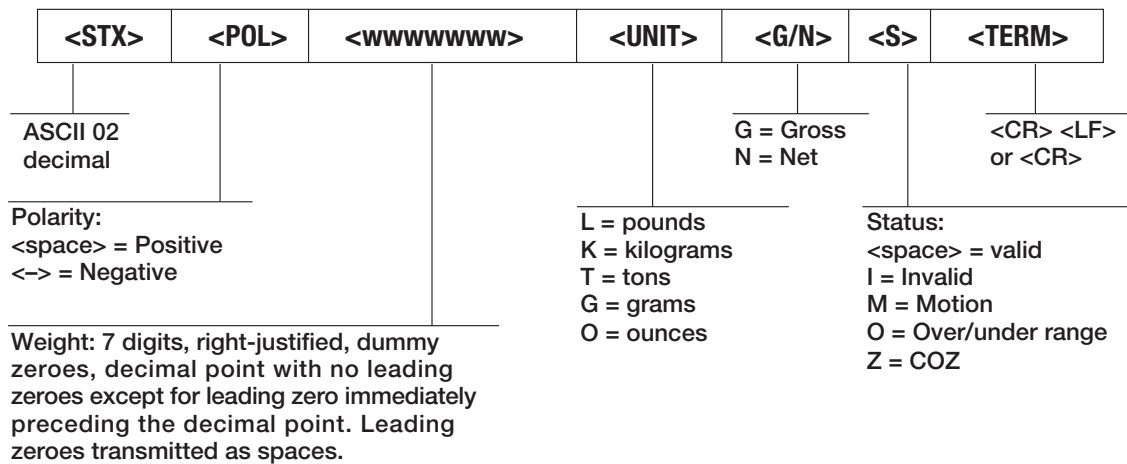

Figure 11-1. Rice Lake Weighing Systems Stream Data Format

11.3.2 Cardinal Stream Format (CR-dnRL)

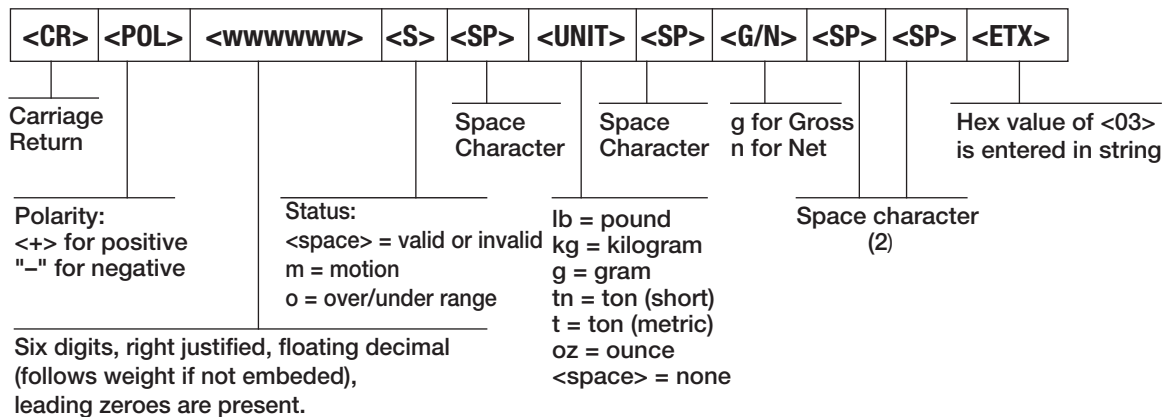

Figure 11-2. Cardinal Stream Data Format

11.3.3 Avery Weigh-Tronix Stream Format (αβγδϵζ)

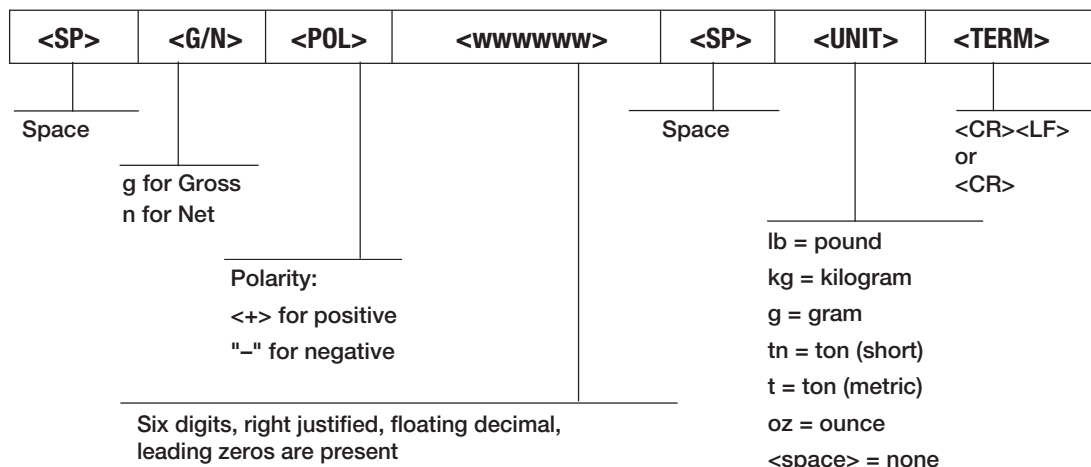

Figure 11-3. Avery Weigh-Tronix Stream Data Format

11.3.4 Mettler Toledo Stream Format (ηθικλμ)

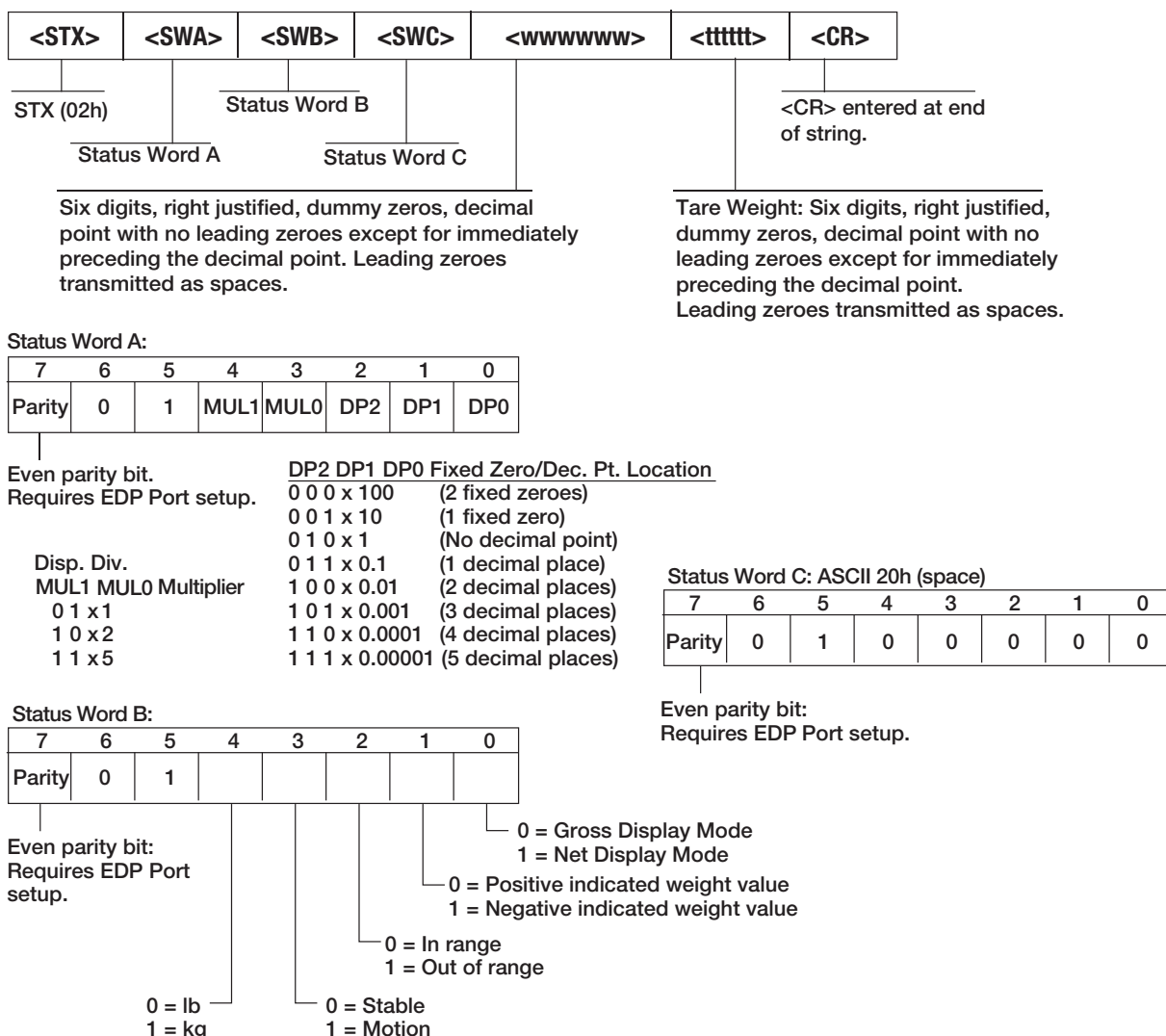

Figure 11-4. Mettler Toledo Stream Data Format

11.4 Local/Remote Operation

For systems which require two locations, local/remote support provides function equivalent to a Legal for Trade remote display with keypad. Scale data from the local indicator is also displayed at the remote unit.

To configure for local/remote operation, set the INPUT parameter in the COMM menu to the REMOTE option for the desired port. Once the local unit scale has been configured, use serial commands or Revolution to set the serial parameters for local/remote operation.

11.5 Audit Trail Support

Audit trail support provides tracking information for configuration and calibration events. To prevent potential misuse, all configuration and calibration changes are counted as change events.

Audit trail information can be printed from Revolution or by sending the DUMPAUDIT serial command. Revolution can be used to display audit trail information. The audit trail display includes the legally relevant (LR) version number (firmware version for the code which provides audit trail information), a calibration count and, if REGULAT=NTEP or Canada, a configuration count. The exact format of the information depends on the regulatory agency specified for the REGULA (Program menu) parameter.

See [Section 3.4.9 on page 18](#) to view the Audit Trail counter.

For NTEP and Measurement Canada modes, there are two numbers displayed: configuration and calibration. The configuration number tracks changes to the legally relevant configuration parameter changes. The calibration number tracks changes to the scale calibration.

In OIML mode, the only number displayed is audit trail. The audit trail number is incremental for legally relevant configuration parameter changes and all calibration changes. The last date the scale was calibrated is also displayed.

11.6 Conversion Factors for Secondary Units

The 680 has the capability to mathematically convert a weight into many different types of units and instantly display those results with a press of the Unit key.

Secondary units can be specified on the Format menu using the **SECNDR** parameter.



Note

Multipliers are preconfigured within the indicator.

Ensure the secondary decimal point position is set appropriately for the scale capacity in the secondary units.

11.7 Digital Filtering

Digital filtering is used to create a stable scale reading in challenging environments. The 680 allows selection of **Digital Rolling Average Filtering** ([Section 11.7.1](#)), **Adaptive Filtering** ([Section 11.7.2 on page 66](#)), **Damping** ([Section 11.7.3 on page 67](#)) or **None** (RAW) for no filtering. See [Section 4.4.1 on page 24](#) for configuration menu layout and the location of FLTRCHN parameter.

The scale's sample rate effects all types of filtering. The A/D sample rate is selected by the SMPRAT scale parameter. The A/D sample rate is the number of weight readings the indicator takes per second (SMPRAT). This can be 6.25, 7.5, 12.5, 15, 25, 30, 50, 60 or 120 hertz (readings per second). Set the A/D sample rate to the lowest setting required for the application. Lower settings result in better stability.

11.7.1 Digital Rolling Average Filter (AVGONLY)

The digital rolling average filter uses mathematical averaging with three stages. These configurable stages control the effect of a single A/D reading on the displayed weight. When an A/D reading outside of a predetermined band is encountered, the digital rolling average filter is overridden and the display jumps directly to the new value.

Digital Filter Stages (DGFLTR1-3)

The filter stages can each be set to a value of 1–256. The value assigned to each stage sets the number of readings received from the preceding filter stage before averaging. Setting the filter stages to 1 effectively disables the rolling filter.

A rolling average is passed to successive filtering stages for an overall filtering effect which is effectively a weighted average of the product of the values assigned to the filter stages (**DGFLTR1 x DGFLTR2 x DGFLTR3**) within a time frame corresponding to the sum of the values (**DGFLTR1 + DGFLTR2 + DGFLTR3**).

Digital Filter Sensitivity (DFSENS) and Threshold (DFTHRH)

The rolling averaging filter can be used by itself to eliminate vibration effects, but heavy filtering also increases settling time. The **DFSENS** and **DFTHRH** parameters can be used to temporarily override filter averaging and improve settling time.

- **DFSENS** specifies the number of consecutive A/D readings which must fall outside the filter threshold (**DFTHRH**) before filtering is suspended
- **DFTHRH** sets a threshold value, in display divisions; When the specified number of consecutive A/D readings (**DFSENS**) fall outside of this threshold, filtering is suspended; Set **DFTHRH** to **NONE** to turn off the filter override

Digital Rolling Average Filter Procedure

1. In setup mode, set the rolling filter stage parameters (**DGFLTR1-3**) to 1.
2. Set **DFTHRH** to **NONE**.
3. Return to weigh mode.
4. Remove all weight from scale, then watch the indicator to determine the magnitude of vibration effects on the scale.
5. Record weight below which all but a few readings fall. This value is used to calculate the **DFTHRH** parameter in [step 8](#).
Example – if a heavy-capacity scale (10000 x 5 lb) produces vibration-related readings of up to 50 lb, with occasional spikes up to 75 lb, record 50 as the threshold weight value.
6. Place the indicator in setup mode and set the filter stage parameters (**DGFLTR1-3**) to eliminate the vibration effects on the scale (leave **DFTHRH** set to **NONE**).
7. Find the lowest effect value for the **DGFLTR1-3** parameters.

If needed, the digital filter cutout sensitivity (**DFSENS**) and the digital filter cutout threshold (**DFTHRH**) can be used to reset the digital rolling average filter so the response to a rate change is faster.

8. Calculate the **DFTHRH** parameter value by converting the weight value recorded in [step 5](#) to display divisions (**Threshold_Weight_Value / Display_Divisions**).
*In the example in [step 5](#), with a threshold value of 50, and a display divisions value of 5, set the **DFTHRH** parameter to 10 display divisions.*
9. Set the **DFSENS** parameter high enough to ignore transient peaks. Longer transients (typically caused by lower vibration frequencies) causes more consecutive out-of-band readings; set the **DFSENS** parameter higher to counter low frequency transients.

11.7.2 Adaptive Filter (ADPONLY)

The adaptive filter has two settings, sensitivity (**ADSENS**) and threshold (**ADTHRH**). It maintains a running average of the A/D readings when the weight change remains less than the defined threshold value. The filter automatically applies less value to each successive A/D reading the longer the weight change is less than the threshold value. The amount of value given to the most recent A/D reading is determined by the sensitivity setting.

Adaptive Filter Sensitivity (ADSENS)

Adaptive filter sensitivity (**ADSENS**) can be set to **HEAVY**, **MEDIUM** or **LIGHT**. A **HEAVY** setting results in an output which is more stable to weight changes than the **LIGHT** setting. A **HEAVY** setting also results in small changes in weight data (a few grads) on the scale base to not be seen as quickly as with the **LIGHT** setting.

If the difference in typical subsequent weight values on the scale are only a few display divisions, use a **LIGHT** setting. On a truck scale where the changes in subsequent weight values are 100s of display divisions, a **HEAVY** setting is more appropriate.

Adaptive Filter Threshold (ADTHR)

Set the adaptive filtering threshold (**ADTHR**) for the amount of observed instability in the system. This parameter can be set in the range of 0–2000 and is entered as a weight value. When a new sampled weight value is acquired, the adaptive filter compares the new value to the previous (filtered) output value.

If the difference between the new value and the previous output value is greater than the **ADTHR** parameter the adaptive filter is reset to the new weight value.

If the difference between the new value and the previous output value is less than the **ADTHR** parameter, the two values are averaged together using a weighted average. The weighted average is based on the amount of time the system has been stable, and selected **ADSENS** sensitivity.

With the adaptive filter threshold set at zero, determine the amount of instability present. Enter this amount of weight instability to set the threshold of the adaptive filter. The adaptive filter is set to **OFF** the **ADTHR** parameter is set to zero.

11.7.3 Damping Filter (DMPONLY)

The damping filter is a simple filter which adjusts the amount of time it takes for a change in weight to be processed through the scale. The **DAMPVAL** parameter is a time interval specified in tenths of a second (10 = 1 second). This damping value is used to determine the amount of time it takes for the scale to reach its final weight output. When **DAMPVAL** is set to ten, a transition from 0 lb to 500 lb on the scale takes one second. The closer the weight gets to its final amount, the slower the weight changes on the display.

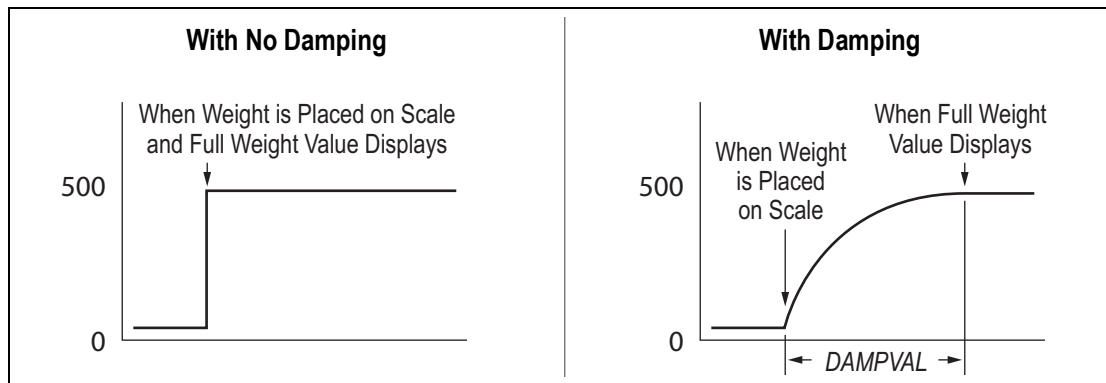

Figure 11-5. 500 lb Displayed Weight Progression

11.8 Regulatory Mode Functions

Regulatory Parameter	Weight On Scale	Tare In System	Front Panel Key Tare	Front Panel Key Zero
NTEP	Zero	No	"0000000"	Zero
		Yes	Clear tare	Zero
	Negative	No	No action	Zero
		Yes	Clear tare	Zero
	Positive	No	Tare	Zero
		Yes	Tare	Zero
Canada	Zero	No	"0000000"	Zero
		Yes	Clear tare	Clear tare
	Negative	No	No action	Zero
		Yes	Clear tare	Clear tare
	Positive	No	Tare	Zero
		Yes	No action	Clear tare
OIML	Zero	No	"0000000"	Zero
		Yes	Clear tare	Zero and Clear tare
	Negative	No	No action	Zero
		Yes	Clear tare	Zero and Clear tare
	Positive	No	"0000000"	Zero
		Yes	Tare	Zero and Clear Tare
None	Zero	No	"0000000"	Zero
		Yes	Clear tare	Clear tare
	Negative	No	No action	Zero
		Yes	Clear tare	Clear tare
	Positive	No	Tare	Zero
		Yes	Clear tare	Clear tare

Table 11-3. Tare and Zero Key Functions for REGULA Parameter Settings

11.9 ASCII Character Chart

Use the decimal values for ASCII characters listed in [Table 11-4](#) when specifying print format strings on the 680 PFORMT menu. The actual character printed depends on the character mapping used by the output device.

The 680 can send or receive ASCII character values (decimal 0–255), but the indicator display is limited to numbers, uppercase, unaccented letters and a few special characters. See [Section 11.10](#) for information about the 680 LED display.

Control	ASCII	Dec	Hex	ASCII	Dec	Hex	ASCII	Dec	Hex	ASCII	Dec	Hex
Ctrl-@	NUL	00	00	space	32	20	@	64	40	`	96	60
Ctrl-A	SOH	01	01	!	33	21	A	65	41	a	97	61
Ctrl-B	STX	02	02	"	34	22	B	66	42	b	98	62
Ctrl-C	ETX	03	03	#	35	23	C	67	43	c	99	63
Ctrl-D	EOT	04	04	\$	36	24	D	68	44	d	100	64
Ctrl-E	ENQ	05	05	%	37	25	E	69	45	e	101	65
Ctrl-F	ACK	06	06	&	38	26	F	70	46	f	102	66
Ctrl-G	BEL	07	07	'	39	27	G	71	47	g	103	67
Ctrl-H	BS	08	08	(40	28	H	72	48	h	104	68
Ctrl-I	HT	09	09)	41	29	I	73	49	i	105	69
Ctrl-J	LF	10	0A	*	42	2A	J	74	4A	j	106	6A
Ctrl-K	VT	11	0B	+	43	2B	K	75	4B	k	107	6B
Ctrl-L	FF	12	0C	,	44	2C	L	76	4C	l	108	6C
Ctrl-M	CR	13	0D	-	45	2D	M	77	4D	m	109	6D
Ctrl-N	SO	14	0E	.	46	2E	N	78	4E	n	110	6E
Ctrl-O	SI	15	0F	/	47	2F	O	79	4F	o	111	6F
Ctrl-P	DLE	16	10	0	48	30	P	80	50	p	112	70
Ctrl-Q	DC1	17	11	1	49	31	Q	81	51	q	113	71
Ctrl-R	DC2	18	12	2	50	32	R	82	52	r	114	72
Ctrl-S	DC3	19	13	3	51	33	S	83	53	s	115	73
Ctrl-T	DC4	20	14	4	52	34	T	84	54	t	116	74
Ctrl-U	NAK	21	15	5	53	35	U	85	55	u	117	75
Ctrl-V	SYN	22	16	6	54	36	V	86	56	v	118	76
Ctrl-W	ETB	23	17	7	55	37	W	87	57	w	119	77
Ctrl-X	CAN	24	18	8	56	38	X	88	58	x	120	78
Ctrl-Y	EM	25	19	9	57	39	Y	89	59	y	121	79
Ctrl-Z	SUB	26	1A	:	58	3A	Z	90	5A	z	122	7A
Ctrl-[ESC	27	1B	;	59	3B	[91	5B	{	123	7B
Ctrl-\	FS	28	1C	<	60	3C	\	92	5C		124	7C
Ctrl-]	GS	29	1D	=	61	3D]	93	5D	}	125	7D
Ctrl-^	RS	30	1E	>	62	3E	^	94	5E	~	126	7E
Ctrl-_	US	31	1F	?	63	3F	_	95	5F	DEL	127	7F

Table 11-4. ASCII Character Chart

11.10 Front Panel Display Characters

Refer to [Figure 11-6](#) for the seven-segment LED character set used on the 680 front panel display for alphanumeric characters.

	-	9	E	Q
	.	:	F	R
	/	;	G	S
	0	<	H	T
%	1	=	I	U
&	2	>	J	V
,	3	?	K	W
(4	@	L	X
)	5	A	M	Y
*	6	B	N	Z
+	7	C	O	[
,	8	D	P	\

Figure 11-6. 680 Display Characters

12.0 Compliance



EU DECLARATION OF CONFORMITY

EU-KONFORMITÄTSERKLÄRUNG
DÉCLARATION UE DE CONFORMITÉ

Rice Lake Weighing Systems
230 West Coleman Street
Rice Lake, Wisconsin 54868
United States of America

RICE LAKE
WEIGHING SYSTEMS

Type/Typ/Type: 680 indicator series

English We declare under our sole responsibility that the products to which this declaration refers to, is in conformity with the following standard(s) or other regulations document(s).

Deutsch Wir erklären unter unserer alleinigen Verantwortung, dass die Produkte auf die sich diese Erklärung bezieht, den folgenden Normen und Regulierungsbestimmungen entsprechen.

Francais Nous déclarons sous notre responsabilité que les produits auxquels se rapporte la présente déclaration, sont conformes à la/aux norme/s suivante ou au/aux document/s normatif/s suivant/s.

EU Directive	Certificates	Standards Used / Notified Body Involvement
2014/30/EU EMC	-	EN 61326-1:2013
2014/35/EU LVD	-	IEC 61010-1:2010+A1:2016
2011/65/EU RoHS	-	EN 50581:2012

Signature:

Richard Shipman

Place:

Rice Lake, WI USA

Type Name:

Richard Shipman

Date:

July 22, 2019

Title:

Quality Manager

13.0 Specifications

Power

Line voltage: 120-240 VAC
Frequency: 50-60 Hz

Power consumption:

~2 W (AC) with one 350 Ω load cell, 15 W max

Excitation Voltage

10 VDC bi-polar (± 5 VDC), 8 x 350 Ω or 16 x 700 Ω load cells

Analog Output (Optional)

Type Voltage or current output, 16-bit resolution
Voltage output 0-5 VDC, 0-10 VDC, ± 5 VDC, ± 10 VDC
Voltage load resistance 1 K Ω minimum
Current output 0-20 mA, 0-24 mA, 4-20 mA
Current loop resistance 1,000 Ω maximum

Analog Signal Input Range

-0.5 mV/V to +7 mV/V

Analog Signal Sensitivity

Recommended: 1 μ V/graduation

A/D Sample Rate

6.25-120 Hz, software selectable

Resolution

Internal: 8,000,000 counts
Display: 1,000,000

System Linearity / PI Rating

Within 0.01% full scale

Digital I/O

Four configurable I/O (5 V logic)

Communication Ports

Two RS-232 (three-wire)
RS-485/422 (five-wire)
Micro USB (device)
Ethernet (10/100)

Status Annunciators

Eight LED annunciators

Display

Seven 0.8" (20 mm) tall, seven-segment digits

Keys / Buttons

Flat membrane panel, tactile feel (18 buttons plus power)

Temperature Range

Legal: 14–104°F (-10–40°C)
Industrial: 14–122°F (-10–50°C)

Environmental

Intended environment: Pollution Degree 3
Wet location: Rated for washdown environments
Recommended use: Indoor

Dimensions (W x H x D)

11.58 x 8.57 x 4.05" (29.41 x 21.77 x 10.29 cm)

Weight

6.25 lb (2.84 kg)

Rating / Material

Rating: IP69K
Material: AISI 304 Stainless Steel

Warranty

Two-year limited warranty

EMC Immunity

10 V/m

Certifications and Approvals



NTEP
CoC Number 19-021
Accuracy Class: III/IIIL; n_{max} : 10 000



UL
File Number: E505539



OIML
Approval Pending

Measurement Canada

Approval AM-6121C
Accuracy Class: III/IIILD; n_{max} : 10 000

The 680 complies with Part 15 of the FCC Rules. Operation is subject to the following conditions:

- This device may not cause harmful interference.
- This device must accept any interference received, including interference that may cause undesired operation.





© Rice Lake Weighing Systems Specifications subject to change without notice.
Rice Lake Weighing Systems is an ISO 9001 registered company.

230 W. Coleman St. • Rice Lake, WI 54868 • USA
U.S. 800-472-6703 • Canada/Mexico 800-321-6703 • International 715-234-9171 • Europe +31 (0)26 472 1319