

Elite REEL SYSTEMS

HV-10 DELUXE INGROUND REEL SYSTEM

For solar covers up to 20' x 45'

PREPARATIONS

PLACEMENT ON DIFFERENT SHAPE POOLS:

Before assembling the reel, determine its best location on the pool. The end of the pool is most often the preferred location. On some pools, a mid-point location may be required to avoid dragging the blanket over the deck, or to avoid diving boards and ladders. Blanket may be folded in to avoid using a larger reel.

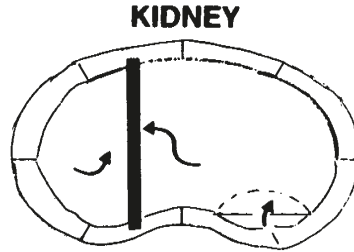

Place reel at widest point. Fold blanket in if required.

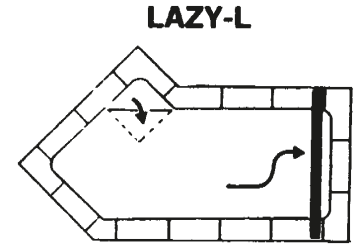

Place reel at square end and fold 'L' over.

HELPFUL HINTS

1. Always place white protective cover over blanket and secure.
2. Make sure cover is properly trimmed away from pool's edge.
3. If tubing is sagging refer to "Assembly of Tubing".
4. If your pool is kidney shaped, you may only need 3 straps to attach to tubing. Refer to "Preferred Reel Placement".
5. If tubing discolors (turns grayish black), use aluminum metal cleaner. We recommend "FLITZ" which is available at local hardware stores. The discoloring will not effect the performance of your reel.

OVAL WITH EXTENSION

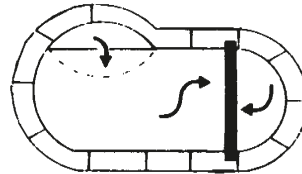

Options: Fold extension in, or use wider reel at widest point.

RECTANGULAR

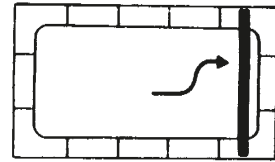

Place reel at either end.

HV-10 PARTS LIST

<u>Part Description</u>	<u>Part #</u>	<u>Qty.</u>	<u>Part Description</u>	<u>Part #</u>	<u>Qty.</u>
1) Knob Screw	3057	2	9) End Cap Screw (3/4")	3055	2
2) Handcrank Knob	2005	2	10) Strap Buckle (1")	2009	8
3) Handle Bearing	2004	2	11) Cover Plate (set)	2007	8
4) Handcrank Screw	3054	2	12) Velcro Hook (1")	5002	8
5) Handcrank (w/knob)	2015	2	13) 6' Strap	5001	8
6) HV-10 Base	2016	2	14) Tube Neoprene Fastener	3056	8
7) Bearing (L)	2006	2	15) 8'0" Alum. Tube (outer)	3002	1
8) End Cap	2002	2	16) 8'0" Alum. Tube (Inner)	3001	2

TOOLS REQUIRED

- 1) Power Drill 2) Metal Drill Bits (1/2", 5/32") 3) Hex Socket Wrench and 7/16" Socket. 4) Phillips Screwdriver

***OPTIONAL CASTERS ARE AVAILABLE FOR PORTABILITY.(SEE SECTION IX: ITEM #7)**

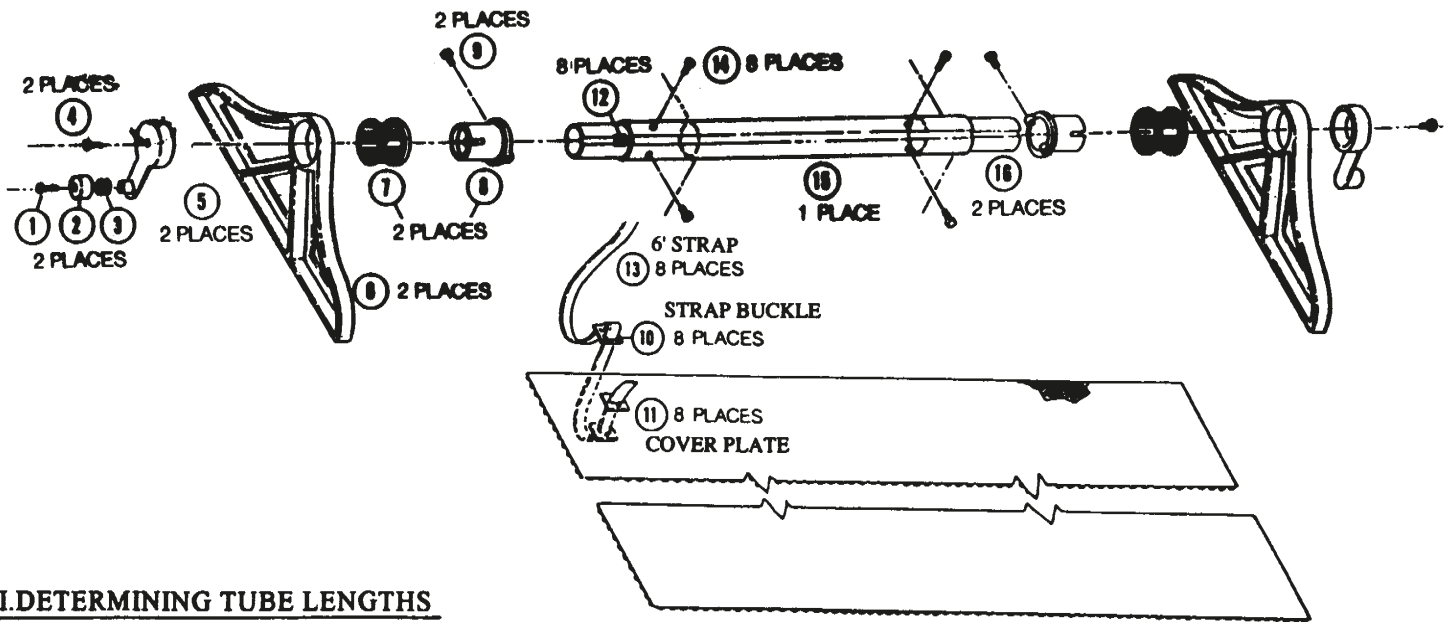

I. DETERMINING TUBE LENGTHS

(Refer to Table #1, and Diagram #1)

TABLE #1

POOL WIDTH (FEET)	TOTAL TUBE LENGTH (FEET)	LENGTH A (FEET)
14	16'	4
16	18'	5
18	20'	6
20	22'	7

1. Place sections #1 & #3 into section #2. Slide sections #1 & #3 out to the desired TOTAL tube length. (Usually the total tube length is the pool width + 2'0") Refer to Table #1 and Diagram #1.

II. ASSEMBLY OF TUBING

(Refer to Diagram #2)

1. To fasten tubing, you must **always** use Section #2 for measurements. Measure 3" from the left end of Section #2, and mark on tube. Use power drill and a sharp 1/2" metal drill bit. Using the groove in the center of tube for reference, drill a hole thru section #2 and section #1. Place tube neoprene fastener into the hole. Use a hex socket wrench with 7/16" socket and tighten hex head bolt down completely. (Refer to Step #1/Diagram #2)

2. Rotate tubes 90 degrees, measure 10" from left end of section #2. Drill hole thru section #2 and section #1, place tube neoprene fastener into hole and tighten completely. (Refer to Step #2)

3. Rotate tubes another 90 degrees, measure 3" from left end of section #2. Drill hole thru section #2 and section #1, place tube neoprene fastener into hole and tighten completely. (Refer Step #3)

4. Rotate tubes another 90 degrees, measure 10" from left end of section #2. Repeat directions of Step #2.

5. Now go back to all the tube fasteners and re-tighten.

6. To fasten Section #2 and Section #3 together, take measurements from right end of section #2, then follow steps #1-5.

III. ATTACH END CAP (TO ALUMINUM TUBING)

(Refer to Diagram #3)

1. Place End Cap (Part #2002) on end of section #1. Make sure end cap inserts line up with indentions of tubing. Using the end cap pre-drilled hole as a guide. Use power drill and 5/32" drill bit. Drill hole thru tube and fasten End Cap screw (Part #3005). Tighten screw down. Drill only 1 hole per End Cap. **DO NOT DRILL BOTH HOLES OF THE END CAP.** The 2nd hole is a spare, and is there for your convenience. To fasten End Cap to section #3 repeat previous directions

DIAGRAM #1



DIAGRAM #2

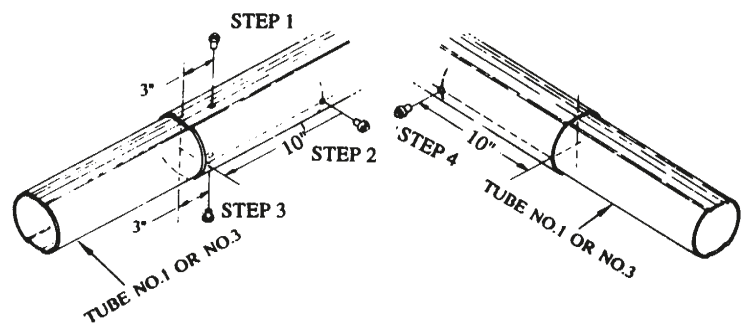
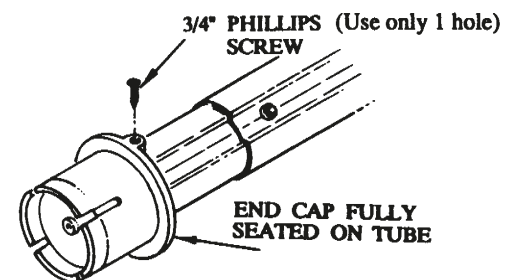

DIAGRAM #3



IV. ATTACH BEARING/BASE/HANDCRANK

(Refer to Diagram #4)

1. Place BASE (Part #2016) onto pool deck.
2. Place bearing over the end cap. Place end cap, and bearing into base opening.
3. Place Handcrank onto end cap. Fasten Handcrank screw (Part #3054) onto handcrank.
4. **For other side of reel**, repeat steps #1-3.
5. To enhance performance, make sure handcranks are exactly in the same position. Example: if handcrank is facing straight down, the other handcrank is also facing straight down.

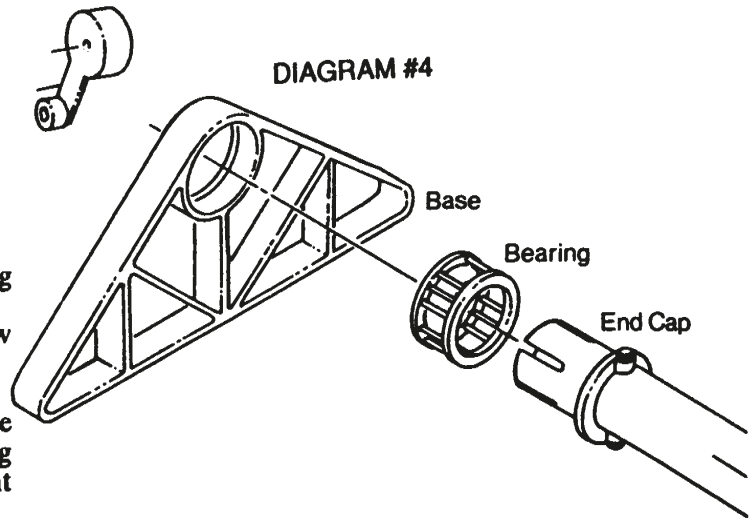

V. CONNECTING THE COVER TO THE REEL

(Refer to Diagram #5)

1. Select a location suitable for pool cover removal, usually on the pool end without steps. Refer to preferred reel placement which is at beginning of instructions. Make sure the pool cover is trimmed properly. The tube should be positioned perpendicular to the center line of the pool as in Diagram #5. **PROPER ALIGNMENT BETWEEN POOL COVER AND THE TUBE IS CRITICAL!** Whether your pool is rectangular or irregular in shape, the straps must be placed and installed so that there is equal pull on all straps at the same time to prevent misalignment of the cover.

DIAGRAM #5

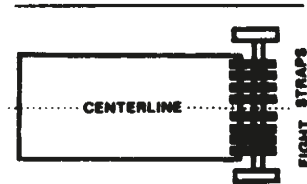

VI. ATTACH COVER PLATES TO BLANKET

(Refer to Diagram #6)

1. Starting at one side of the pool cover, position a set of plates (male and female) with the large center slot at the location of the first strap and at least 2" from any edge of the pool cover.
2. With a sharp instrument, using the female plate as a guide and with the raised ridges facing **DOWNWARD**, punch 3 holes through the plate and cover. The holes must be as wide as the holes in the plate.
3. Place a male plate under the cover directly beneath the female plate.
4. Insert the 2 snaps through the cover and snap together. If the plates do not snap into position with normal force, remove excess cover material.
5. Repeat this operation until all the plates have been installed on the cover.

DIAGRAM #6

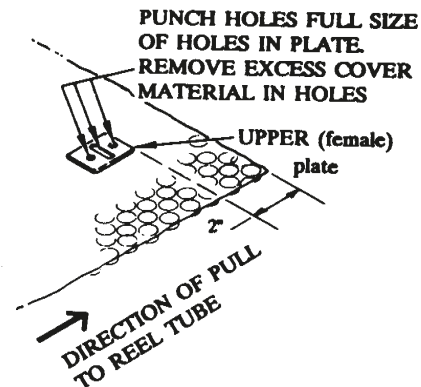

VII. ATTACH STRAP/STRAP BUCKLE

(Refer to Diagram 7A, 7B, 7C)

1. With the ridged crossbar on the strap buckle up, slide the buckle onto the strap from the end opposite the velcro.

DIAGRAM #7A

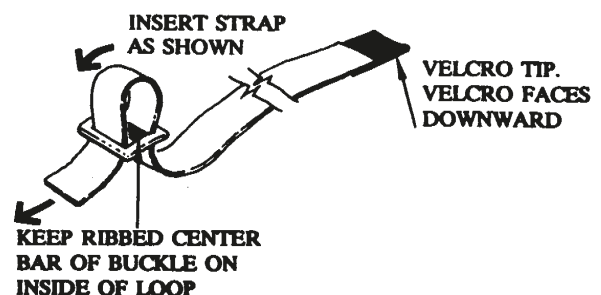

2. Position the buckle at least 24" up from the strap end. Bring the strap underneath the pool cover and up through the center opening in the plate.
3. Thread the strap end back through the buckle.
4. Repeat process for each strap.

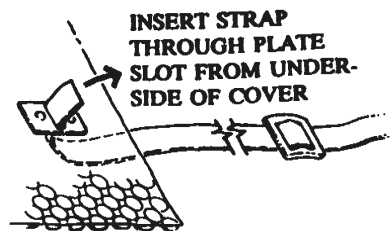

DIAGRAM #7B

VIII. ATTACH VELCRO HOOK TO ALUMINUM TUBE

(Refer to Diagram #8)

1. Place the velcro end of the strap over the tube.
2. Standing behind the tube, pull the strap taut and align as straight as possible between the cover plate and the tube.
3. Remove adhesive backing from the velcro tab and place it firmly into position on top of the tube. Tube must be dry and free from grease or dirt.

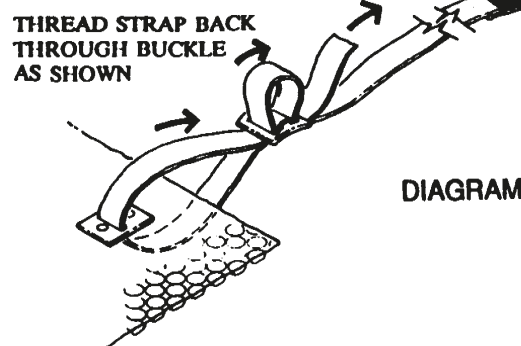

DIAGRAM #7C

4. Repeat procedure for each strap, keeping the velcro adhesive tabs in a line along the top of the tube.

5. Use the buckles to adjust each strap so all provide equal tension on the tube. This is necessary for proper alignment!

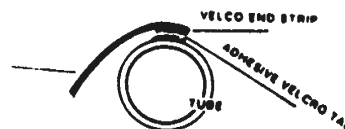

DIAGRAM #8

IX. OPERATING INSTRUCTIONS

(Refer to Diagram #9 & 10)

1. Place reel in a straddling position 2' in from the end of the pool.
2. Turn handwheel slowly. The straps will move the cover away from back edge of pool and fold over itself toward the tubing.
3. Continue turning the handwheel, the cover will continue to fold over itself, eventually going underneath the tube, then up, over and onto the tube.
4. You may have to straighten/unwrinkle the cover as it wraps onto the tube. The smoother the cover wraps onto the tube, the easier the unrolling of the cover when putting cover back onto the pool.
5. Continue rolling cover onto the reel. Keep cover seams straight and avoid cover misalignment.
6. Suggestion: If you move your reel away after cover roll up, mark the position of the bases on your pool deck. This will assure proper roll up the next time you use your reel system.
7. **Optional** Casters are available for your convenience. The (4) Heavy-Duty casters allow your HV-10 reel to become portable. The casters simply flip down for moving the HV-10. When your done moving the reel, flip the 4 casters back up into the HV-10 base for storage. See HV-10 Parts Order Form for prices. (Part #7027)

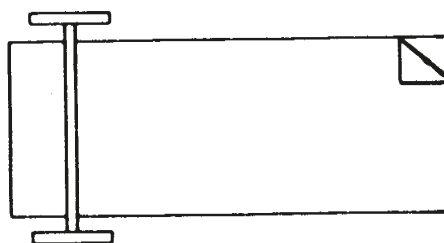

DIAGRAM #9

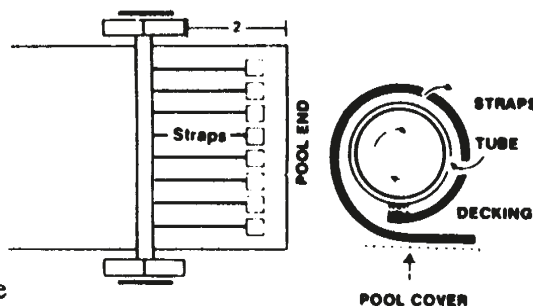

DIAGRAM #10