







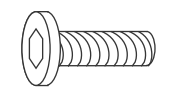

10 DRAWER ROLLING ORGANIZER

ITEM# 5099478-HOBBY LOBBY

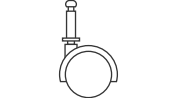
CODE	PARTS	QTY
34ABK	 FRAME	2
34BBK	 CROSSBAR	4
34C	 CROSSBAR SPACER	8
34D	 HEX SCREWS	8
34E	 HEX WRENCH	1
34F	 CASTER	2
34G	 LOCKING CASTER	2
34HBK	 TOP PLATE	1
34I	 DRAWER	10
34JBK	 KNOB	10
34K	 KNOB SCREW	10

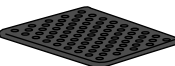
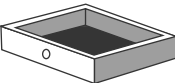
STEP 1

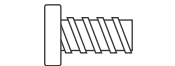
- Make sure Drawer Rails on Frames (A) are facing each other. Snap Locking Casters (G) into same end of each Frame.
- Snap non-locking Casters (F) into Frames.

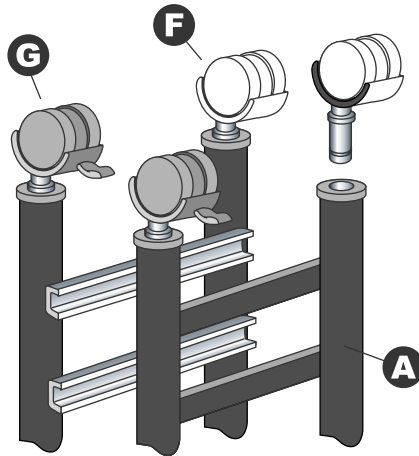

STEP 2

- Attach 4 Crossbars (B) to 1 Frame (A) using the 4 Crossbar Spacers (C) and 4 Hex Screws (D). Make sure curved side of Spacers faces Frame. Do not fully tighten screws.
- Attach 2nd Frame to 4 Crossbars following instructions as above.
- Fully tighten all 8 screws.

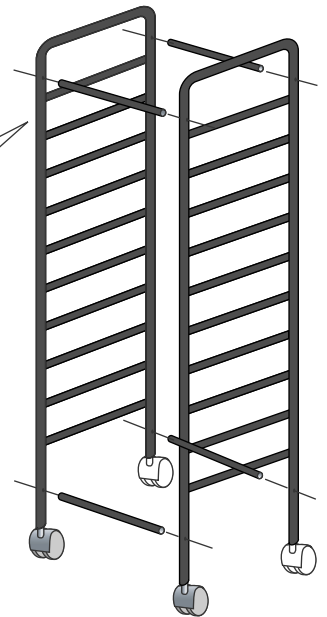
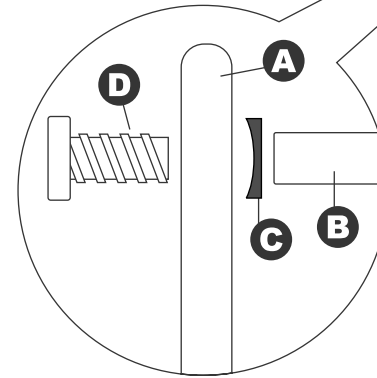

STEP 3

- Snap on Top Plate (H).

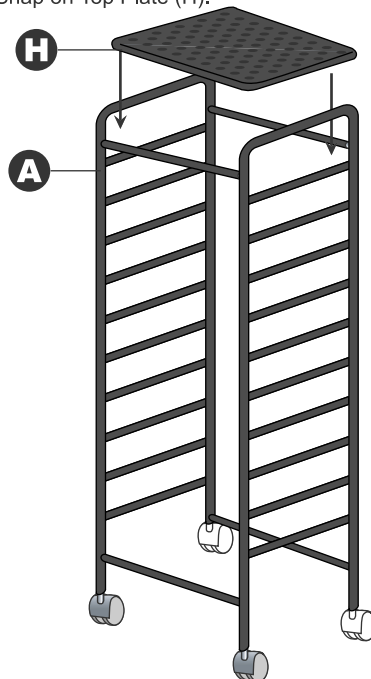

STEP 4

- Attach 10 Knobs (J) to 10 Drawers (I) with 10 Knob Screws (K).

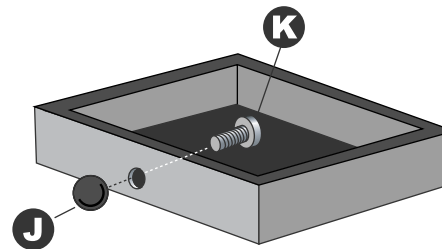

STEP 5

- Insert Drawers into rails.

