

**LET'S
GO**



Colugo Compact Stroller
Instructions



WARNING: FALL AND SUFFOCATION HAZARD

IMPORTANT: RETAIN FOR FUTURE REFERENCE.

Failure to follow these warnings and the assembly instructions could result in serious injury or death.

WARNINGS

- Never leave child unattended. Always keep child in view while in the stroller.

Avoid serious injury from falling or sliding out. Child may slip into leg openings and strangle. Never use in reclined carriage position unless using infant insert. Always use restraint system. This seat unit is not suitable for children under 6 months without using infant insert.

- **TO PREVENT HAZARDOUS, UNSTABLE CONDITION**, do not place more than 10 lbs in the storage basket.

- **TO AVOID INJURY TO YOUR CHILD: DO NOT USE STORAGE BASKET AS A CHILD CARRIER.**

- Never place purse, shopping bags, parcels or accessory items on the handle or canopy.

- This stroller can be used with children up to 55 lbs.

- **CUP HOLDER** - max .7 lb.

- **AVOID FINGER ENTRAPMENT:** Use care when folding and unfolding the stroller. Be certain the stroller is fully opened and latched before allowing child near the stroller.

- **ALWAYS ENSURE** that all parts of the child's body are clear of any moving parts. Do not carry additional children, parcels, goods or accessories in or on this product except as recommended in the manufacturers instructions.

- The brake must be locked while taking the child out of stroller and when parked.

- Keep stroller away from open fire and other sources of strong heat.

- Do not make any alterations or modifications to the stroller with products not supplied by the manufacturer as this may cause instability or structural damage.

- Do not use on stairs or escalators.

- When folded, make sure the stroller is stored in a place where it does not risk falling on a child.

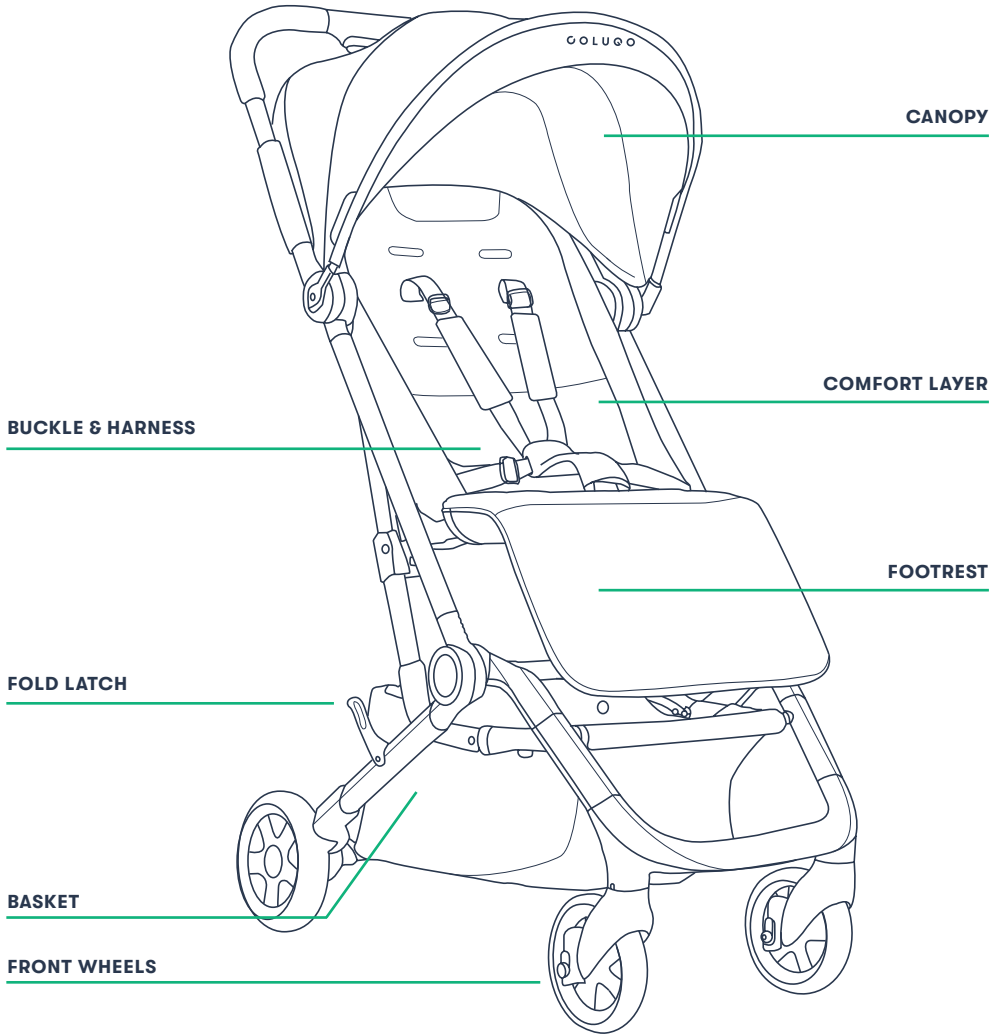

FOLD BUTTONS

REAR CANOPY TOGGLE

BACKSTAY

BACKREST ADJUSTMENT

CARRY STRAP & POCKET

REAR WHEELS

BRAKE

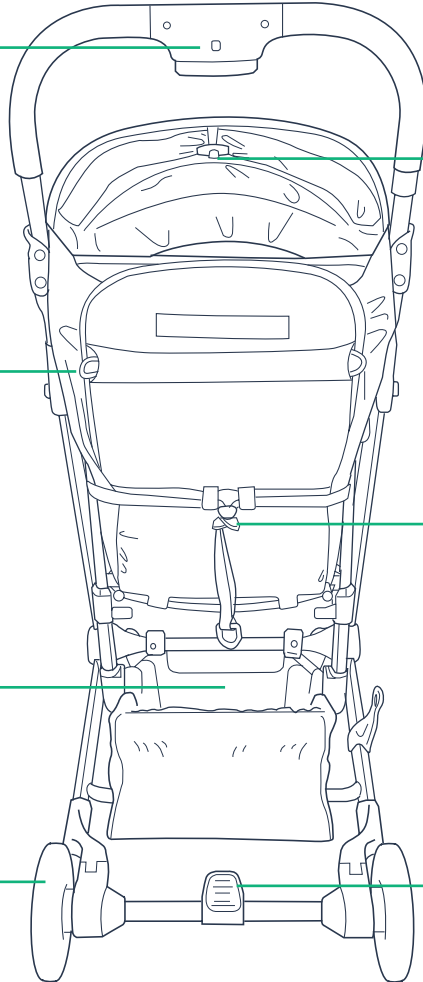

6 OPENING YOUR STROLLER

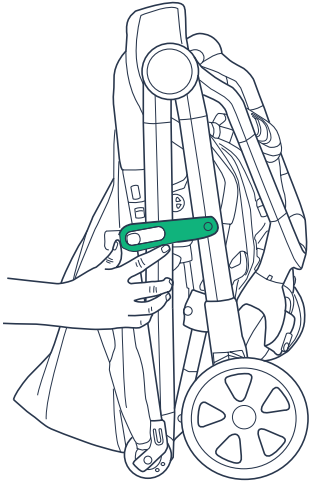

STEP 1

Release the fold latch by pulling out with one hand.

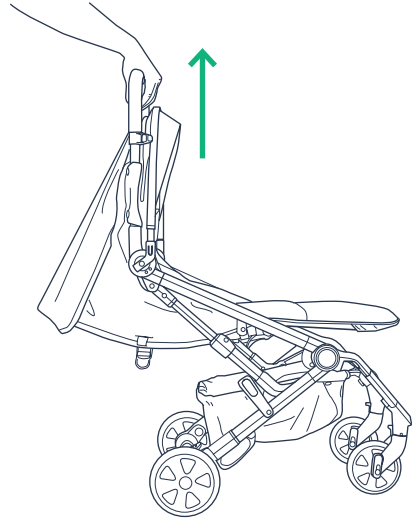

STEP 2

Grip the handle and lift up to unfold the stroller.

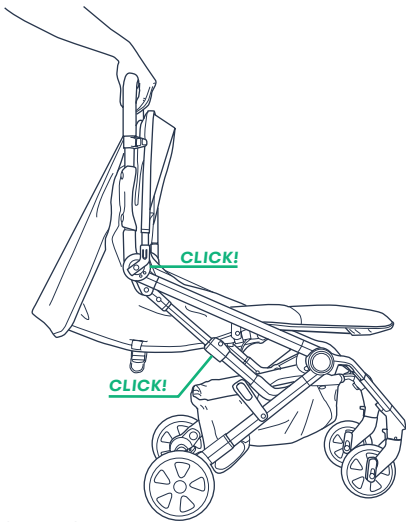

STEP 3

You will hear 2 'clicks' to indicate the stroller is in its fully open position.

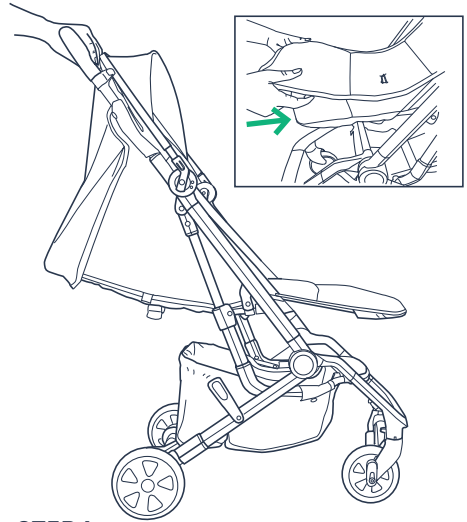

STEP 4

If the seat is in the reclined position, attach the rear canopy velcro. Slide the comfort layer onto the seat.

STEP 1

Ensure the front swivel locks are released before folding.

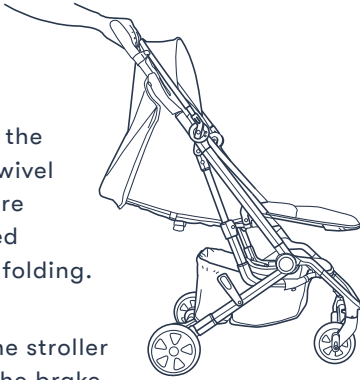

STEP 2

Lock the stroller using the brake.

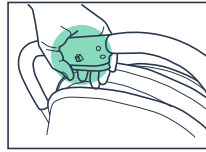

STEP 3

Grip the handle. Press the small button, then squeeze the large button, to begin the fold.

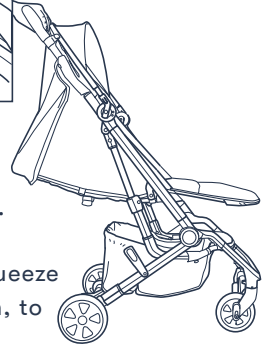

STEP 4

Push the handle down and forward, bringing the frame together.

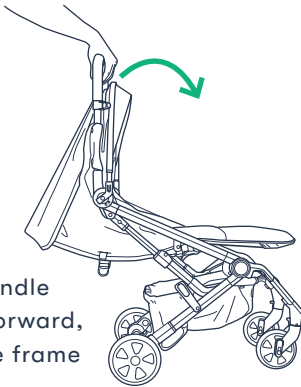

STEP 5

Ensure the fold latch is engaged. You will hear a 'click.'

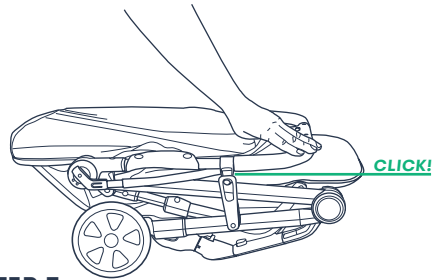

STEP 6

For the most compact fold, use the backstay. Ensure the rear elastic bands are fastened to the bottom buttons.

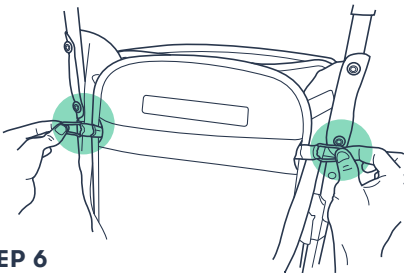

STEP 7

If carrying, use the carry strap.

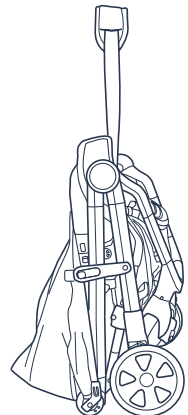

USING THE SWIVEL LOCK

To lock the wheels in a straight position, press the swivel lock down into the notch. To enable the wheels' full range of motion, pull back on the swivel lock. The stroller cannot be folded with the wheels in a straight position.

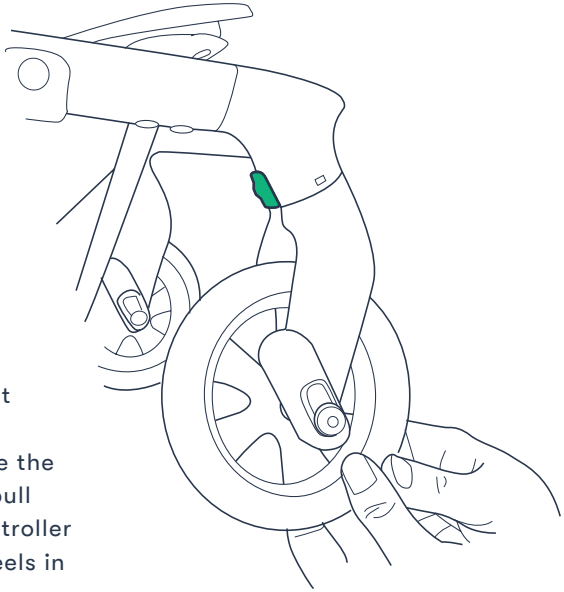
**APPLYING THE BRAKE**

To lock the brake, push the brake pedal down. To unlock the brake, push the brake pedal up.

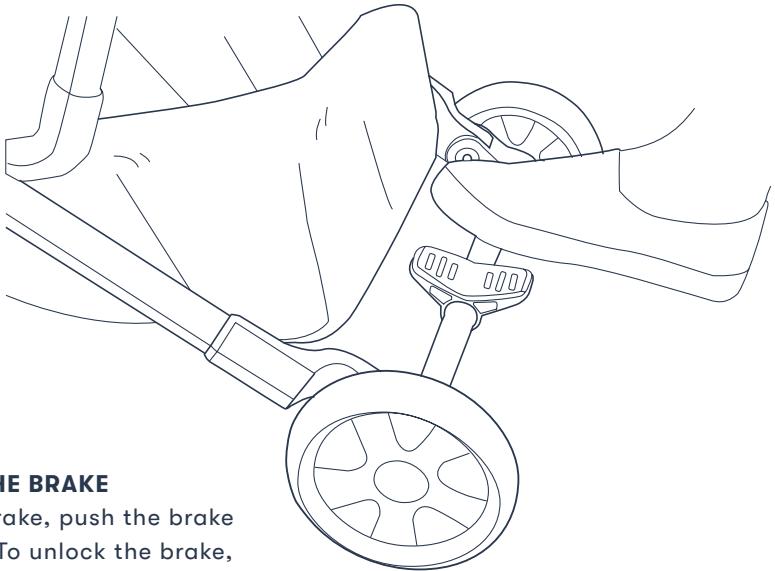

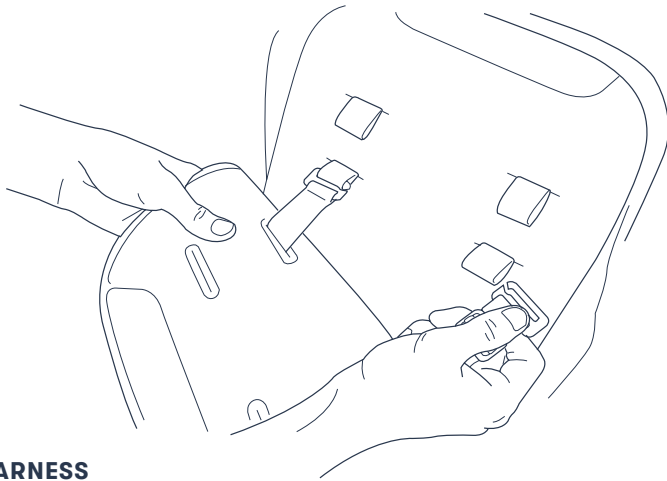
**USING THE HARNESS**

To adjust the shoulder harness height, attach the shoulder strap hooks to the loops on the backrest at the appropriate height for your child.

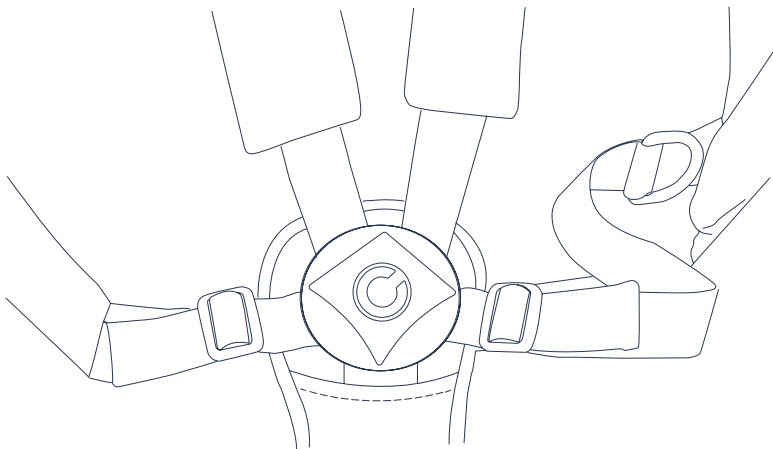
**USING THE BUCKLE**

To open the buckle, push the center button. To lock the buckle, insert each side until you hear a 'click.'

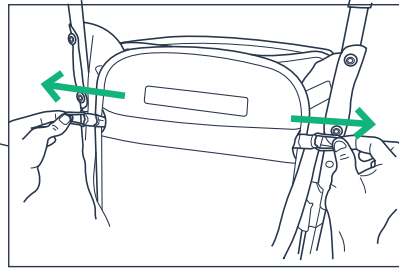
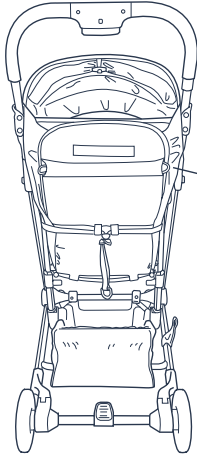

ADJUSTING THE BACKSTAY

When using the seatback in the upright position, hook the loops on both ends of the backstay around the bottom buttons on the frame.

Before reclining the seatback, unhook the loops from both bottom buttons on the frame.

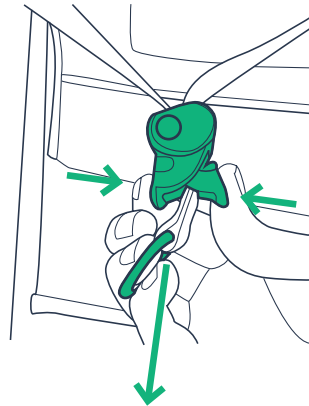
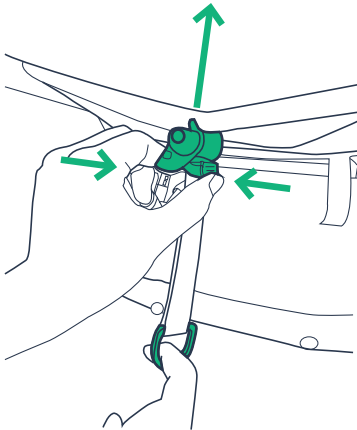

ADJUSTING THE BACKREST

To adjust the backrest, grasp the backrest adjustment buckle and push up (to move upward) or pull down (to move downward).

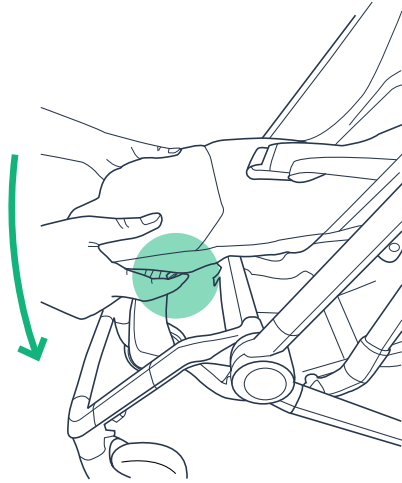

ADJUSTING THE FOOTREST

STEP 1 Slide the footrest adjustment levers toward the bottom of the footrest to unlock the footrest.

STEP 2 Adjust the footrest position upward or downward until it is locked in either the 'up' or 'down' position.

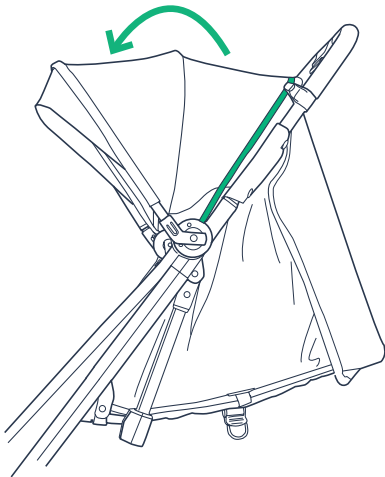

EXTENDING THE CANOPY

To fully extend the canopy, unzip the canopy extension.

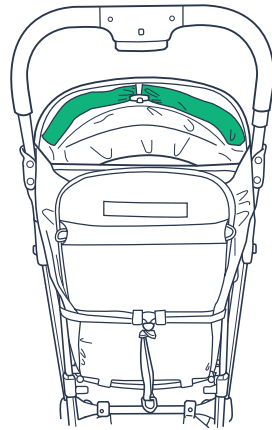

HIDING THE REAR CANOPY

To hide the rear canopy, unhook the velcro, roll from the bottom upward, and secure the rear canopy using the toggle and the elastic loop.

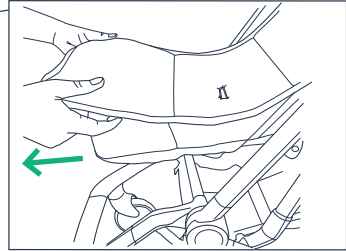
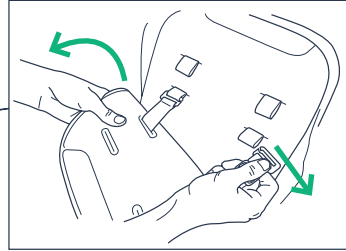
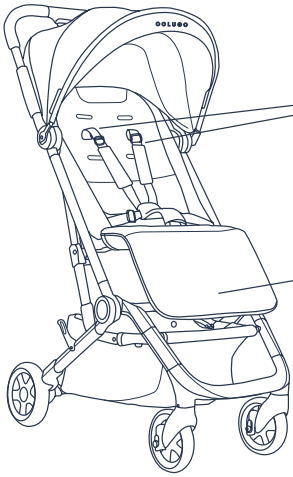

REMOVING THE COMFORT LAYER

STEP 1 Unbuckle the harness if necessary.

STEP 2 Detach the shoulder straps from the seatback.

STEP 3 Pull all straps through the comfort layer.

STEP 4 Slide comfort layer off the seat.

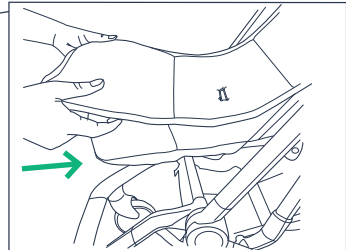
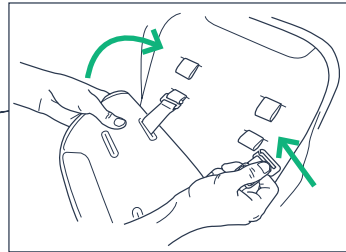
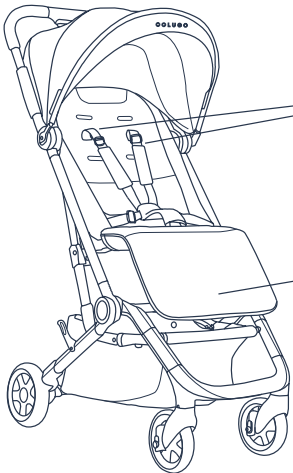

REPLACING THE COMFORT LAYER

STEP 1 Slide comfort layer onto footrest.

STEP 2 Pull all straps through the comfort layer.

STEP 3 Attach the shoulder straps to the seatback at the appropriate height for the child and slide the comfort layer onto the seat.

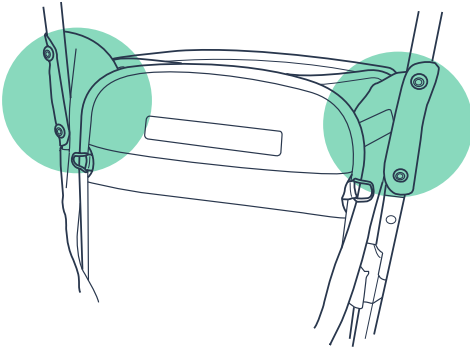
**STEP 1**

Unbutton the base layer from the frame (all 4 buttons).

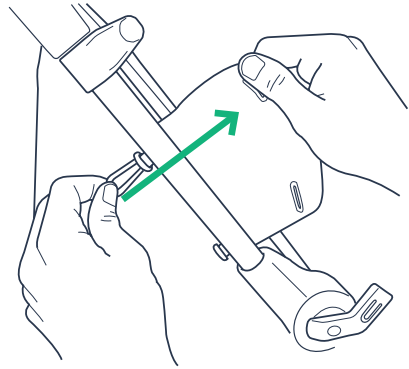
**STEP 2**

Unhook the canopy elastic bands from the buttons on the frame.

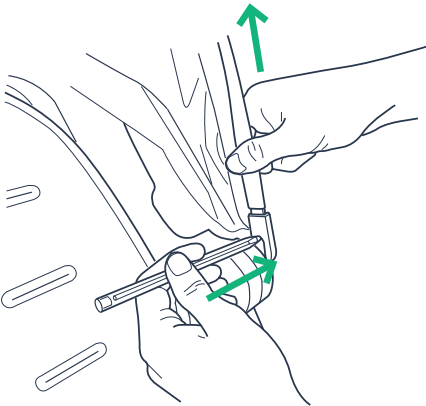
**STEP 3**

Remove the front canopy rods by pressing a ballpoint pen into the circular space on the inside of the canopy mount and pulling up on the front canopy rod. Remove the pen while pulling up. Complete on both sides.

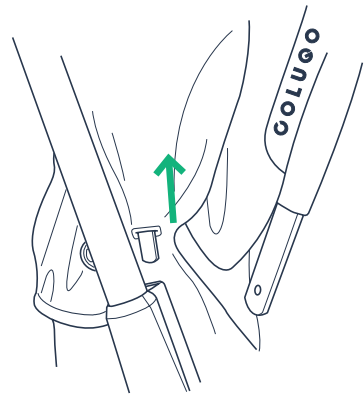
**STEP 4**

Remove the rear canopy rods.

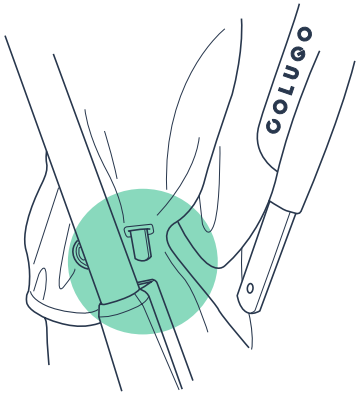

STEP 1

Thread the small canopy rods through the red button holes on the base layer and insert them into the small plastic slots on the stroller frame.

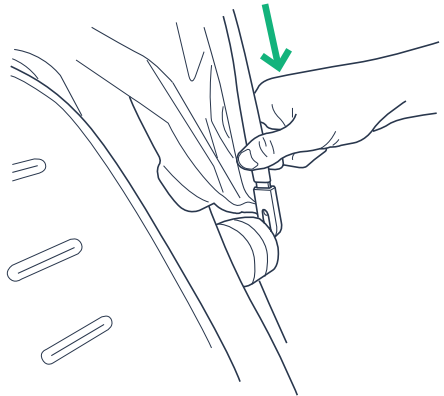

STEP 2

Insert the large canopy rods into the plastic slots on the canopy hinges.

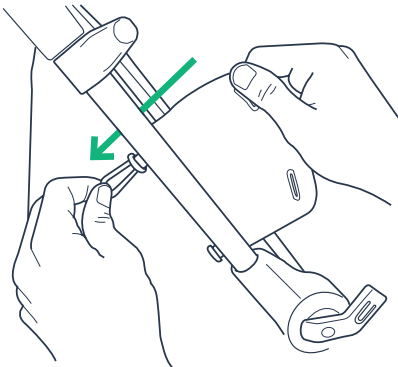

STEP 3

Stretch the canopy elastic band under the frame and onto the top button.

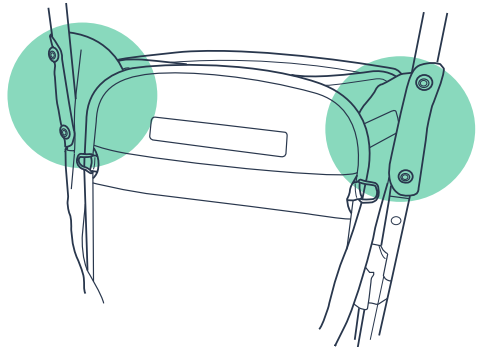

STEP 4

Button the base layer back onto the frame (all 4 buttons).

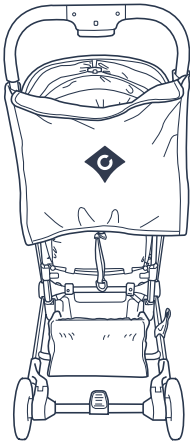

STEP 1

Attach the rain cover bag to the stroller frame (just under the handle) using the velcro straps on the outside of the bag. The Colugo logo should be facing out.

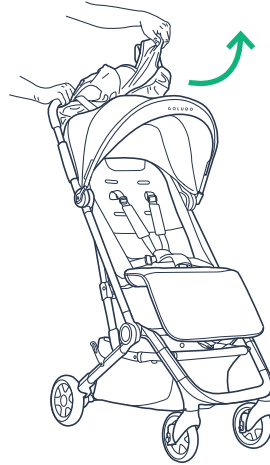

STEP 2

Pull the rain cover out from the bag *underneath the handle* and drape it over the stroller.

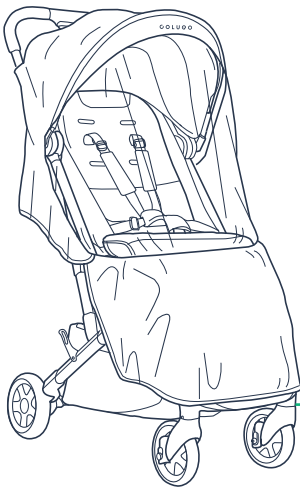

STEP 3

Secure the back flap of the rain cover on both sides using the velcro.

PRO-TIP

If it might rain, attach the rain cover bag before heading out the door.

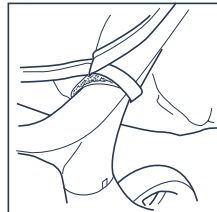

STEP 4

Attach the rain cover to the bottom of the stroller above the front wheels using the velcro straps.

COLUGO

www.hicolugo.com

STROVA, INC
3401 Grays Ferry Ave
Philadelphia, PA 19146