

**LET'S
GO**



Colugo Infant Carrier
Instructions

⚠ WARNING: FALL AND SUFFOCATION HAZARD

IMPORTANT: RETAIN FOR FUTURE REFERENCE.

Failure to follow these warnings and the assembly instructions could result in serious injury or death.

FALL HAZARD- infants can fall through a wide leg opening or out of carrier.

- Adjust leg openings to fit baby's leg snugly.
- Before each use, make sure all buckles and adjustments are secure.
- Take special care when leaning or walking. Never run.
- Never bend at waist; bend at knees.
- Only use this carrier for children between 7 lbs and 33 lbs
- Hold your baby closely at all times until correctly attached.
- Never lie down or sleep with baby in carrier.
- Never use a soft carrier while engaging in activities such as cooking and cleaning which involve a heat source or exposure to chemicals.

- Never use a soft carrier when balance or mobility is impaired because of exercise, drowsiness, or medical conditions.
- Never use a soft carrier while driving or being a passenger in a motor vehicle.

SUFFOCATION HAZARD- premature infants, infants with respiratory problems, and infants under 4 months can suffocate in this product if face is pressed tightly against body.

- Allow room for head movement.
- Keep infant's face free from obstructions at all times.

BEFORE USE

- Carefully read and follow all the instructions on labels and in the owner's manual provided with this product.
- Inspect the product regularly for wear and tear.
- Child must face towards you until he or she can hold head upright.

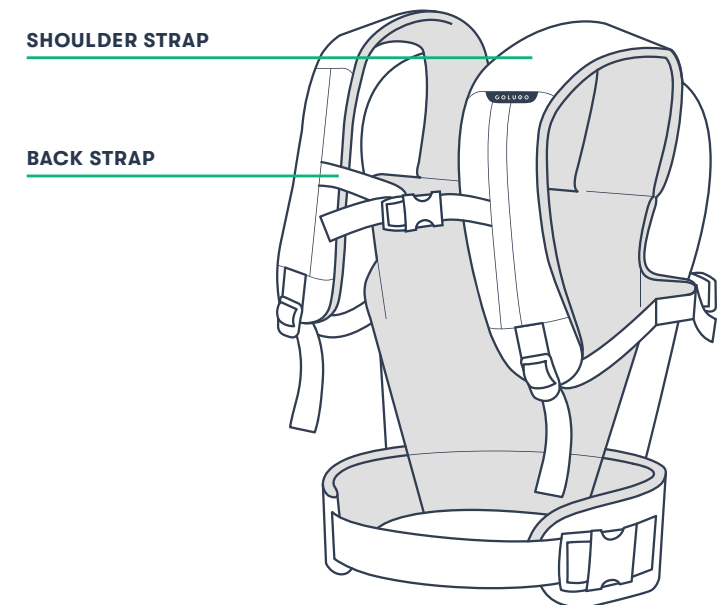
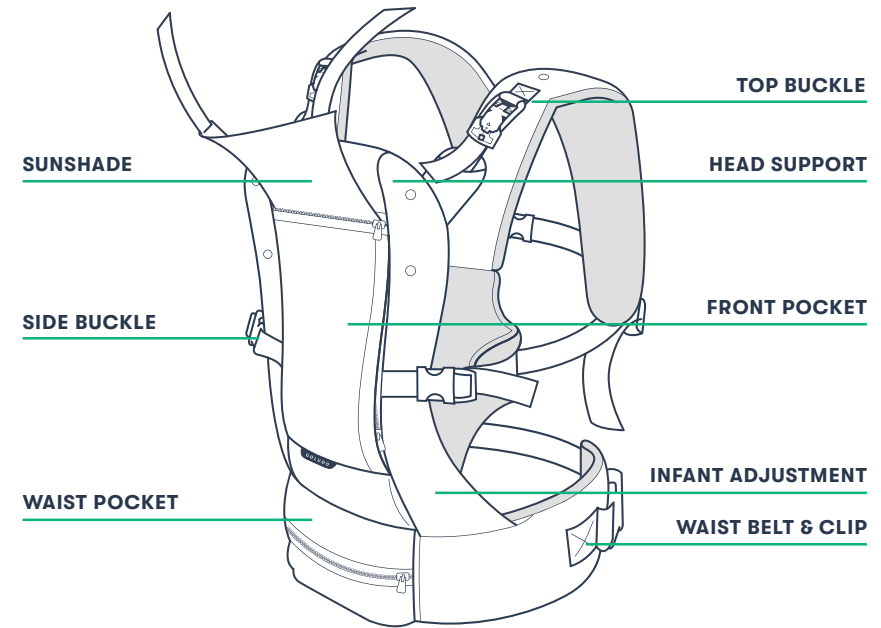

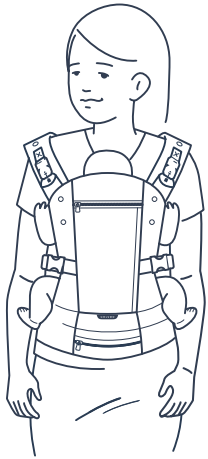

INFANT FACING IN

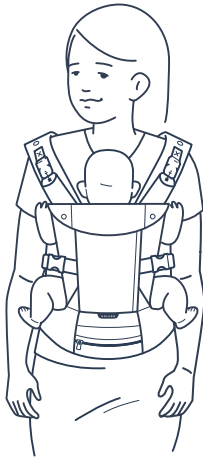

BABY FACING IN

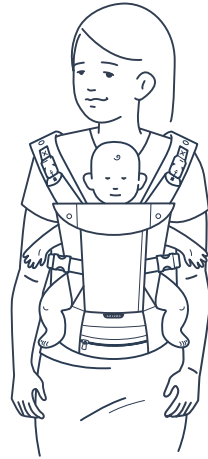

BABY FACING OUT

	INFANT	BABY	
	FACING IN	FACING IN	FACING OUT
APP. AGE	0-4 MOS	5 MOS+	5 MOS+
APP. WEIGHT	7-13 LBS	14-33 LBS	14-33 LBS
ADJUSTMENTS	INFANT ADJUSTMENT MUST BE IN DOWN POSITION	INFANT ADJUSTMENT MUST BE IN UP POSITION	

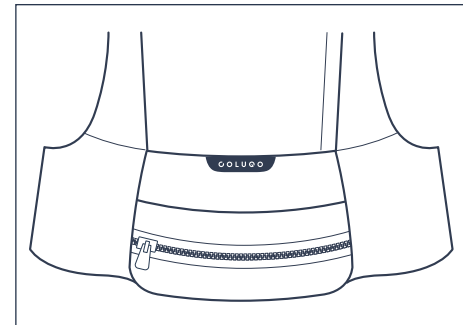
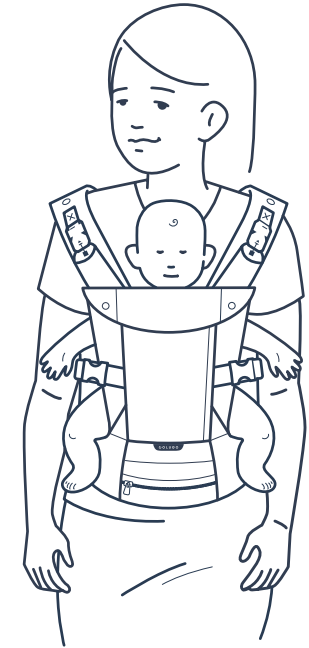
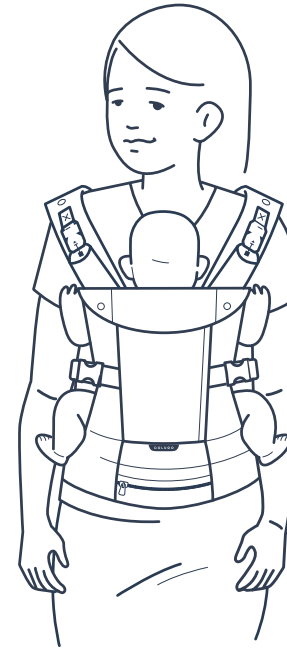

INFANT ADJUSTMENT DOWN
Insert the velcro supports into the waist belt.

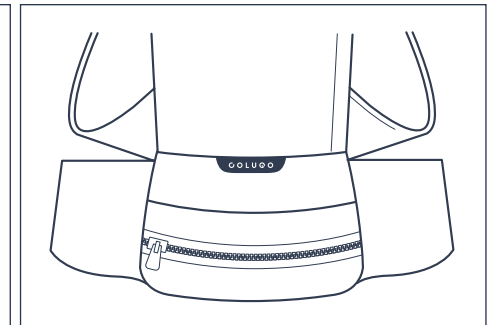

INFANT ADJUSTMENT UP
Insert the velcro supports into the front panel.

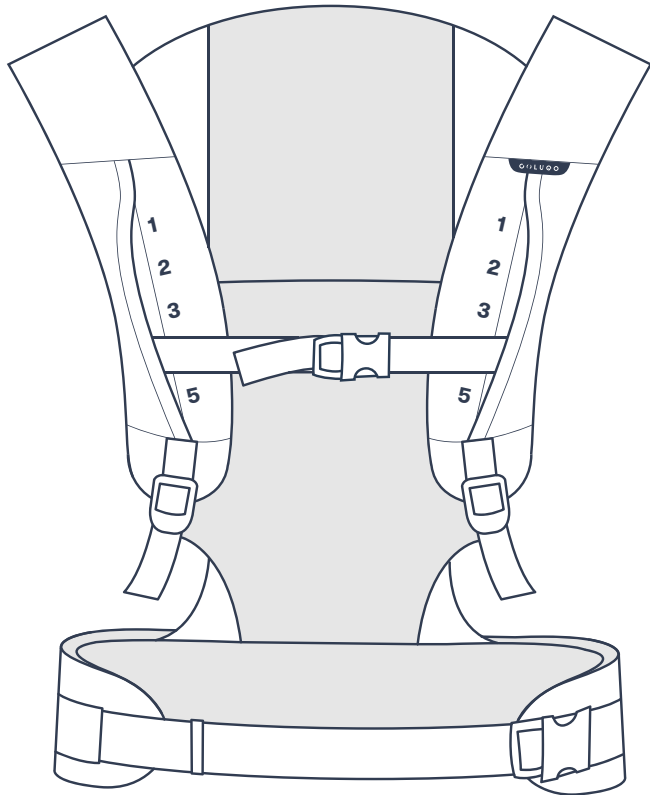

CUSTOM FITTING YOUR CARRIER

Your carrier comes with a custom fit system located on the back strap that makes it easy to share a carrier among many caregivers for your child. Prior to your first use, have someone help you determine your custom fit number by fastening and adjusting the height of the back strap while the carrier is on you. Then locate the number hidden on the shoulder strap - this is your custom setting. Each time you use the carrier, slide the back strap to your number - *this enables you to put on the carrier all by yourself!*



STEP 1

Adjust the back strap to your custom setting (1-5) and width.



STEP 2

Loosen the shoulder straps if necessary.

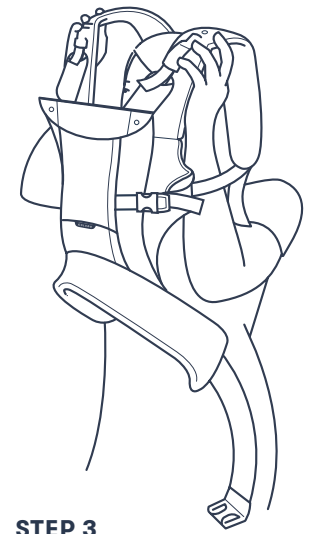

STEP 3

Pull the carrier over your head (like a t-shirt!).



STEP 4

Clip and tighten the waist belt.

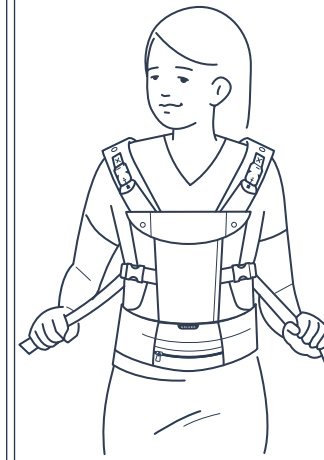

STEP 5

Tighten the shoulder straps to your desired tightness.

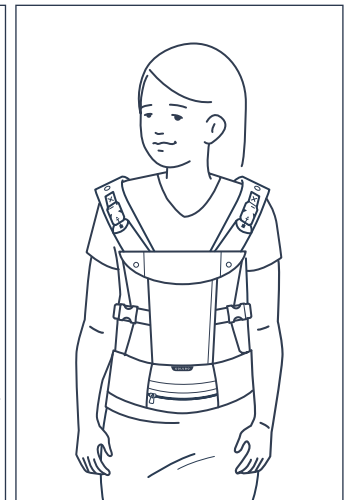

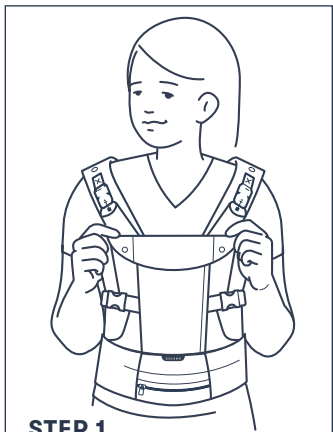

STEP 1
Fold down and fasten the the head support.



STEP 2
Unfasten the top buckles on both sides by pulling up on the pull tab. Unbutton the side buckle on one side.



STEP 3
Place your child in the carrier facing you with their legs on either side of the front and arms through armholes. Rest your child's arms above the arm holes if needed.



STEP 4
Fasten the side buckle. You will hear a 'click' when it is locked.



STEP 5
Fasten the top buckles. You will hear a 'click' when they are locked.

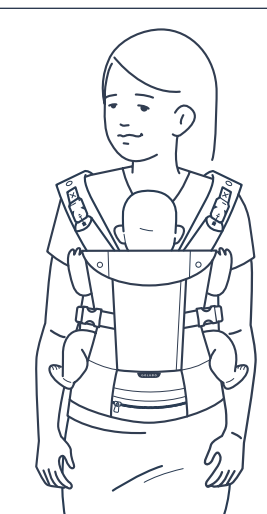

STEP 1
Fold down and fasten the head support.



STEP 2
Unfasten the top buckles on both sides by pulling up on the pull tab. Unfasten the side buckle on one side.



STEP 3
Place your child in the carrier facing away from you with their legs on either side of the front and arms through armholes. Rest your child's arms above the arm holes if needed.



STEP 4
Fasten the side buckle. You will hear a 'click' when it is locked.



STEP 5
Fasten the top buckles. You will hear a 'click' when they are locked.

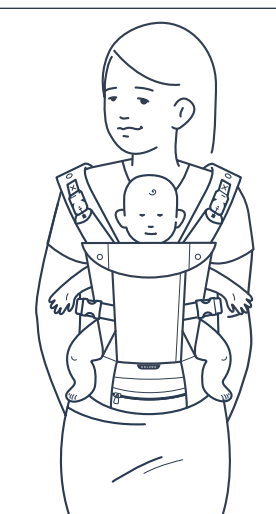



STEP 1
Unfasten the top buckles on both sides by pulling up on the pull tab. Unfasten the side buckle on one side.



STEP 2
Unfasten the side buckles on one or both sides.



STEP 3
Remove your child.



STORAGE
Your carrier comes with two special pockets - a waist pocket for small items like keys, wallets, and pacifiers and a front pocket on the body of the carrier to hold larger items like extra diapers, travel wipes, and change of clothing for your baby.



SUNSHADE
To use the sunshade, remove it from its storage pocket and snap it in place.



ROLLING YOUR CARRIER

STEP 1 Make sure your carrier's sunshade is out of its pocket.

STEP 2 Lay your carrier flat, face-down.

STEP 3 Tuck in waist belt and roll, tucking in shoulder straps as you go.

STEP 4 Wrap sunshade around your rolled carrier and fasten to the snaps on the head support.

COLUGO

www.hicolugo.com

STROVA, INC
3401 Grays Ferry Ave
Philadelphia, PA 19146