

# SOLIOS

## SIZING GUIDE

- 1 CASE
- 2 ECO LEATHER STRAPS
- 3 MESH STAINLESS STEEL STRAPS

# CASE

---

## 40mm Case

Best suited for medium to large wrists

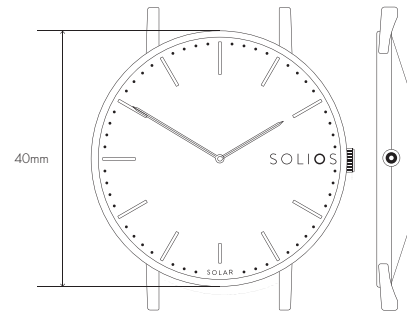
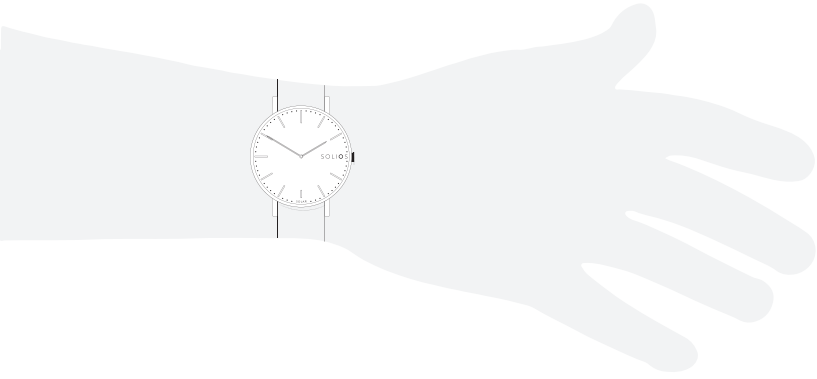

## 36mm Case

Best suited for smaller wrists

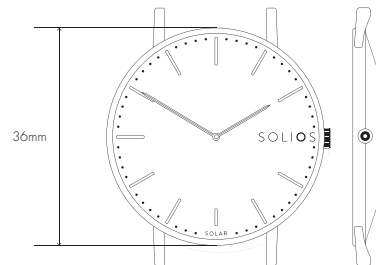
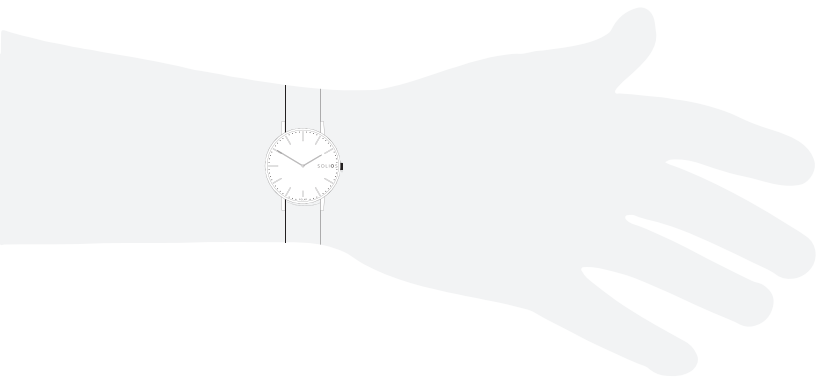

# ECO LEATHER STRAPS

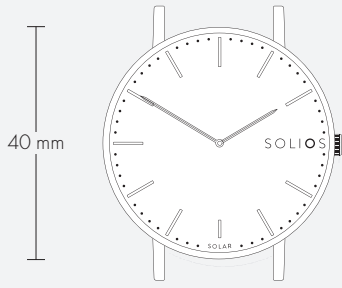

**20mm**  
For 40mm watches

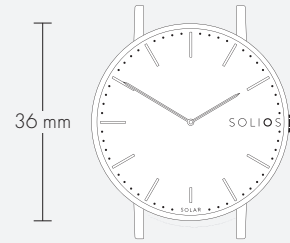

**18mm**  
For 36mm watches

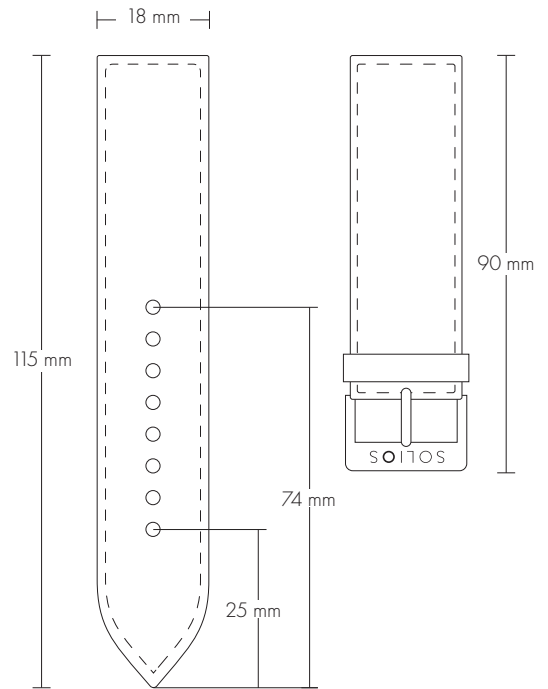
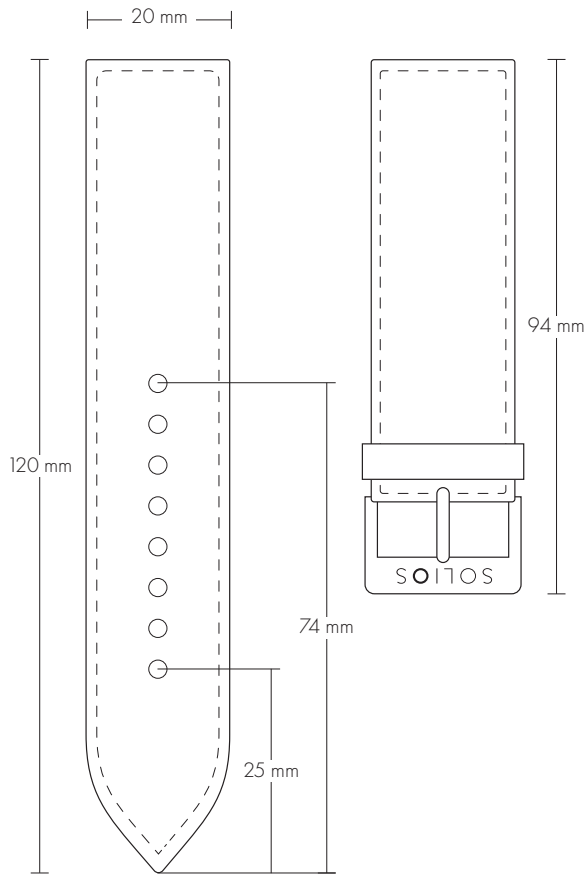

# MESH STAINLES STEEL STRAPS

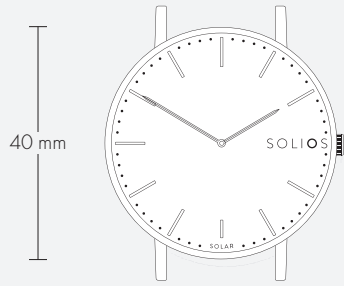

## 20mm- Small

For 40mm watches and smaller wrists

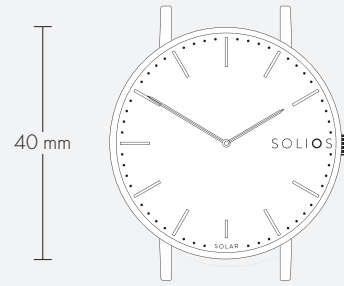

## 20mm- Large

For 40mm watches and bigger wrists

20 mm

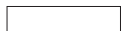

225 mm



Maximum Size 213 mm  
Minimum Size 113 mm

20 mm

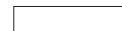

245 mm



Maximum Size 233 mm  
Minimum Size 133 mm



# MESH STAINLES STEEL STRAPS

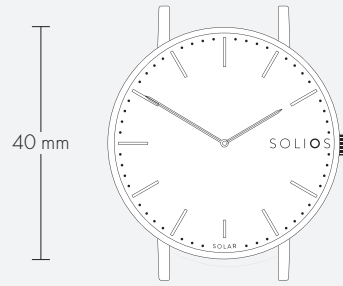

## 18mm- Small

For 36 mm watches and smaller wrists

18 mm

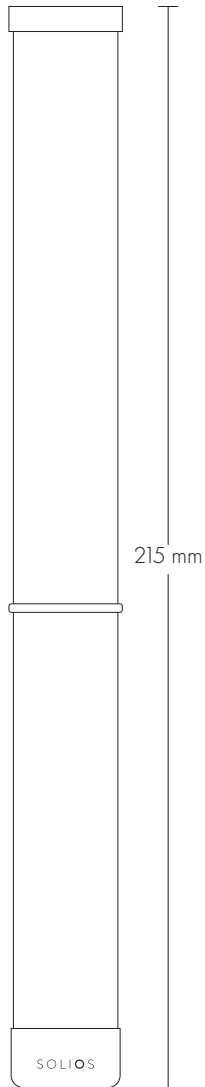

Maximum Size 203 mm Minimum Size 103 mm