

# Fire Pit Owner's Manual

For a safe and pleasurable heating experience, perform this check before each use

## Before Operating:

1. I am familiar with entire owner's manual and understand all precautions noted
2. All components are properly assembled, intact and operable
3. No alterations have been made
4. All gas connections are secure and do not leak
5. Wind velocity is below 10 mph
6. Unit will operate at reduced efficiency below 40 °P4.44 °C
7. Fire pit is outdoors (outside any enclosure)
8. There is adequate fresh air ventilation. Do not use this appliance if any part has been under water. Immediately call a qualified service technician to inspect the appliance and to replace any part of the control system and gas control which has been under water
9. Fire pit is away from gasoline or other flammable liquids or vapors
10. Fire pit is away from windows, air intake openings, sprinklers and other water sources
11. Fire pit is at least 36 in. on rear and at least 36 in. on sides from combustible materials
12. Fire pit is on a hard and level surface
13. There are no signs of spider or insect nests
14. All burner passages are clear
15. All air circulation passages are clear
16. Children and adults should be alerted to the hazards of high surface temperatures and should stay away to avoid burns or clothing ignition.
17. Young children should be carefully supervised when they are in the area of the fire pit.
18. Clothing or other protective material should not be hung from the fire pit, or placed on or near the fire pit

19. Any guard or other protective device removed for servicing the fire pit must be replaced prior to operating the fire pit
20. Installation and repair should be done by a qualified service person. The fire pit should be inspected before use and at least annually by a qualified service person
21. More frequent cleaning may be required as necessary. It is imperative that control compartment, burner and circulating air passageways of the fire pit be kept clean

## After Operation:

1. Gas control is in OFF position
2. Gas Tank valve is OFF
3. Disconnect Gas line
4. After each use, replace cap on tank

## PREPARATION :

Before beginning assembly of product, make sure all parts are present Compare parts with package contents list and hardware contents above. If any part is missing or damaged, do not attempt to assemble the product Contact customer service for replacement parts.

Estimated Assembly Time: 15 Minutes

Tools Required for Assembly (not included)  
Phillips screwdriver medium blade. Leak Detection Solution.

# FOR PROPANE OR NATURAL GAS

Electronic Ignition

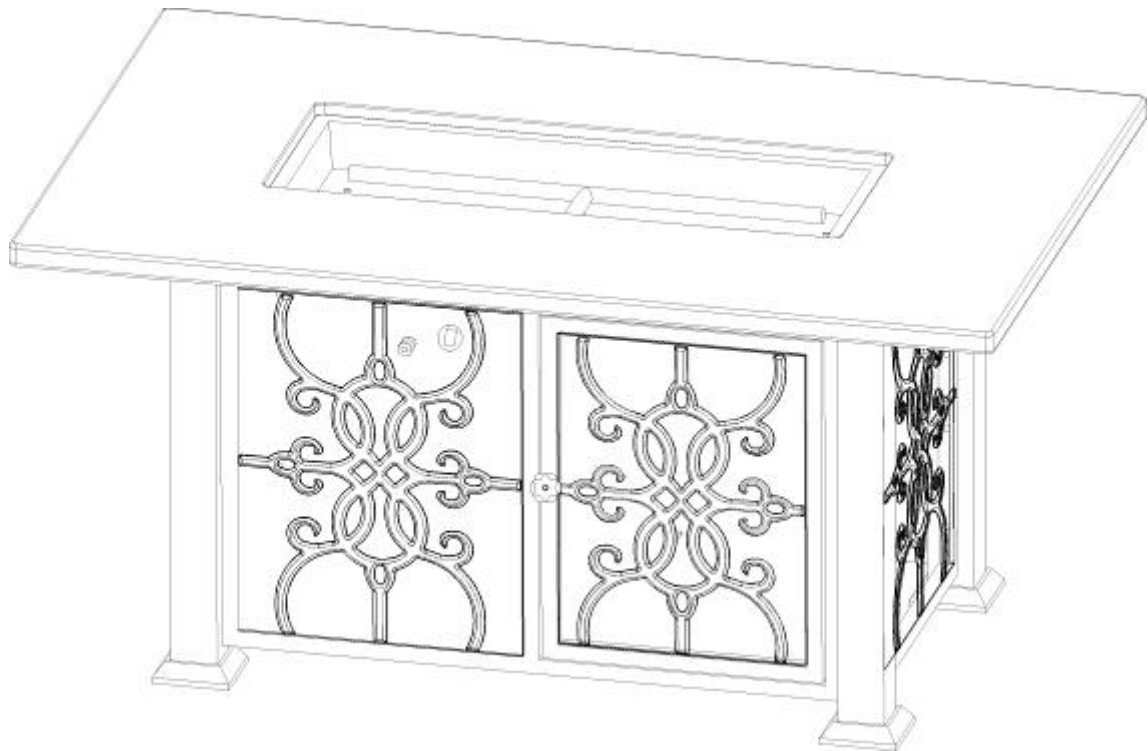

**WARNING : FOR OUTDOOR USE ONLY.**

## WARNING

### For Outdoor Use Only

**NOTE:** Read these instructions carefully before starting installation of the outdoor firepit

#### CODE AND SUPPLY REQUIREMENTS:

This outdoor fire pit must be installed in accordance with local codes and ordinances, or, in the absence of local codes, with the latest National Fuel Gas Code, ANSI Z223.1.

Installation and service must be performed by an NFI Certified or other qualified professional installer, service agency, or the gas supplier

#### INSTALLER & CONSUMER:

**For Outdoor Use Only**—If stored indoors, detach and leave cylinder outdoors

These instructions **MUST be** retained with this appliance for future reference

### WARNING:

 Do not store or use gasoline, or other flammable vapors and liquids in the vicinity of this or any other appliance.

 An LP-cylinder not connected for use shall not be stored in the vicinity of this or any other appliance.

Improper installation, adjustment, alteration, service, or maintenance can cause property damage, personal injury, or loss of life. Refer to this manual. For assistance or additional information, consult a qualified professional installer, service agency, or the gas supplier.

### IMPORTANT

For safe operation and proper performance of this product and to comply with certification, listings, and building code acceptances, use only our controls, parts, and accessories that have been specifically listed or certified for use with this burner system. Use of other controls, parts, or accessories is prohibited and will void all warranties, certifications, listings, and building code approvals, and may cause property damage, personal injury, and loss of life.

### DANGER

If you smell gas:

- Shut off gas appliance.
- Extinguish any open flame.
- If odor continues, keep away from appliance and immediately call your gas supplier or fire department.



#### CARBON MONOXIDE HAZARD:

- This appliance can produce carbon monoxide which has no odor.
- Using it in an enclosed space can kill you.
- Never use this appliance in an enclosed space such as a camper, tent, car or home.

## PRE-INSTALLATION AND PREPARATION SAFETY

- A. Before installing this unit, check the MINIMUM CLEARANCE TO COMBUSTIBLES section to ensure that the surrounding area is **properly sized for the installation**.
- B. The unit is for outdoor use only. **DO NOT** install or use this appliance inside a building, garage, or any other enclosed area, including recreational vehicles and/or boats. **This unit must be installed in such a manner that the vent opening at the base of the unit remains clear and free of all obstructions at all times and during all weather conditions.**
- C. CHECK GAS TYPE (natural gas or propane): The gas supply you intend to use may not be the same as that stated on the unit rating plate as purchased. If the gas supply is different, **convert the unit to the gas type you intend to use**. See the CONVERTING TO A DIFFERENT GAS TYPE SECTION. If you are unsure, contact the dealer for assistance. ONLY MANUAL UNITS ARE CONVERTIBLE.
- D. D. FOR NATURAL GAS: The minimum inlet gas-supply pressure for purposes of input adjustment is S-S' water column (W.C.), and the maximum inlet gas-supply pressure is 10.5 " W.C. FOR PROPANE: The minimum inlet gas-supply pressure for purposes of input adjustment is 8" W.C., and the maximum inlet gas-supply pressure is 13" W.C. DO NOT INSTALL THIS UNIT IF MINIMUM PRESSURE IS NOT AVAILABLE OR IF MAXIMUM PRESSURE IS EXCEEDED.
- E. FOR PROPANE: The minimum inlet gas-supply pressure for purposes of input adjustment is 8" W.C., and the maximum inlet gas-supply pressure is 10" W.C. DO NOT INSTALL THIS UNIT IF MINIMUM PRESSURE IS NOT AVAILABLE OR IF MAXIMUM PRESSURE IS EXCEEDED.
- F. Gas piping system must be sized to provide minimum inlet pressure at the maximum flow rate (BTU/hr). Undue pressure loss will occur if the pipe is too small, or the run is too long.
- G. For installations at elevations above 2,000 ft., contact your local dealer or gas supplier before installing. Input ratings should be reduced approximately 4% for each 1,000 ft. above sea level. Refer to the National Fuel Gas Code.
- H. The unit and its individual shutoff valve must be disconnected from the gas-supply piping system during any pressure testing of that system at test pressures in excess of 1/2 psi (3.5 KPA). This is accomplished by closing the gas-supply line valve. The unit must be isolated from the gas-supply piping system by closing its individual manual shutoff valve during any pressure testing of the gas-supply piping system at test pressures equal to or less than 1/2 psi (3.5 KPA).
- I. INSTALLER NOTE: This unit should be installed so that it can be removed if service is required.

### GAS-SUPPLY PLUMBING REQUIREMENTS

Apply only joint compounds that are resistant to all gases on all male pipe fittings. Make sure to tighten every joint securely. Do not use pipe joint compound to connect flare fittings. Bring the gas-supply pipe up from beneath the enclosure near its center (if applicable).

## **CAUTION**

**Installation and maintenance must be done by an NFI Certified or other qualified professional installer. Installer read these instructions before installing this product. Be sure you understand all safety precautions and warnings contained in this manual.**

## **NOTE:**

**An external on/off valve in the gas line is required for safety when the unit is not in use. It also provides for convenient maintenance and repair.**

# Installation Instructions

**FIRE TABLE ASSEMBLY** - Place the tabletop on top of the frame, making sure to line the posts to the frame. Secure with the nut and washers.

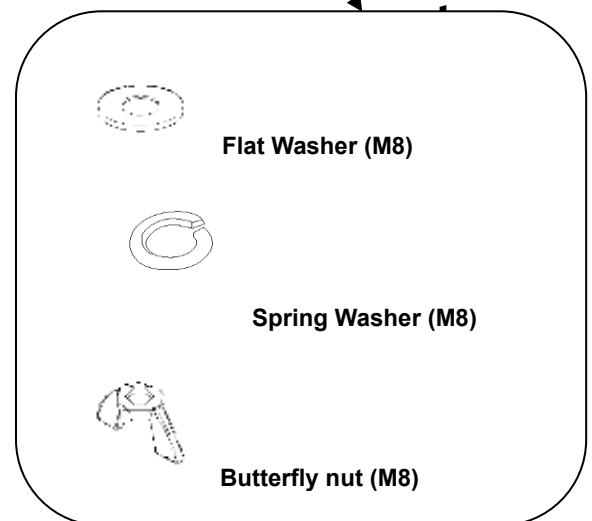
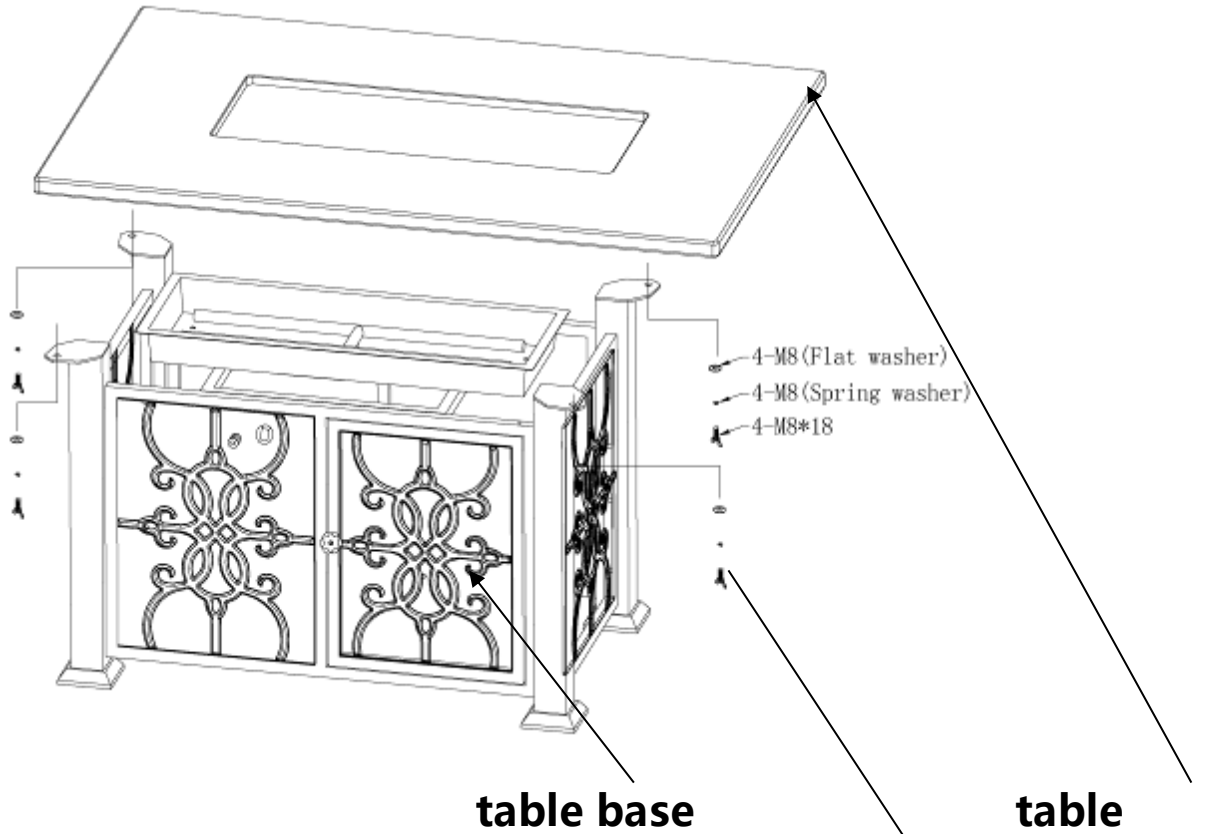

# INSTALLATION (Cont.)

## LOCATION

While following all requirements and safety information in this manual; locate the unit on a flat, level surface.

## CONNECT TO A PROPANE CYLINDER GAS SUPPLY

**Important:** Before installation, be sure the propane cylinder is turned off.

1. Attach the regulator end to the propane cylinder and tighten (see Fig.11-1). Follow all instructions and safety warnings supplied with the propane cylinder.
2. Place the cylinder in the tank seat, and rotate the screw clockwise to a fully stop. (see Fig.11- 2).

## CONNECT TO A NATURAL OR HOUSEHOLD PROPANE

### GAS SUPPLY

1. Connect a flex connector (not supplied) to the unit using a gas pipe sealing compound or Teflon Tape (see Fig. 11-3).
2. Bring the gas-supply pipe up from beneath the unit near its center.

Note: Locate the gas supply line out of pathways where people may trip over it or in areas where the line may be subject to accidental damage.

3. Install a flare adaptor (not supplied) to the gas supply (NPT) using a gas pipe sealing compound or Teflon tape (see Fig. 11-3).
4. Connect the flex connector to the flare adaptor (see Fig.11-3).

## LEAK TEST

Turn on the gas supply, ignite the burner, and test at all connections for leaks using a soapy water solution. If bubbles appear, a leak is present. Turn off the gas and tighten at all connections. Repeat until no leaks are present. If a leak persists, turn off the gas supply and contact the local gas

company or dealer. **NEVER USE A FLAME TO CHECK FOR LEAKS.**

\*The gas hose connector shall have a connector that complies with the Standard for Gas Hose Connectors for Portable Outdoor Gas-Fired Appliances, ANSI Z21.54 CSA 8.4.

Fig.11-1 Propane cylinder

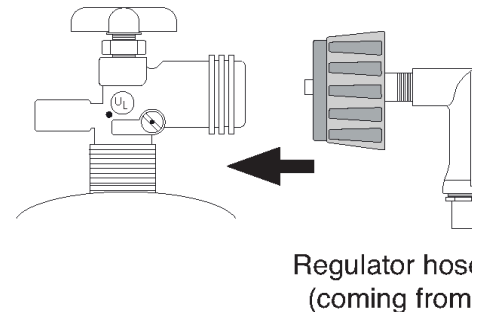
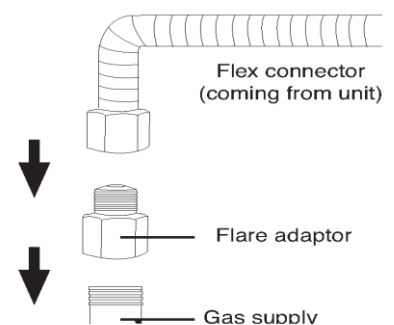

Fig.11-3



# OPERATING THE UNIT-LIGHTING AND EXTINGUISHING

## FOR YOUR SAFETY, READ BEFORE LIGHTING

WARNING: IF YOU DO NOT FOLLOW THESE INSTRUCTIONS EXACTLY, A FIRE OR EXPLOSION MAY RESULT, CAUSING PROPERTY DAMAGE, PERSONAL INJURY, OR LOSS OF LIFE.

**A. BEFORE LIGHTING**, smell all around the unit area for gas. Be sure to smell next to the floor, because some gas is heavier than air and will settle on the floor.

**B. WHAT TO DO IF YOU SMELL GAS**

1. Shut off the gas to the appliance.
2. Extinguish any open flame.
3. If odor continues, immediately call your gas supplier or the fire department.

**C.** Use only your hand to push in or turn the gas control knob. Never use tools. If the knob will not push in or turn by hand, **DO NOT** try to repair it. Call a qualified professional service technician. Force or attempted repair may result in fire or explosion.

## ELECTRONIC LIGHTING INSTRUCTIONS

1. STOP! Read the safety information above.
2. Unscrew Electronic Ignitor head and insert AA Battery
3. Push and slowly turn the control knob to the HIGH position
4. Hold the ignitor to light the burner release control knob after 45 seconds. See p1
5. Observe the flame height when lit. Flame should be to 13 inches high. See P2
6. If the burner does not light after 45 seconds of having the gas on, then immediately turn the control knob to the OFF position.
7. Wait approximately five minutes to clear out any gas, and repeat steps 1-4 above.
8. If your burner fails to light again, turn the control knob to the OFF position and contact your dealer or gas supplier.
9. To extinguish your gas burner, turn the control knob to the OFF position. Be sure the control knob is turned fully off to avoid any gas leakage

P1



P2



Pictorial representation of approximate flame

Each installation site for any unit presents its own unique combustion environment. Specific factors such as weather, wind currents, yard debris, altitude, drafts, the size of the surrounding area, all have an influence on the proper operation of the unit. A normally operating unit will demonstrate the following characteristics:

a) A lively, realistic yellow flame,

b) Odor-free.

· If the flame is not clean (identifiable by excessive sooting on the decorative media), refer to the **CLEANING AND MAINTENANCE** section below.

A. Always shut off the gas to the unit while performing service work.

B. Allow the unit to cool before servicing.

C. The unit should be inspected regularly. Excessive debris can build up on this unit from leaves, dirt, or other debris. It is critical that all control components, burners, and the surrounding area be kept clean and free of all obstructions.

Keep the surrounding area at the base of the unit clean and free of obstructions at all times.

D. The burner assembly must be replaced prior to the unit being put into operation if it is evident that the burner is damaged. Contact your local dealer for replacement parts.

E. Periodically perform visual checks of the burner flames. The burner flames should be blue at the base with a combination of blue/yellow at the body and tips .Contact a qualified service person for maintenance.

Keep entire area (around bottom) clear for proper venting

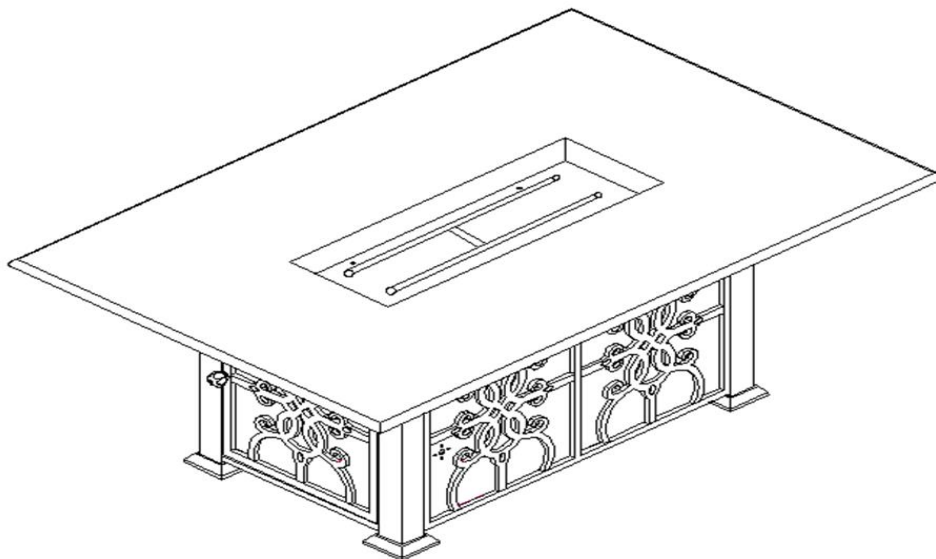

## **CAUTION**

### **HOT DURING OPERATION AND AFTER USE**

Children must be supervised when in the vicinity of this appliance. Serious injury may occur! Children must be alerted to the hazard of high surface temperatures and should stay away to avoid burns or clothing ignition.



# IMPORTANT SAFETY INFORMATION

## BE CAREFUL

If not installed and used correctly per these instructions,

This product can cause serious injury

**CAUTION:** Installation and maintenance must be done by an NFI Certified or other qualified professional installer. Read these instructions before installing this outdoor fire-pit. Be sure you understand all safety precautions and warnings contained in this manual.

A. FOR OUTDOOR USE ONLY. THIS UNIT MUST BE INSTALLED AT LEAST 36" FROM ANY COMBUSTIBLE WALLS OR MATERIAL. IT MUST NOT BE INSTALLED UNDER ANY TYPE OF CEILING OR OVERHANG (SEE FIG. 9-1).

B. When shutting the unit down—be sure to TURN THE CONTROL VALVE FULLY OFF.

**WARNING: CARBON MONOXIDE POISONING MAY LEAD TO DEATH. DO NOT MODIFY THIS OUTDOOR FIREPIT OR ITS CONTROLS, EXCEPT AS PROVIDED FOR IN THIS MANUAL.** Any other change may be dangerous. Improper installation or use of the outdoor fire-pit can cause serious injury or death from fire, burns, explosions, or carbon monoxide poisoning.

C. Check state and local codes to determine if the outdoor fire-pit is permitted in your locality before

Fig.1

Note: Nothing should be above the outdoor firepit.

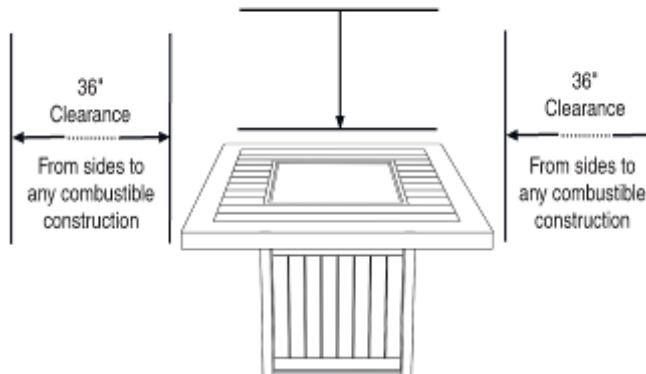

### Clearance to combustible construction:

Side walls: 36 "from edge of top ring (Fig.1).

Ceiling: **Nothing should be above the outdoor fire pit.**

Flooring: 0 "-Can be installed on desk, floor, etc .

The dimensions shown in Fig.1 are **MINIMUM CLEARANCES** to maintain when you install this outdoor fire pit. All sides of the enclosure opening must be at least 36 " from any combustible side walls. The unit must not be installed under any type of ceiling or overhang.

**1. Please check the battery**

- Use AA battery
- Ensure the position of the battery is as shown below

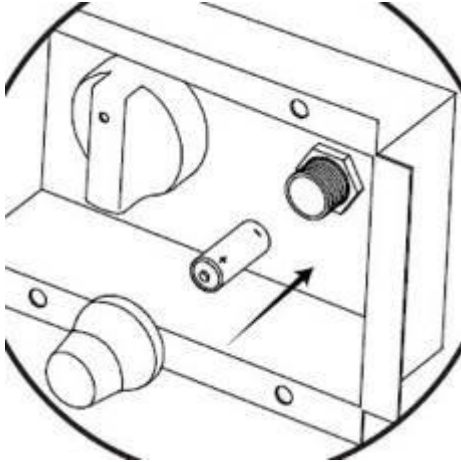

**2. If battery is not the problem, please follow the below steps for igniting:**

- Push and hold red button (igniter) first. While you hear the sound, then start to press in and turn the knob from **OFF** to **HI**.
  - Don't turn KNOB to Hi before you push red button (igniter).
- After the flame is ignited, then keep pressing and holding the knob at least 3 to 5 seconds.
  - Don't release the knob too soon after the flame is ignited.

**3. Ensure the gas collector cover is not covered with fire-glass or lava rock.**

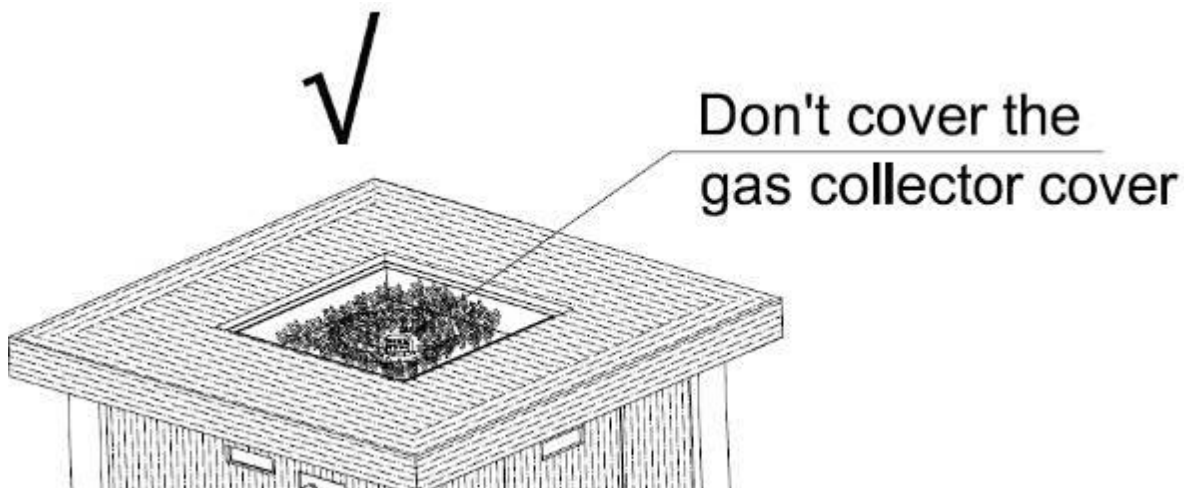



























**4. If Fire Table ignites but flame is low or does not last long:**



- Ensure you are using a new, properly functioning propane tank.
- Ensure propane tank is in upright position inside of fire table.
- Ensure propane tank is fully turned on.

## **DANGER**

Failure to follow the Dangers, Warnings and Cautions contained in this Owner's Manual may result in serious bodily injury or death, or in a fire or an explosion causing damage to property.

## **WARNING**

-  **\*Do not use this fire pit for cooking.**
-  \*Do not burn any other materials than are supplied with and intended for use in this fire pit.
-  \*Do not pour water into fire pit.
-  \*The installation of this product must conform with local codes.
-  \*Do not use this fire pit if any part has been under water.
-  \*Do not store a spare or disconnected liquid propane cylinder under or near this fire pit.
-  \*After a period of storage, and/or non use, the propane fire pit should be checked for gas leaks and burner obstructions before use. \*Do not operate the propane fire pit if there is a gas leak present.
-  \*Never use a flame to check for gas leaks.
-  \*Combustible materials should never be within 10 feet of the top, back or sides of your propane fire pit.
-  \*Do not put any other fire pit cover or anything flammable on, or beneath the fire pit.
-  \*The propane fire pit should never be used by children. Children must be supervised when they are anywhere near the appliance. \*Users should be alerted to the hazards of high surface temperatures and keep a safe distance to avoid burning or clothing ignition. \*Pay attention when operating the fire pit. It is hot in use and should never be left unattended. Do not transit it while in operation. \*Should fire go out while burning, turn the gas valve off. Follow the instruction and wait five minutes before attempting to relight. \*Never use charcoal or any other solid fuel in the fire pit. Never parch clothing or other flammable materials on or near the fire pit. \*Never lean over the open fire pit or place hands or fingers on the upper portion of an operational unit.
-  \*Keep ventilation openings in cylinder enclosure (FIRE PIT BODY) free and clear of debris.
-  \*Do not rest feet on the fire pit.
-  \*Please take out the battery when not using the fire pit for an extended length of time.
-  \*Do not enlarge valve orifices or burner ports when cleaning the valve or burner.
-  \*Cylinder supply system must be arranged for vapor withdrawal \*LP Tank used must include a collar to protect the cylinder valve \*Never fill the cylinder beyond 80% full
-  \*Liquid propane gas is not natural gas. Only use propane for this fire pit.
-  \*The conversion or attempted use of natural gas in a liquid propane unit or liquid propane gas in a natural gas unit is dangerous. \*Do not use this fire pit on vehicles or boats. Always operate the appliance on flat ground outdoors.
-  \*Keep any electrical supply cord and the fuel supply hose away from any heated surfaces.
-  \*Do not use this fire pit unless all parts are in place.
-  **FOR LIQUID PROPANE GAS UNITS**
-  \*Do not attempt to disconnect the gas regulator or any gas fitting while your fire pit is in operation.
-  \*A dented or rusty liquid propane cylinder may be hazardous and should be checked by your gas supplier prior to use.
-  \*Do not use a liquid propane cylinder with a damaged valve and any other worn out parts.
-  \*Transit and store the empty gas cylinders carefully and properly.
-  \*If you see, smell or hear the hiss of escaping gas from the liquid propane cylinder:
  1. Turn off the gas supply and get away from the gas cylinder and the fire pit at once.
  2. Do not attempt to correct the problem yourself.
  3. Get to your gas supplier and/or the fire department for help.

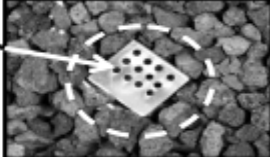
 <b><u>WARNING</u></b>	Screen 
 This screen must be clear and free of obstructions at all times to insure proper operation.	 <p>DO NOT PLACE LAVA ROCKS ON THE SCREEN. KEEP SCREEN CLEAR.</p>