

INSTRUCTION MANUAL

for the

EMS 7500



INDEX

Chapter	Contents	Page
1.	Introduction	1
2.	Cautions	3
3.	Warnings	4
4.	Contraindication	5
5.	Adverse Reactions	5
6.	General Description	5
7.	Construction	6
8.	Technical Specifications	8
9.	Replaceable Parts	10
10.	Accessories	10
11.	Graphic Symbols	11
12.	Operating Instructions	11
13.	Attachment of Electrodes Lead Wires	12
14.	Lead Wire Maintenance	13
15.	Electrode Options	13
16.	Electrode Placement	13
17.	Tips For Skin Care	14
18.	Application of Re-usable Self Adhesive Electrodes	15
19.	Adjusting the Controls	16
20.	Battery Information	22
21.	Maintenance, Transportation and Storage	23
22.	Safety Control	24
23.	Malfunctions	24
24.	Conformity to Safety Standards	25
25.	Warranty	25

Chapter 1: INTRODUCTION

EXPLANATION OF EMS

Electrical Muscle Stimulation is an internationally accepted and proven way of treating muscular injuries. It works by sending electronic pulses to the muscle needing treatment; this causes the muscle to exercise passively.

It is a product derived from the square waveform, originally invented by John Faraday in 1831. Through the square wave pattern it is able to work directly on muscle motor neurons. The EMS 7500 has low frequency and this in conjunction with the square wave pattern allows direct work on muscle groupings. This is being widely used in hospitals and sports clinics for the treatment of muscular injuries and for the re-education of paralyzed muscles, to prevent atrophy in affected muscles and improving muscle tone and blood circulation.

HOW EMS WORKS

1. Relaxation of muscle spasms
2. Prevention or retardation of disuse atrophy
3. Increasing local blood circulation
4. Muscle re-education
5. Immediate post-surgical stimulation of calf muscles to prevent venous thrombosis
6. Maintaining or increasing range of motion

The EMS units send comfortable impulses through the skin that stimulate the nerves in the treatment area. When the muscle receives this signal it contracts as if the brain has sent the signal itself. As the signal strength increases, the muscle flexes as in physical exercise. Then when the pulse ceases, the muscle relaxes and the cycle

2

starts over again, (Stimulation, Contraction and Relaxation.) Powered muscle stimulators should only be used under medical supervision for adjunctive therapy for the treatment of medical diseases and conditions.

IMPORTANT SAFETY INFORMATION

Read instruction manual before operation. Be sure to comply with all "CAUTIONS" and "WARNINGS" in the manual. Failure to follow instructions can cause harm to user or device.

Chapter 2: CAUTIONS

1. Federal law (USA) restricts this device to sale by or on the order of a physician
2. Safety of powered muscle stimulators for use during pregnancy has not been established.
3. Caution should be used for patients with suspected or diagnosed heart problems.
4. Caution should be used for patients with suspected or diagnosed epilepsy.
5. Caution should be used in the presence of the following:
 - a. When there is a tendency to hemorrhage following acute trauma or fracture;
 - b. Following recent surgical procedures when muscle contraction may disrupt the healing process;
 - c. Over the menstruating or pregnant uterus; and
 - d. Over areas of the skin which lack normal sensation.
6. Some patients may experience skin irritation or hypersensitivity due to the electrical stimulation or electrical conductive medium. The irritation can usually be reduced by using an alternate conductive medium, or alternate electrode placement.

3

7. Electrode placement and stimulation settings should be based on the guidance of the prescribing practitioner.
8. Powered muscle stimulators should be kept out of the reach of children.
9. Powered muscle stimulators should be used only with the leads and electrodes recommended for use by the manufacturer.
10. Portable powered muscle stimulators should not be used while driving, operating machinery, or during any activity in which involuntary muscle contractions may put the user at undue risk of injury.

Chapter 3: WARNINGS

1. The long-term effects of chronic electrical stimulation are unknown.
2. Stimulation should not be applied over the carotid sinus nerves, particularly in patients with a known sensitivity to the carotid sinus reflex.
3. Stimulation should not be applied over the neck or mouth. Severe spasm of the laryngeal and pharyngeal muscles may occur and the contractions may be strong enough to close the airway or cause difficulty in breathing.
4. Stimulation should not be applied transthoracically in that the introduction of electrical current into the heart may cause cardiac arrhythmias.
5. Stimulation should not be applied transcerebrally.
6. Stimulation should not be applied over swollen, infected, or inflamed areas or skin eruptions, e.g., phlebitis, thrombophlebitis, varicose veins, etc.
7. Stimulation should not be applied over, or in proximity to, cancerous lesions.

Chapter 4: CONTRAINDICATION

Powered muscle stimulators should not be used on patients with cardiac demand pacemakers.

Chapter 5: ADVERSE REACTIONS

Skin irritation and burns beneath the electrodes have been reported with the use of powered muscle stimulators. If skin irritation occurs, discontinue use and consult your physician.

Chapter 6: GENERAL DESCRIPTION

The EMS 7500 is a battery operated pulse generator that sends electrical impulses through electrodes to the body and reaches the underlying nerves or muscle group. The device is provided with two controllable output channels, each independent of each other. An electrode pair can be connected to each output channel.

The electronics of the EMS 7500 create electrical impulses whose Intensity, Pulse Width, Pulse Rate, Contraction, Relaxation and Ramp may be altered with the switches. Press buttons are very easy to use and the panel cover prevents accidental changes in the setting.

Chapter 7 : CONSTRUCTION

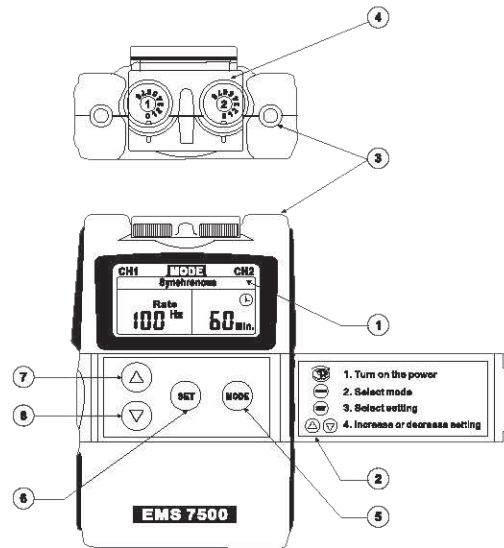

FRONT

- (1) LIQUID CRYSTAL DISPLAY
- (2) PANEL COVER
- (3) LEAD CONNECTOR
- (4) INTENSITY CONTROL
(ON/OFF SWITCH)
- (5) MODE CONTROL
- (6) SET CONTROL
- (7) INCREMENT CONTROL
- (8) DECREMENT CONTROL

6

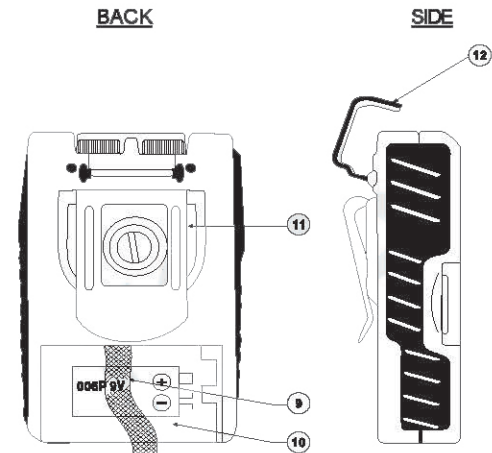

BACK

- (9) BATTERY STRIP
- (10) BATTERY CASE
- (11) BELTCLIP

SIDE

- (12) PROTECTIVE COVER

7

Chapter 8: TECHNICAL SPECIFICATION

The technical specification details of EMS 7500 are as follows.

	MECHANISM	TECHICALDESCRIPTION
01	Channel	Dual, isolated between channels
02	Pulse Amplitude	Adjustable 0-100 mA into 500 ohm load each channel.
03	Output Voltage	Adjustable 0-50V, Max output 50V peak to peak into 500ohm load each channel.
04	Wave Form	Asymmetrical rectangular biphasic pulse.
05	Power Supply	One 9 Volt Battery, type 6F22
06	Size	10.1cm(L) x 6.1cm(W) x 2.45cm(H)
07	Weight	150 grams (battery included)
08	On Time	Adjustable, 2~90 seconds , 1 Sec./ step
09	Off Time	Adjustable, 0~90 seconds , 1 Sec./ step
10	Ramp Time	Adjustable, 1~8 seconds, 1 Sec./ step, The "On" time will increase and decrease in the setting value.
11	Pulse Rate	Adjustable, 2~150 Hz , 1Hz / step
12	Pulse Width	Adjustable, 50~300 μ s , 10 μ s / step
13	Timer	Adjustable, 1-60 minutes or Continuous. Adjustable in 1 minute each step from 1 to 15 minutes, and 5 minutes each step from 15 to 60 minutes. Treatment time count down automatically.
14	Output Mode	Constant ,Synchronous, Alternate
15	Constant	Constant stimulation based on setting value. Only pulse width, pulse rate and timer are adjustable in this mode. "Constant" is equal to the "Normal" mode of a TENS unit.

8

16	Synchronous	Stimulation of both channels occurs synchronously. The "ON" time including "Ramp Up" and "Ramp Down" time. Therefore, the setting of ON Time should be no less than two times of the "Ramp" time in this mode. ON TIME Ramp up + Ramp down
17	Alternate	The stimulation of the CH2 will occur after the 1st contraction of CH1 is completed. In this mode, the setting of ON Time should be no less than two times of the "Ramp" time. The OFF Time should be equal or more than the ON Time. ON TIME Ramp up + Ramp down OFFTIME ONTIME
18	Compliance Meter	This unit can store 60 sets of operation records. Total recorded time is 999 hours.
19	Low Battery Indicator	A low battery indicator will show up on the LCD when battery is low.
20	Operating Condition	Temperature:0°~40°C Relative Humidity:30%~75% Atmosphere Pressure : 700Hpa~1060Hpa
21	Tolerance	There may be a +/-5% tolerance of all settings and +/- 20% tolerance of output of intensity.

9

Chapter 9: REPLACEABLE PARTS

The replaceable parts and accessories of EMS 7500 devices are as given below:

Except leads, electrodes, battery and battery case cover, please do not try to replace the other parts of a device.

	PARTS
01	LEAD WIRES
02	ELECTRODES
03	9V BATTERY ,TYPE 6F22
04	BELTCLIP
05	BATTERY CASE COVER
06	LEADCONNECTOR
07	MAIN PCB
08	INTENSITY KNOB
09	LCD COVER
10	INTENSITY CONTROL COVER

Chapter 10: ACCESSORIES

Each EMS 7500 comes complete with standard accessories and the standard labels as given below:

I. Accessories

REF. NO.	PRODUCT	QTY
EF1515TC2	40 X40 mm Adhesive Electrodes	4 pieces
WW3005	Electrodes Leads	2 pieces
TA9050	9 V Battery	1 piece
	Instruction Manual	1 piece
	Carrying Case	1 piece

10

II. LABEL



The label attached to the back of device contains important information about this device- model, supply voltage and caution.

Please do not remove.

Chapter 11: GRAPHIC SYMBOLS

- Degree of Electrical Protection BF
- Do not insert the plug into AC power supply socket
- Direct Current (DC power source)
- Timer
- Low Battery
- Increment
- Decrement

Chapter 12: OPERATING INSTRUCTIONS

- Insert the 9V battery into the EMS 7500's battery compartment. Make sure to remove the plastic seal on the 9V battery. Line up the positive and negative terminals on the battery with their corresponding terminals in the EMS 7500. Make sure that both Intensity control (ON/OFF Switch) knobs are in the off position.
- Insert the lead wires into the lead wire sockets on top of the EMS 7500.
- Open the electrode package. Then insert each lead wire pin into the pig tail of the electrodes.

11

- 4) Place the electrode on your body as directed by your physician.
- 5) Slowly turn on the EMS 7500 by rotating the Intensity control (ON/OFF Switch) knobs.
- 6) Select the mode and settings as directed by your physician.
- 7) Slowly increase or decrease the intensity as directed by your physician by rotating the Intensity control (ON/OFF Switch) clockwise to increase, counter clockwise to decrease.
After Treatment, Turn the EMS 7500 off by rotating the Intensity control (ON/OFF Switch) counter clockwise to the zero setting.

Chapter 13: ATTACHMENT OF ELECTRODE LEAD WIRES

The wires provided with the system insert into the jack sockets located on top of the device. Holding the insulated portion of the connector, push the plug end of the wire into one of the jacks (see drawing); one or two sets of wires may be used.

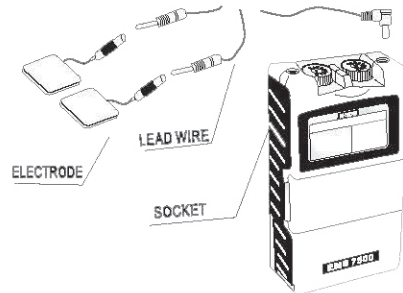

After connecting the wires to the stimulator, attach each wire to an electrode. Use care when you plug and unplug the wires. Jerking the wire instead of holding the insulated connector body may cause wire breakage.

12

CAUTION

Do not insert the plug of the patient lead wire into the AC power supply socket.

Chapter 14: LEAD WIRE MAINTENANCE

Clean the wires by wiping with a damp cloth. Coating them lightly with talcum powder will reduce tangling and prolong life.

Chapter 15: ELECTRODE OPTIONS

The electrodes are disposable and should be routinely replaced when they start to lose their adhesive nature. If you are unsure of your electrode adhesive properties, order replacement electrodes. Replacement electrodes should be re-ordered through or on the advice of your physician to ensure proper quality. Follow application procedures outlined in electrode packing, to maintain optimal stimulation and to prevent skin irritation. The device is completed with standard carbon film adhesive electrodes in size 4x4cm.

Chapter 16: ELECTRODE PLACEMENT

The placement of electrodes can be one of the most important parameters in achieving success with EMS therapy. Of utmost importance is the willingness of the physician to try the various styles of electrode placement to find which method best fits the needs of the individual patient.

Every patient responds to electrical stimulation differently and their needs may vary from the conventional settings suggested here. If the initial results are not positive, speak to your physician about alternative stimulation settings and/or electrode placements. Once an acceptable placement has been achieved, mark down the electrodes sites and the settings, so the patient can easily continue treatment at home.

13

Chapter 17: TIPS FOR SKIN CARE

To avoid skin irritation, especially if you have sensitive skin, follow these suggestions:

1. Wash the area of skin where you will be placing the electrodes, using mild soap and water before applying electrodes, and after taking them off. Be sure to rinse soap off thoroughly and dry skin well.
2. Excess hair may be clipped with scissors; do not shave stimulation area.
3. Wipe the area with the skin preparation your clinician has recommended. Let this dry. Apply electrodes as directed.
4. Many skin problems arise from the "pulling stress" from adhesive patches that are excessively stretched across the skin during application. To prevent this, apply electrodes from centre outward; avoid stretching over the skin.
5. To minimize "pulling stress", tape extra lengths of lead wires to the skin in a loop to prevent tugging on electrodes.
6. When removing electrodes, always remove by pulling in the direction of hair growth.
7. It may be helpful to rub skin lotion on electrode placement area when not wearing electrodes.
8. Never apply electrodes over irritated or broken skin.

14

Chapter 18: APPLICATION OF RE-USABLE SELF ADHESIVE ELECTRODES

Application

1. Clean and dry the skin at the prescribed area thoroughly with soap and water prior to application of electrodes.
2. Insert the lead wire into the pin connector on the pre-wired electrodes.
3. Remove the electrodes from the protective liner and apply the electrodes firmly to the treatment site. Make sure that the unit is turned off prior to applying the electrodes.

Removal

1. Turn off the unit prior to removing the electrodes.
2. Lift at the edge of electrodes and peel; do not pull on the lead wires because it may damage the electrodes.
3. Place the electrodes on the liner and remove the lead wire by twisting and pulling at the same time.

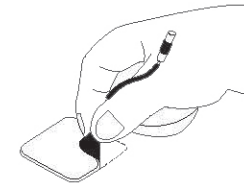

Care and Storage

1. Between uses, store the electrodes in the resealable bag in a cool dry place.
2. It may be helpful to improve repeated application by spreading a few drops of cold water over the adhesive and turn the surface up to air dry. Over Saturation with water will reduce the adhesive properties.

15

Important

1. Do not apply to broken skin.
2. The electrodes should be discarded when they are no longer adhering.
3. The electrodes are intended for single patient use only.
4. If irritation occurs, discontinue use and consult your clinician.
5. Read the instructions for use of self-adhesive electrodes before application.

Chapter 19: ADJUSTING THE CONTROLS

1. Panel Cover:
A lid covers the controls for selecting mode and adjusting settings. Your medical professional may wish to set these controls for you and request that you leave the cover in place.

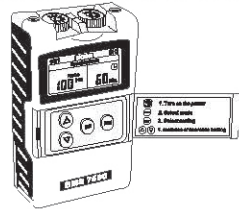

2. Power On/Off Switch and Intensity Controls:
If both controls are in the off-position, the device is switched off. By turning the controls clockwise, the appropriate channel is switched on and the indicator of power (CH1 or CH2) will reveal on the LCD.

The current strength of the impulses transmitted to the electrodes increases further when the control is turned clockwise. To reduce the current strength or switch the device off, turn the control counter clockwise to the required setting or off-position, respectively. The controls are protected by a cap to avoid unintentional change of intensity.

16

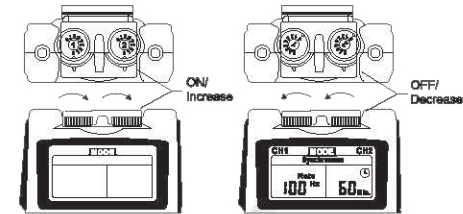

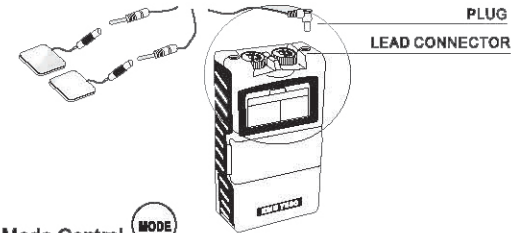

3. Lead Connector
Connection of the electrodes is made with the two lead wires. The device must be switched off before connecting the cables. Both intensity controls must be at the Off-position. Electrodes must be pressed firmly on the skin.



4. Mode Control (MODE)
There are 3 modes available – Constant, Synchronous and Alternate. A mode can be selected by pressing the "Mode" control.
5. Set Control (SET)
By pressing the "SET" control, you may enter the setting you intend to make adjustment. You may start to set the value by pressing the "Increment" and "Decrement" controls when the value is flashing.
6. Increment Control (Δ)
This button controls the increase of settings. When pressing this button, the parameter will increase.

17

7. **Decrement Control** 
 This button controls the decrease of parameter. When pressing this button, the parameter will decrease.
8. **Timer** 
 The unit has a timer of 1-60 minutes and Continue. It can be adjusted by pressing the "Set" and "Increment" or "Decrement" controls. The treatment time will countdown in one minute decrement. Its output will be shut off when time is up.
9. **Low Battery Indicator** 
 A low battery indicator will show up on the liquid crystal display when the battery need to be replaced as soon as possible. It may continue to operate for a few more hours depends on the setting intensity level.
10. **Steps to Set a New Program**
 The settings can be adjusted according to the following steps.

- a. **Turn on the Intensity**
 After the electrodes are placed firmly on skin and the lead wires are plugged in the socket of device, turn the on/off control clockwise. The liquid crystal display will light up.
- b. **Select Mode**
 Select a mode by pressing the "Mode" control. The mode you selected will show up on the top of liquid crystal display. When "Constant" mode is selected, you can set only pulse width, pulse rate and timer later on. All parameters are adjustable on the Synchronous and Alternate mode. After a mode is selected, press "SET" control to enter next setting. You may adjust the setting only when the value is flashing. Then press the "Increment" or "Decrement" control to change the settings.

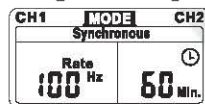

18

- c. **Set Ramp Time**
 The ramp time controls the time of output current that increase from 0 to the setting level, and from the setting value to 0. When the ramp time is set, each contraction may be ramped up and down in order that the signals come on and come off gradually and smoothly. The ramp time is adjustable from 1 to 8 seconds.

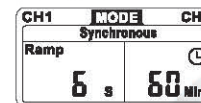

- d. **Set On Time**
 The On Time controls the time of stimulation. By pressing the "SET" control, the contraction time can be adjusted. Both channels' stimulation is cycled on and off by the contraction and relaxation settings. The range is adjustable from 2 to 90 seconds.
- As the "ON" time including the ramp up and ramp down time, the setting of it should be no less than two times of the "Ramp" time. (ON TIME Ramp up + Ramp down)

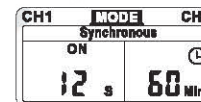

- e. **Set Off Time**
 The Off Time controls the time of relaxation. By pressing the "SET" control, the relaxation time can be adjusted. Both channels' stimulation is cycled on and off by the contraction and relaxation settings. The range is adjustable from 0 to 90 seconds.
- In Alternate mode, the OFF Time should be equal or more than the ON Time. (OFF TIME ON TIME)

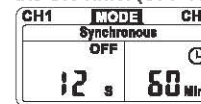

19

f. Set Pulse Width

The pulse width determines the length of time. Each electrical signal is applied through the skin, which controls the strength and sensation of the stimulation. Press "SET" control to enter this setting. The pulse width is adjustable from 50 to 300 μ s.

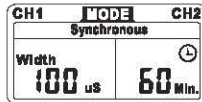

g. Set Pulse Rate

The pulse rate determines how many electrical impulses are applied through the skin each second. Press "SET" to enter this menu. By pressing the increment and decrement controls, the setting can be adjusted. The pulse rate is adjustable from 2 Hz to 150 Hz.

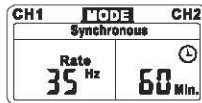

h. Set Timer

Press "SET" to enter this setting. The treatment time is adjustable from 1 to 60 minutes or Continuous. It is increased in 1 minute each step from 1 to 15 minutes and 5 minutes each step from 15 to 60 minutes. Press "Increment" or "Decrement" control to adjust setting. Your settings will be stored in this unit eternally unless they are adjusted again.

You can set the timer to "Continuous" mode by pressing the "Increment" control when it shows 60 minutes.

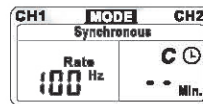

Continuous

20

11. Patient Compliance Meter

This unit can store 60 sets of operation records. Total treatment time up to 999 hours can be stored.

Check & Delete Individual Records

Press "Mode" control and turn on the power simultaneously. The LCD will show the number of records and operation time. Press the "Increment" and "Decrement" button to check each record. To delete a record, press "SET" control for 3 seconds.

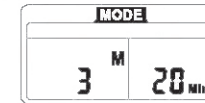
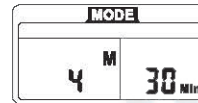

Check & Delete Accumulative Record

At the individual records menu, press "Mode" control to switch to accumulative record menu. Press the "SET" control first, then press the "Mode" control simultaneously for 3 seconds and all of the records will be deleted followed by a beeper sound.

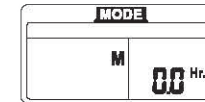
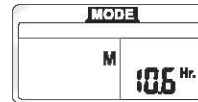

12. Check/Replace the Battery:

Over time, in order to ensure the functional safety of the EMS 7500, changing the battery is necessary.

1. Make sure that both intensity controls are switched to off- position.
2. Slide the battery compartment cover and remove.
3. Remove the battery from the compartment.
4. Insert the battery into the compartment.
5. Note the polarity indicated on the battery and in the compartment.
6. Replace the battery compartment cover and slide to close

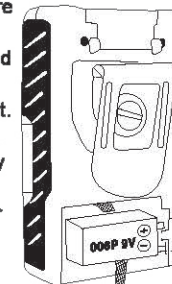

21

Chapter 20: BATTERY INFORMATION

PRECAUTIONS

1. Remove battery if equipment is not likely to be used for some time.
2. Please recycle the used battery in accordance with domestic regulation.
3. Do not throw the used battery into fire.

If you use rechargeable batteries, please follow the instructions.

RECHARGEABLE BATTERIES (NOT INCLUDED)

Prior to the use of a new unit, the rechargeable battery should be charged according to the battery manufacturer's instructions. Before using the battery charger, read all instructions and cautionary markings on the battery and in this instruction manual.

After being stored for 60 days or more, the batteries may lose their charge. After long periods of storage, batteries should be charged prior to use.

BATTERY CHARGING

- (1) Plug the charger into any working 110 or 220/240v mains electrical outlet. The use of any attachment not supplied with the charger may result in the risk of fire, electric shock, or injury to persons.
- (2) Follow the battery manufacturer's instructions for charging time.
- (3) After the battery manufacturer's recommended charging time has been completed, unplug the charger and remove the battery.
- (4) Batteries should always be stored in a fully charged state.
To ensure optimum battery performance, follow these guidelines:
 - (a) Although overcharging the batteries for up to 24 hours will not damage them, repeated overcharging may decrease useful battery life.
 - (b) Always store batteries in their charged condition. After a

battery has been discharged, recharge it as soon as possible. If the battery is stored more than 60 days, it may need to be recharged.

- (c) Do not short the terminals of the battery. This will cause the battery to get hot and can cause permanent damage. Avoid storing the batteries in your pocket or purse where the terminals may accidentally come into contact with coins, keys or any metal objects.
- (d) WARNINGS:
 1. Do not attempt to charge any other types of batteries in your charger, other than rechargeable batteries made for your charger. Other types of batteries may leak or burst.
 2. Do not incinerate the rechargeable battery as it may explode!

Chapter 21: MAINTENANCE, TRANSPORTATION AND STORAGE

1. Non-flammable cleaning solution is suitable for cleaning the device.
Note: Do not smoke or work with open lights (for example, candles, etc.) when working with flammable liquids.
2. Stains and spots can be removed with a cleaning agent.
3. Do not submerge the device in liquids or expose it to large amounts of water.
4. Return the device to the carrying box with sponge foam to ensure that the unit is well-protected before transportation.
5. If the device is not to be used for a long period of time, remove the batteries from the battery compartment (acid may leak from used batteries and damage the device). Put the device and accessories in carrying box and keep it in cool dry place.
6. The packed EMS 7500 device should be stored and transported under the temperature range of -20°C ~ + 60°C, relative humidity 20% ~ 95% Atmosphere pressure 500hPa-1060hPa.

Chapter 22: SAFETY-TECHNICAL CONTROLS

For safety reasons, check your EMS 7500 each week based on the following checklist.

1. Check the device for external damage.
 - deformation of the housing.
 - damaged or defective output sockets.
2. Check the device for defective operating elements.
 - legibility of inscriptions and labels.
 - make sure the inscriptions and labels are not distorted.
3. Check LCD
 - Mode and all parameters must be visible on the LCD.
4. Check the usability of accessories.
 - patient cable undamaged.
 - electrodes undamaged.

Please consult your distributor if there are any problems EMS with device and accessories.

Chapter 23: MALFUNCTIONS

- Should any malfunctions occur while using the EMS 7500, check
- whether the controls or parameters are set to the appropriate form of therapy. Adjust the control correctly.
 - whether the cable is correctly connected to the device. The cables should be inserted completely into the sockets.
 - whether the LCD reveals the menu. If necessary, insert a new battery.
 - for possible damage to the cable. Change the cable if any damage is detected.

* If there is any other problem, please return the device to your distributor. Do not try to repair a defective device.

24

Chapter 24: CONFORMITY TO SAFETY STANDARDS

The EMS 7500 devices are in compliance with the EN 60601-1-2:2007 and EN 60601-1:1990+A1:1993+A2:1995 safety standards.

Chapter 25: WARRANTY

All EMS 7500 models carry a warranty of three years from the date of delivery. The warranty applies to the stimulator only and covers both parts and labor relating thereto.

The warranty does not apply to damage resulting from failure to follow the operating instructions, accidents, abuse, alteration or disassembly by unauthorized personnel.

25

V 1.1



EMS7500.ai 2010/3/22 下午 03:09:33



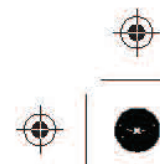
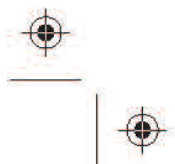
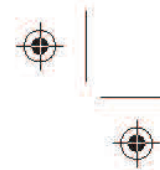
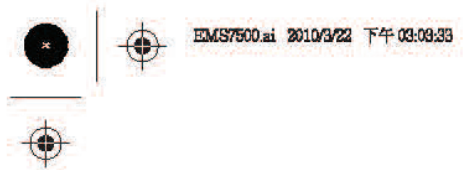



EMS7500.ai 2010/3/22 下午 03:09:33





EMS7500.ai 2010/3/22 下午 03:09:33

