



# HUMAC<sup>®</sup> NORM<sup>®</sup>

TESTING & REHABILITATION SYSTEM

*Measure & Improve  
Performance*



## Unparalleled Software and Mechanical Design

CSMi is proud to introduce the new HUMAC NORM Testing & Rehabilitation System. With the acquisition of CYBEX Medical, CSMi is now able to offer in one machine the industry-leading HUMAC Software coupled with the proven mechanical design of the CYBEX NORM.



*CSMi has earned a worldwide reputation as an industry innovator and provider of quality, customer oriented products. I am pleased the CYBEX Medical products are now under their stewardship.*

**Dave Hillery**  
 President of CYBEX Division of Lumex  
 1970-1990

## Table of Contents

History .....	2-3
Solutions .....	4-5
Defined .....	6-7
Patterns .....	8-9
Options .....	10-11

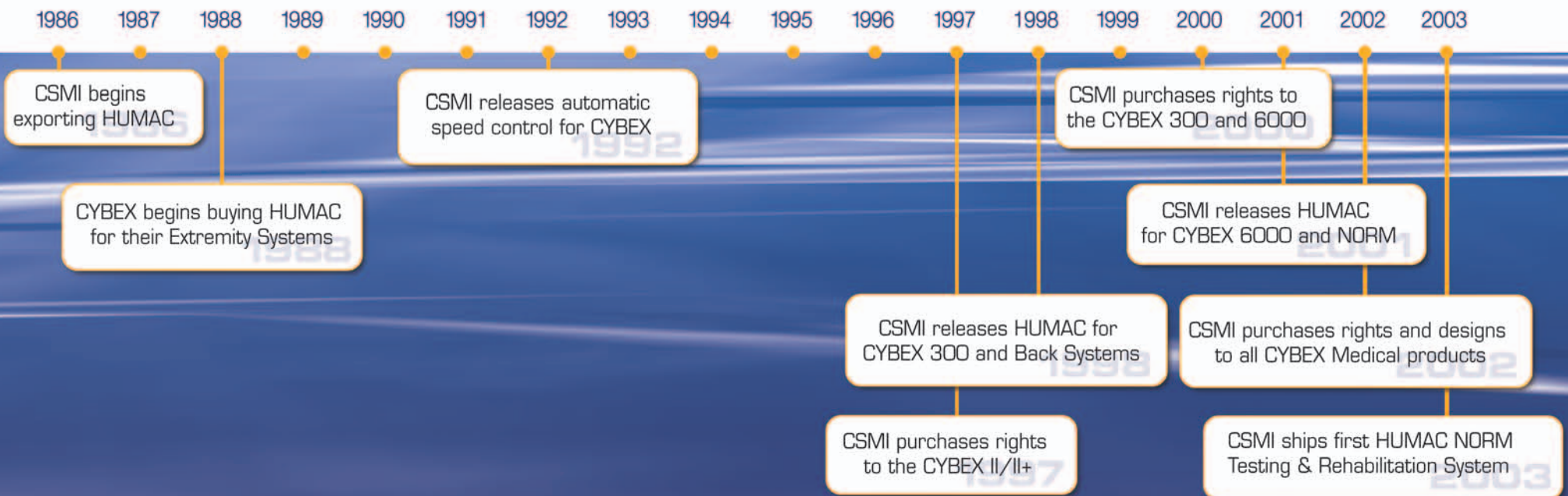



# HUMAC<sup>®</sup> NORM<sup>®</sup> Solutions

## TESTING & REHABILITATION SYSTEM

The HUMAC NORM is your solution for measuring and improving human performance in the clinic, training room, and research laboratory. In one machine the HUMAC NORM offers 22 isolated-joint movement patterns, four resistance modes (isokinetic, isotonic, isometric, and passive) and numerous reports to meet the measurement and exercise needs of today's clinicians and researchers.



### Measurement

Only with testing can you determine baselines, set goals, and track change. The HUMAC NORM offers two primary measurement solutions.

- **Isometric Testing:** when dynamic movement is a concern, isometric testing is the answer. The HUMAC NORM will safely position the patient to each angle in the protocol. Protocol options include angles, hold-times, rest periods, repetitions, and sets.
- **Isokinetic Testing:** to determine maximum dynamic capability throughout the range-of-motion isokinetic testing is the solution. The HUMAC NORM offers concentric and eccentric resistance testing. Isokinetic curve results make it easy determine areas of pain or weakness and determine capability.

### Exercise

Exercise is performed to improve mobility, stability, strength, and control. The HUMAC NORM offers four modes of resistance and numerous feedback options to meet these goals.

- **Passive Mode:** develop the mobility that the patient requires, from straight pattern movements to complex PNF patterns.
- **Isometric Mode:** stabilize the joint to perform angle-specific strength training.
- **Isokinetic Mode:** continue to strengthen using proven methods to enhance return-to-function including concentric and eccentric loading and deceleration training.
- **Isotonic Mode:** complete the return-to-function training using our simulated mass isotonic mode.



The HUMAC NORM Testing & Rehabilitation System is the one machine that fulfills the testing and exercise needs of today's clinicians and researchers. The HUMAC Software makes it easy to operate.

## Software

The HUMAC Software was designed with one goal in mind – enable the user to go from patient setup to report in hand as quickly as possible. Time is a limited commodity in every setting. This is why we chose Windows XP styling for the HUMAC Software. It is immediately recognizable to all users, so learning and operating the HUMAC NORM is a snap.

## Intuitive Steps

To perform a test or exercise simply select patient, pattern, protocol and you are ready to start the session. The next time the patient is on the HUMAC NORM the process is even faster. Select QuickTest or QuickEx to go directly from patient selection to session. The HUMAC automatically applies test or exercise protocol used from the most recent session.

## Personalize Your Preferences

The HUMAC's Preference settings give you the flexibility to customize the software to your specific needs. Preference options include Feedback, Data Analysis, and Reporting.

## Your Software is Never Obsolete

CSMi continues to develop the HUMAC Software. And we always make sure the HUMAC Software is backwards compatible with all of our machines. From the earliest CYBEX II to the latest HUMAC NORM, your investment is never obsolete.

Visit [www.csmisolutions.com](http://www.csmisolutions.com) to see sample HUMAC screens.

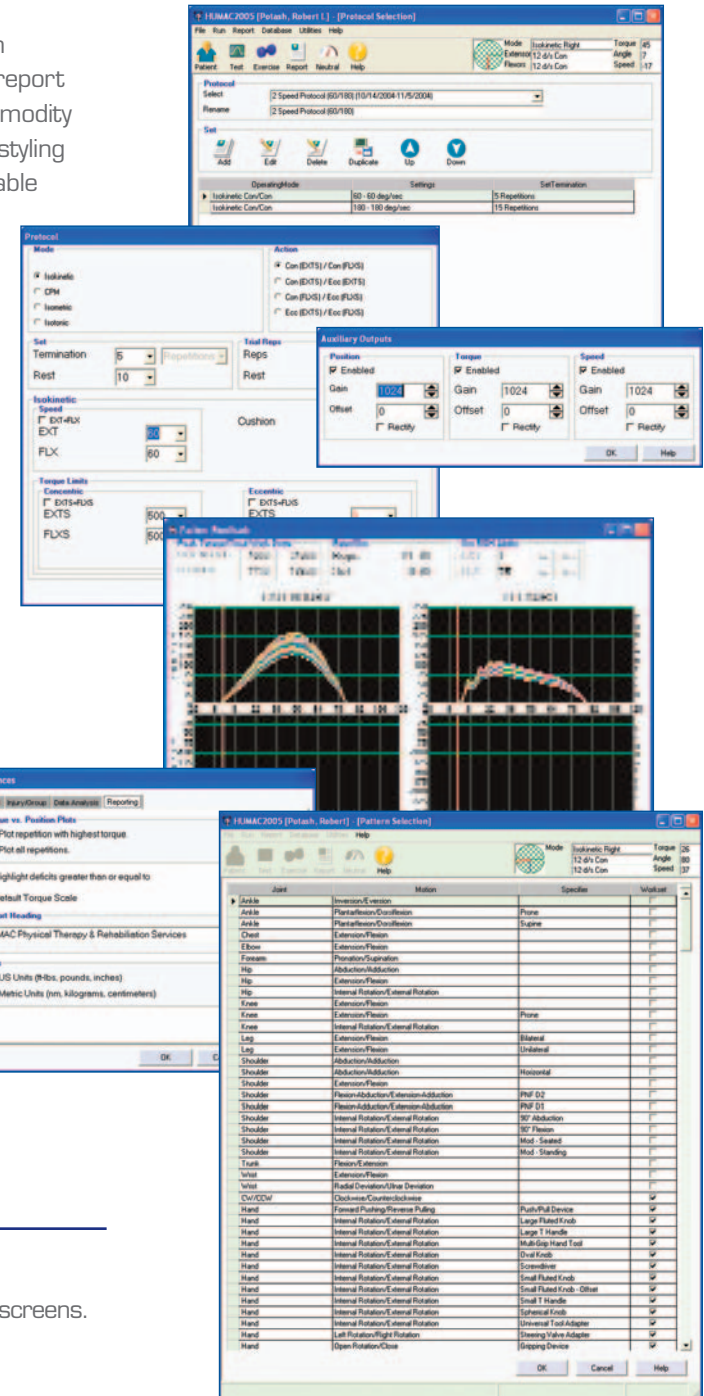

# HUMAC<sup>®</sup> NORM<sup>®</sup>

TESTING & REHABILITATION SYSTEM

## Defined

### SECURE PATIENT POSITIONING

The HUMAC NORM seat area is 1,220 square inches. The large seat, coupled with fore/aft seat back positioning and a four point seatbelt harness, accommodates and stabilizes small and big, young and old patients alike.

### MOVABLE CHAIR - FIXED DYNAMOMETER

The patented dynamometer/seat configuration minimizes floor space and adjustments, and insures quick and secure patient set-ups.

### LOCKING CLAMPS

The locking clamps secure the dynamometer and seat in place. This design offers infinite positioning options and unmatched rigidity and durability. Dual clamps allow adjustments from either side of the machine.

### CONTINUOUS ROTATION

The dynashaft allows continuous 360° rotation to simulate work patterns such as turning a wheel or screwdriver.

### ADJUSTABLE RANGE-OF-MOTION STOPS

With the Adjustable Range-of-Motion Stops you do not have to change adapters each time you change sides.

### MAXIMUM RESISTANCE

The HUMAC NORM dynamometer offers 500 ft-lbs. of eccentric and concentric force.





## INTUITIVE USER INTERFACE

Our easy-to-use HUMAC software creates a machine everyone can operate.

## CONTEXT-SENSITIVE HELP SYSTEM

Each HUMAC NORM window includes a Help button. Simply press Help and the on-line Help System opens to the very page you are on in the software.

## INTEGRATED COMPUTER SYSTEM

The integrated computer system design saves floor space, reduces cables, and guarantees the keyboard and monitor will always be within reach.

## AUXILIARY OUTPUTS (AO)

The auxiliary outputs provide easy access to torque, position, and velocity analog signals for input into other systems such as EMG. Our AO Software Control Window lets you adjust the Gain and Offset and rectify the signals to your requirements.

## HUMAC Reports

The HUMAC offers a variety of easy-to-read, easy-to-interpret reports. Full-page reports are in color and can be printed, previewed, or e-mailed. Raw data is automatically saved for export to Excel or other formats.

### HUMAC Reports Options Include:

- Test
- Curve Overlay
- Graphic Summary
- Exercise
- Narrative
- Repeatability
- Progress
- Group Summary
- Multi-Session
- Normative Data

### Default Deficits and Exploded View

Deficits are automatically highlighted if they exceed the default value. Individual repetition values can be seen by clicking Zoom while previewing a test.

### Preference Override

The HUMAC Report Preferences such as average vs. best rep; default deficit values; metric vs. US units, are applied to every report. Preference Override lets you change any setting immediately before printing a report.

### Normative Data 20,000 Tests Strong

The HUMAC includes a database of 20,000 normal Knee and Shoulder test results. This allows you to compare your test results to one of the largest isokinetic normative data databases in the world.

Visit [www.csmisolutions.com](http://www.csmisolutions.com) to see sample HUMAC Reports.

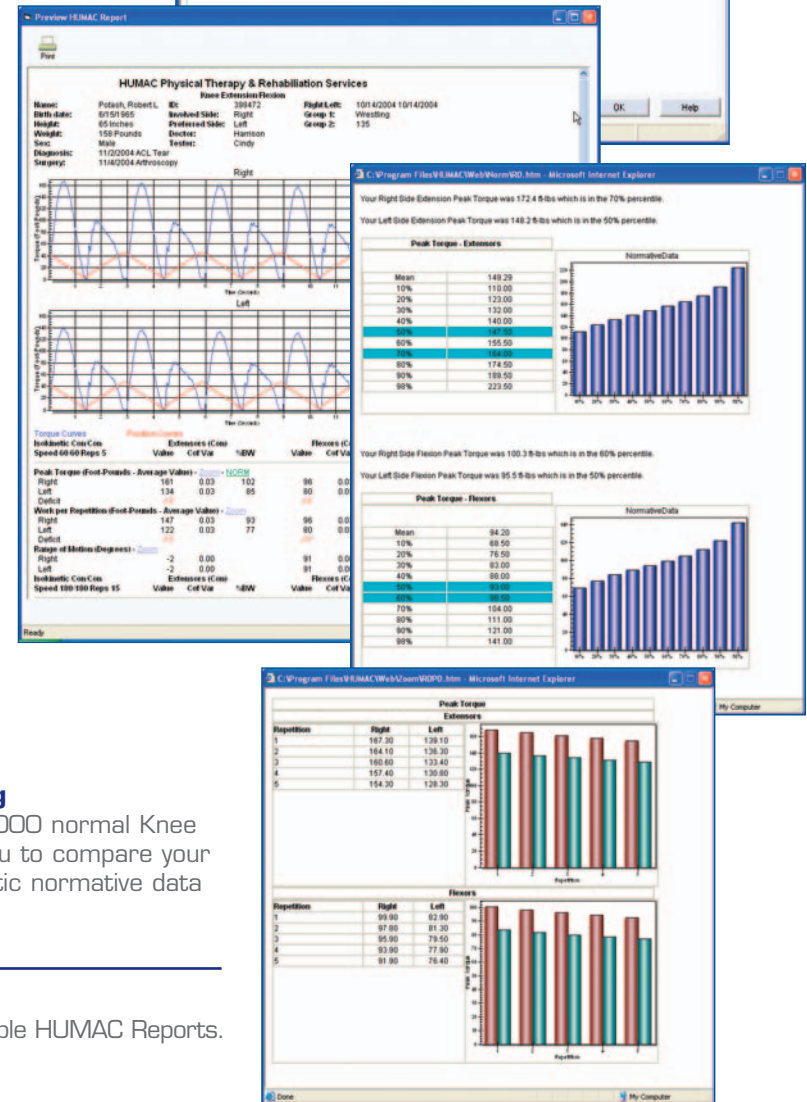
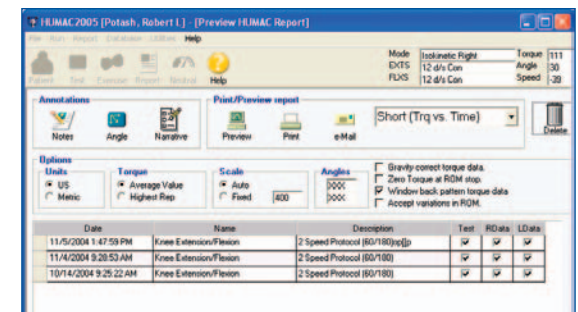

# HUMAC<sup>®</sup> NORM<sup>®</sup> Patterns

## TESTING & REHABILITATION SYSTEM

The HUMAC NORM includes attachments to perform 22 isolated patterns covering the shoulder, elbow, wrist, hip, knee, ankle and back. Optional attachments allow trunk extension/flexion, work simulation, and closed kinetic chain patterns.

**Knee: Extension/Flexion Seated**

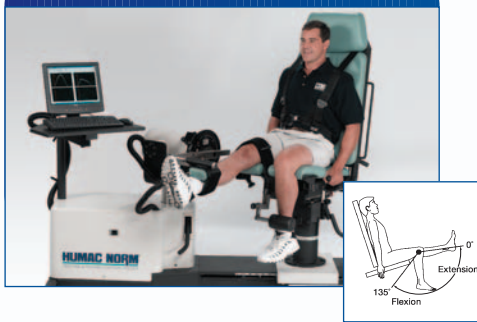

**Knee: Extension/Flexion Prone**



**Knee: Tibial Internal/External Rotation**



**Shoulder: Extension/Flexion**



**Shoulder: Horizontal Abduction/Adduction**



**Shoulder: Internal/External Rotation in 90° Abduction**



**Shoulder: Internal/External Rotation, Mid-Standing**



**Forearm: Pronation/Supination**

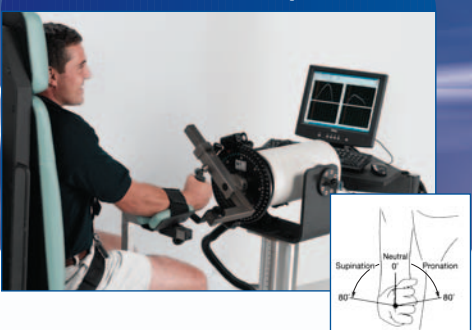

**Wrist: Extension/Flexion**



**Wrist: Radial/Ulnar Deviation**



**Elbow: Extension/Flexion**





**Ankle: Plantar/Dorsiflexion Prone**

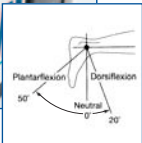

**Ankle: Plantar/Dorsiflexion Supine**

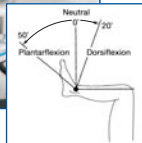

**Ankle: Inversion/Eversion**

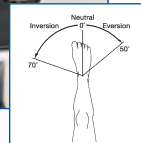

**Shoulder: Abduction/Adduction**

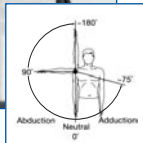

**Shoulder: Internal/External Rotation, Mod-Seated**

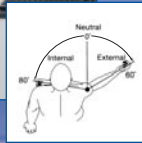

**Shoulder: Internal/External Rotation in 90° Flexion**

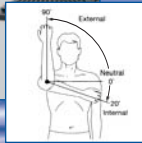

**PNF D1: Flexion-Adduction/Extension-Abduction**

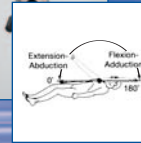

**PNF D2: Flexion-Adduction/Extension-Adduction**

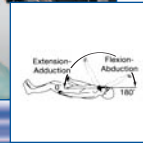

**Hip: Abduction/Adduction**

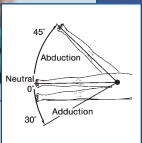

**Hip: Flexion/Extension**

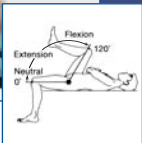

**Hip: Internal/External Rotation**

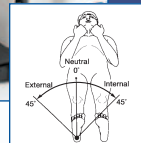

**Trunk: Flexion/Extension**

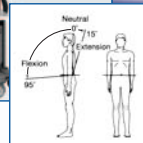

## Options

### Trunk Modular Component (TMC)

With the TMC the HUMAC NORM is perfectly suited for trunk testing and rehabilitation in a fully functional, standing position. The motorized footplate ensures accurate patient positioning. The low inertia input assembly and lightweight attachment enables patients to begin rehabilitation sooner.

### Johnson Anti-Shear™ Accessory

The Johnson Anti-Shear Dual Pad Accessory with adjustable fulcrum allows the clinician to select the correct amount of counterforce necessary to control anterior shear during knee extension. This prevents excessive stress on repairs, healing, or chronically lax ligaments.

### Work Simulation Package

The Work Simulation Package allows clinicians to simulate an unlimited number of real-life and occupational patterns. The attachments include an assortment of handles and knobs, a steering device, a gripping device, and a push/pull device. Because the HUMAC NORM's dynamometer shaft allows full 360° rotation you enjoy a greater range of exercise options.

### Closed Kinetic Chain (CKC) Accessory

The CKC expands the HUMAC NORM from a rotary device to a linear device. Use the rugged CKC to test and exercise patients in linear, closed chain patterns. The CKC includes attachments to perform a single and bilateral leg press, and bilateral chest press.

### COLOR COORDINATED

The HUMAC NORM standard colors include a white plastic shroud and a black frame with teal upholstery. If your color needs are different we invite you to select the color shroud (white or black), frame, and upholstery that match your facility. We can embroider your logo into the seat back. Custom colors and embroidery requests slightly increase final price and delivery time.



Trunk Modular Component (TMC)



Johnson Anti-Shear™ Accessory



Work Simulation Package



Closed Kinetic Chain (CKC) Accessory

## Resistance Modes

### Mode

Isokinetic Concentric  
Isokinetic Eccentric  
CPM  
Isometric  
Isotonic

### Speeds

$\frac{1}{16}$  - 500<sup>o</sup> per sec  
 $\frac{1}{16}$  - 300<sup>o</sup> per sec  
 $\frac{1}{16}$  - 150<sup>o</sup> per sec

### Torque

500 ft-lbs/678 Nm  
500 ft-lbs/678 Nm  
500 ft-lbs/678 Nm  
500 ft-lbs/678 Nm  
500 ft-lbs/678 Nm

## Suggested Floor Plan

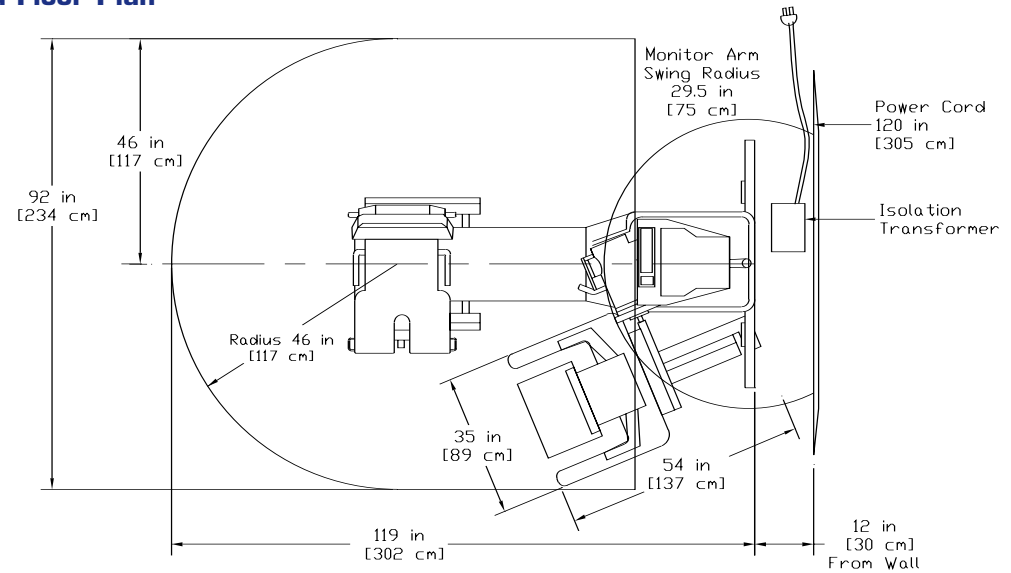

## Electrical Specifications

Independent 20 Amp single phase line. Can be configured for input voltages between 184 and 259 VAC. Shipped configured for 208 VAC. Recommended outlet receptacle NEMA 6-20R (Hospital Grade)

## Power Requirements

Input Voltage: 220 VAC (other voltages available)  
Input Frequency: 60Hz (international frequency 50Hz available)  
Independent 20 amp dedicated circuit required

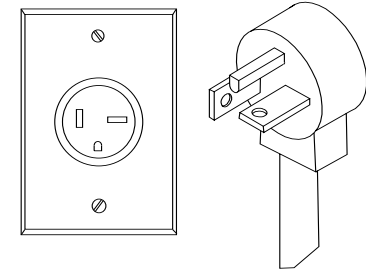

Black shroud w/ gray frame.



White shroud w/ black frame.

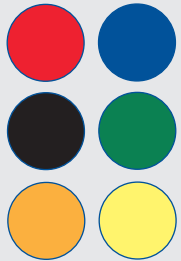

Upholstery is available in color combinations to match your team or facility.

Visit [www.csmisolutions.com](http://www.csmisolutions.com) to learn more about HUMAC options.



- PT Clinic Website Design Tool
- PVI Home Exercise Software
- SportsWare™ Injury Tracking Software
- HUMAC Computer System Upgrade for CYBEX Extremity Systems
- Service and Support for CYBEX II/II+, 300 Series, Back Series, 6000, and NORM
- New HUMAC NORM Single Chair Extremity System
- Balance System
- Kinetron Lower Extremity Rehabilitation System

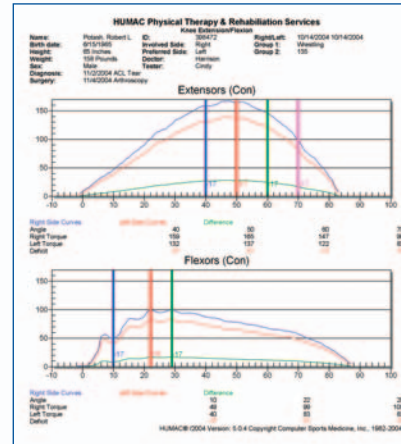

**HUMAC Physical Therapy & Rehabilitation**

Monday, November 15, 2004

Report on: Potash, Robert L.

Dear Dr. Harrison:

Thank you for referring Robert Potash for HUMAC/NORM isometric testing. The Patient has a diagnosis of ACL Tear.

The following graphs show the force curves of the Right vs. the Left superimposed, showing a comparative picture of the individual's ability to produce force throughout the ROM.

In normal subjects, imbalances of 10% or less can be considered normal while differences of 10% to 20% possibly abnormal and those 20% and above probably abnormal.\* The patient produced the following torques:

Muscle	Right	Left	Deficit
Extensors	161.00	134.00	-17%
Flexors	55.00	83.00	-17%

The patient would benefit from physical therapy to improve strength. My treatment plan will include isolated and functional strength training. If you have any comments or suggestions concerning this patient, contact me directly at 781-297-2034.

Sincerely,  
**Richard Collins**  
 Richard Collins

\*Muscle Performance (Evaluation in Orthopedic Practice), Alexander A. Stepp, MD. *Journal of Bone and Joint Surgery*, Vol 72A, Issue 10, Dec 1990.

www.csmisolutions.com info@csmisolutions.com  
 101 Tosca Drive Stoughton, MA 02072 Voice: (508) 297-2034 FAX: (781) 297-2039

