

# DRAG PIPE SETS FOR 1979 SPORTSTERS



**720A**  
**34"-LONG**  
**GOOSE CUT**  
**DRAG PIPES**

## 1 3/4" DRAG PIPE SETS FOR 1979 SPORTSTERS

These drag pipe sets will not fit with a kickstart. Use Paughco #725A clamps to attach these pipe sets to the exhaust ports. Heat shields are highly recommended.

**720A** 34"-long Goose Cut drag pipes (use Paughco #725D clamps to install)

**720** 34"-long Slash Cut drag pipes (use Paughco #725D clamps to install)

**720-40** 40"-long Slash Cut drag pipes with slider channels (use a Paughco #718 hanger bracket to install)

**419F** Front heat shield for Paughco #720 series pipe sets (not shown)

**420R** Rear heat shield for Paughco #720 series pipe sets (not shown)

**718** Hanger bracket for Paughco #720-40 pipe set



**720**  
**34"-LONG**  
**SLASH CUT**  
**DRAG PIPES**

### SPECIAL NOTES:

- 1) DRAG PIPES ARE NOT RECOMMENDED FOR USE ON THE STREET.
- 2) SEE PAGE 247 FOR CLAMPS TO INSTALL THESE PIPE SETS.
- 3) SEE PAGES 349-353 FOR PHOTOS OF THE HEAT SHIELDS FOR THESE PIPE SETS.

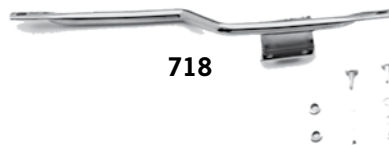

**718**



**720-40**  
**40"-LONG**  
**SLASH CUT**  
**DRAG PIPES**



# STAGGERED DUALS FOR 1979 SPORTSTERS

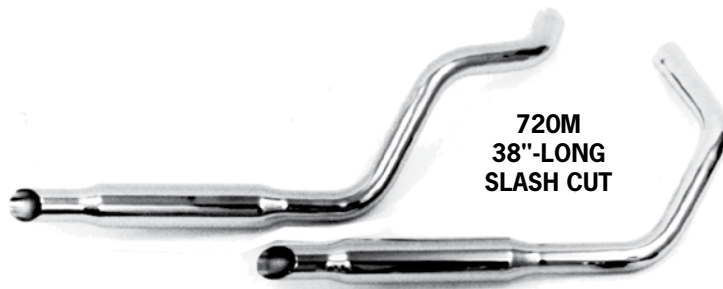

**720M  
38\"/>**



TRIKE  
KITS

SPRINGERS  
& FORKS

HANDLEBARS  
& RISERS

LIGHTING

FRAMES &  
ACCESSORIES

WHEELS  
& BRAKES

GAS & OIL  
TANKS

SHEET  
METAL

ENGINE &  
ELECTRICAL

PRIMARY &  
DRIVETRAIN

FOOT  
CONTROLS

TRANSMISSION

EXHAUST

TOOLS &  
GENERAL



**718**

**720GM  
38\"/>**

## 1 3/4" STAGGERED DUAL PIPE SETS FOR 1979 SPORTSTERS

These exhaust systems for 1979 Sportsters without kickstart ONLY, have slider channels on the mufflers, and include a Paughco #718 hanger bracket to ease installation. Use Paughco #725A clamps to attach the pipes to the exhaust ports. Heat shields are recommended.

**720GM** 38"-long Goose Cut muffler set

**720M** 38"-long Slash Cut muffler set

**720-2M** 38"-long Super Slash Cuts

**720TM** 38"-long Tapered muffler set

**419F** Front heat shield for Paughco #720 series pipe sets (not shown)

**420R** Rear heat shield for Paughco #720 series pipe sets (not shown)

**718** Hanger bracket for Paughco #'s 720M, 720-2M, 720GM and 720TM pipe sets

**HEAT SHIELD PHOTOS CAN BE  
SEEN ON PAGES 349-353**



**720-2M  
38\"/>**



**720TM  
38\"/>**

**TO ORDER THESE PARTS, CALL US AT 775-246-5738  
OR TOLL FREE AT 800-423-2621**



# EXHAUST SYSTEMS FOR 1957-1985 SPORTSTERS



ADDITIONAL MUFFLER  
SETS CAN BE FOUND  
ON THE FACING PAGE

## 1 3/4" EXHAUST SYSTEMS FOR 1957-1985 SPORTSTERS

Choose from staggered dual muffler sets or 2-into-1 headpipe sets. A Paughco #725K brake pedal stop (sold separately) is required on 1980-1985 models. Use Paughco #725A clamps to attach these pipe sets to the exhaust ports. Heat shields are recommended.

### STAGGERED DUALS

These muffler sets have slider channels and mount with a Paughco #718 hanger bracket (included with set), but will not fit 1979 Sportsters.

**719GM** 38"-long Goose Cut muffler set

**719TM** 38"-long Tapered muffler set

**419F** Front heat shield for Paughco #719 series Ironhead pipes (shown on bike)

**419R** Rear heat shield for Paughco #719 series Ironhead pipes (not shown)

**718** Hanger bracket for Paughco #'s 719GM, and 719TM pipe sets

### 2-INTO-1 HEADPIPE SETS

These pipe sets will fit 1957-1985 Sportster engines in rigid or swingarm frames (except 1979 swingarm models). Complete these exhaust systems with a tailpipe extension or universal muffler.

**719C2** 2-into-1 headpipe set (includes a Paughco #718-6 hanger bracket for use with 'P' clamps) shown on bike

**719C2U** 2-into-1 Upsweep headpipe set (includes a Paughco #718-6S hanger strap)

**419F** Front heat shield for Paughco #719C2 series Ironhead pipe sets (shown below on bike)

**419C2R** Rear heat shield for Paughco #719C2 series Ironhead pipe sets (shown below on bike)

**718-6** Repl. hanger bracket for #719C2 pipe set

**718-6S** Repl. hanger strap for #719C2U pipe set



**719GM**  
38"-LONG  
GOOSE CUT



**718**

**719TM**  
38"-LONG  
TAPERED



**718-6**

**719C2**  
2-INTO-1  
HEADPIPES



**718-6S**

**719C2U**  
2-INTO-1  
UPSWEEP  
HEADPIPES

### SPECIAL NOTES:

- 1) DRAG PIPES ARE NOT RECOMMENDED FOR USE ON THE STREET.
- 2) SEE PAGE 247 FOR CLAMPS TO INSTALL THESE PIPE SETS.
- 3) SEE PAGES 349-353 FOR PHOTOS OF THE HEAT SHIELDS FOR THESE PIPE SETS.



**719C2 2-INTO-1 HEADPIPES  
WITH 607 FISHTAIL EXTENSION**

# STAGGERED DUALS FOR 1957-1985 SPORTSTERS

ADDITIONAL MUFFLER SETS CAN BE FOUND ON THE FACING PAGE

**719-40**  
40"-LONG SLASH CUT  
DRAG PIPES



**719A**  
34"-LONG GOOSE CUT  
DRAG PIPES



**719M**  
38"-LONG  
SLASH CUT



**718**

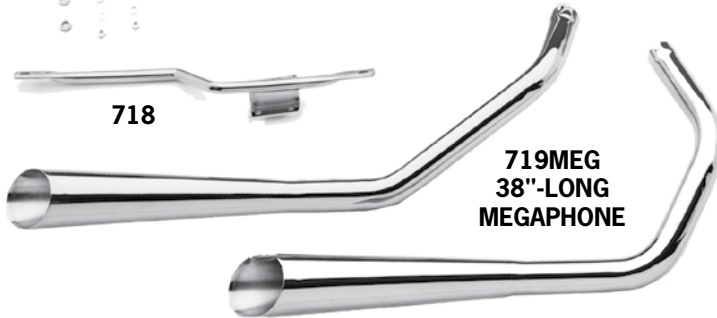

**719MEG**  
38"-LONG  
MEGAPHONE

## STAGGERED DUAL EXHAUST SYSTEMS FOR 1957-1985 SPORTSTERS

These drag pipe and muffler sets will not fit 1979 Sportsters. A Paughco #725K brake pedal stop (sold separately) is required on all 1980-1985 models. Use Paughco #725A clamps to attach the pipes to the exhaust ports. Heat shields are recommended.

### 2"-DIAMETER DRAG PIPES

**719-2IN40** 40"-long Slash Cut drag pipes (use a Paughco #718 hanger bracket to install) not shown

### 1 3/4"-DIAMETER EXHAUST SYSTEMS

**719** 34"-long Slash Cut drag pipes (use Paughco #725D clamps to install) not shown

**719A** 34"-long Goose Cut drag pipes (use Paughco #725D clamps to install)

**719-40** 40"-long Slash Cut drag pipes with slider channels (use Paughco #718 hanger bracket to install)

**719A40** 40"-long Goose Cut drag pipes with slider channels (use Paughco #718 hanger bracket to install) not shown

**719M** 38"-long Slash Cut muffler set with slider channels (includes a Paughco #718 hanger bracket)

**719-2M** 38"-long Super Slash Cut muffler set with slider channels (includes a Paughco #718 hanger bracket) shown on bike

**719MEG** 38"-long Megaphone muffler set with slider channels (includes a Paughco #718 hanger bracket)

**419F** Front heat shield for Paughco #719 series Ironhead pipe sets (shown on bike)

**419R** Rear heat shield for Paughco #719 series Ironhead pipe sets (shown on bike)

**718** Hanger bracket for Paughco #719 series pipe sets

**725K** Brake pedal stop for 1980-1985 Sportsters (not shown)

### SPECIAL NOTES:

- 1) DRAG PIPES ARE NOT RECOMMENDED FOR USE ON THE STREET.
- 2) SEE PAGE 247 FOR CLAMPS TO INSTALL THESE PIPE SETS.
- 3) SEE PAGES 349-353 FOR PHOTOS OF THE HEAT SHIELDS FOR THESE PIPE SETS.



**719-2M**  
38"-LONG SUPER SLASH CUTS

TO ORDER THESE PARTS, CALL US AT 775-246-5738  
OR TOLL FREE AT 800-423-2621



TRIKE  
KITS

SPRINGERS  
& FORKS

HANDLEBARS  
& RISERS

LIGHTING

FRAMES &  
ACCESSORIES

WHEELS  
& BRAKES

GAS & OIL  
TANKS

SHEET  
METAL

ENGINE &  
ELECTRICAL

PRIMARY &  
DRIVETRAIN

FOOT  
CONTROLS

TRANSMISSION

EXHAUST

TOOLS &  
GENERAL

TRIKE  
KITSSPRINGERS  
& FORKSHANDLEBARS  
& RISERS

LIGHTING

FRAMES &  
ACCESSORIESWHEELS  
& BRAKESGAS & OIL  
TANKSSHEET  
METALENGINE &  
ELECTRICALPRIMARY &  
DRIVETRAINFOOT  
CONTROLS

TRANSMISSION

EXHAUST

TOOLS &  
GENERAL

# UPSWEEPS FOR 1980-1985 SWINGARM FRAME SPORTSTERS



## 1 3/4" UPSWEEP EXHAUST SYSTEMS FOR 1980-1985 SPORTSTERS

For 1980-1985 swingarm frames ONLY, but will fit 1957-1978 models if the shocks are removed and replaced with struts (see page 110 for struts). Use Paughco #725A clamps to attach these pipe sets to the exhaust ports. Heat shields are highly recommended.

**719B2** Straight Cut (includes a Paughco #718-4 hanger bracket)

**719B2FS** Fishtails (includes a Paughco #718-4 hanger bracket)

**719B2AS** Goose Cut (includes a Paughco #718NSA hanger bracket) shown below on bike

**719B2SS** Slash Cut (includes a Paughco #718NSA hanger bracket)

**419F** Front heat shield for Paughco #719B2 series pipe sets (shown below on bike)

**419B2R** Rear heat shield for Paughco #'s 719B2 and 719B2FS pipe sets (not shown)

**419R** Rear heat shield for Paughco #'s 719B2AS and 719B2SS pipe sets (shown below on bike)

**607FT** Clamp-on Mini Fishtail tip for all 1 3/4"-diameter pipes

**718-4** Hanger bracket for Paughco #'s 719B2 and 719B2FS

**718NSA** Hanger bracket for Paughco #'s 719B2AS and 719B2SS

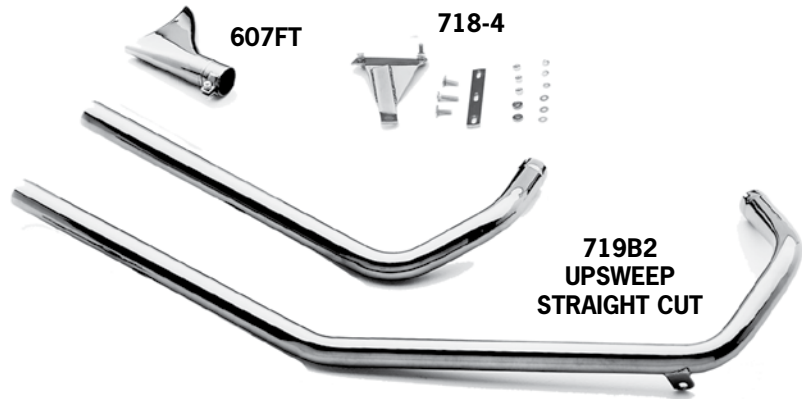

**719B2  
UPSWEEP  
STRAIGHT CUT**



**719B2FS  
UPSWEEP  
FISHTAIL**



**719B2SS  
UPSWEEP  
SLASH CUT**

### SPECIAL NOTES:

- 1) DRAG PIPES ARE NOT RECOMMENDED FOR USE ON THE STREET.
- 2) SEE PAGE 247 FOR CLAMPS TO INSTALL THESE PIPE SETS.
- 3) SEE PAGES 349-353 FOR PHOTOS OF THE HEAT SHIELDS FOR THESE PIPE SETS.



**719B2AS  
UPSWEEP GOOSE CUT**

336



VISIT US ON THE INTERNET AT [WWW.PAUGHCO.COM](http://WWW.PAUGHCO.COM)  
OR E-MAIL US AT [INFO@PAUGHCO.COM](mailto:INFO@PAUGHCO.COM)

# UPSWEEPS FOR 1957-1985 RIGID FRAME SPORTSTERS

TRIKE  
KITS

SPRINGERS  
& FORKS

HANDLEBARS  
& RISERS

LIGHTING

FRAMES &  
ACCESSORIES

WHEELS  
& BRAKES

GAS & OIL  
TANKS

SHEET  
METAL

ENGINE &  
ELECTRICAL

PRIMARY &  
DRIVETRAIN

FOOT  
CONTROLS

TRANSMISSION

EXHAUST

TOOLS &  
GENERAL

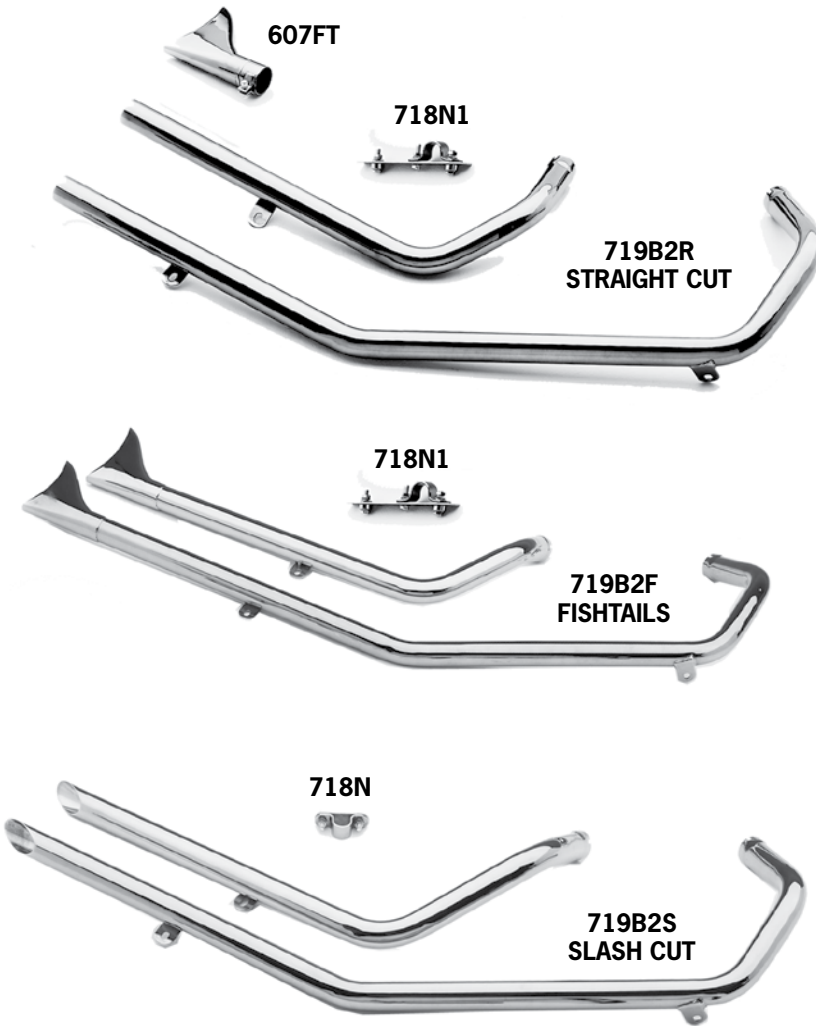

## 1 3/4" UPSWEEP EXHAUST SYSTEMS FOR 1957-1985 SPORTSTER ENGINES IN RIGID FRAMES

Use Paughco #725A clamps to attach these pipe sets to the exhaust ports. Heat shields are highly recommended.

- 719B2R** Straight Cut (includes a Paughco #718N1 hanger bracket)
- 719B2F** Fishtails (includes a Paughco #718N1 hanger bracket)
- 719B2A** Goose Cut (includes a Paughco #718N hanger bracket) shown on bike
- 719B2S** Slash Cut (includes a Paughco #718N hanger bracket)
- 419F** Front heat shield for Paughco #719B2 series pipe sets (shown below on bike)
- 419B2R** Rear heat shield for Paughco #'s 719B2R and 719B2F pipe sets (not shown)
- 419R** Rear heat shield for Paughco #'s 719B2A and 719B2S pipe sets (shown below on bike)
- 607FT** Clamp-on Mini Fishtail tip for all 1 3/4"-diameter pipes
- 718N1** Hanger bracket for Paughco #'s 719B2F and 719B2R pipe sets
- 718N** Hanger bracket for Paughco #'s 719B2A and 719B2S pipe sets

### SPECIAL NOTES:

- 1) DRAG PIPES ARE NOT RECOMMENDED FOR USE ON THE STREET.
- 2) SEE PAGE 247 FOR CLAMPS TO INSTALL THESE PIPE SETS.
- 3) SEE PAGES 349-353 FOR PHOTOS OF THE HEAT SHIELDS FOR THESE PIPE SETS.



719B2A  
GOOSE CUT

TO ORDER THESE PARTS, CALL US AT 775-246-5738  
OR TOLL FREE AT 800-423-2621



TRIKE  
KITSSPRINGS  
& FORKSHANDLEBARS  
& RISERS

LIGHTING

FRAMES &  
ACCESSORIESWHEELS  
& BRAKESGAS & OIL  
TANKSSHEET  
METALENGINE &  
ELECTRICALPRIMARY &  
DRIVETRAINFOOT  
CONTROLS

TRANSMISSION

EXHAUST

TOOLS &  
GENERAL

# SHOTGUNS FOR 1957-1985 RIGID FRAME SPORTSTERS



## 1 3/4" SHOTGUN EXHAUST SYSTEMS FOR 1957-1985 SPORTSTER ENGINES IN RIGID FRAMES

Use Paughco #725A clamps to attach these pipe sets to the exhaust ports. Heat shields are highly recommended.

**719D34** 34"-long Slash Cut drag pipes (use Paughco #725D clamps to install)

**719D40** 40"-long Slash Cut drag pipes with slider channels (use Paughco #725D clamps to install) shown below on bike

**719DGM** 38"-long Goose Cut muffler set with slider channels on mufflers

**719DM** 38"-long Slash Cut muffler set with slider channels on mufflers

**719DTM** 38"-long Tapered muffler set with slider channels on mufflers

**419F** Front heat shield for Paughco #719D series pipe sets (shown on bike)

**419DR** Rear heat shield for Paughco #'s 719D34, 719D40 pipe sets (shown on bike)

**419DRS** Rear heat shield for #'s 719DGM, 719DTM and 719DM pipe sets (not shown)



**719D34**  
34"-LONG SHOTGUN  
SLASH CUT DRAG PIPES



**719DGM**  
38"-LONG SHOTGUN  
GOOSE CUT

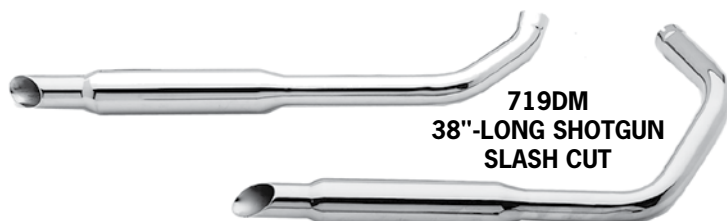

**719DM**  
38"-LONG SHOTGUN  
SLASH CUT

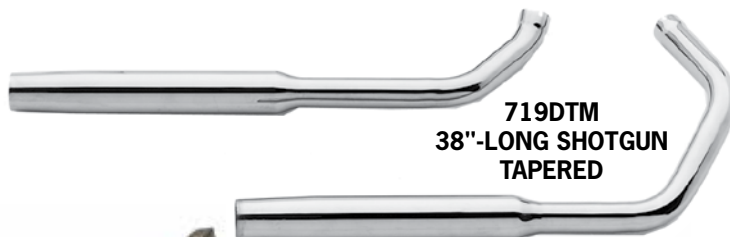

**719DTM**  
38"-LONG SHOTGUN  
TAPERED

**719D40**  
40"-LONG SHOTGUN  
SLASH CUT DRAG PIPES

### SPECIAL NOTES:

- 1) DRAG PIPES ARE NOT RECOMMENDED FOR USE ON THE STREET.
- 2) SEE PAGE 247 FOR CLAMPS TO INSTALL THESE PIPE SETS.
- 3) SEE PAGES 349-353 FOR PHOTOS OF THE HEAT SHIELDS FOR THESE PIPE SETS.

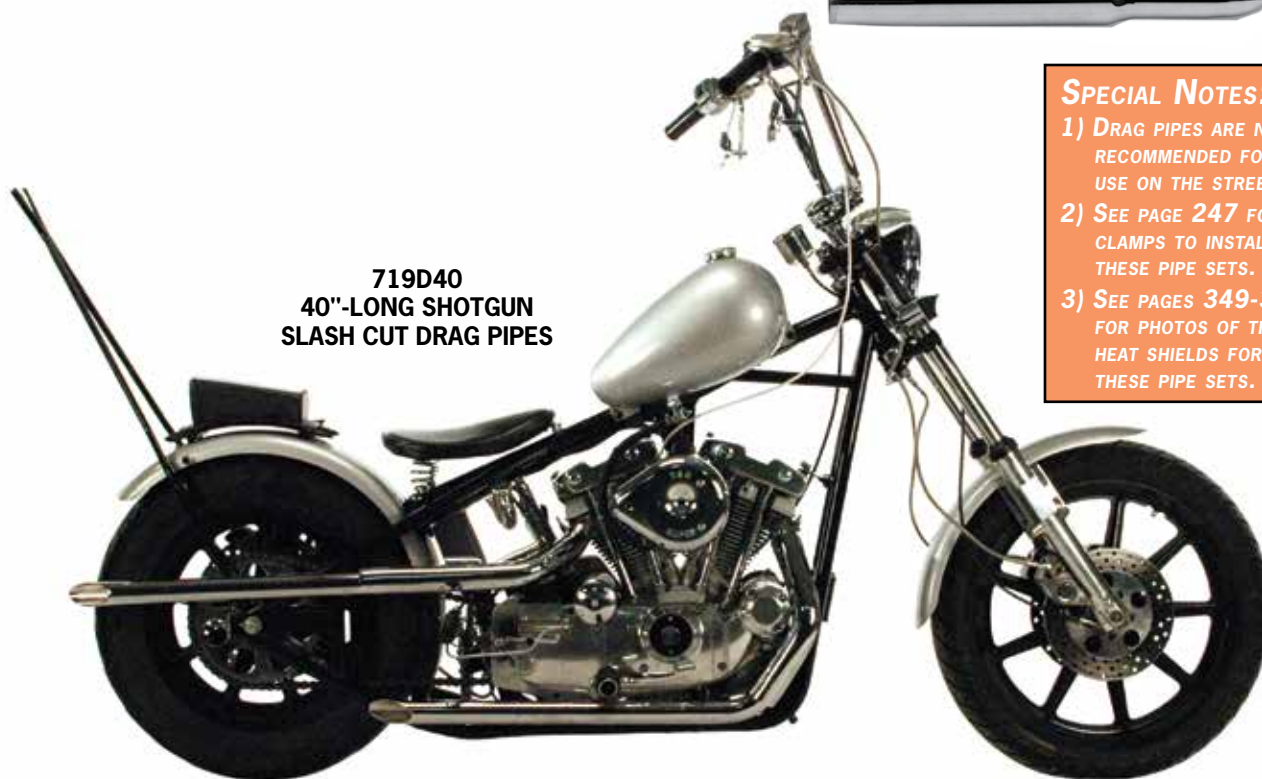

338

VISIT US ON THE INTERNET AT [WWW.PAUGHCO.COM](http://WWW.PAUGHCO.COM)  
OR E-MAIL US AT [INFO@PAUGHCO.COM](mailto:INFO@PAUGHCO.COM)

TRIKE  
KITSSPRINGS  
& FORKSHANDLEBARS  
& RISERS

LIGHTING

FRAMES &  
ACCESSORIESWHEELS  
& BRAKESGAS & OIL  
TANKSSHEET  
METALENGINE &  
ELECTRICALPRIMARY &  
DRIVETRAINFOOT  
CONTROLS

TRANSMISSION

EXHAUST

TOOLS &  
GENERAL

# STAGGERED DUALS For 1986-2003 EVOLUTION SPORTSTERS

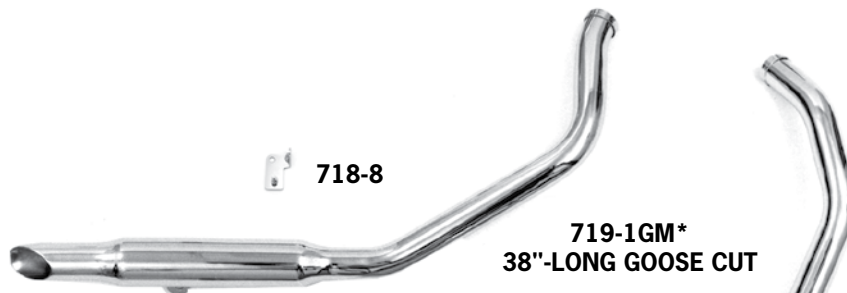

## 1 3/4" STAGGERED DUAL PIPE SETS FOR 1986-2003 EVOLUTION SPORTSTERS

These drag pipes and muffler sets bolt to the stock HD mounting bracket for a quick and painless installation. They fit all 883, 1100 and 1200 models thru 2003 (not rubber-mounted engines), and include a Paughco #718-8 brake pedal stop/mounting bracket.



**719-1A40\*** 40"-long Goose Cut drag pipes (shown below on bike)

**719-1-40\*** 40"-long Slash Cut drag pipes (not shown)

**719-1GM\*** 38"-long Goose Cut muffler set

**719-1M\*** 38"-long Slash Cut muffler set

**719-1-2M\*** 38"-long Super Slash Cuts

**419-1F** Front heat shield for Paughco #719-1 series pipe sets (shown below on bike)

**419-1R** Rear heat shield for Paughco #719-1 series pipe sets (shown below on bike)

**718-8** Brake pedal stop/mounting bracket for Paughco #719-1 series pipe sets

**\* NOT LEGAL FOR SALE OR USE IN CALIFORNIA**

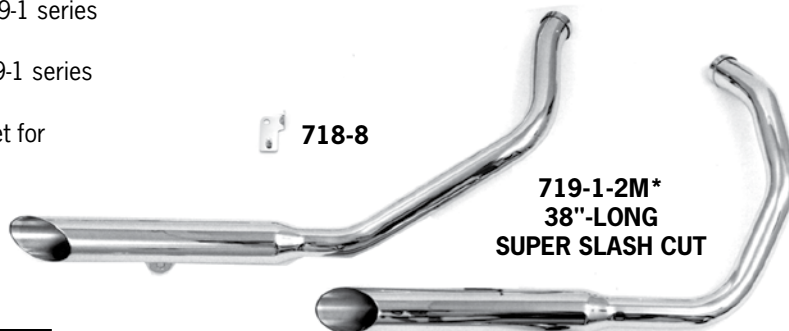
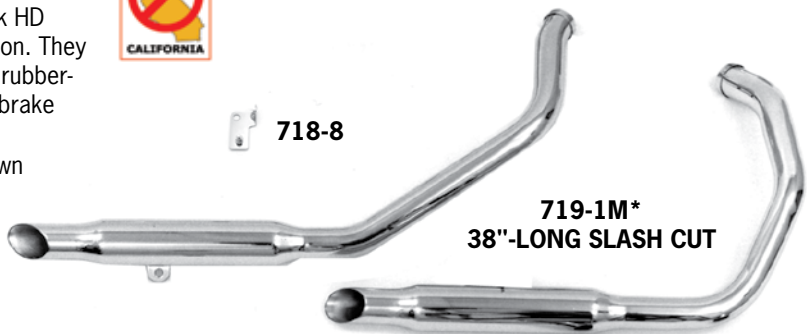

### SPECIAL NOTES:

- 1) DRAG PIPES ARE NOT RECOMMENDED FOR USE ON THE STREET.
- 2) SEE PAGES 349-353 FOR PHOTOS OF THE HEAT SHIELDS FOR THESE PIPE SETS.



**719-1A40\***  
40"-LONG GOOSE CUT  
DRAG PIPES

340



VISIT US ON THE INTERNET AT [WWW.PAUGHCO.COM](http://WWW.PAUGHCO.COM)  
OR E-MAIL US AT [INFO@PAUGHCO.COM](mailto:INFO@PAUGHCO.COM)



# EXHAUST SYSTEMS FOR 1986-2003 EVOLUTION SPORTSTERS

TRIKE KITS

SPRINGERS & FORKS

HANDLEBARS & RISERS

LIGHTING

FRAMES & ACCESSORIES

WHEELS & BRAKES

GAS & OIL TANKS

SHEET METAL

ENGINE & ELECTRICAL

PRIMARY & DRIVETRAIN

FOOT CONTROLS

TRANSMISSION

EXHAUST

TOOLS & GENERAL

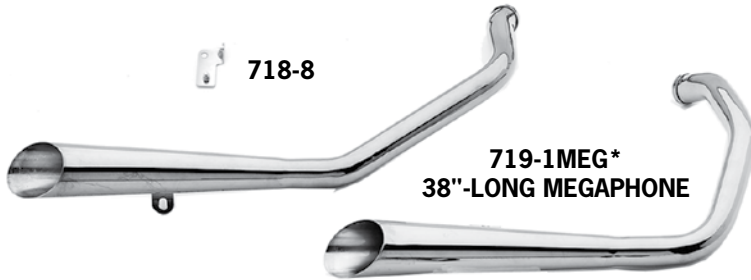

**719-1MEG\***  
38"-LONG MEGAPHONE

## 1 3/4" EXHAUST SYSTEMS FOR 1986-2003 EVOLUTION SPORTSTERS

A variety of exhaust systems for early 883, 1100 and 1200 Evolution Sportsters, including a set of Shotgun drag pipes for engines that are mounted in rigid frames. Heat shields are highly recommended.

HEAT SHIELD PHOTOS CAN BE SEEN ON PAGES 349-353

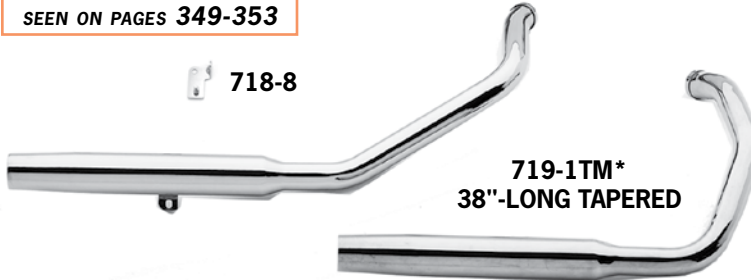

**719-1TM\***  
38"-LONG TAPERED

**719-1MEG\*** 38"-long Megaphone muffler set with a slider channel on the front pipe (includes a Paughco #718-8 brake pedal stop and mounting bracket)

**719-1TM\*** 38"-long Tapered muffler set with a slider channel on the front pipe (includes a Paughco #718-8 brake pedal stop and mounting bracket)

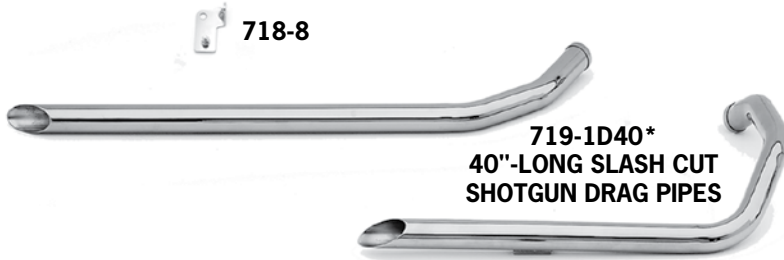

**719-1D40\***  
40"-LONG SLASH CUT SHOTGUN DRAG PIPES

**719-1D40\*** 40"-long Slash Cut Shotgun drag pipes with slider channels for rigid frames ONLY (includes a Paughco #718-8 brake pedal stop and mounting bracket)

**719C1\*** 2-into-1 headpipe set with slider channel on front pipe for use with a tailpipe extension or muffler (includes a Paughco #718-3 hanger bracket)

**419-1F** Front heat shield for Paughco #'s 719C1, 719-1MEG, 719-1TM and 719-1D40 pipe sets (shown below on bike)

**419-1R** Rear heat shield for Paughco #'s 719-1TM and 719-1MEG pipe sets (shown below on bike)

**419-1DR** Rear heat shield for Paughco #719-1D40 pipe set (not shown)

**419C1R** Rear heat shield for Paughco #719C1 pipe set (not shown)

**718-3** Brake pedal stop and hanger bracket kit for Paughco #719C1 pipe set

**718-8** Brake pedal stop/mounting bracket for Paughco #'s 719-1D40, 719-1MEG and 719-1TM pipe sets

**\* NOT LEGAL FOR SALE OR USE IN CALIFORNIA**



**719C1\***  
2-INTO-1 HEADPIPES



**719-1TM\***  
38"-LONG TAPERED

TO ORDER THESE PARTS, CALL US AT 775-246-5738  
OR TOLL FREE AT 800-423-2621



TRIKE  
KITS

SPRINGS  
& FORKS

HANDLEBARS  
& RISERS

LIGHTING

FRAMES &  
ACCESSORIES

WHEELS  
& BRAKES

GAS & OIL  
TANKS

SHEET  
METAL

ENGINE &  
ELECTRICAL

PRIMARY &  
DRIVETRAIN

FOOT  
CONTROLS

TRANSMISSION

EXHAUST

TOOLS &  
GENERAL

# UPSWEEPS FOR 1986-2003 EVOLUTION SPORTSTERS



**719-1SUS\***  
**UPSWEEP SLASH CUT**

## 1 3/4" UPSWEEP EXHAUST SYSTEMS FOR 1986-2003 EVOLUTION SPORTSTERS

These upsweep exhaust systems can be fitted to early 883, 1100 and 1200 Evolution Sportster engines (not rubber-mounted) in stock HD swingarm frames. Each set includes a Paughco #718-7 bracket kit to simplify installation. Heat shields are highly recommended.

**719-1SUS\*** Slash Cut drag pipes

**719-1GUS\*** Goose Cut drag pipes

**719-1TUS\*** Straight Cut drag pipes (shown below on bike)

**419-1F** Front heat shield for Paughco #719-1 series pipe sets (not shown)

**419-1RU** Rear heat shield for Paughco #719-1 upsweep series pipe sets (not shown)

**718-7** Replacement hanger bracket for swingarm frames



**718-7**



**719-1GUS\***  
**UPSWEEP GOOSE CUT**

**\* NOT LEGAL FOR SALE OR USE IN CALIFORNIA**

### SPECIAL NOTES:

- 1) STRAIGHT PIPES ARE NOT RECOMMENDED FOR USE ON THE STREET.
- 2) SEE PAGES 349-353 FOR PHOTOS OF THE HEAT SHIELDS FOR THESE PIPE SETS.



**719-1TUS\***  
**UPSWEEP STRAIGHT CUT**



VISIT US ON THE INTERNET AT [WWW.PAUGHCO.COM](http://WWW.PAUGHCO.COM)  
OR E-MAIL US AT [INFO@PAUGHCO.COM](mailto:INFO@PAUGHCO.COM)

# UPSWEEPS FOR RIGID FRAME EVOLUTION SPORTSTERS

TRIKE  
KITS

SPRINGERS  
& FORKS

HANDLEBARS  
& RISERS

LIGHTING

FRAMES &  
ACCESSORIES

WHEELS  
& BRAKES

GAS & OIL  
TANKS

SHEET  
METAL

ENGINE &  
ELECTRICAL

PRIMARY &  
DRIVETRAIN

FOOT  
CONTROLS

TRANSMISSION

EXHAUST

TOOLS &  
GENERAL



**719-1SUR\*  
UPSWEEP SLASH CUT**



**718SBR**



## 1 3/4" UPSWEEP EXHAUST SYSTEMS FOR 1986-2003 EVOLUTION SPORTSTER ENGINES IN RIGID FRAMES

These Upsweep exhaust systems can be fitted to early 883, 1100 and 1200 Evolution Sportster engines (not rubber-mounted) in Paughco rigid frames. Each set includes a Paughco #718SBR mounting kit to ease installation. Heat shields are highly recommended.

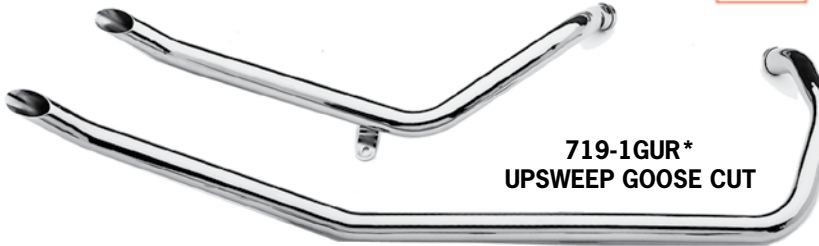

**719-1GUR\*  
UPSWEEP GOOSE CUT**

**719-1SUR\*** Slash Cut

**719-1GUR\*** Goose Cut

**719-1TUR\*** Straight Cut

**419-1F** Front heat shield for Paughco #719-1 series pipe sets (shown below on bike)

**419-1RU** Rear heat shield for Paughco #719-1 upsweep series pipe sets (shown below on bike)

**718SBR** Replacement hanger bracket for rigid frames

**\* NOT LEGAL FOR SALE OR USE IN CALIFORNIA**



**719-1TUR\*  
UPSWEEP STRAIGHT CUT**

### SPECIAL NOTES:

- 1) STRAIGHT PIPES ARE NOT RECOMMENDED FOR USE ON THE STREET.
- 2) SEE PAGES 349-353 FOR PHOTOS OF THE HEAT SHIELDS FOR THESE PIPE SETS.

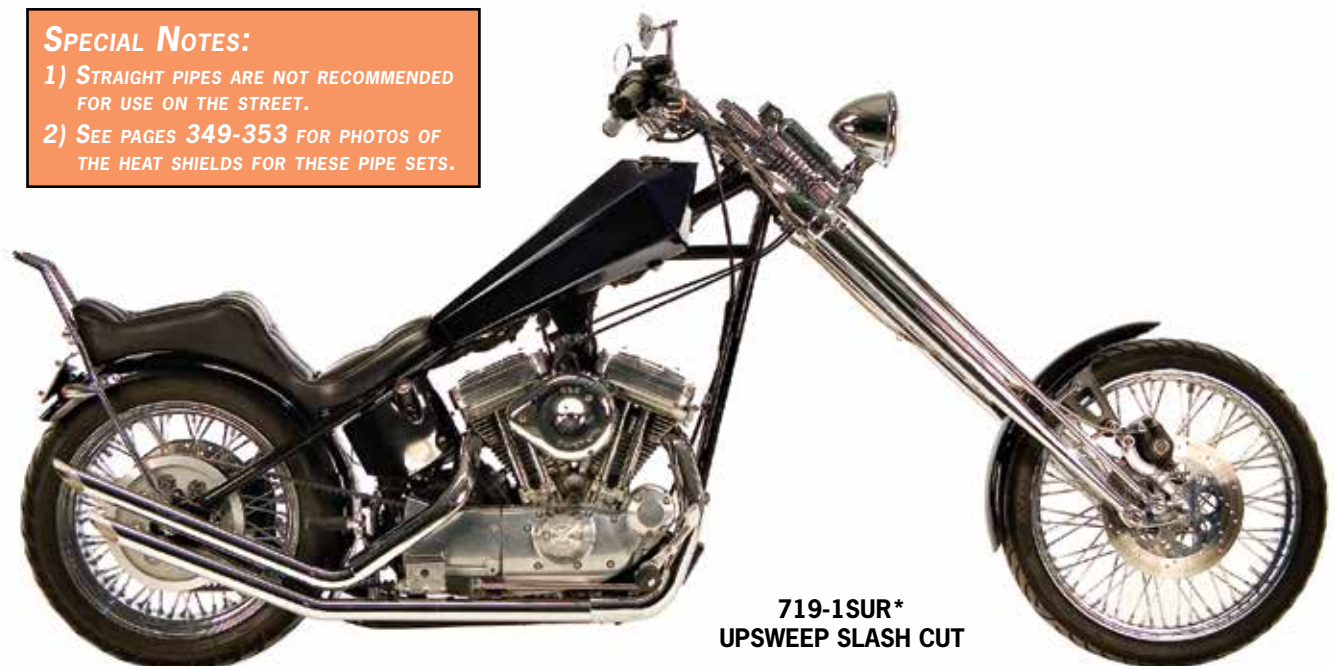

**719-1SUR\*  
UPSWEEP SLASH CUT**

TO ORDER THESE PARTS, CALL US AT **775-246-5738**  
OR TOLL FREE AT **800-423-2621**



TRIKE  
KITSSPRINGS  
& FORKSHANDLEBARS  
& RISERS

LIGHTING

FRAMES &  
ACCESSORIESWHEELS  
& BRAKESGAS & OIL  
TANKSSHEET  
METALENGINE &  
ELECTRICALPRIMARY &  
DRIVETRAINFOOT  
CONTROLS

TRANSMISSION

EXHAUST

TOOLS &  
GENERAL

# EXHAUST SYSTEMS For 1986-2003 EVOLUTION SPORTSTERS



## 1 3/4" SHOTGUN DRAG PIPES FOR 1986-2003 SPORTSTER ENGINES IN RIGID FRAMES

This drag pipe set will fit all 1986–2003 Evolution Sportster engines (not rubber-mounted) when installed in Paughco rigid frames. The front pipe is 60"-long and the rear is 40"-long, and the set includes a Paughco #718SBR-2 hanger bracket.

**719-1D2R\*** Slash Cut drag pipes

**718SBR-2** Replacement hanger bracket for #719-1D2R pipe set



**\* NOT LEGAL FOR SALE OR USE IN CALIFORNIA**

## PAUGHCO EXHAUST HANGER BRACKETS For 2004-2013 SPORTSTER MODELS

Replacement exhaust brackets for rubber-mounted Sportster models. Great for swapping out when upgrading to aftermarket exhaust systems. These brackets eliminate the unsightly crossover breather tube on the OEM brackets and also weigh 30% less than stock. Available in chrome or with a gloss black powdercoat.

**718XLL** Chrome

**718XLLB** Black



# EXHAUST SYSTEMS FOR 1986-2003 EVOLUTION SPORTSTERS



## 1 3/4" UPSWEEP SHOTGUN EXHAUST SYSTEMS FOR 1986-2003 RIGID FRAME EVOLUTION SPORTSTERS

These Upsweep Fishtail and headpipe sets will fit all 1986–2003 Evolution Sportster engines (not rubber-mounted) when installed in Paughco rigid frames. Combine the headpipe set with Paughco Fishtail or Bell Tip mufflers to customize your exhaust system. Heat shields are recommended.

- 719-1FU\*** Complete Upsweep Fishtail exhaust system (includes a Paughco #718N2 hanger bracket kit)
- 719-1B2R\*** Upsweep headpipe set ONLY (includes a Paughco #718SBR-1 hanger bracket kit)
- 419-1F** Front heat shield (shown below on bike)
- 419-1DRU** Rear heat shield (shown below on bike)
- 718N2** Hanger bracket kit for #719-1FU pipe set
- 718SBR-1** Hanger bracket kit for #719-1B2R pipe set (includes a rear muffler support mounting strap)

### MUFFLERS

Two styles to choose from including a redux of the 'Old School' Bell Tip trumpet mufflers. Sold each.

- 608S\*** 22 1/2"-long Fishtail mufflers
- 618BT\*** 20"-long Bell Tip mufflers
- 619BT\*** 22"-long Bell Tip mufflers

**\* NOT LEGAL FOR SALE OR USE IN CALIFORNIA**

### SPECIAL NOTES:

- 1) STRAIGHT PIPES ARE NOT RECOMMENDED FOR USE ON THE STREET.
- 2) SEE PAGES 349-353 FOR PHOTOS OF THE HEAT SHIELDS FOR THESE PIPE SETS



**719-1B2R  
UPSWEEP HEADPIPES  
WITH 618BT BELL TIP MUFFLERS**

**TO ORDER THESE PARTS, CALL US AT 775-246-5738  
OR TOLL FREE AT 800-423-2621**



TRIKE  
KITS

SPRINGERS  
& FORKS

HANDLEBARS  
& RISERS

LIGHTING

FRAMES &  
ACCESSORIES

WHEELS  
& BRAKES

GAS & OIL  
TANKS

SHEET  
METAL

ENGINE &  
ELECTRICAL

PRIMARY &  
DRIVETRAIN

FOOT  
CONTROLS

TRANSMISSION

EXHAUST

TOOLS &  
GENERAL

TRIKE  
KITSSPRINGERS  
& FORKSHANDLEBARS  
& RISERS

LIGHTING

FRAMES &  
ACCESSORIESWHEELS  
& BRAKESGAS & OIL  
TANKSSHEET  
METALENGINE &  
ELECTRICALPRIMARY &  
DRIVETRAINFOOT  
CONTROLS

TRANSMISSION

EXHAUST

TOOLS &  
GENERAL

# EXHAUST SYSTEMS For 2004-2020 EVOLUTION SPORTSTERS



## 1 3/4" 'SIDE-BY-SIDE' UPSWEEP FISHTAILS For 2004-2020 RUBBER-MOUNTED SPORTSTERS

Upswept fishtails feature long, one-piece 1 3/4" headpipes with blended fishtails that cross to a 'side-by-side' styling at the tips. They bolt to the OEM exhaust bracket or to chrome Paughco #718XLL or black #718XLLB replacement brackets without the factory crossover tube (thru 2013... sold separately). They include O<sup>2</sup> sensor bungs for 2007-2020 models and block-off plugs for the 2004-2006 models, and are available with chrome-plated or high heat satin black powdercoated finishes. Heat shields sold separately.

**719-3-SBS\*** Chrome for 2004-2013

**719-4-SBS\*** Chrome for 2014-2020

**719-3-SBSB\*** Black for 2004-2013

**719-4-SBSB\*** Black for 2014-2020

### FRONT AND REAR HEAT SHIELD SETS

**419SBS** Chrome for 2004-2013

**419-4SBS** Chrome for 2014-2020

**419SBSB** Black for 2004-2013

**419-4SBSB** Black for 2014-2020



\* NOT LEGAL FOR SALE OR USE IN CALIFORNIA



## BLACK 'STEP-WELDED' STAGGERED DUALS For 2004-2020 RUBBER-MOUNTED EVOLUTION SPORTSTERS

These sets feature 1 3/4" upper headpipes step-welded into 2" lower headpipes which are in turn welded into 2 1/4" muffler bodies with bolt-in baffles and chrome tips.

Run them as drag pipes or as baffled muffler pipes. The black high-heat powderpaint finish with rough welded seams

confer a 'handmade' look. Includes O<sup>2</sup> sensor bungs for the 2007-2020 models, and block-off plugs for the 2004-2006 models. They bolt to the OEM exhaust bracket or Paughco #718XLL chrome or #718XLLB black brackets that eliminate the factory crossover tube (thru 2013 models... sold separately).

**719-3-STP\*** For 2004-2013

**719-4-STP\*** For 2014-2020

\* NOT LEGAL FOR SALE OR USE IN CALIFORNIA



346



VISIT US ON THE INTERNET AT [WWW.PAUGHCO.COM](http://WWW.PAUGHCO.COM)  
OR E-MAIL US AT [INFO@PAUGHCO.COM](mailto:INFO@PAUGHCO.COM)

# EXHAUST SYSTEMS FOR 2004-2020 EVOLUTION SPORTSTERS



719-3-1TM\*



719-3-604MB\*



Tapered



Straight Cut



419-3CST

## 1 3/4" STAGGERED DUALS FOR 2004-2020 RUBBER-MOUNTED EVOLUTION SPORTSTERS

These exhaust sets feature 1 3/4"-diameter headpipes welded and smooth-polished into 2 1/2"-diameter mufflers, and are available in chrome or with a high-heat black powderpaint finish. All pipe sets are fitted with O<sup>2</sup> sensor bungs for 2007–2020 models, and include block-off plugs for the 2004–2006 models. They bolt to the original OEM mounting bracket or to chrome Paughco #718XLL or black #718XLLB replacement brackets without the factory crossover tube (thru 2013 models... sold separately). 2 1/4"-diameter front and rear heat shield sets are also available separately. **\* NOT LEGAL FOR SALE OR USE IN CALIFORNIA**

### MUFFLER SETS & HEAT SHIELDS FOR 2004-2013 MODELS

- 719-3-1TM\* 40"-long chrome tapered set
- 719-3-1TMB\* 40"-long black tapered set
- 719-3-604M\* 38"-long chrome straight cut set
- 719-3-604MB\* 38"-long black straight cut set
- 419-3CST Chrome heat shield set
- 419-3BST Black heat shield set

### MUFFLER SETS & HEAT SHIELDS FOR 2014-2020 MODELS

- 719-4-1TM\* 40"-long chrome tapered set
- 719-4-1TMB\* 40"-long black tapered set
- 719-4-604M\* 38"-long chrome straight cut set
- 719-4-604MB\* 38"-long black straight cut set
- 419-4CST Chrome heat shield set
- 419-4BST Black heat shield set

TO ORDER THESE PARTS, CALL US AT 775-246-5738  
OR TOLL FREE AT 800-423-2621



TRIKE  
KITS

SPRINGERS  
& FORKS

HANDLEBARS  
& RISERS

LIGHTING

FRAMES &  
ACCESSORIES

WHEELS  
& BRAKES

GAS & OIL  
TANKS

SHEET  
METAL

ENGINE &  
ELECTRICAL

PRIMARY &  
DRIVETRAIN

FOOT  
CONTROLS

TRANSMISSION

EXHAUST

TOOLS &  
GENERAL

TRIKE  
KITSSPRINGERS  
& FORKSHANDLEBARS  
& RISERS

LIGHTING

FRAMES &  
ACCESSORIESWHEELS  
& BRAKESGAS & OIL  
TANKSSHEET  
METALENGINE &  
ELECTRICALPRIMARY &  
DRIVETRAINFOOT  
CONTROLS

TRANSMISSION

EXHAUST

TOOLS &  
GENERAL

# DRAG PIPES FOR 2004-2020 EVOLUTION SPORTSTERS



719-3-40\*  
40"-LONG SLASH CUT  
DRAG PIPES



719-3A40\*  
40"-LONG GOOSE CUT  
DRAG PIPES



## 1 3/4" STAGGERED DUAL DRAG PIPES FOR 2004-2020 EVOLUTION SPORTSTERS

These 40"-long drag pipes will fit all 2004–2020 rubber-mounted 883cc and 1200cc Evolution Sportster models with mid-controls or factory-installed forward controls. Each set includes a mounting kit, and you can re-use your stock heat shields.

**719-3-40\*** Slash Cut drag pipes for 2004–2013

**719-4-40\*** Slash Cut drag pipes for 2014–2020

**719-3A40\*** Goose Cut drag pipes for 2004–2013

**719-4A40\*** Goose Cut drag pipes for 2014–2020

**719-2-40HK** Replacement hardware kit for #719-3 pipe sets

**719-4-40HK** Replacement hardware kit for #719-4 pipe sets

**\* NOT LEGAL FOR SALE OR USE IN CALIFORNIA**



O<sup>2</sup> SENSOR BUNG

719-3-40\*  
40"-LONG  
SLASH CUT  
DRAG PIPES



719-3A40\*  
40"-LONG GOOSE CUT DRAG PIPES



348



VISIT US ON THE INTERNET AT [WWW.PAUGHCO.COM](http://WWW.PAUGHCO.COM)  
OR E-MAIL US AT [INFO@PAUGHCO.COM](mailto:INFO@PAUGHCO.COM)