

# 2J7724Ba

## CELLULAR/LTE MIMO Screw Mount

### Key Features

#### Cable 1 - 2: CELLULAR / LTE

- 698-960 MHz
- 1710-2170 MHz
- 2500-2700 MHz

Screw Mount

High Performance

Ground Plane Dependent

Customizable Cable and Connector

Dimensions: Ø 60 x 69 mm

Certificates IP67, IP69, IK09



## 1. Antenna and electrical specifications

### Cable 1

Parameters	CELLULAR / LTE Antenna		
<b>Standards</b>	2G,3G and 4G		
<b>Band (MHz)</b>	700/850/900	1700/1800/1900/2100	2600
<b>Frequency (MHz)</b>	698-960	1710-2170	2500-2700
<b>Return Loss (dB)</b>	~-6.9	~-15.3	~-16.7
<b>VSWR</b>	~2.9:1	~1.4:1	~1.4:1
<b>Efficiency (%)</b>	~37.8	~53.3	~54.9
<b>Peak Gain (dBi)</b>	~-0.8	~3.6	~4.1
<b>Average Gain (dB)</b>	~-4.3	~-2.7	~-2.6
<b>Impedance (Ohm)</b>	50		
<b>Polarisation</b>	Linear		
<b>Radiation Pattern</b>	Omni-Directional		
<b>Max. Input Power (W)</b>	25		
<b>Connector Type</b>	SMA-Male Standard (Other Connectors Available)		
<b>Cable Length</b>	300 cm Standard (Any Cable Length Available)		
<b>Cable Type</b>	LL100 Standard (Other Cables Available)		

### Cable 2

Parameters	CELLULAR / LTE Antenna		
<b>Standards</b>	2G,3G and 4G		
<b>Band (MHz)</b>	700/850/900	1700/1800/1900/2100	2600
<b>Frequency (MHz)</b>	698-960	1710-2170	2500-2700
<b>Return Loss (dB)</b>	~-6.8	~-14.3	~-9.3
<b>VSWR</b>	~2.8:1	~1.5:1	~2.1:1
<b>Efficiency (%)</b>	~38.7	~52.3	~42.1
<b>Peak Gain (dBi)</b>	~-0.6	~2.9	~3.0
<b>Average Gain (dB)</b>	~-4.2	~-2.8	~-3.8
<b>Impedance (Ohm)</b>	50		
<b>Polarisation</b>	Linear		
<b>Radiation Pattern</b>	Omni-Directional		
<b>Max. Input Power (W)</b>	25		
<b>Connector Type</b>	SMA-Male Standard (Other Connectors Available)		
<b>Cable Length</b>	300 cm Standard (Any Cable Length Available)		
<b>Cable Type</b>	LL100 Standard (Other Cables Available)		

### Antenna Measurement Conditions:

Mounted on 30 x 30 cm Ground Plane

200 cm of Cable LL100

Measured in Certified CTIA 3D Anechoic Chamber

## 2. Mechanical and environmental specifications

Specifications	2J7724Ba
<b>Mounting Type</b>	Screw Mount
<b>Dimensions (mm)</b>	Ø 60 x 69
<b>Max. Tighten Torque (Nm)</b>	6 Nm
<b>Radome Type</b>	PC/ABS UV Stable
<b>Radome Color</b>	Black
<b>Antenna Base</b>	Zamak
<b>Gasket</b>	TPE
<b>Operating Temperature (C)</b>	-40 to +85
<b>Storage Temperature (C)</b>	-40 to +85
<b>Substance Compliance</b>	RoHS
<b>Certificates</b>	IP67, IP69, IK09

### 3. Antenna parameters

Cable 1: CELLULAR/LTE

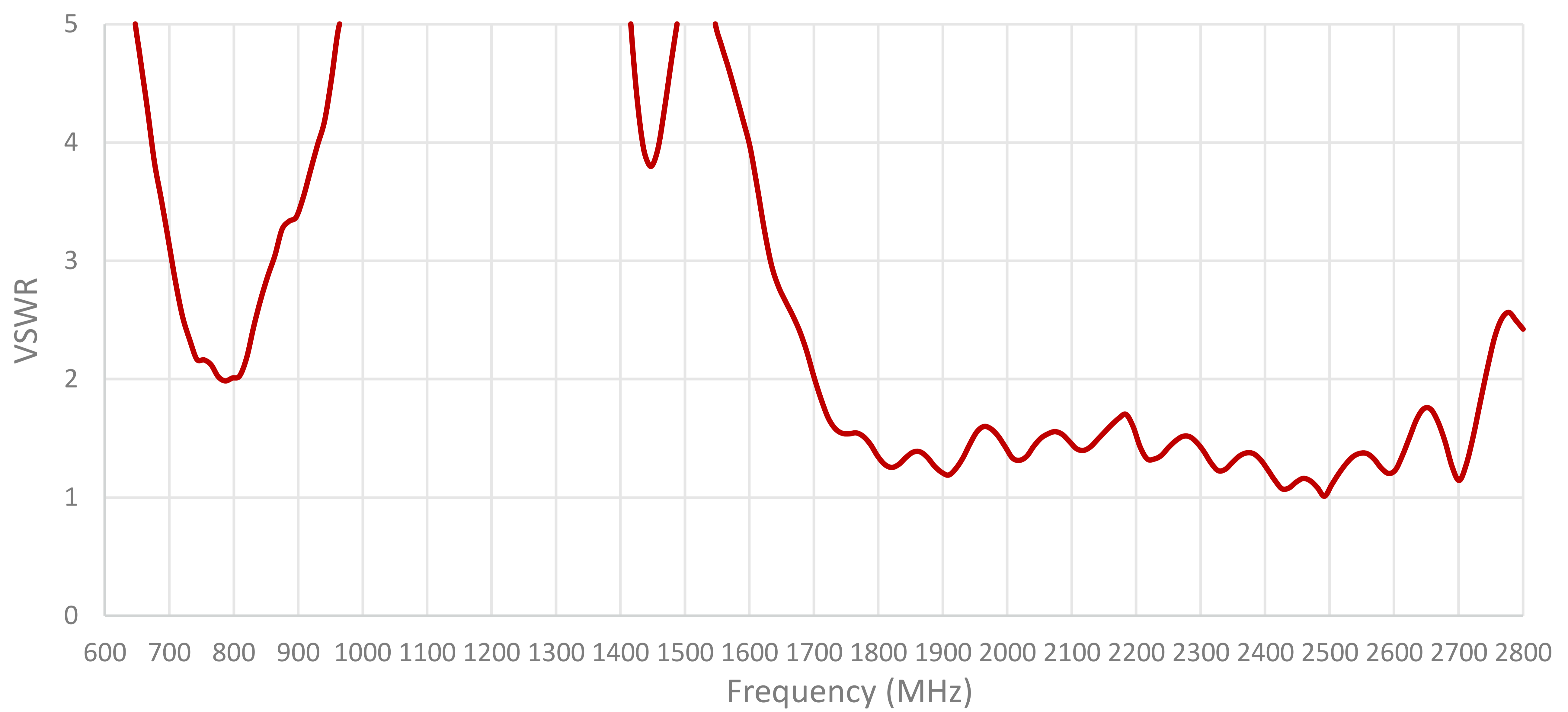
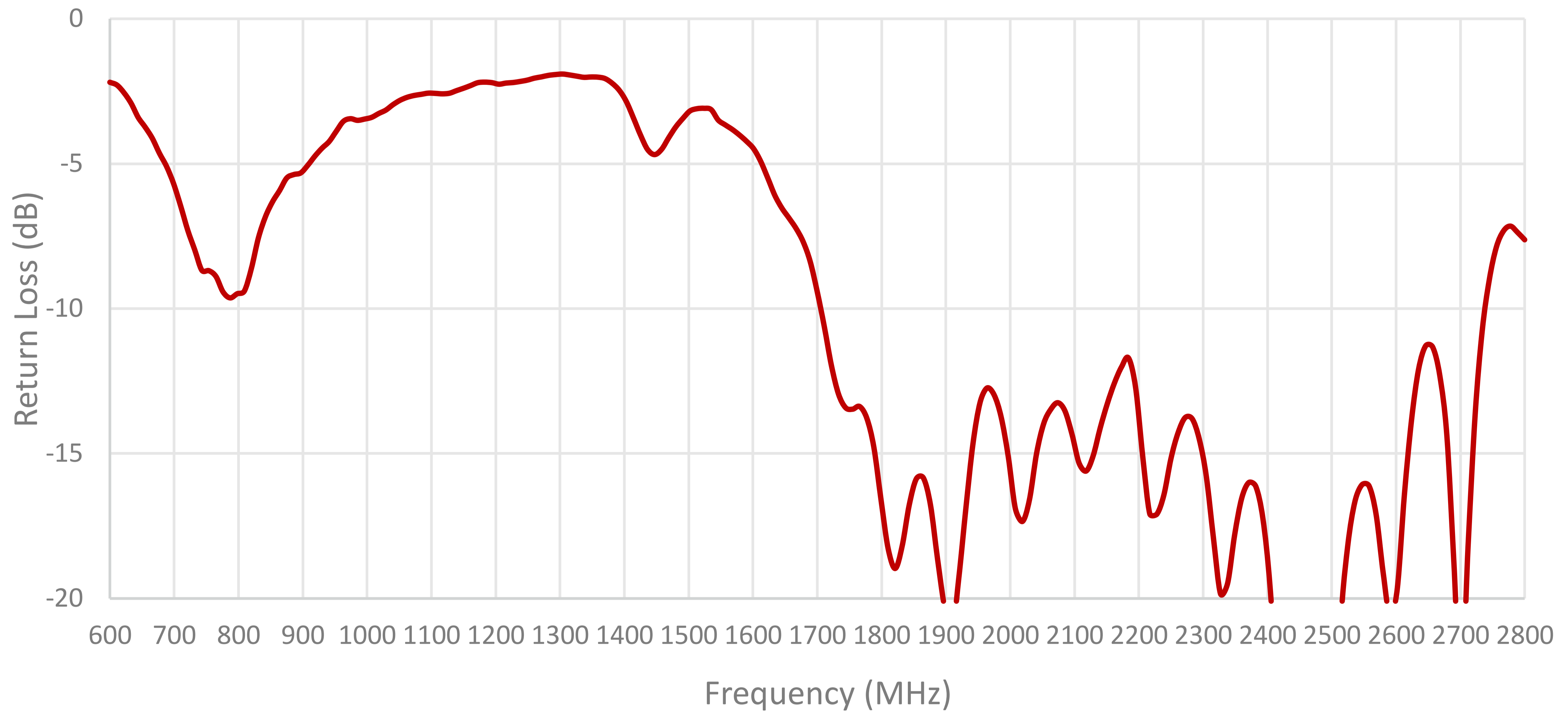

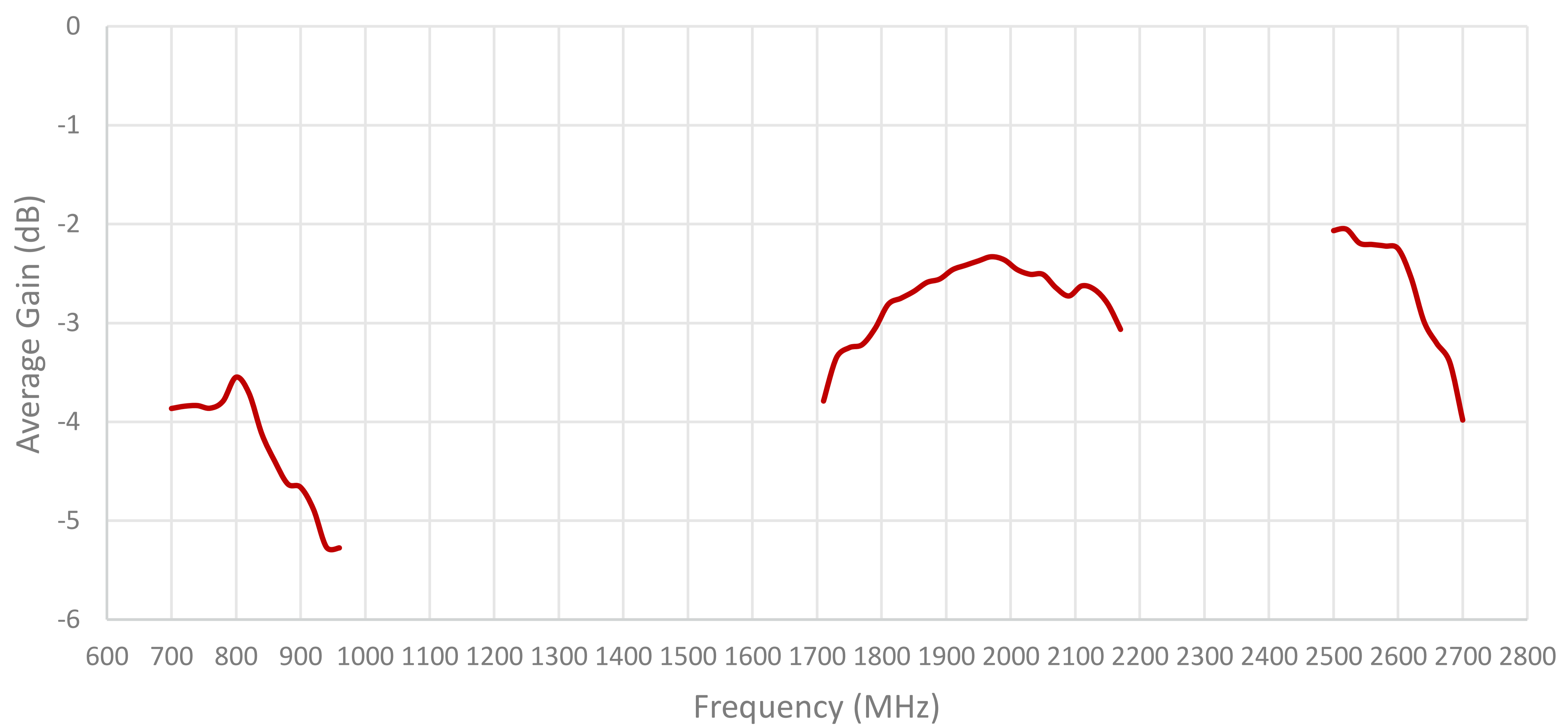
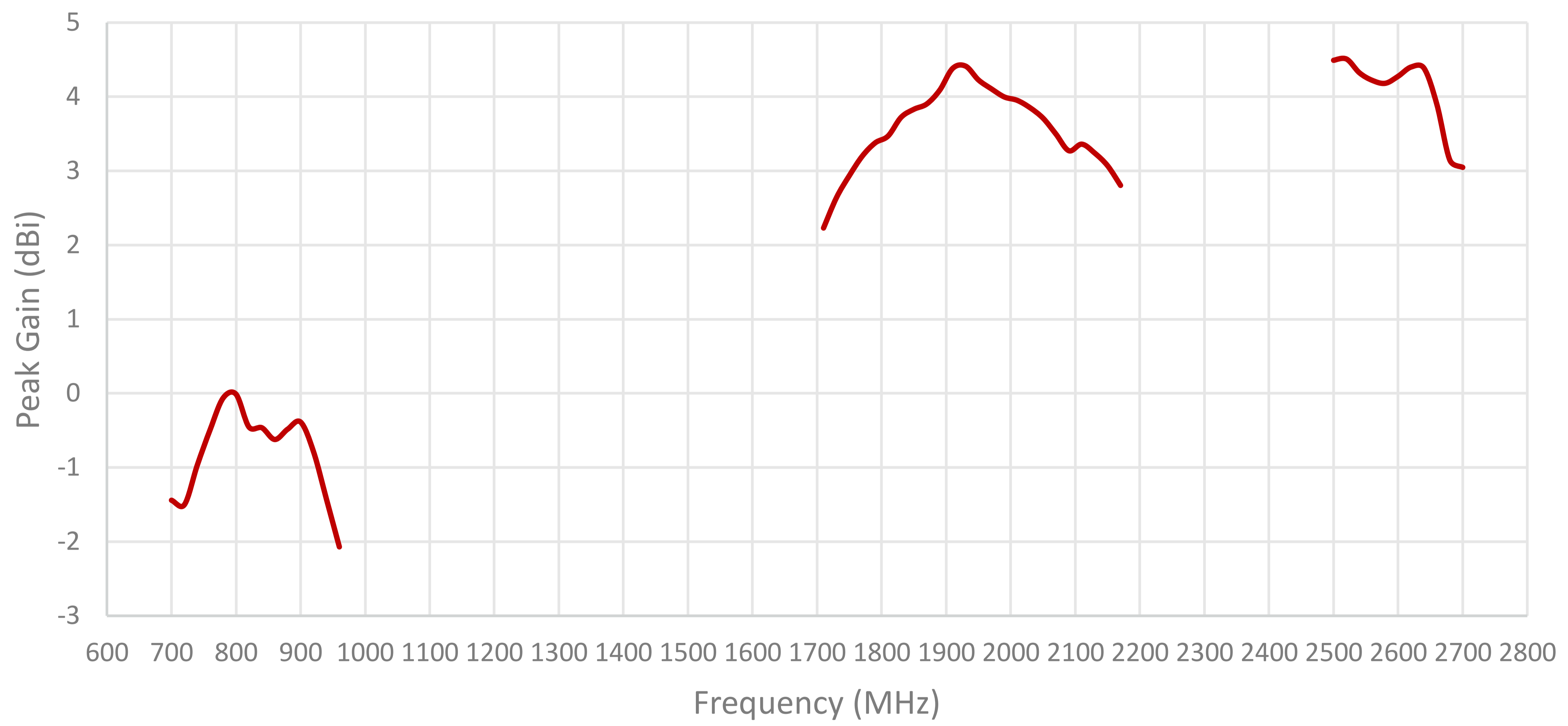
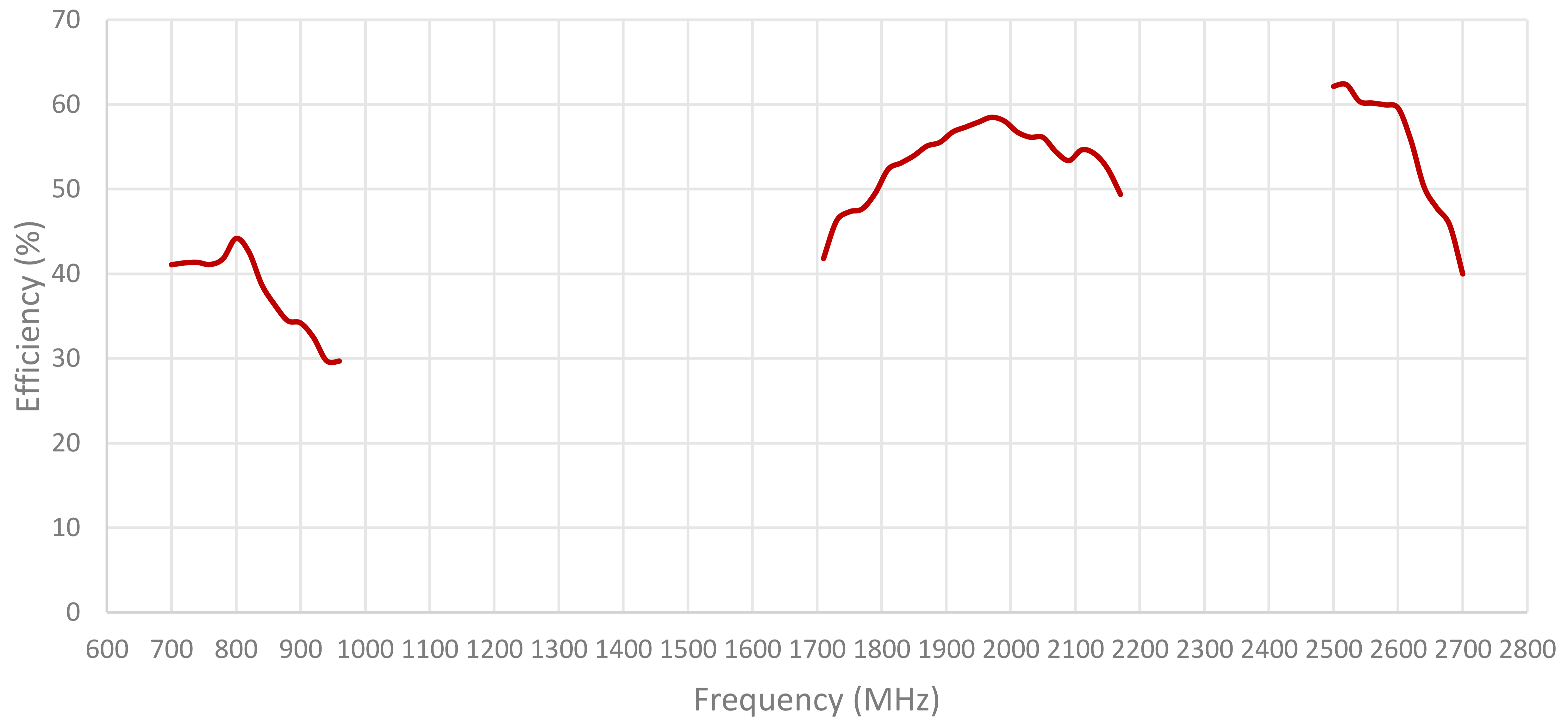

Cable 2: CELLULAR/LTE

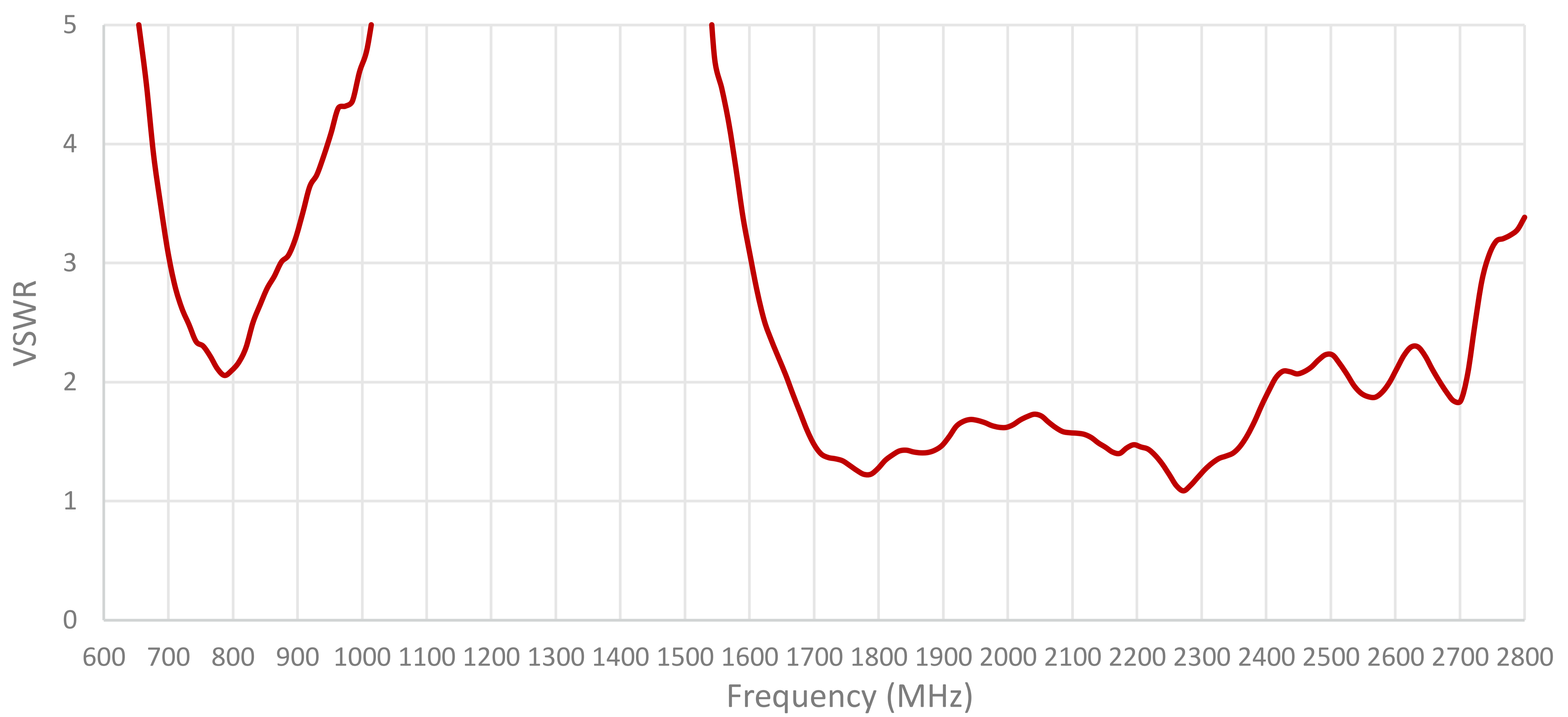
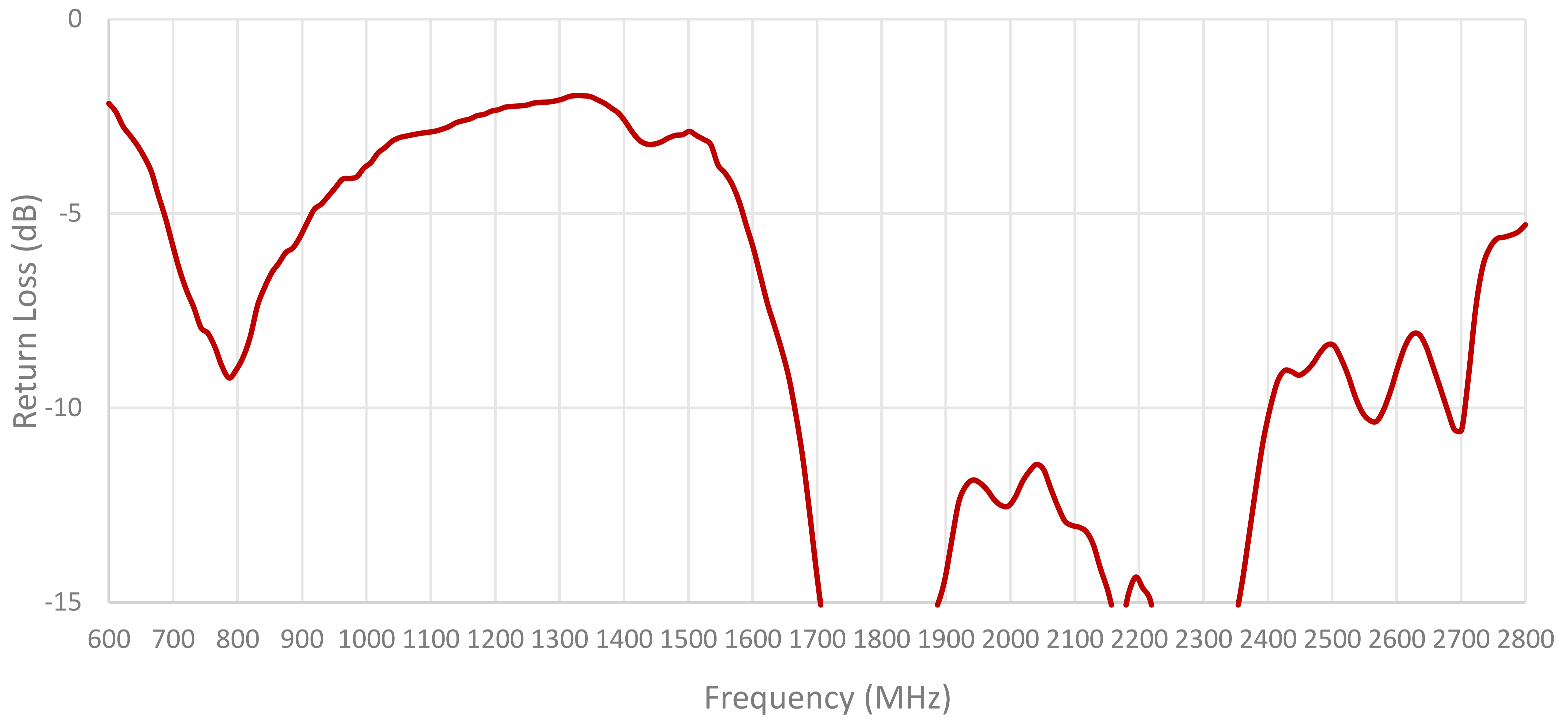

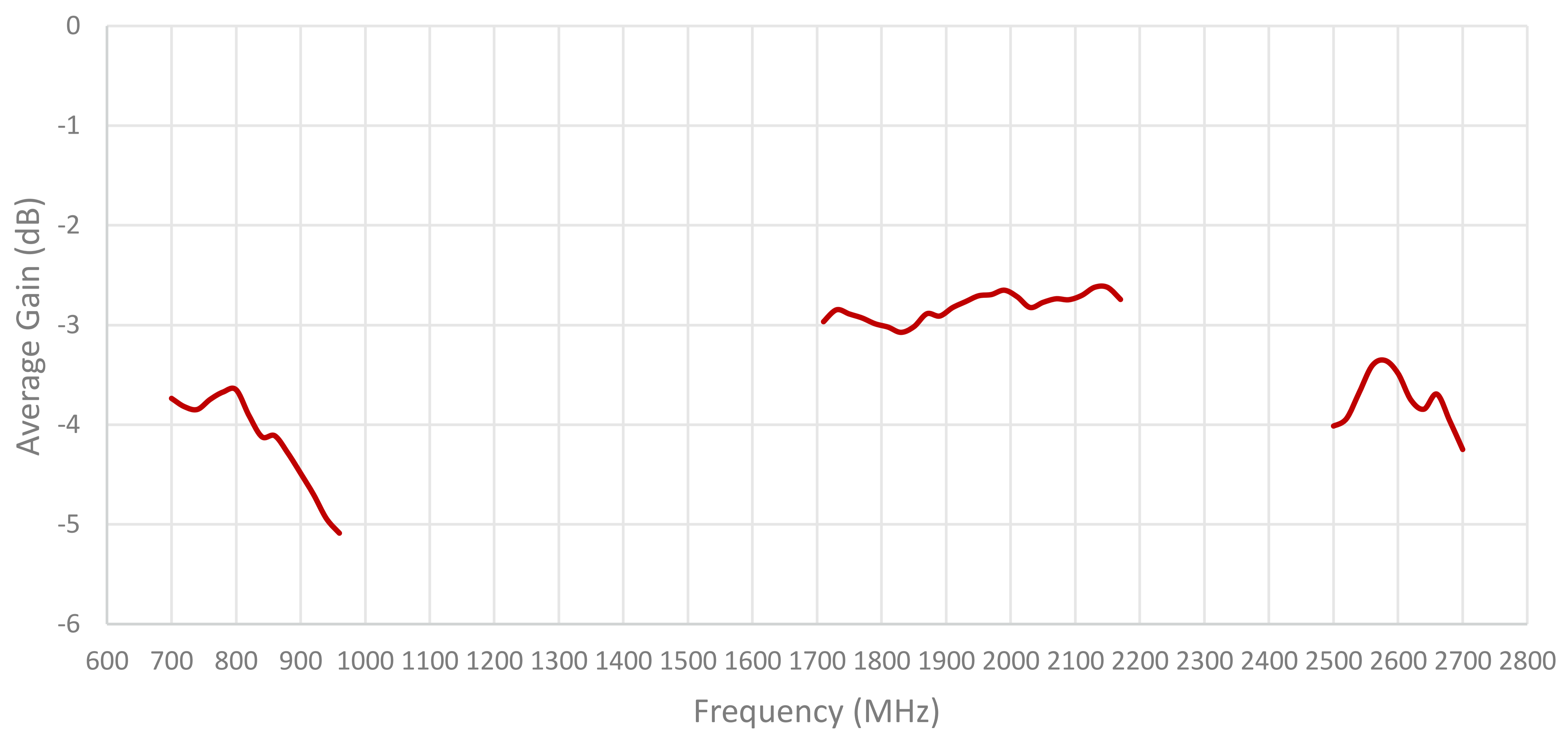
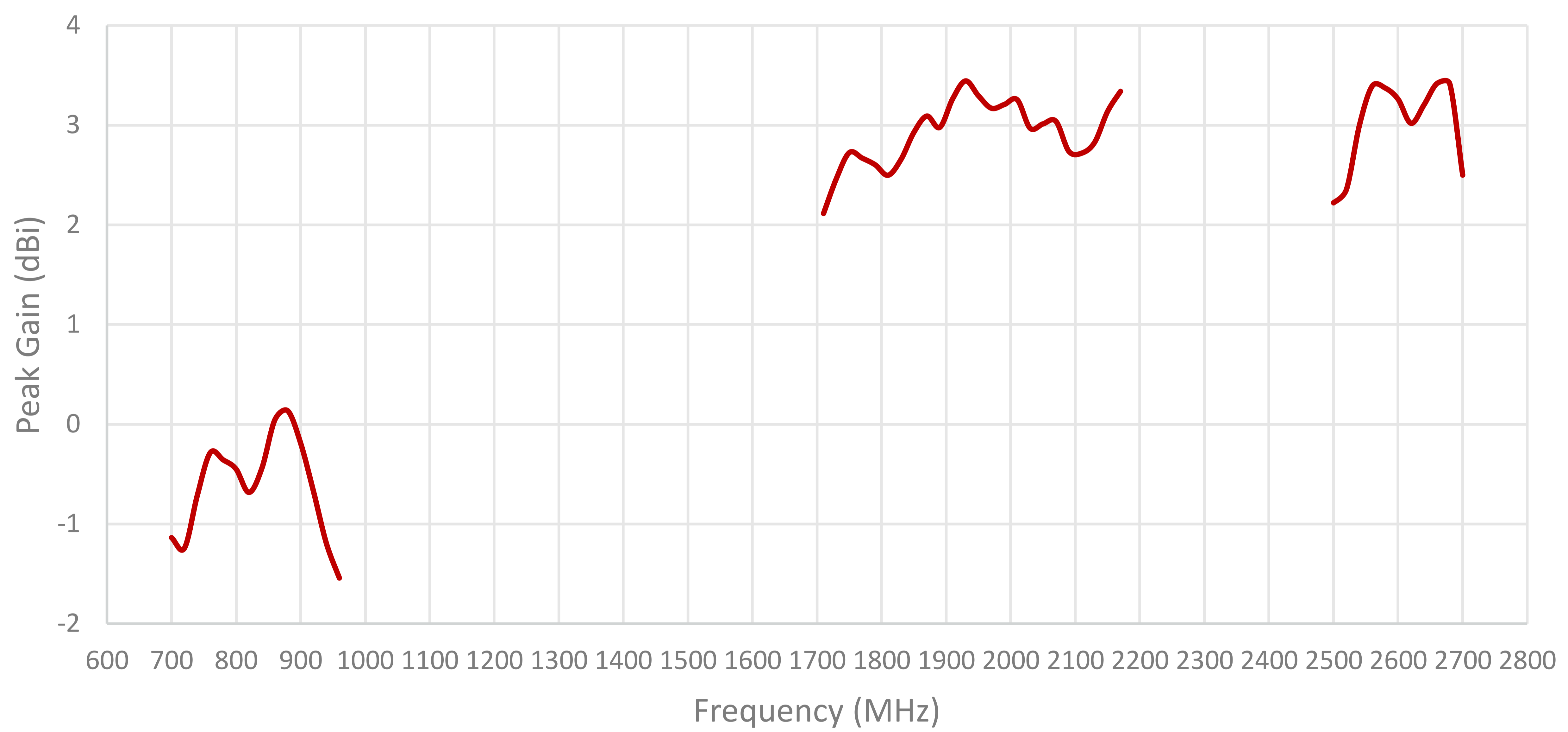
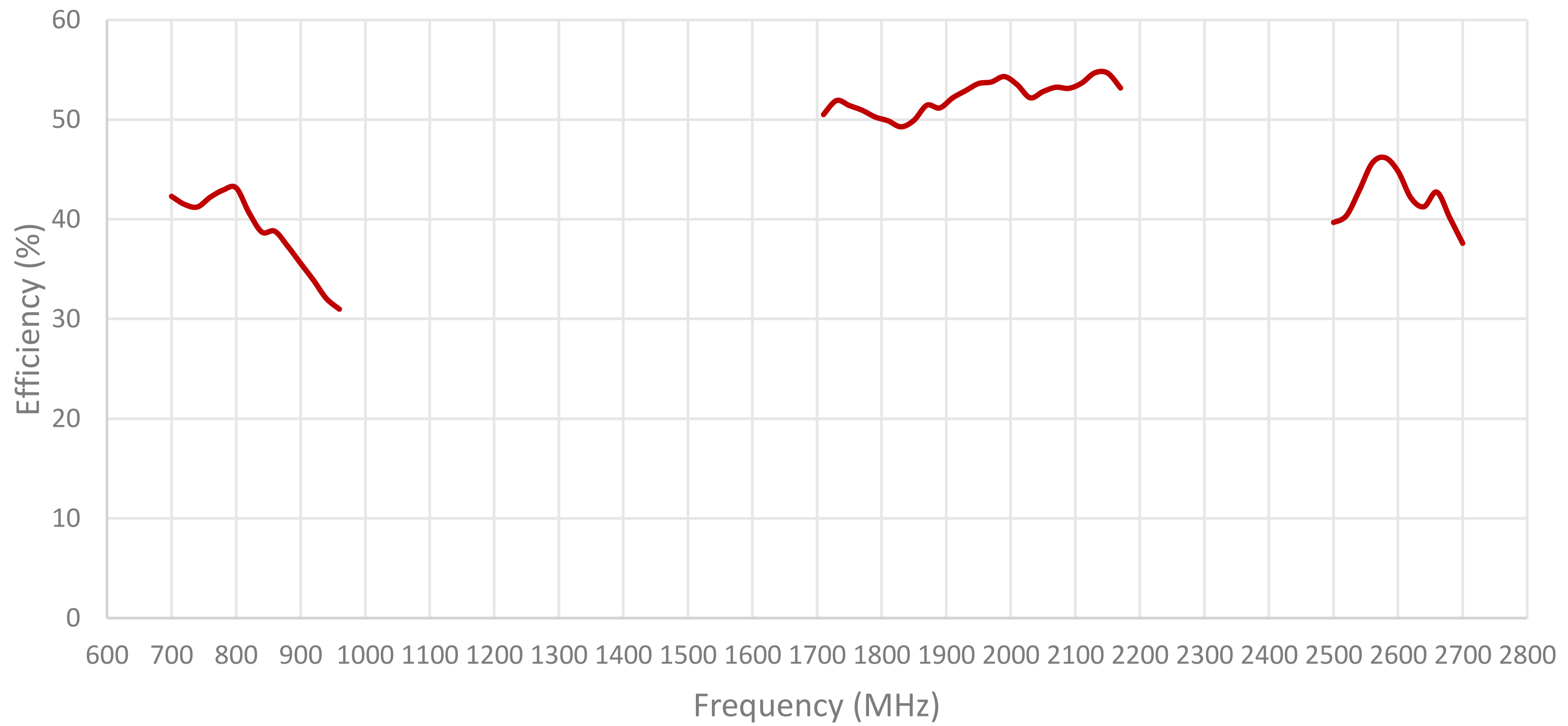

**ISOLATION FOR CABLES 1 AND 2**

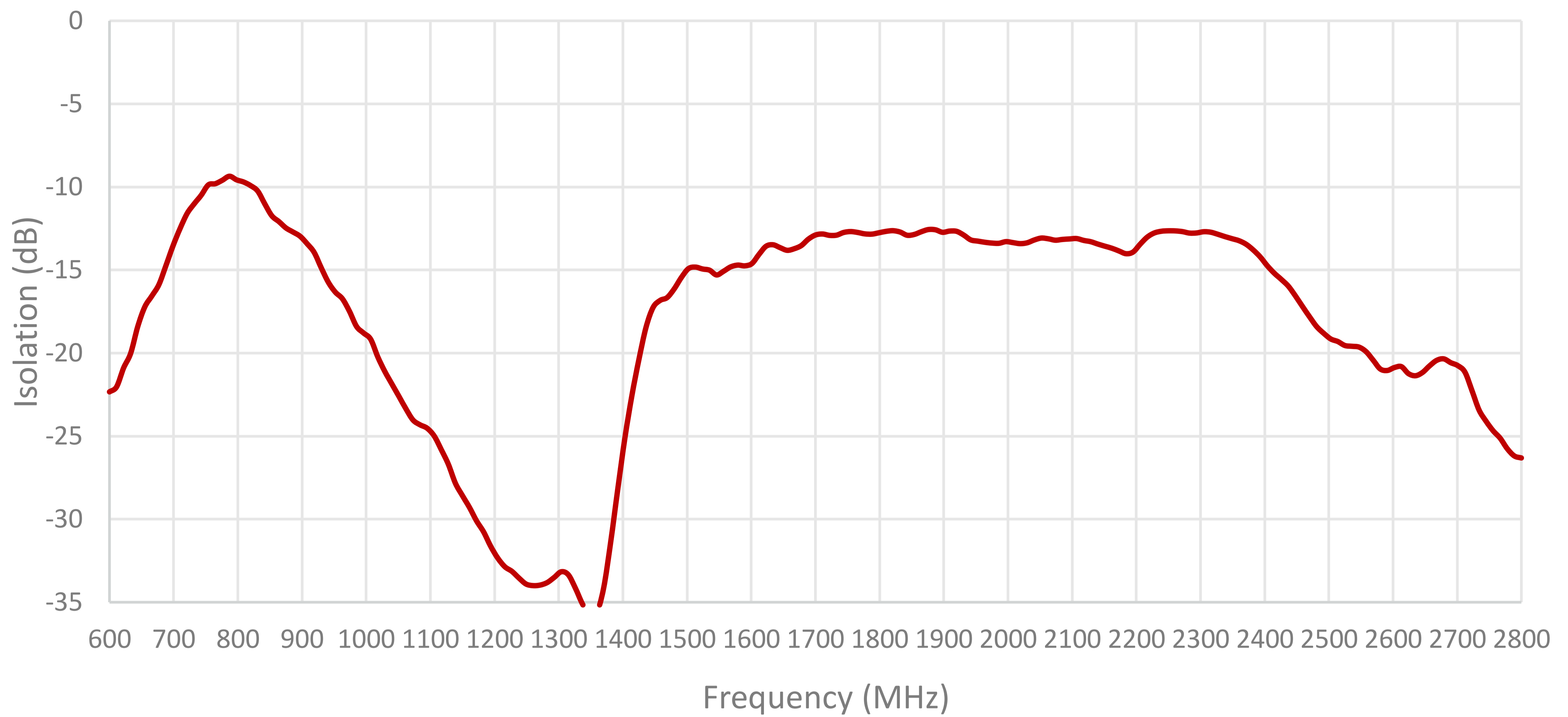

**ENVELOPE CORRELATION COEFFICIENT FOR CABLES 1 AND 2**

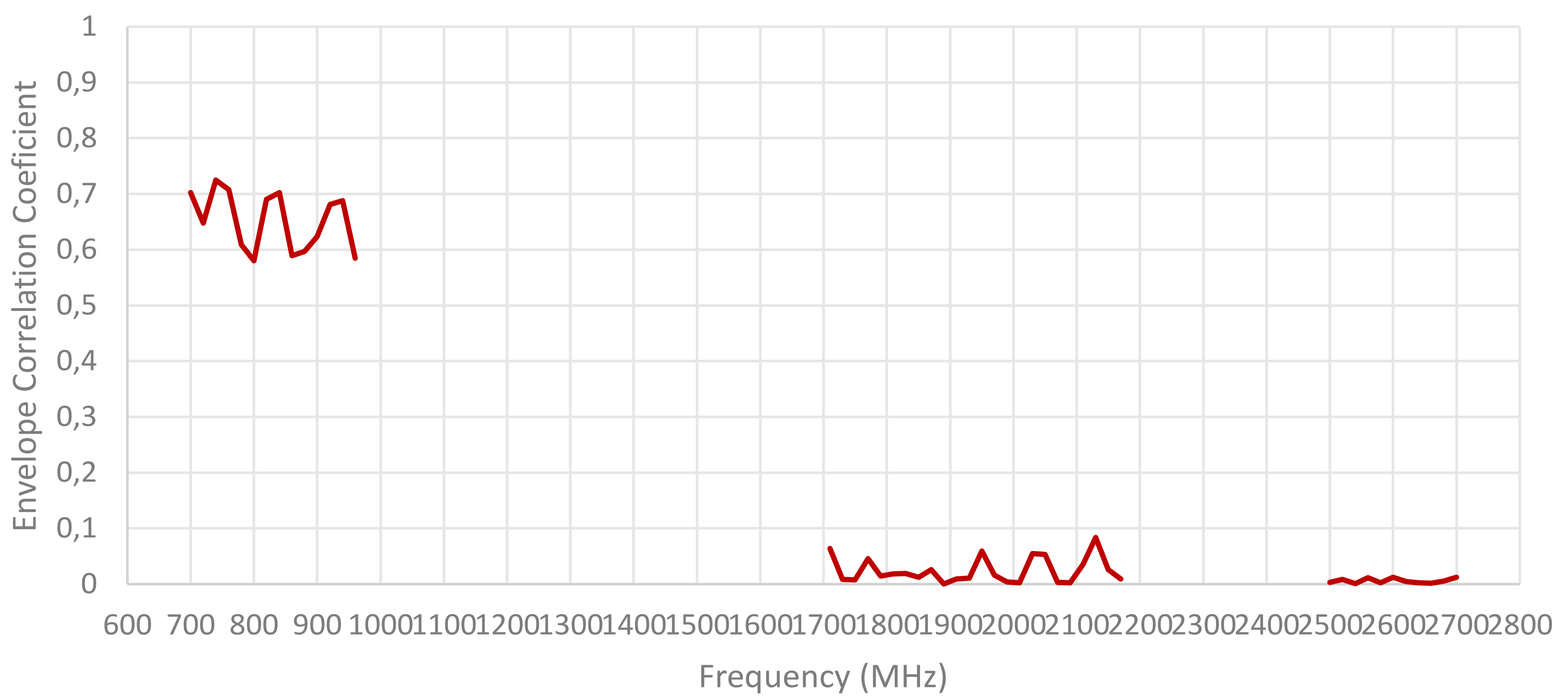



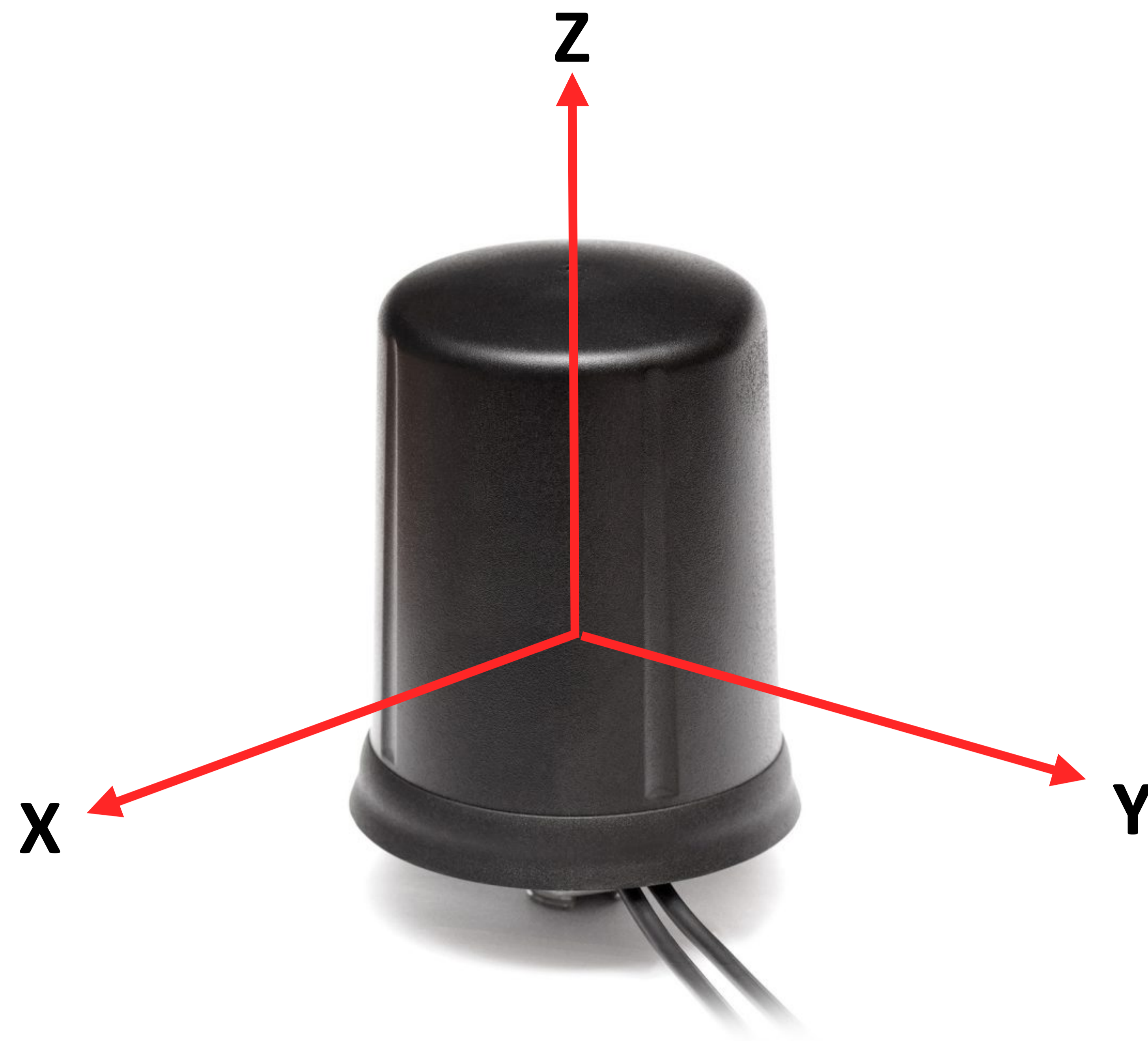

Radiation pattern reference

Cable 1: CELLULAR/LTE

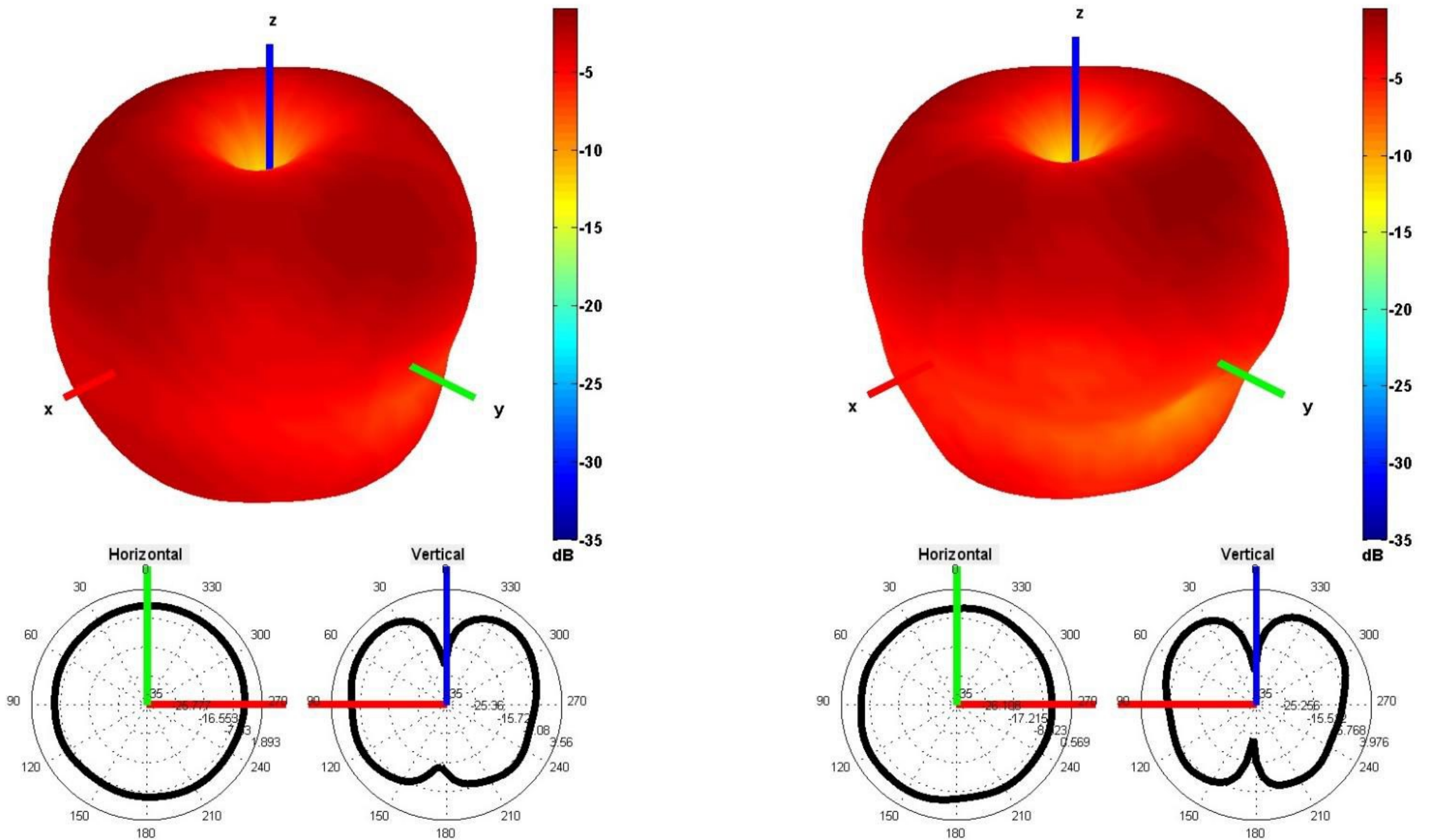

750 and 850 MHz Radiation pattern

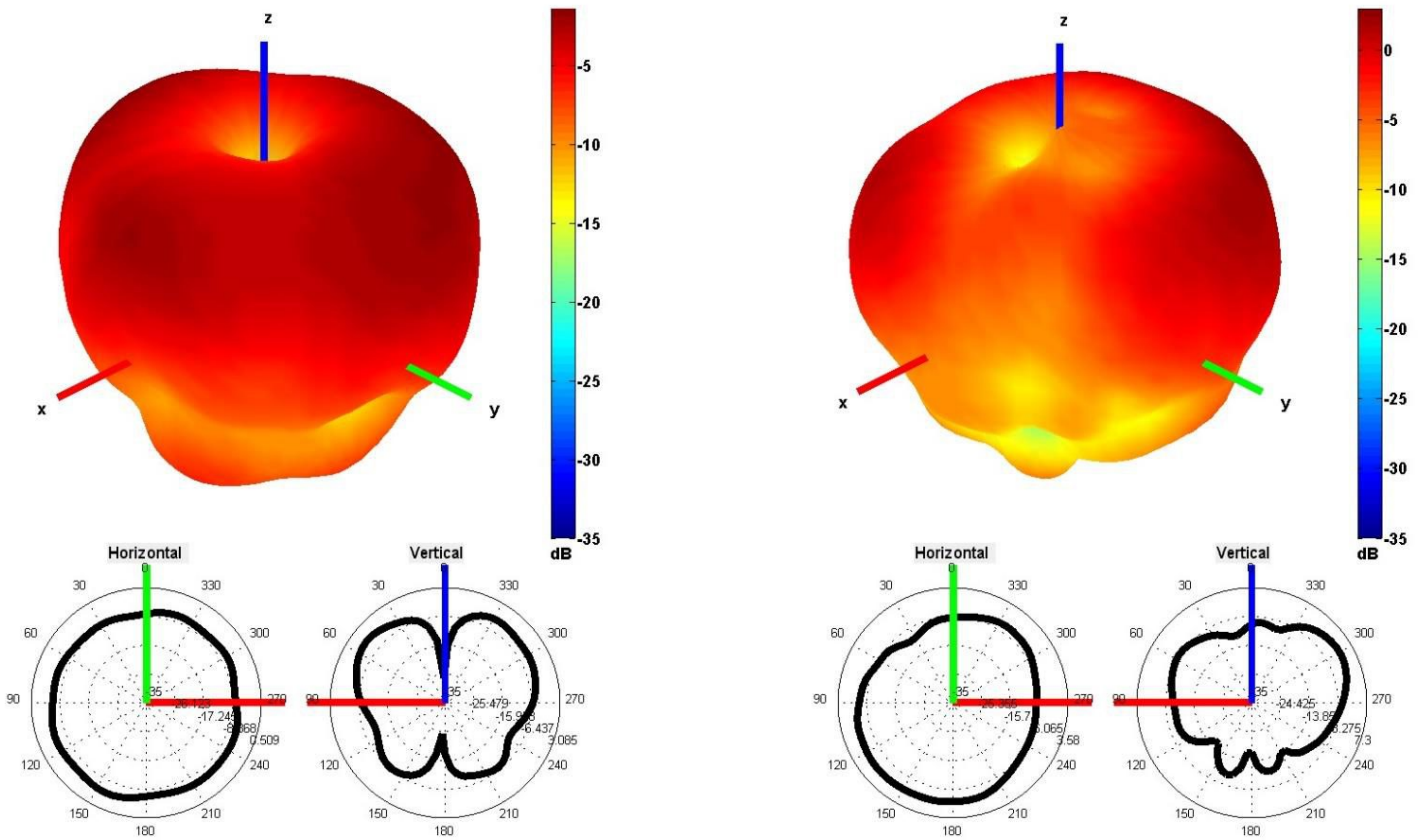

940 and 1750 MHz Radiation pattern

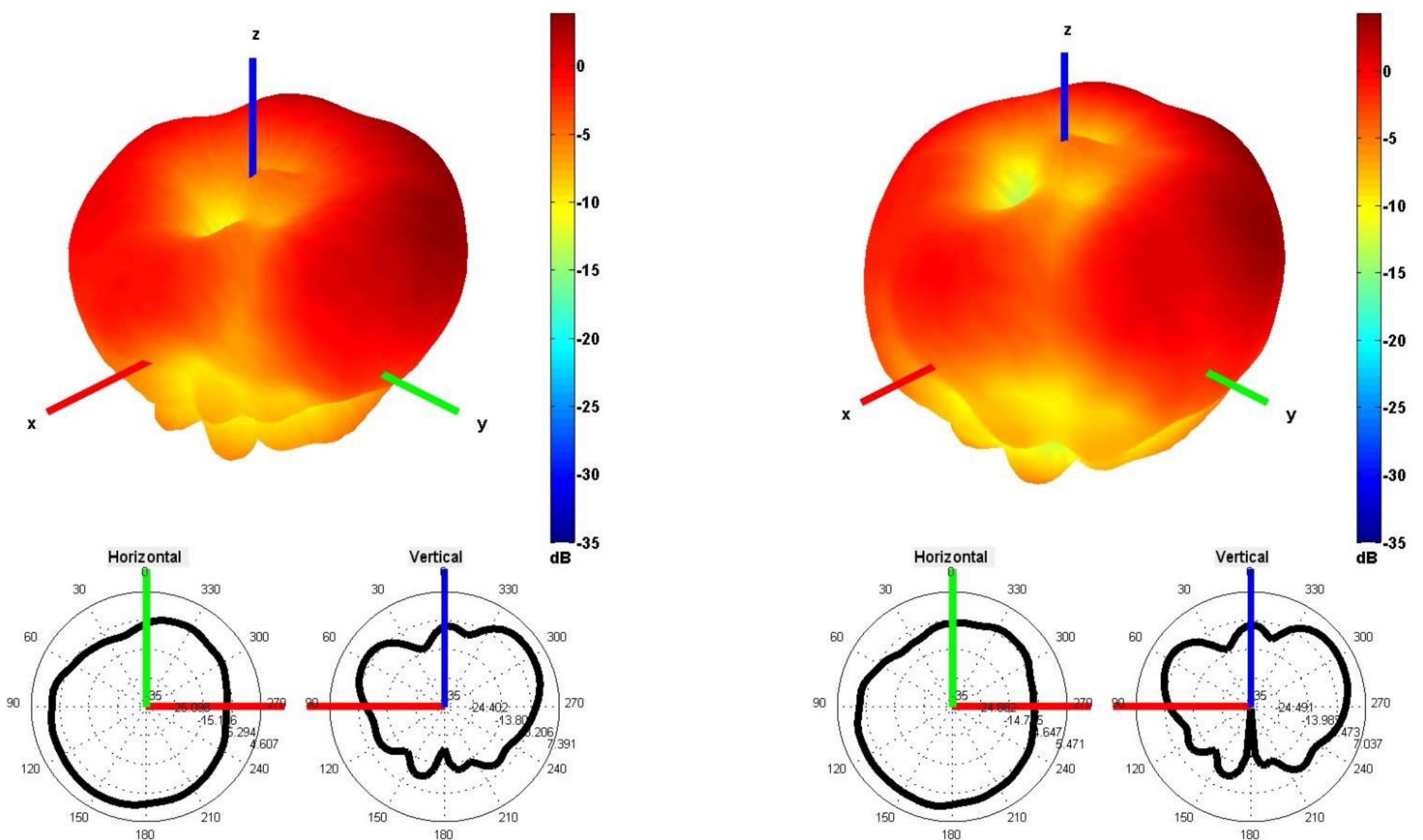

1850 and 1950 MHz Radiation pattern

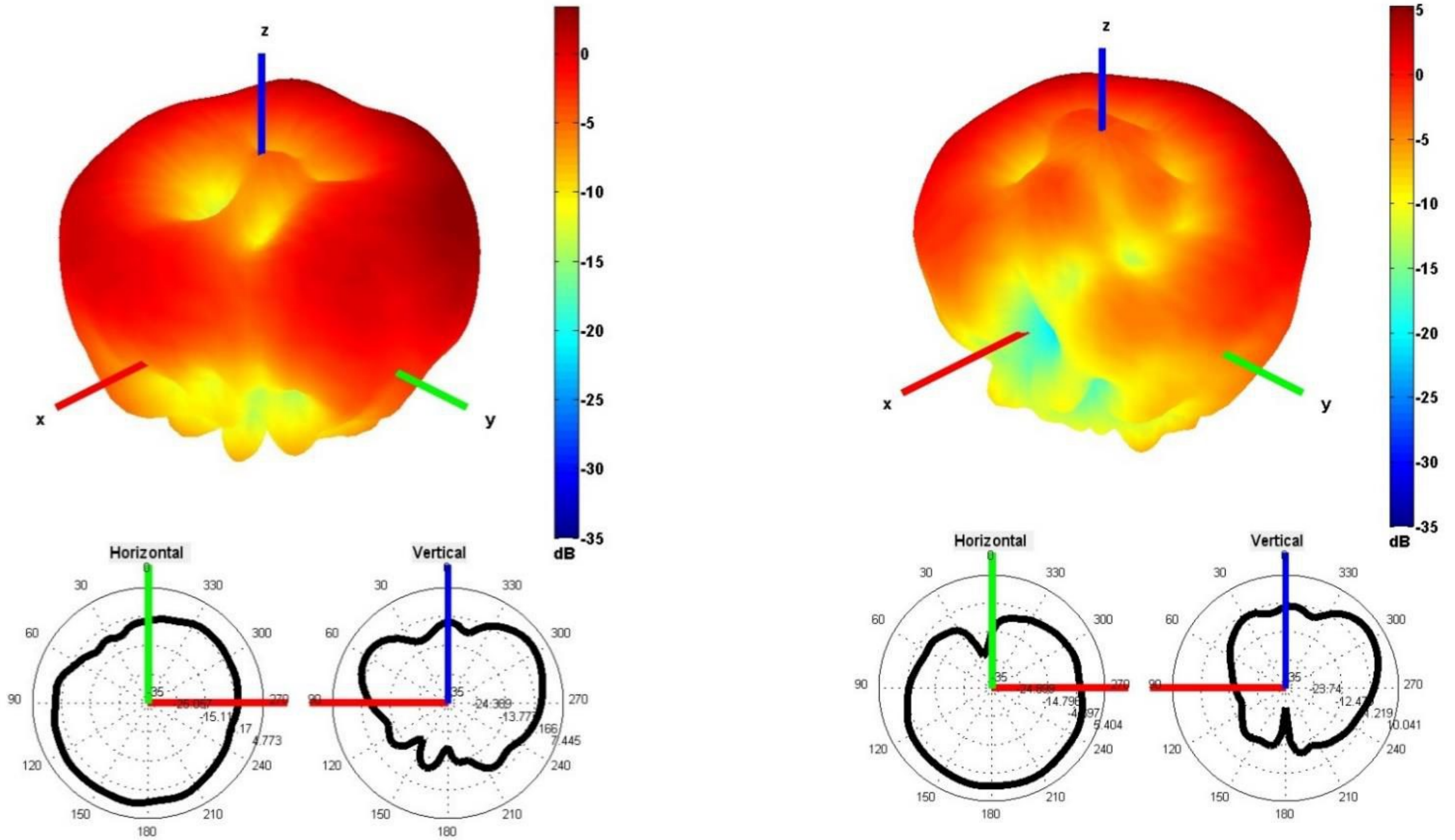

2100 and 2600 MHz Radiation pattern

Cable 2: CELLULAR/LTE

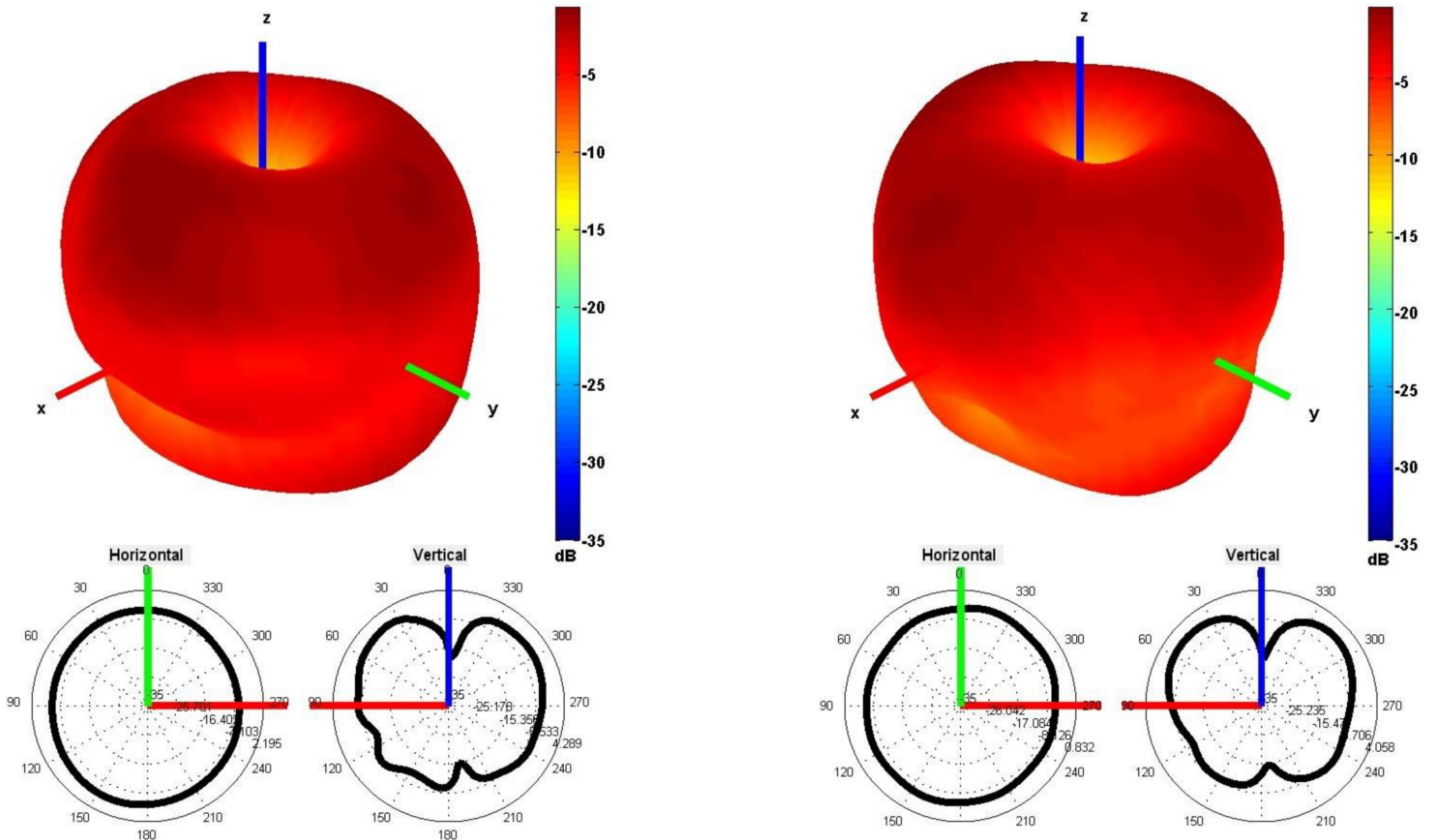

750 and 850 MHz Radiation pattern

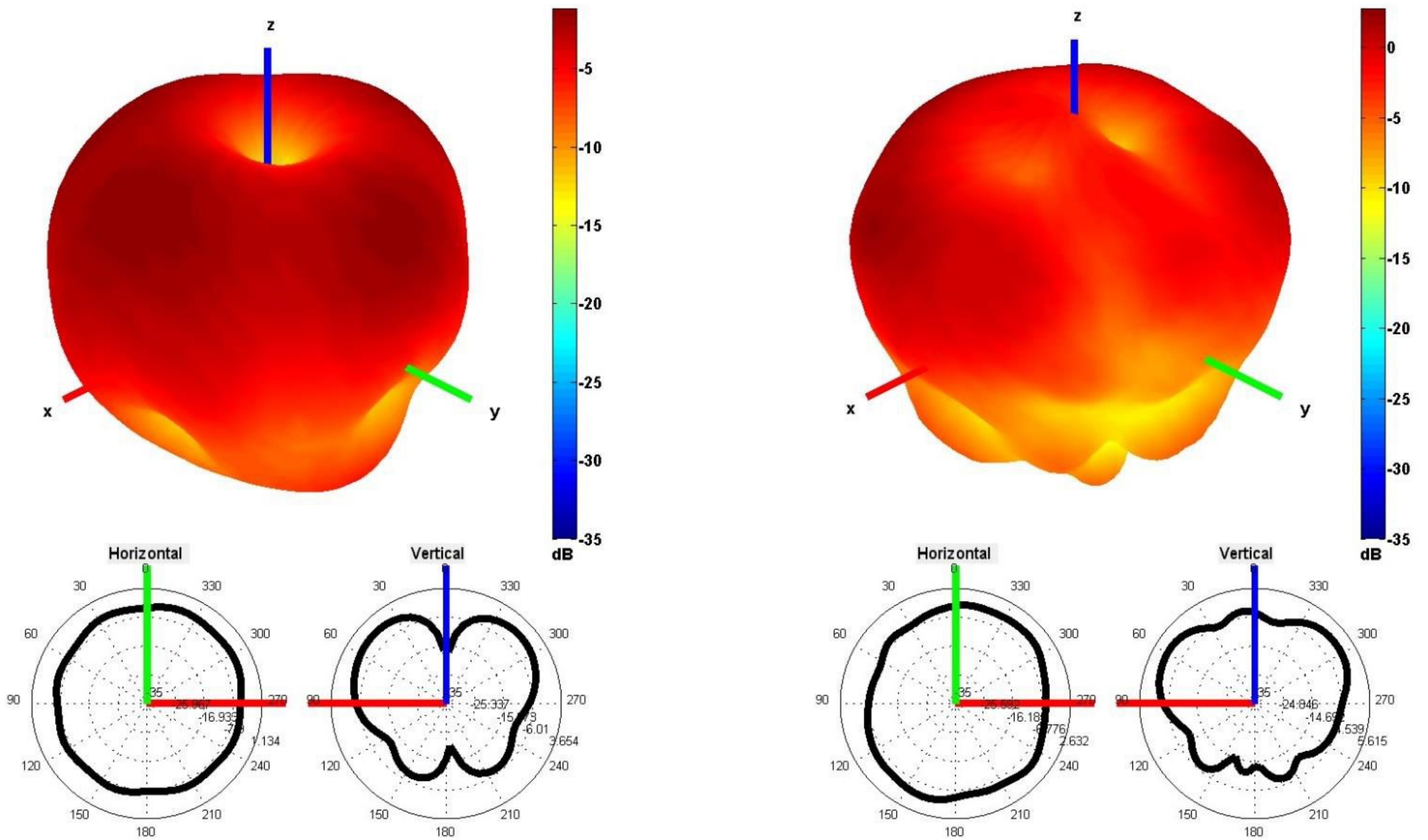

940 and 1750 MHz Radiation pattern

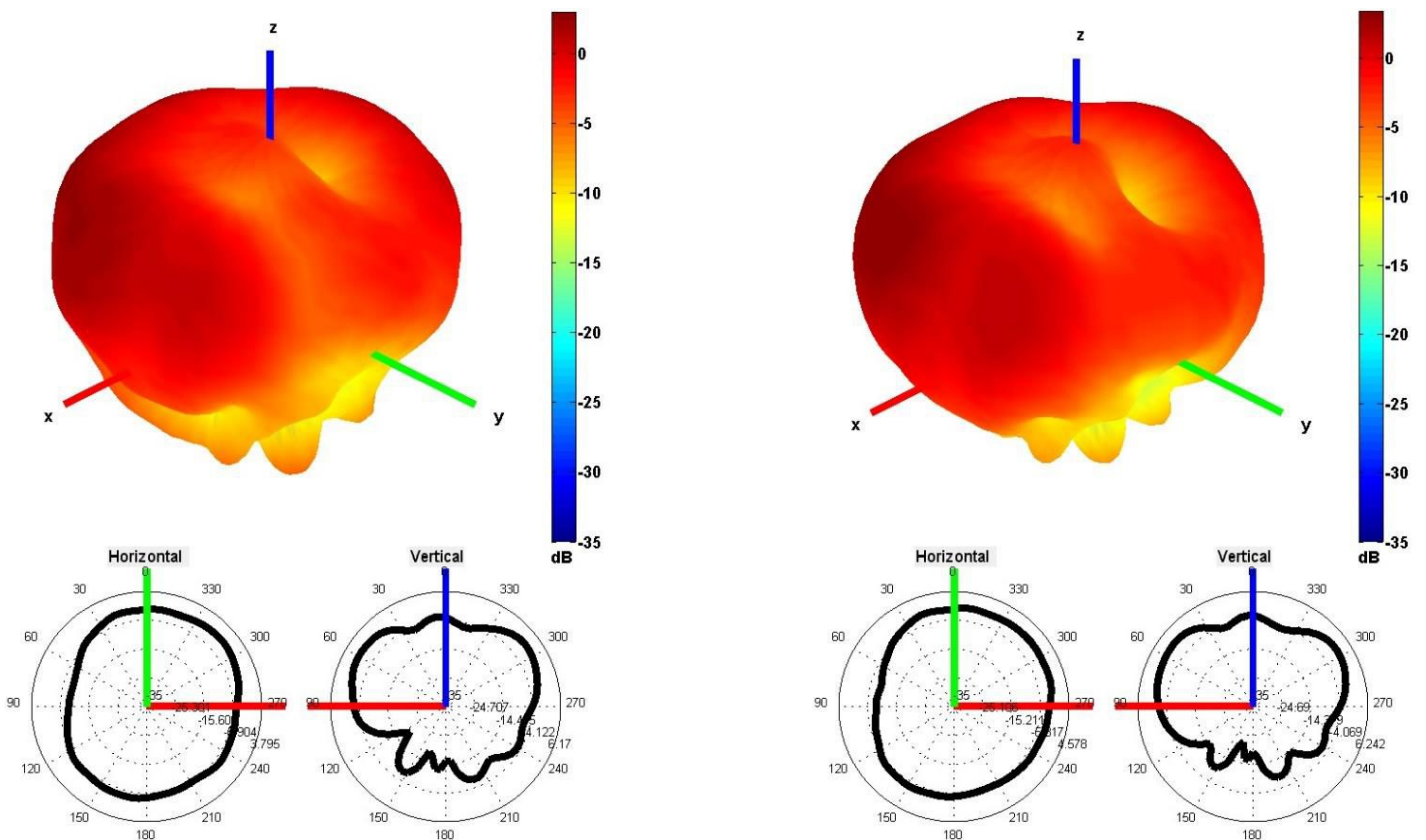

1850 and 1950 MHz Radiation pattern

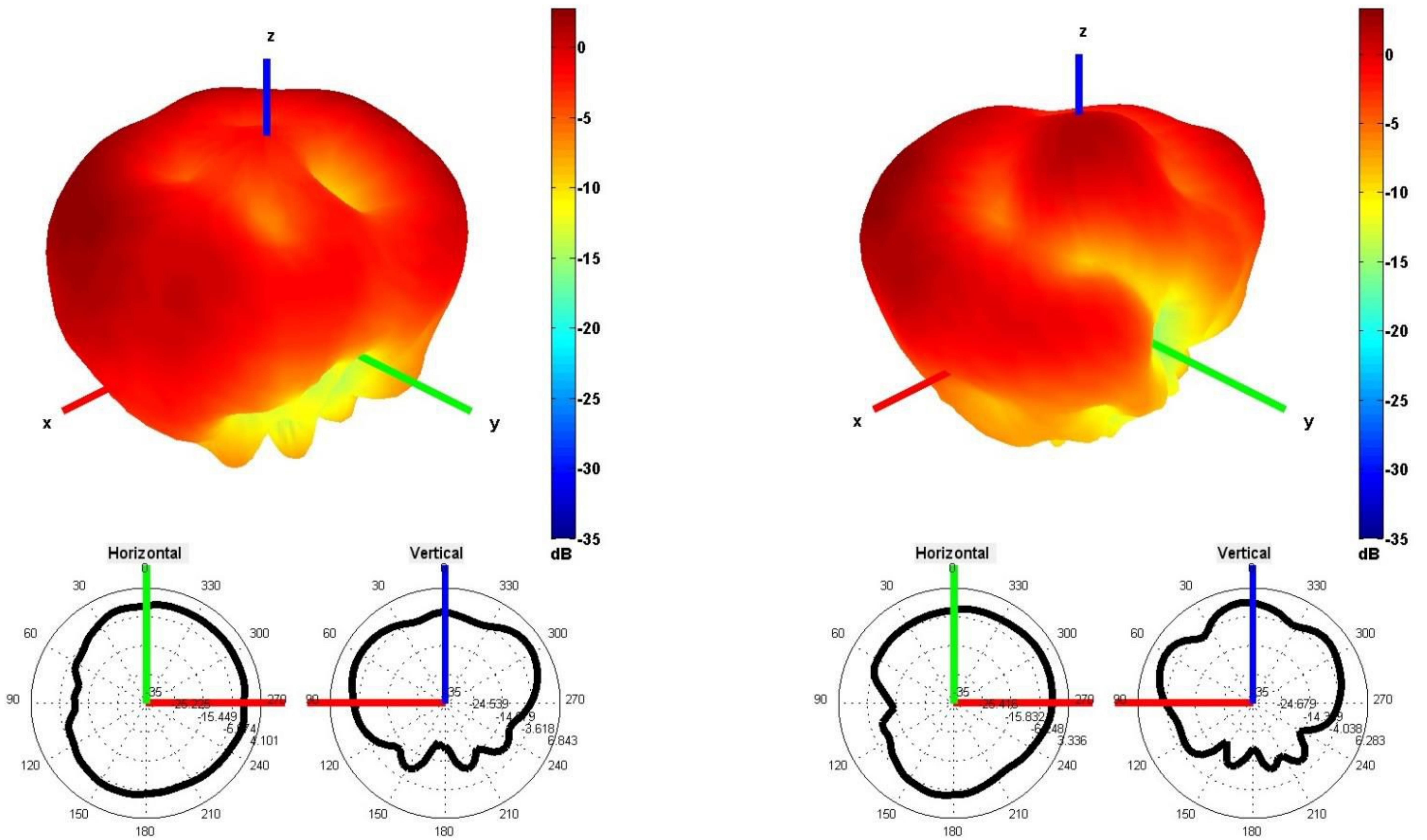

2100 and 2600 MHz Radiation pattern

## 4. Antenna drawings

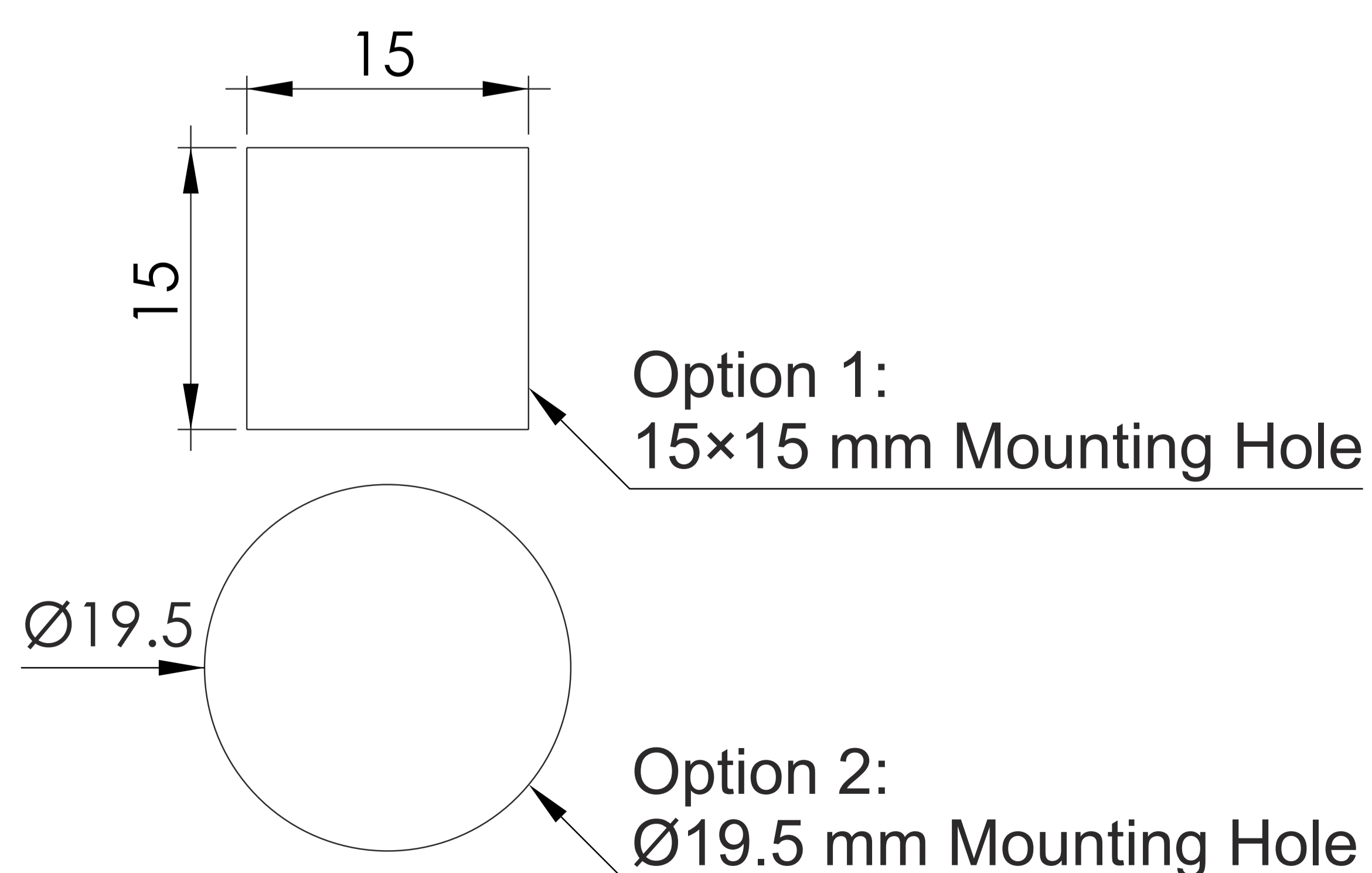
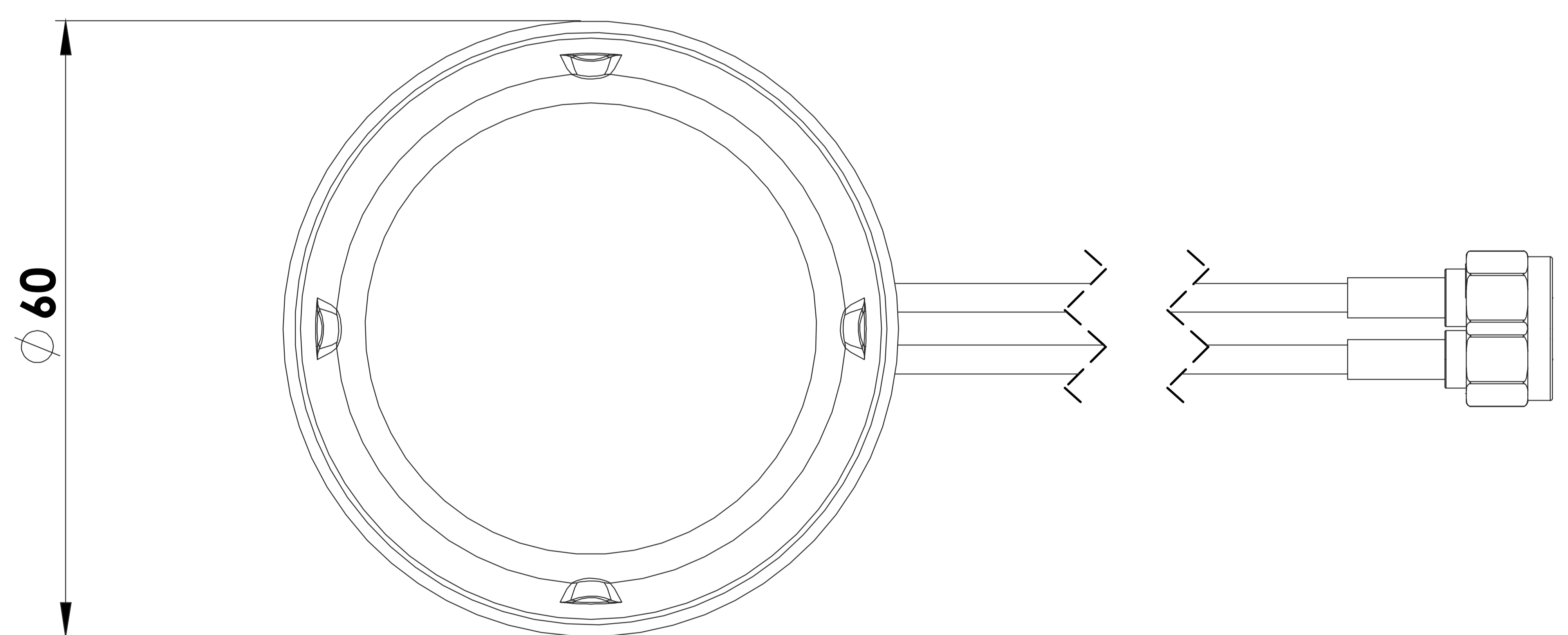
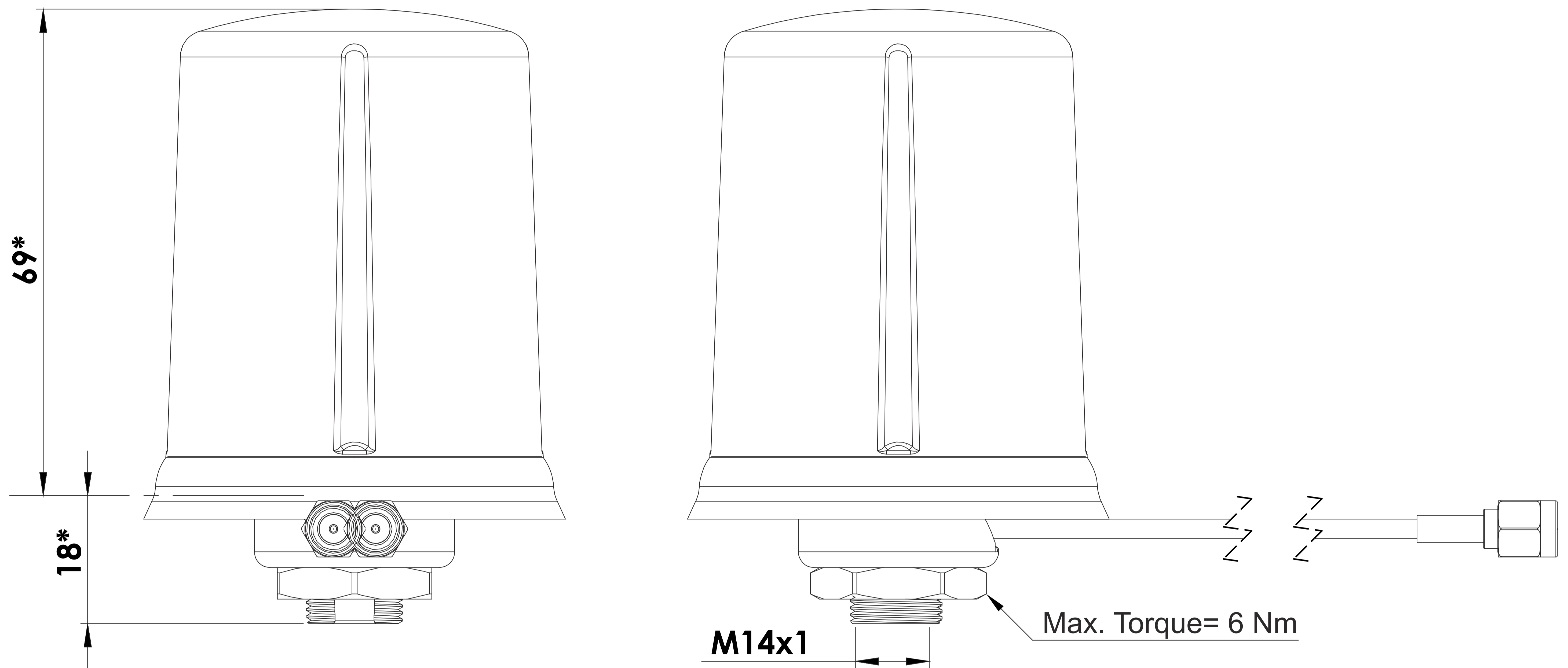

**Note: Dimensions are in millimeters**  
\*Dimensions are after mounting  
\*\*Max. Torque= 6 Nm

5. Antenna Images

